

4-BIT BIDIRECTIONAL VOLTAGE-LEVEL TRANSLATOR WITH AUTOMATIC DIRECTION SENSING AND ± 15 -kV ESD PROTECTION

Check for Samples: [TXB0104](#)

FEATURES

- 1.2 V to 3.6 V on A Port and 1.65 V to 5.5 V on B Port ($V_{CCA} \leq V_{CCB}$)
- V_{CC} Isolation Feature – If Either V_{CC} Input Is at GND, All Outputs Are in the High-Impedance State
- OE Input Circuit Referenced to V_{CCA}
- Low Power Consumption, 5- μ A Max I_{CC}
- I_{off} Supports Partial-Power-Down Mode Operation
- Latch-Up Performance Exceeds 100 mA Per JESD 78, Class II
- ESD Protection Exceeds JESD 22
 - A Port
 - 2500-V Human-Body Model (A114-B)
 - 1500-V Charged-Device Model (C101)
 - B Port
 - ± 15 -kV Human-Body Model (A114-B)
 - 1500-V Charged-Device Model (C101)

**GXU/ZXU PACKAGE
(TOP VIEW)**

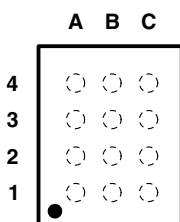

**TERMINAL ASSIGNMENTS
(GXU/ZXU Package)**

	A	B	C
4	A4	GND	B4
3	A3	OE	B3
2	A2	V_{CCA}	B2
1	A1	V_{CCB}	B1

**D OR PW PACKAGE
(TOP VIEW)**

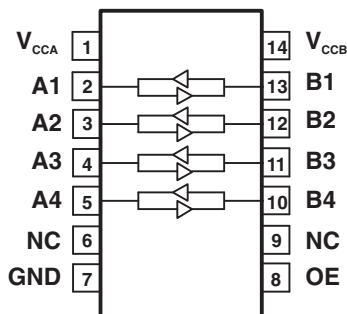

**RGY PACKAGE
(TOP VIEW)**

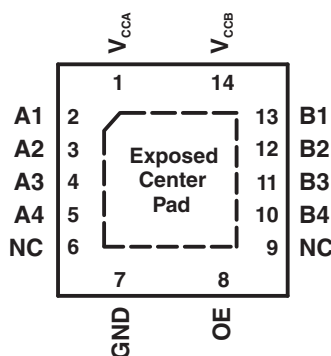

**RUT PACKAGE
(TOP VIEW)**

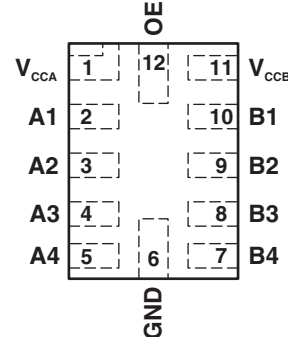

N.C. – No internal connection

For RGY, if the exposed center pad is used it must only be connected to as a secondary ground or left electrically open.

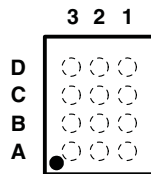

Please be aware that an important notice concerning availability, standard warranty, and use in critical applications of Texas Instruments semiconductor products and disclaimers thereto appears at the end of this data sheet.

**YZT PACKAGE
(TOP VIEW)**

**TERMINAL ASSIGNMENTS
(YZT Package)**

	3	2	1
D	A4	GND	B4
C	A3	OE	B3
B	A2	V _{CCA}	B2
A	A1	V _{CCB}	B1

DESCRIPTION/ORDERING INFORMATION

This 4-bit noninverting translator uses two separate configurable power-supply rails. The A port is designed to track V_{CCA}. V_{CCA} accepts any supply voltage from 1.2 V to 3.6 V. The B port is designed to track V_{CCB}. V_{CCB} accepts any supply voltage from 1.65 V to 5.5 V. This allows for universal low-voltage bidirectional translation between any of the 1.2-V, 1.5-V, 1.8-V, 2.5-V, 3.3-V, and 5-V voltage nodes. V_{CCA} should not exceed V_{CCB}.

When the output-enable (OE) input is low, all outputs are placed in the high-impedance state. To ensure the high-impedance state during power up or power down, OE should be tied to GND through a pull-down resistor; the minimum value of the resistor is determined by the current-sourcing capability of the driver.

The TXB0104 is designed so that the OE input circuit is supplied by V_{CCA}.

This device is fully specified for partial-power-down applications using I_{off}. The I_{off} circuitry disables the outputs, preventing damaging current backflow through the device when it is powered down.

ORDERING INFORMATION⁽¹⁾

T _A	PACKAGE ⁽²⁾		ORDERABLE PART NUMBER	TOP-SIDE MARKING ⁽³⁾
-40°C to 85°C	NanoFree™ — WCSP (DSBGA) 0.23-mm Large Bump — YZT (Pb-free) 0.625-mm max height	Reel of 3000	TXB0104YZTR	___ 2 K _
	UFBGA — GXU	Reel of 2500	TXB0104GXUR	YE04
	UFBGA — ZXU (Pb-Free)	Reel of 2500	TXB0104ZXUR	YE04
	QFN — RGY	Reel of 1000	TXB0104RGYR TXB0104RGYRG4	YE04
	uQFN — RUT	Reel of 1000	TXB0104RUTR	2KR
	SOIC — D	Tube of 50 Reel of 2500	TXB0104D	TXB0104
			TXB0104DG4	
			TXB0104DR	
			TXB0104DRG4	
	TSSOP — PW	Reel of 2000	TXB0104PWR	YE04
TXB0104PWRG4				

(1) For the most current package and ordering information, see the Package Option Addendum at the end of this document, or see the TI web site at www.ti.com.

(2) Package drawings, thermal data, and symbolization are available at www.ti.com/packageing.

(3) YZT: The actual top-side marking has three preceding characters to denote year, month, and sequence code, and one following character to designate the wafer fab/assembly site. Pin 1 identifier indicates solder-bump composition (1 = SnPb, • = Pb-free).

PIN DESCRIPTION

PIN NO.		BALL NO.		NAME	FUNCTION
D, PW, OR RGY	RUT	GXU/ ZXU	YZT		
1	1	B2	B2	V _{CCA}	A-port supply voltage $1.2\text{ V} \leq V_{CCA} \leq 3.6\text{ V}$ and $V_{CCA} \leq V_{CCB}$.
2	2	A1	A3	A1	Input/output 1. Referenced to V _{CCA} .
3	3	A2	B3	A2	Input/output 2. Referenced to V _{CCA} .
4	4	A3	C3	A3	Input/output 3. Referenced to V _{CCA} .
5	5	A4	D3	A4	Input/output 4. Referenced to V _{CCA} .
6	–	–	–	NC	No connection. Not internally connected.
7	6	B4	D2	GND	Ground
8	12	B3	C2	OE	3-state output-mode enable. Pull OE low to place all outputs in 3-state mode. Referenced to V _{CCA} .
9	–	–	–	NC	No connection. Not internally connected.
10	7	C4	D1	B4	Input/output 4. Referenced to V _{CCB} .
11	8	C3	C1	B3	Input/output 3. Referenced to V _{CCB} .
12	9	C2	B1	B2	Input/output 2. Referenced to V _{CCB} .
13	10	C1	A1	B1	Input/output 1. Referenced to V _{CCB} .
14	11	B1	A2	V _{CCB}	B-port supply voltage $1.65\text{ V} \leq V_{CCB} \leq 5.5\text{ V}$.

ABSOLUTE MAXIMUM RATINGS⁽¹⁾

over operating free-air temperature range (unless otherwise noted)

		MIN	MAX	UNIT	
V _{CCA}	Supply voltage range	–0.5	4.6	V	
V _{CCB}		–0.5	6.5		
V _I	Input voltage range	A port	–0.5	4.6	V
		B port	–0.5	6.5	
V _O	Voltage range applied to any output in the high-impedance or power-off state	A port	–0.5	4.6	V
		B port	–0.5	6.5	
V _O	Voltage range applied to any output in the high or low state ⁽²⁾	A port	–0.5	V _{CCA} + 0.5	V
		B port	–0.5	V _{CCB} + 0.5	
I _{IK}	Input clamp current	V _I < 0		–50	mA
I _{OK}	Output clamp current	V _O < 0		–50	mA
I _O	Continuous output current			±50	mA
	Continuous current through V _{CCA} , V _{CCB} , or GND			±100	mA
T _{stg}	Storage temperature range	–65	150	°C	

- (1) Stresses beyond those listed under "absolute maximum ratings" may cause permanent damage to the device. These are stress ratings only, and functional operation of the device at these or any other conditions beyond those indicated under "recommended operating conditions" is not implied. Exposure to absolute-maximum-rated conditions for extended periods may affect device reliability.
- (2) The value of V_{CCA} and V_{CCB} are provided in the recommended operating conditions table.

THERMAL IMPEDANCE RATINGS

			UNIT
θ_{JA}	Package thermal impedance	D package ⁽¹⁾	86
		GXU/ZXU package ⁽¹⁾	129
		PW package ⁽¹⁾	113
		RGY package ⁽²⁾	47
		RUT package	TBD
		YZT package	90

(1) The package thermal impedance is calculated in accordance with JESD 51-7.

(2) The package thermal impedance is calculated in accordance with JESD 51-5.

RECOMMENDED OPERATING CONDITIONS⁽¹⁾ (2)

		V_{CCA}	V_{CCB}	MIN	MAX	UNIT	
V_{CCA}	Supply voltage			1.2	3.6	V	
V_{CCB}				1.65	5.5		
V_{IH}	High-level input voltage	Data inputs	1.2 V to 3.6 V	1.65 V to 5.5 V	$V_{CCI} \times 0.65^{(3)}$	V_{CCI}	V
		OE	1.2 V to 3.6 V	1.65 V to 5.5 V	$V_{CCA} \times 0.65$	5.5	
V_{IL}	Low-level input voltage	Data inputs	1.2 V to 5.5 V	1.65 V to 5.5 V	0	$V_{CCI} \times 0.35^{(3)}$	V
		OE	1.2 V to 3.6 V	1.65 V to 5.5 V	0	$V_{CCA} \times 0.35$	
V_O	Voltage range applied to any output in the high-impedance or power-off state	A-port	1.2 V to 3.6 V	1.65 V to 5.5 V	0	3.6	V
		B-port			0	5.5	
$\Delta t/\Delta v$	Input transition rise or fall rate	A-port inputs	1.2 V to 3.6 V	1.65 V to 5.5 V		40	ns/V
		B-port inputs	1.2 V to 3.6 V	1.65 V to 3.6 V		40	
				4.5 V to 5.5 V		30	
T_A	Operating free-air temperature			-40	85	°C	

(1) The A and B sides of an unused data I/O pair must be held in the same state, i.e., both at V_{CCI} or both at GND.

(2) V_{CCA} must be less than or equal to V_{CCB} and must not exceed 3.6 V.

(3) V_{CCI} is the supply voltage associated with the input port.

ELECTRICAL CHARACTERISTICS^{(1) (2)}

over recommended operating free-air temperature range (unless otherwise noted)

PARAMETER		TEST CONDITIONS	V _{CCA}	V _{CCB}	T _A = 25°C			–40°C to 85°C		UNIT
					MIN	TYP	MAX	MIN	MAX	
V _{OHA}		I _{OH} = –20 μA	1.2 V		1.1			V _{CCA} – 0.4	V	
			1.4 V to 3.6 V							
V _{OLA}		I _{OL} = 20 μA	1.2 V		0.9			0.4	V	
			1.4 V to 3.6 V							
V _{OHB}		I _{OH} = –20 μA		1.65 V to 5.5 V				V _{CCB} – 0.4	V	
V _{OLB}		I _{OL} = 20 μA		1.65 V to 5.5 V				0.4	V	
I _I	OE	V _I = V _{CCI} or GND	1.2 V to 3.6 V	1.65 V to 5.5 V	±1			±2	μA	
I _{off}	A port	V _I or V _O = 0 to 3.6 V	0 V	0 V to 5.5 V	±1			±2	μA	
	B port	V _I or V _O = 0 to 5.5 V	0 V to 3.6 V	0 V	±1			±2		
I _{OZ}	A or B port	OE = GND	1.2 V to 3.6 V	1.65 V to 5.5 V	±1			±2	μA	
I _{CCA}		V _I = V _{CCI} or GND, I _O = 0	1.2 V	1.65 V to 5.5 V	0.06				μA	
			1.4 V to 3.6 V	1.65 V to 5.5 V				5		
			3.6 V	0 V				2		
			0 V	5.5 V				–2		
I _{CCB}		V _I = V _{CCB} or GND, I _O = 0	1.2 V	1.65 V to 5.5 V	3.4				μA	
			1.4 V to 3.6 V	1.65 V to 5.5 V				5		
			3.6 V	0 V				–2		
			0 V	5.5 V				2		
I _{CCA} + I _{CCB}		V _I = V _{CCI} or GND, I _O = 0	1.2 V	1.65 V to 5.5 V	3.5				μA	
			1.4 V to 3.6 V	1.65 V to 5.5 V				10		
I _{CCZA}		V _I = V _{CCI} or GND, I _O = 0, OE = GND	1.2 V	1.65 V to 5.5 V	0.05				μA	
			1.4 V to 3.6 V	1.65 V to 5.5 V				5		
I _{CCZB}		V _I = V _{CCB} or GND, I _O = 0, OE = GND	1.2 V	1.65 V to 5.5 V	3.3				μA	
			1.4 V to 3.6 V	1.65 V to 5.5 V				5		
C _i	OE		1.2 V to 3.6 V	1.65 V to 5.5 V	3			4	pF	
C _{io}	A port		1.2 V to 3.6 V	1.65 V to 5.5 V	5			6	pF	
	B port	11			14					

 (1) V_{CCI} is the supply voltage associated with the input port.

 (2) V_{CCO} is the supply voltage associated with the output port.

TIMING REQUIREMENTS $T_A = 25^\circ\text{C}$, $V_{CCA} = 1.2\text{ V}$

		$V_{CCB} = 1.8\text{ V}$	$V_{CCB} = 2.5\text{ V}$	$V_{CCB} = 3.3\text{ V}$	$V_{CCB} = 5\text{ V}$	UNIT
		TYP	TYP	TYP	TYP	
Data rate		20	20	20	20	Mbps
t_w	Pulse duration	Data inputs	50	50	50	ns

TIMING REQUIREMENTSover recommended operating free-air temperature range, $V_{CCA} = 1.5\text{ V} \pm 0.1\text{ V}$ (unless otherwise noted)

		$V_{CCB} = 1.8\text{ V} \pm 0.15\text{ V}$		$V_{CCB} = 2.5\text{ V} \pm 0.2\text{ V}$		$V_{CCB} = 3.3\text{ V} \pm 0.3\text{ V}$		$V_{CCB} = 5\text{ V} \pm 0.5\text{ V}$		UNIT
		MIN	MAX	MIN	MAX	MIN	MAX	MIN	MAX	
Data rate		40		40		40		40		Mbps
t_w	Pulse duration	25		25		25		25		ns

TIMING REQUIREMENTSover recommended operating free-air temperature range, $V_{CCA} = 1.8\text{ V} \pm 0.15\text{ V}$ (unless otherwise noted)

		$V_{CCB} = 1.8\text{ V} \pm 0.15\text{ V}$		$V_{CCB} = 2.5\text{ V} \pm 0.2\text{ V}$		$V_{CCB} = 3.3\text{ V} \pm 0.3\text{ V}$		$V_{CCB} = 5\text{ V} \pm 0.5\text{ V}$		UNIT
		MIN	MAX	MIN	MAX	MIN	MAX	MIN	MAX	
Data rate		60		60		60		60		Mbps
t_w	Pulse duration	17		17		17		17		ns

TIMING REQUIREMENTSover recommended operating free-air temperature range, $V_{CCA} = 2.5\text{ V} \pm 0.2\text{ V}$ (unless otherwise noted)

		$V_{CCB} = 2.5\text{ V} \pm 0.2\text{ V}$		$V_{CCB} = 3.3\text{ V} \pm 0.3\text{ V}$		$V_{CCB} = 5\text{ V} \pm 0.5\text{ V}$		UNIT
		MIN	MAX	MIN	MAX	MIN	MAX	
Data rate		100		100		100		Mbps
t_w	Pulse duration	10		10		10		ns

TIMING REQUIREMENTSover recommended operating free-air temperature range, $V_{CCA} = 3.3\text{ V} \pm 0.3\text{ V}$ (unless otherwise noted)

		$V_{CCB} = 3.3\text{ V} \pm 0.3\text{ V}$		$V_{CCB} = 5\text{ V} \pm 0.5\text{ V}$		UNIT
		MIN	MAX	MIN	MAX	
Data rate		100		100		Mbps
t_w	Pulse duration	10		10		ns

SWITCHING CHARACTERISTICS

 $T_A = 25^\circ\text{C}$, $V_{CCA} = 1.2\text{ V}$

PARAMETER	FROM (INPUT)	TO (OUTPUT)	$V_{CCB} = 1.8\text{ V}$	$V_{CCB} = 2.5\text{ V}$	$V_{CCB} = 3.3\text{ V}$	$V_{CCB} = 5\text{ V}$	UNIT
			TYP	TYP	TYP	TYP	
t_{pd}	A	B	6.9	5.7	5.3	5.5	ns
	B	A	7.4	6.4	6	5.8	
t_{en}	OE	A	1	1	1	1	μs
		B	1	1	1	1	
t_{dis}	OE	A	18	15	14	14	ns
		B	20	17	16	16	
t_{rA} , t_{fA}	A-port rise and fall times		4.2	4.2	4.2	4.2	ns
t_{rB} , t_{fB}	B-port rise and fall times		2.1	1.5	1.2	1.1	ns
$t_{SK(O)}$	Channel-to-channel skew		0.4	0.5	0.5	1.4	ns
Max data rate			20	20	20	20	Mbps

SWITCHING CHARACTERISTICS

 over recommended operating free-air temperature range, $V_{CCA} = 1.5\text{ V} \pm 0.1\text{ V}$ (unless otherwise noted)

PARAMETER	FROM (INPUT)	TO (OUTPUT)	$V_{CCB} = 1.8\text{ V} \pm 0.15\text{ V}$		$V_{CCB} = 2.5\text{ V} \pm 0.2\text{ V}$		$V_{CCB} = 3.3\text{ V} \pm 0.3\text{ V}$		$V_{CCB} = 5\text{ V} \pm 0.5\text{ V}$		UNIT
			MIN	MAX	MIN	MAX	MIN	MAX	MIN	MAX	
t_{pd}	A	B	1.4	12.9	1.2	10.1	1.1	10	0.8	9.9	ns
	B	A	0.9	14.2	0.7	12	0.4	11.7	0.3	13.7	
t_{en}	OE	A		1		1		1		1	μs
		B		1		1		1		1	
t_{dis}	OE	A	5.9	31	5.7	25.9	5.6	23	5.7	22.4	ns
		B	5.4	30.3	4.9	22.8	4.8	20	4.9	19.5	
t_{rA} , t_{fA}	A-port rise and fall times		1.4	5.1	1.4	5.1	1.4	5.1	1.4	5.1	ns
t_{rB} , t_{fB}	B-port rise and fall times		0.9	4.5	0.6	3.2	0.5	2.8	0.4	2.7	ns
$t_{SK(O)}$	Channel-to-channel skew			0.5		0.5		0.5		0.5	ns
Max data rate			40		40		40		40		Mbps

SWITCHING CHARACTERISTICS

 over recommended operating free-air temperature range, $V_{CCA} = 1.8\text{ V} \pm 0.15\text{ V}$ (unless otherwise noted)

PARAMETER	FROM (INPUT)	TO (OUTPUT)	$V_{CCB} = 1.8\text{ V} \pm 0.15\text{ V}$		$V_{CCB} = 2.5\text{ V} \pm 0.2\text{ V}$		$V_{CCB} = 3.3\text{ V} \pm 0.3\text{ V}$		$V_{CCB} = 5\text{ V} \pm 0.5\text{ V}$		UNIT
			MIN	MAX	MIN	MAX	MIN	MAX	MIN	MAX	
t_{pd}	A	B	1.6	11	1.4	7.7	1.3	6.8	1.2	6.5	ns
	B	A	1.5	12	1.3	8.4	1	7.6	0.9	7.1	
t_{en}	OE	A		1		1		1		1	μs
		B		1		1		1		1	
t_{dis}	OE	A	5.9	31	5.1	21.3	5	19.3	5	17.4	ns
		B	5.4	30.3	4.4	20.8	4.2	17.9	4.3	16.3	
t_{rA} , t_{fA}	A-port rise and fall times		1	4.2	1.1	4.1	1.1	4.1	1.1	4.1	ns
t_{rB} , t_{fB}	B-port rise and fall times		0.9	3.8	0.6	3.2	0.5	2.8	0.4	2.7	ns
$t_{SK(O)}$	Channel-to-channel skew			0.5		0.5		0.5		0.5	ns
Max data rate			60		60		60		60		Mbps

SWITCHING CHARACTERISTICS

over recommended operating free-air temperature range, $V_{CCA} = 2.5 \text{ V} \pm 0.2 \text{ V}$ (unless otherwise noted)

PARAMETER	FROM (INPUT)	TO (OUTPUT)	$V_{CCB} = 2.5 \text{ V} \pm 0.2 \text{ V}$		$V_{CCB} = 3.3 \text{ V} \pm 0.3 \text{ V}$		$V_{CCB} = 5 \text{ V} \pm 0.5 \text{ V}$		UNIT
			MIN	MAX	MIN	MAX	MIN	MAX	
t_{pd}	A	B	1.1	6.3	1	5.2	0.9	4.7	ns
	B	A	1.2	6.6	1.1	5.1	0.9	4.4	
t_{en}	OE	A		1		1		1	μs
		B		1		1		1	
t_{dis}	OE	A	5.1	21.3	4.6	15.2	4.6	13.2	ns
		B	4.4	20.8	3.8	16	3.9	13.9	
t_{rA}, t_{fA}	A-port rise and fall times		0.8	3	0.8	3	0.8	3	ns
t_{rB}, t_{fB}	B-port rise and fall times		0.7	2.6	0.5	2.8	0.4	2.7	ns
$t_{SK(O)}$	Channel-to-channel skew			0.5		0.5		0.5	ns
Max data rate			100		100		100		Mbps

SWITCHING CHARACTERISTICS

over recommended operating free-air temperature range, $V_{CCA} = 3.3 \text{ V} \pm 0.3 \text{ V}$ (unless otherwise noted)

PARAMETER	FROM (INPUT)	TO (OUTPUT)	$V_{CCB} = 3.3 \text{ V} \pm 0.3 \text{ V}$		$V_{CCB} = 5 \text{ V} \pm 0.5 \text{ V}$		UNIT
			MIN	MAX	MIN	MAX	
t_{pd}	A	B	0.9	4.7	0.8	4	ns
	B	A	1	4.9	0.9	3.8	
t_{en}	OE	A		1		1	μs
		B		1		1	
t_{dis}	OE	A	4.6	15.2	4.3	12.1	ns
		B	3.8	16	3.4	13.2	
t_{rA}, t_{fA}	A-port rise and fall times		0.7	2.5	0.7	2.5	ns
t_{rB}, t_{fB}	B-port rise and fall times		0.5	2.1	0.4	2.7	ns
$t_{SK(O)}$	Channel-to-channel skew			0.5		0.5	ns
Max data rate			100		100		Mbps

OPERATING CHARACTERISTICS
 $T_A = 25^\circ\text{C}$

PARAMETER		TEST CONDITIONS	V_{CCA}							UNIT	
			1.2 V	1.2 V	1.5 V	1.8 V	2.5 V	2.5 V	3.3 V		
			V_{CCB}								
			5 V	1.8 V	1.8 V	1.8 V	2.5 V	5 V	3.3 V to 5 V		
			TYP	TYP	TYP	TYP	TYP	TYP	TYP		
C_{pdA}	A-port input, B-port output	$C_L = 0$, $f = 10$ MHz, $t_r = t_f = 1$ ns, $OE = V_{CCA}$ (outputs enabled)	7.8	10	9	8	8	8	9	pF	
	B-port input, A-port output		12	11	11	11	11	11	11		
C_{pdB}	A-port input, B-port output		38.1	28	28	28	29	29	29		
	B-port input, A-port output		25.4	19	18	18	19	21	22		
C_{pdA}	A-port input, B-port output		$C_L = 0$, $f = 10$ MHz, $t_r = t_f = 1$ ns, $OE = \text{GND}$ (outputs disabled)	0.01	0.01	0.01	0.01	0.01	0.01	0.01	pF
	B-port input, A-port output			0.01	0.01	0.01	0.01	0.01	0.01	0.01	
C_{pdB}	A-port input, B-port output			0.01	0.01	0.01	0.01	0.01	0.01	0.03	
	B-port input, A-port output			0.01	0.01	0.01	0.01	0.01	0.01	0.04	

PRINCIPLES OF OPERATION

Applications

The TXB0104 can be used in level-translation applications for interfacing devices or systems operating at different interface voltages with one another.

Architecture

The TXB0104 architecture (see [Figure 1](#)) does not require a direction-control signal to control the direction of data flow from A to B or from B to A. In a dc state, the output drivers of the TXB0104 can maintain a high or low, but are designed to be weak, so that they can be overdriven by an external driver when data on the bus starts flowing the opposite direction.

The output one shots detect rising or falling edges on the A or B ports. During a rising edge, the one shot turns on the PMOS transistors (T1, T3) for a short duration, which speeds up the low-to-high transition. Similarly, during a falling edge, the one shot turns on the NMOS transistors (T2, T4) for a short duration, which speeds up the high-to-low transition. The typical output impedance during output transition is 70 Ω at $V_{CCO} = 1.2\text{ V}$ to 1.8 V, 50 Ω at $V_{CCO} = 1.8\text{ V}$ to 3.3 V, and 40 Ω at $V_{CCO} = 3.3\text{ V}$ to 5 V.

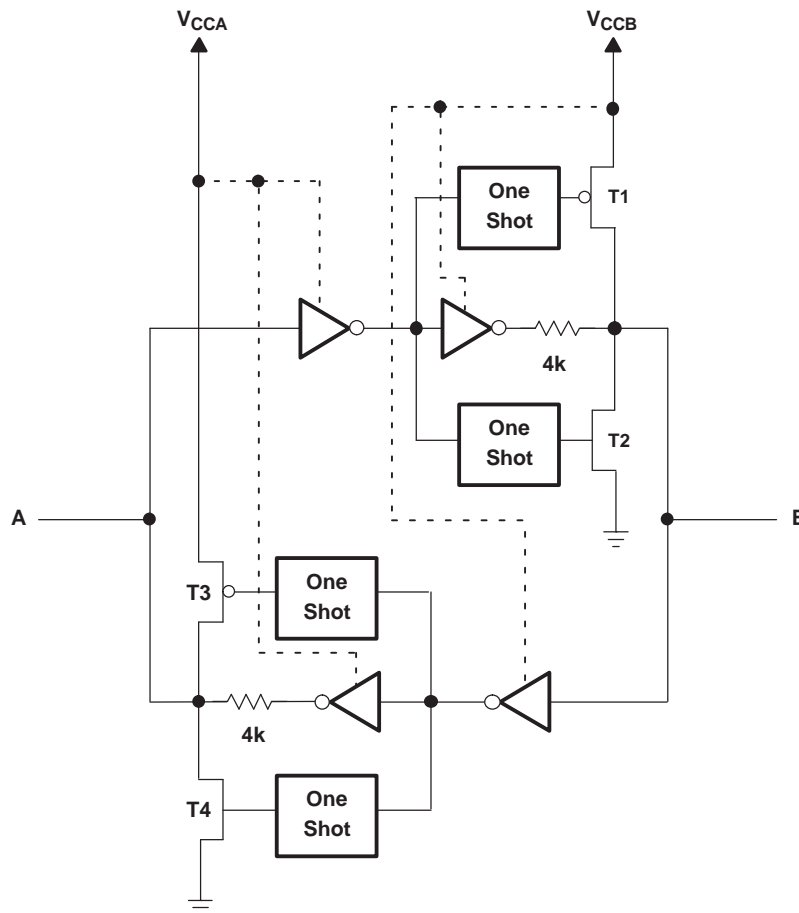
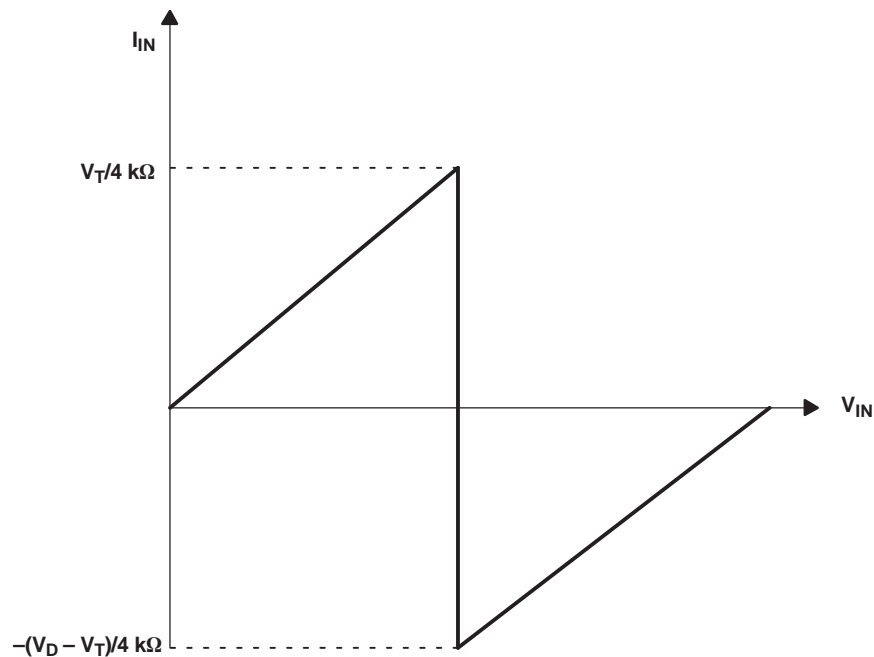

Figure 1. Architecture of TXB0104 I/O Cell

Input Driver Requirements

Typical I_{IN} vs V_{IN} characteristics of the TXB0104 are shown in [Figure 2](#). For proper operation, the device driving the data I/Os of the TXB0104 must have drive strength of at least $\pm 2\text{ mA}$.



- A. V_T is the input threshold voltage of the TXB0104 (typically $V_{CC}/2$).
- B. V_D is the supply voltage of the external driver.

Figure 2. Typical I_{IN} vs V_{IN} Curve

Power Up

During operation, ensure that $V_{CCA} \leq V_{CCB}$ at all times. During power-up sequencing, $V_{CCA} \geq V_{CCB}$ does not damage the device, so any power supply can be ramped up first. The TXB0104 has circuitry that disables all output ports when either V_{CC} is switched off ($V_{CCA/B} = 0 \text{ V}$).

Enable and Disable

The TXB0104 has an OE input that is used to disable the device by setting OE = low, which places all I/Os in the high-impedance (Hi-Z) state. The disable time (t_{dis}) indicates the delay between when OE goes low and when the outputs actually get disabled (Hi-Z). The enable time (t_{en}) indicates the amount of time the user must allow for the one-shot circuitry to become operational after OE is taken high.

Pullup or Pulldown Resistors on I/O Lines

The TXB0104 is designed to drive capacitive loads of up to 70 pF. The output drivers of the TXB0104 have low dc drive strength. If pullup or pulldown resistors are connected externally to the data I/Os, their values must be kept higher than 50 k Ω to ensure that they do not contend with the output drivers of the TXB0104.

For the same reason, the TXB0104 should not be used in applications such as I²C or 1-Wire where an open-drain driver is connected on the bidirectional data I/O. For these applications, use a device from the TI TXS01xx series of level translators.

PARAMETER MEASUREMENT INFORMATION

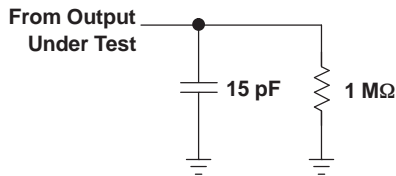

LOAD CIRCUIT FOR MAX DATA RATE, PULSE DURATION PROPAGATION DELAY OUTPUT RISE AND FALL TIME MEASUREMENT

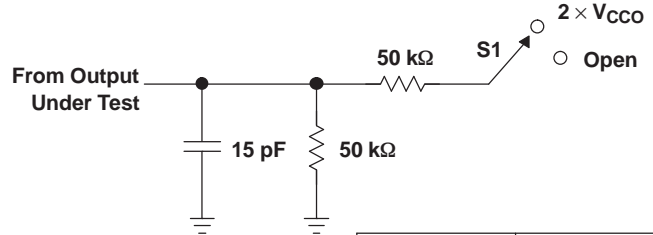

LOAD CIRCUIT FOR ENABLE/DISABLE TIME MEASUREMENT

TEST	S1
t_{PZL}/t_{PLZ}	$2 \times V_{CCO}$
t_{PHZ}/t_{PZH}	Open

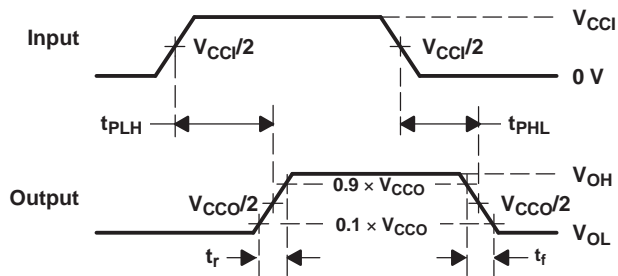

VOLTAGE WAVEFORMS PROPAGATION DELAY TIMES

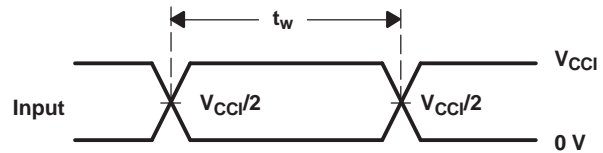

VOLTAGE WAVEFORMS PULSE DURATION

- A. C_L includes probe and jig capacitance.
- B. All input pulses are supplied by generators having the following characteristics: $PRR \leq 10$ MHz, $Z_O = 50 \Omega$, $dv/dt \geq 1$ V/ns.
- C. The outputs are measured one at a time, with one transition per measurement.
- D. t_{PLH} and t_{PHL} are the same as t_{pd} .
- E. V_{CCI} is the V_{CC} associated with the input port.
- F. V_{CCO} is the V_{CC} associated with the output port.
- G. All parameters and waveforms are not applicable to all devices.

Figure 3. Load Circuits and Voltage Waveforms

PACKAGING INFORMATION

Orderable Device	Status ⁽¹⁾	Package Type	Package Drawing	Pins	Package Qty	Eco Plan ⁽²⁾	Lead/ Ball Finish	MSL Peak Temp ⁽³⁾	Samples (Requires Login)
TXB0104D	ACTIVE	SOIC	D	14	50	Green (RoHS & no Sb/Br)	CU NIPDAU	Level-1-260C-UNLIM	Contact TI Distributor or Sales Office
TXB0104DG4	ACTIVE	SOIC	D	14	50	Green (RoHS & no Sb/Br)	CU NIPDAU	Level-1-260C-UNLIM	Contact TI Distributor or Sales Office
TXB0104DR	ACTIVE	SOIC	D	14	2500	Green (RoHS & no Sb/Br)	CU NIPDAU	Level-1-260C-UNLIM	Request Free Samples
TXB0104DRG4	ACTIVE	SOIC	D	14	2500	Green (RoHS & no Sb/Br)	CU NIPDAU	Level-1-260C-UNLIM	Request Free Samples
TXB0104GXUR	ACTIVE	BGA MICROSTAR JUNIOR	GXU	12	2500	TBD	SNPB	Level-1-240C-UNLIM	Contact TI Distributor or Sales Office
TXB0104PWR	ACTIVE	TSSOP	PW	14	2000	Green (RoHS & no Sb/Br)	CU NIPDAU	Level-1-260C-UNLIM	Request Free Samples
TXB0104PWRG4	ACTIVE	TSSOP	PW	14	2000	Green (RoHS & no Sb/Br)	CU NIPDAU	Level-1-260C-UNLIM	Request Free Samples
TXB0104RGYR	ACTIVE	VQFN	RGY	14	3000	Green (RoHS & no Sb/Br)	CU NIPDAU	Level-2-260C-1 YEAR	Request Free Samples
TXB0104RGYRG4	ACTIVE	VQFN	RGY	14	3000	Green (RoHS & no Sb/Br)	CU NIPDAU	Level-2-260C-1 YEAR	Request Free Samples
TXB0104RUTR	ACTIVE	UQFN	RUT	12	3000	Green (RoHS & no Sb/Br)	CU NIPDAU	Level-1-260C-UNLIM	Request Free Samples
TXB0104YZTR	ACTIVE	DSBGA	YZT	12	3000	Green (RoHS & no Sb/Br)	SNAGCU	Level-1-260C-UNLIM	Request Free Samples
TXB0104ZXUR	ACTIVE	BGA MICROSTAR JUNIOR	ZXU	12	2500	Green (RoHS & no Sb/Br)	SNAGCU	Level-1-260C-UNLIM	Request Free Samples

⁽¹⁾ The marketing status values are defined as follows:

ACTIVE: Product device recommended for new designs.

LIFEBUY: TI has announced that the device will be discontinued, and a lifetime-buy period is in effect.

NRND: Not recommended for new designs. Device is in production to support existing customers, but TI does not recommend using this part in a new design.

PREVIEW: Device has been announced but is not in production. Samples may or may not be available.

OBSELETE: TI has discontinued the production of the device.

⁽²⁾ Eco Plan - The planned eco-friendly classification: Pb-Free (RoHS), Pb-Free (RoHS Exempt), or Green (RoHS & no Sb/Br) - please check <http://www.ti.com/productcontent> for the latest availability information and additional product content details.

TBD: The Pb-Free/Green conversion plan has not been defined.

Pb-Free (RoHS): TI's terms "Lead-Free" or "Pb-Free" mean semiconductor products that are compatible with the current RoHS requirements for all 6 substances, including the requirement that lead not exceed 0.1% by weight in homogeneous materials. Where designed to be soldered at high temperatures, TI Pb-Free products are suitable for use in specified lead-free processes.

Pb-Free (RoHS Exempt): This component has a RoHS exemption for either 1) lead-based flip-chip solder bumps used between the die and package, or 2) lead-based die adhesive used between the die and leadframe. The component is otherwise considered Pb-Free (RoHS compatible) as defined above.

Green (RoHS & no Sb/Br): TI defines "Green" to mean Pb-Free (RoHS compatible), and free of Bromine (Br) and Antimony (Sb) based flame retardants (Br or Sb do not exceed 0.1% by weight in homogeneous material)

⁽³⁾ MSL, Peak Temp. -- The Moisture Sensitivity Level rating according to the JEDEC industry standard classifications, and peak solder temperature.

Important Information and Disclaimer: The information provided on this page represents TI's knowledge and belief as of the date that it is provided. TI bases its knowledge and belief on information provided by third parties, and makes no representation or warranty as to the accuracy of such information. Efforts are underway to better integrate information from third parties. TI has taken and continues to take reasonable steps to provide representative and accurate information but may not have conducted destructive testing or chemical analysis on incoming materials and chemicals. TI and TI suppliers consider certain information to be proprietary, and thus CAS numbers and other limited information may not be available for release.

In no event shall TI's liability arising out of such information exceed the total purchase price of the TI part(s) at issue in this document sold by TI to Customer on an annual basis.

OTHER QUALIFIED VERSIONS OF TXB0104 :

- Automotive: [TXB0104-Q1](#)

NOTE: Qualified Version Definitions:

- Automotive - Q100 devices qualified for high-reliability automotive applications targeting zero defects

TAPE AND REEL INFORMATION



QUADRANT ASSIGNMENTS FOR PIN 1 ORIENTATION IN TAPE

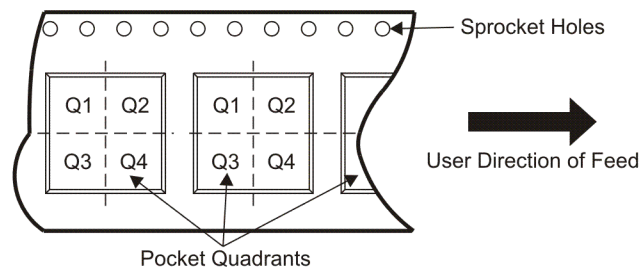

*All dimensions are nominal

Device	Package Type	Package Drawing	Pins	SPQ	Reel Diameter (mm)	Reel Width W1 (mm)	A0 (mm)	B0 (mm)	K0 (mm)	P1 (mm)	W (mm)	Pin1 Quadrant
TXB0104DR	SOIC	D	14	2500	330.0	16.4	6.5	9.0	2.1	8.0	16.0	Q1
TXB0104GXUR	BGA MICROSTAR JUNIOR	GXU	12	2500	330.0	8.4	2.3	2.8	1.0	4.0	8.0	Q2
TXB0104PWR	TSSOP	PW	14	2000	330.0	12.4	6.9	5.6	1.6	8.0	12.0	Q1
TXB0104RGYR	VQFN	RGY	14	3000	330.0	12.4	3.75	3.75	1.15	8.0	12.0	Q1
TXB0104RUTR	UQFN	RUT	12	3000	180.0	8.4	1.95	2.3	0.75	4.0	8.0	Q1
TXB0104YZTR	DSBGA	YZT	12	3000	180.0	8.4	1.49	1.99	0.75	4.0	8.0	Q2
TXB0104ZXUR	BGA MICROSTAR JUNIOR	ZXU	12	2500	330.0	8.4	2.3	2.8	1.0	4.0	8.0	Q2

TAPE AND REEL BOX DIMENSIONS

*All dimensions are nominal

Device	Package Type	Package Drawing	Pins	SPQ	Length (mm)	Width (mm)	Height (mm)
TXB0104DR	SOIC	D	14	2500	346.0	346.0	33.0
TXB0104GXUR	BGA MICROSTAR JUNIOR	GXU	12	2500	340.5	338.1	20.6
TXB0104PWR	TSSOP	PW	14	2000	346.0	346.0	29.0
TXB0104RGYR	VQFN	RGY	14	3000	346.0	346.0	29.0
TXB0104RUTR	UQFN	RUT	12	3000	202.0	201.0	28.0
TXB0104YZTR	DSBGA	YZT	12	3000	190.5	212.7	31.8
TXB0104ZXUR	BGA MICROSTAR JUNIOR	ZXU	12	2500	340.5	338.1	20.6

GXU (S-PBGA-N12)

PLASTIC BALL GRID ARRAY

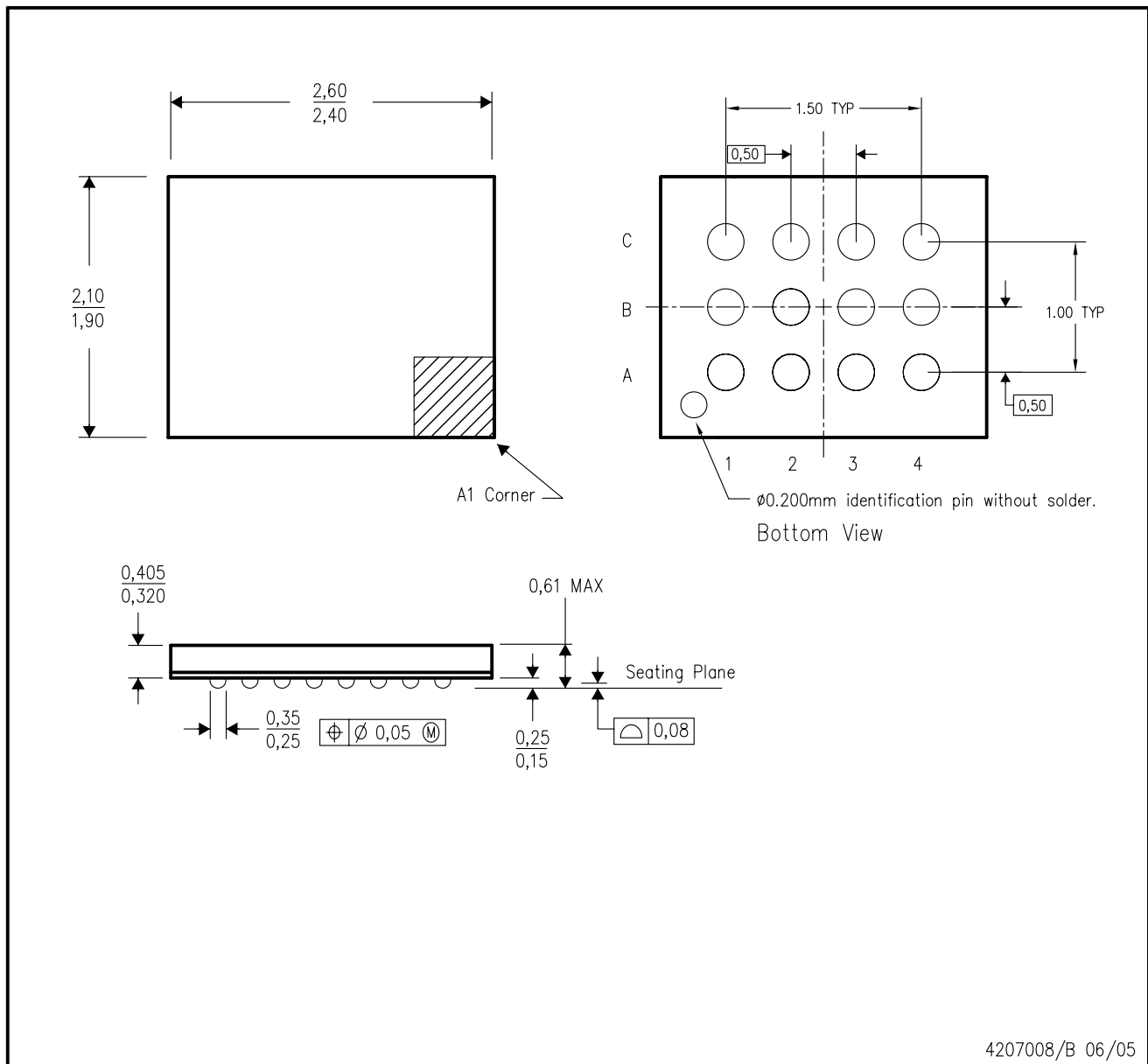

- NOTES:
- A. All linear dimensions are in millimeters.
 - B. This drawing is subject to change without notice.

ZXU (S-PBGA-N12)

PLASTIC BALL GRID ARRAY

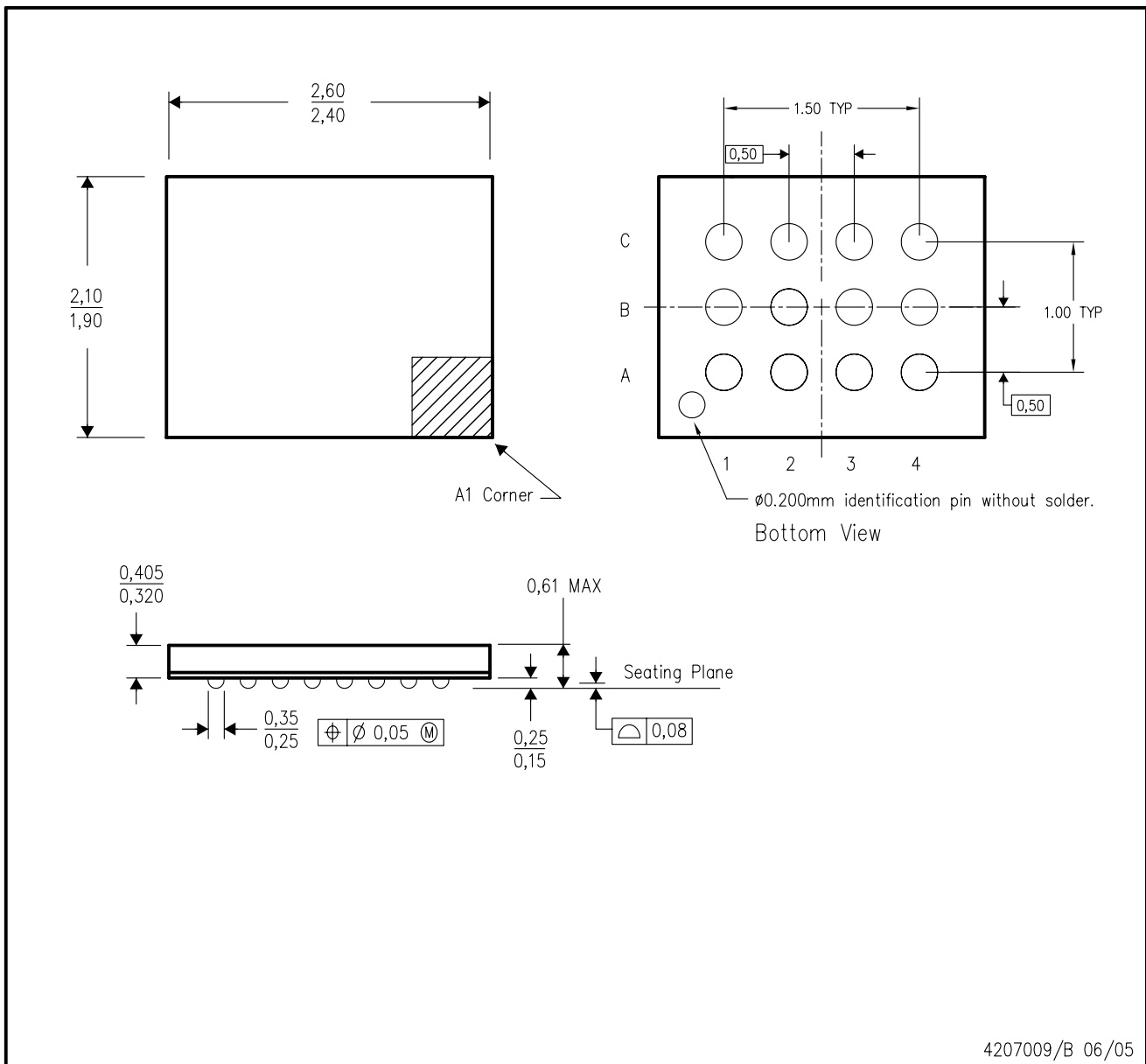

- NOTES:
- A. All linear dimensions are in millimeters.
 - B. This drawing is subject to change without notice.
 - C. This package is a lead-free solder ball design.

D (R-PDSO-G14)

PLASTIC SMALL OUTLINE



- NOTES:
- A. All linear dimensions are in inches (millimeters).
 - B. This drawing is subject to change without notice.
 -  Body length does not include mold flash, protrusions, or gate burrs. Mold flash, protrusions, or gate burrs shall not exceed 0.006 (0,15) each side.
 -  Body width does not include interlead flash. Interlead flash shall not exceed 0.017 (0,43) each side.
 - E. Reference JEDEC MS-012 variation AB.

D (R-PDSO-G14)

PLASTIC SMALL OUTLINE

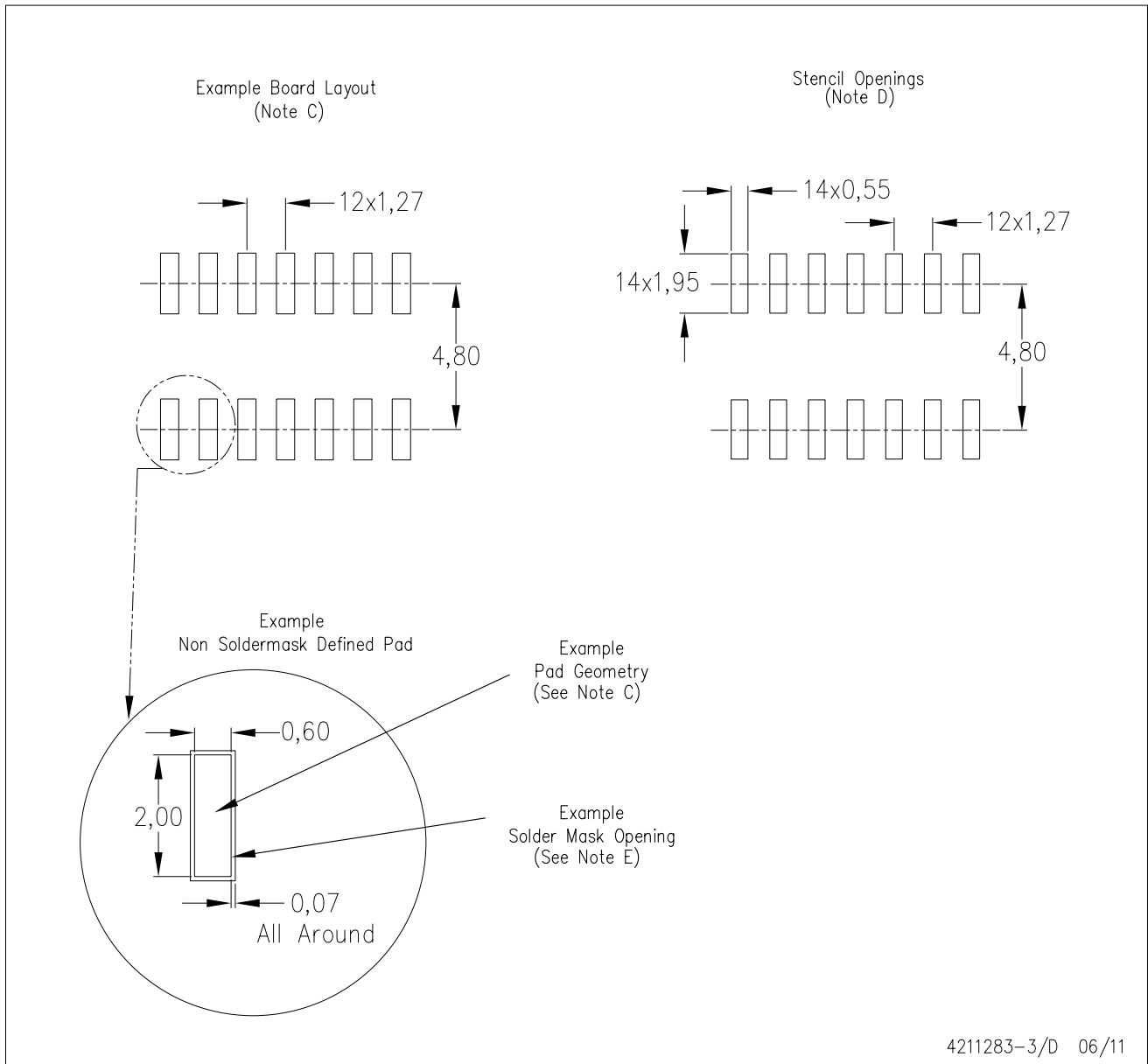

- NOTES:
- A. All linear dimensions are in millimeters.
 - B. This drawing is subject to change without notice.
 - C. Publication IPC-7351 is recommended for alternate designs.
 - D. Laser cutting apertures with trapezoidal walls and also rounding corners will offer better paste release. Customers should contact their board assembly site for stencil design recommendations. Refer to IPC-7525 for other stencil recommendations.
 - E. Customers should contact their board fabrication site for solder mask tolerances between and around signal pads.

PW (R-PDSO-G14)

PLASTIC SMALL OUTLINE

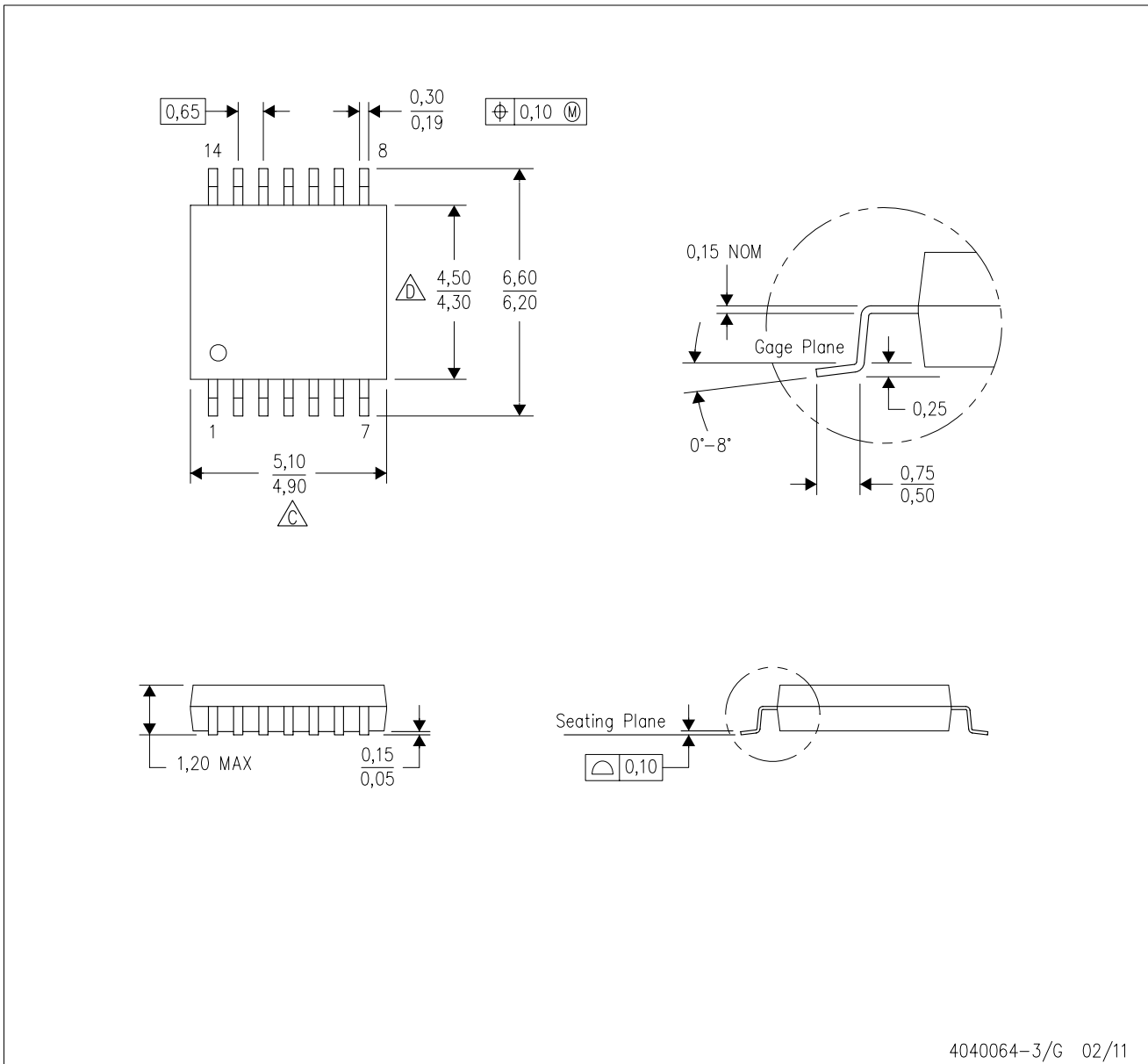

- NOTES:
- A. All linear dimensions are in millimeters. Dimensioning and tolerancing per ASME Y14.5M-1994.
 - B. This drawing is subject to change without notice.
 -  Body length does not include mold flash, protrusions, or gate burrs. Mold flash, protrusions, or gate burrs shall not exceed 0,15 each side.
 -  Body width does not include interlead flash. Interlead flash shall not exceed 0,25 each side.
 - E. Falls within JEDEC MO-153

PW (R-PDSO-G14)

PLASTIC SMALL OUTLINE

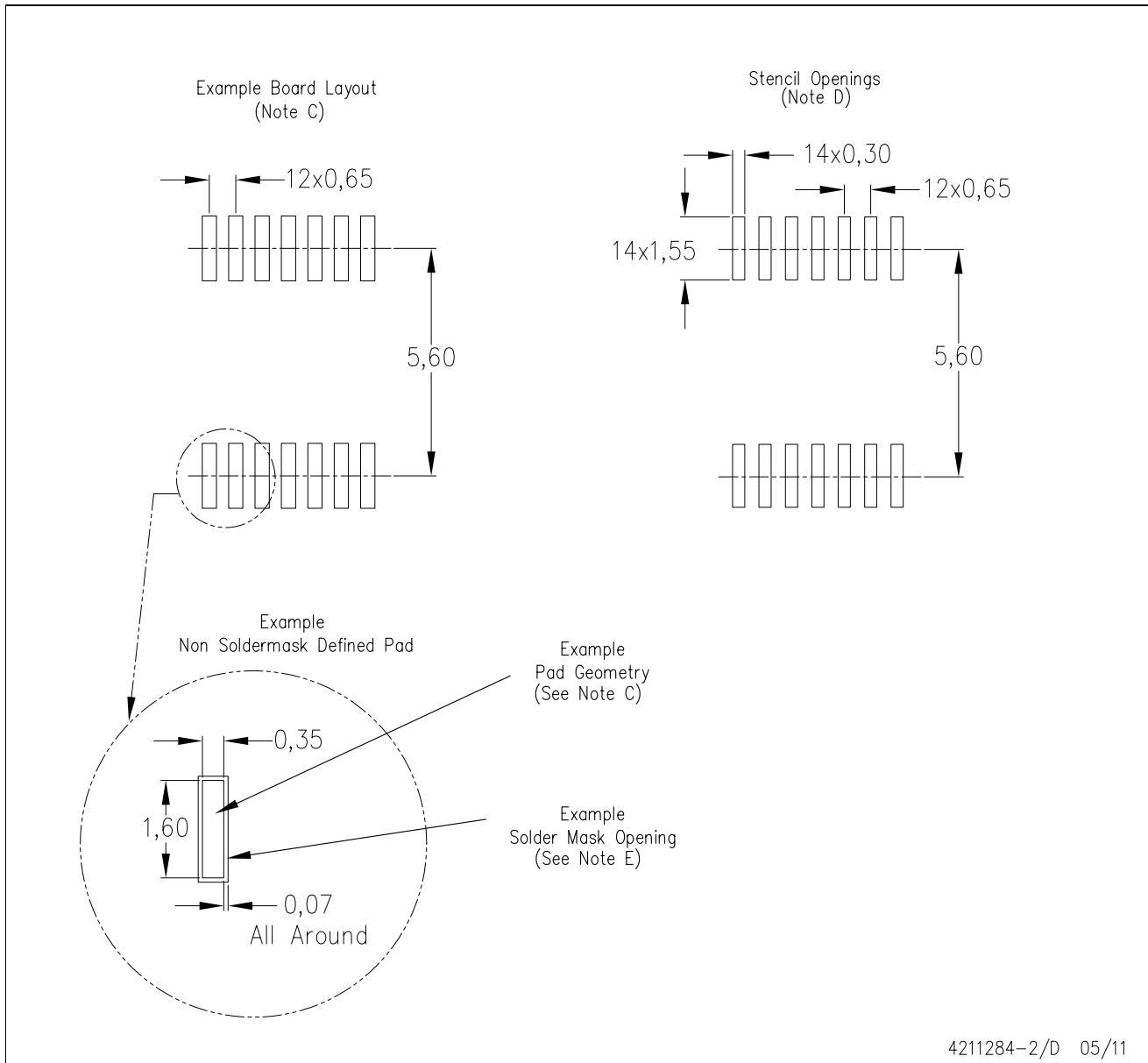

- NOTES:
- All linear dimensions are in millimeters.
 - This drawing is subject to change without notice.
 - Publication IPC-7351 is recommended for alternate designs.
 - Laser cutting apertures with trapezoidal walls and also rounding corners will offer better paste release. Customers should contact their board assembly site for stencil design recommendations. Refer to IPC-7525 for other stencil recommendations.
 - Customers should contact their board fabrication site for solder mask tolerances between and around signal pads.

RGY (S-PVQFN-N14)

PLASTIC QUAD FLATPACK NO-LEAD

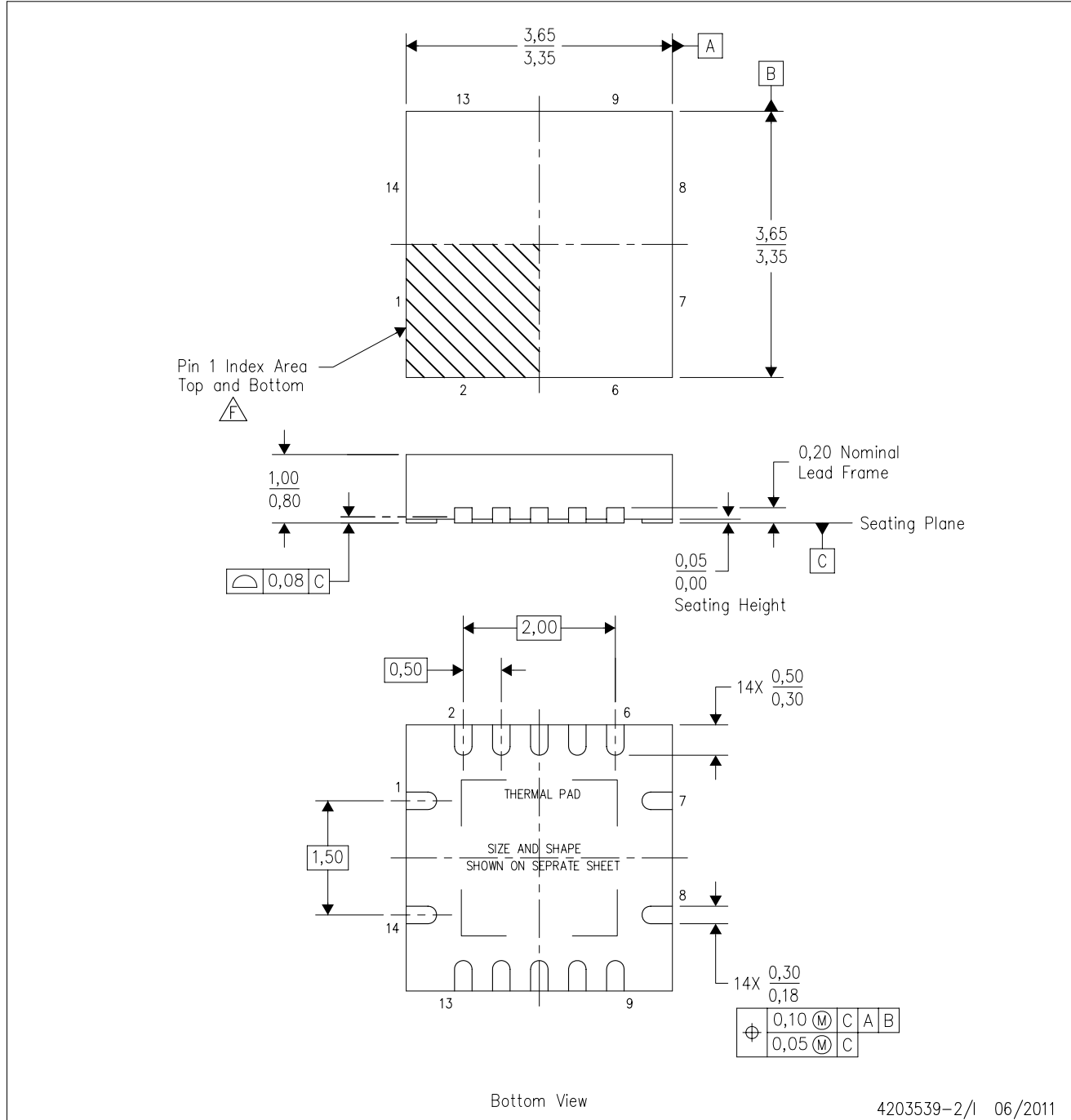

4203539-2/1 06/2011

- NOTES:
- All linear dimensions are in millimeters. Dimensioning and tolerancing per ASME Y14.5M-1994.
 - This drawing is subject to change without notice.
 - QFN (Quad Flatpack No-Lead) package configuration.
 - The package thermal pad must be soldered to the board for thermal and mechanical performance.
 - See the additional figure in the Product Data Sheet for details regarding the exposed thermal pad features and dimensions.
 - △ Pin 1 identifiers are located on both top and bottom of the package and within the zone indicated. The Pin 1 identifiers are either a molded, marked, or metal feature.
 - Package complies to JEDEC MO-241 variation BA.

RGY (S-PVQFN-N14)

PLASTIC QUAD FLATPACK NO-LEAD

THERMAL INFORMATION

This package incorporates an exposed thermal pad that is designed to be attached directly to an external heatsink. The thermal pad must be soldered directly to the printed circuit board (PCB). After soldering, the PCB can be used as a heatsink. In addition, through the use of thermal vias, the thermal pad can be attached directly to the appropriate copper plane shown in the electrical schematic for the device, or alternatively, can be attached to a special heatsink structure designed into the PCB. This design optimizes the heat transfer from the integrated circuit (IC).

For information on the Quad Flatpack No-Lead (QFN) package and its advantages, refer to Application Report, QFN/SON PCB Attachment, Texas Instruments Literature No. SLUA271. This document is available at www.ti.com.

The exposed thermal pad dimensions for this package are shown in the following illustration.

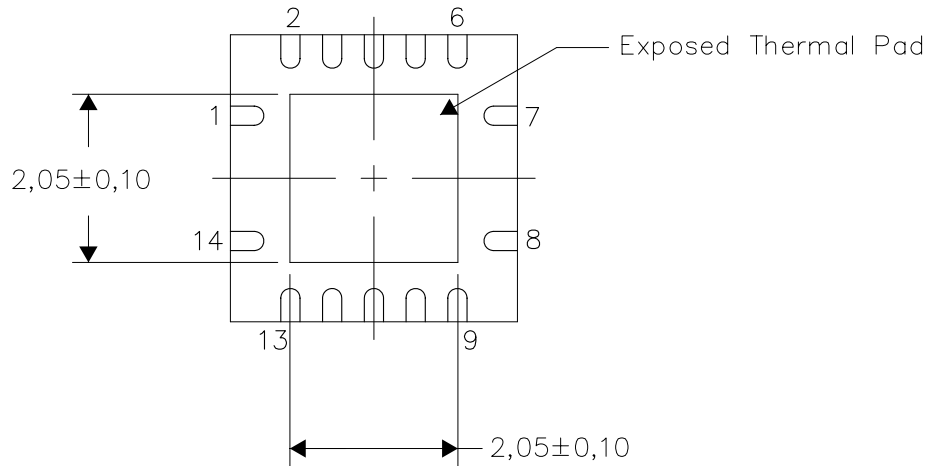

Bottom View

Exposed Thermal Pad Dimensions

4206353-2/N 06/11

NOTE: A. All linear dimensions are in millimeters

RGY (S-PVQFN-N14)

PLASTIC QUAD FLATPACK NO-LEAD

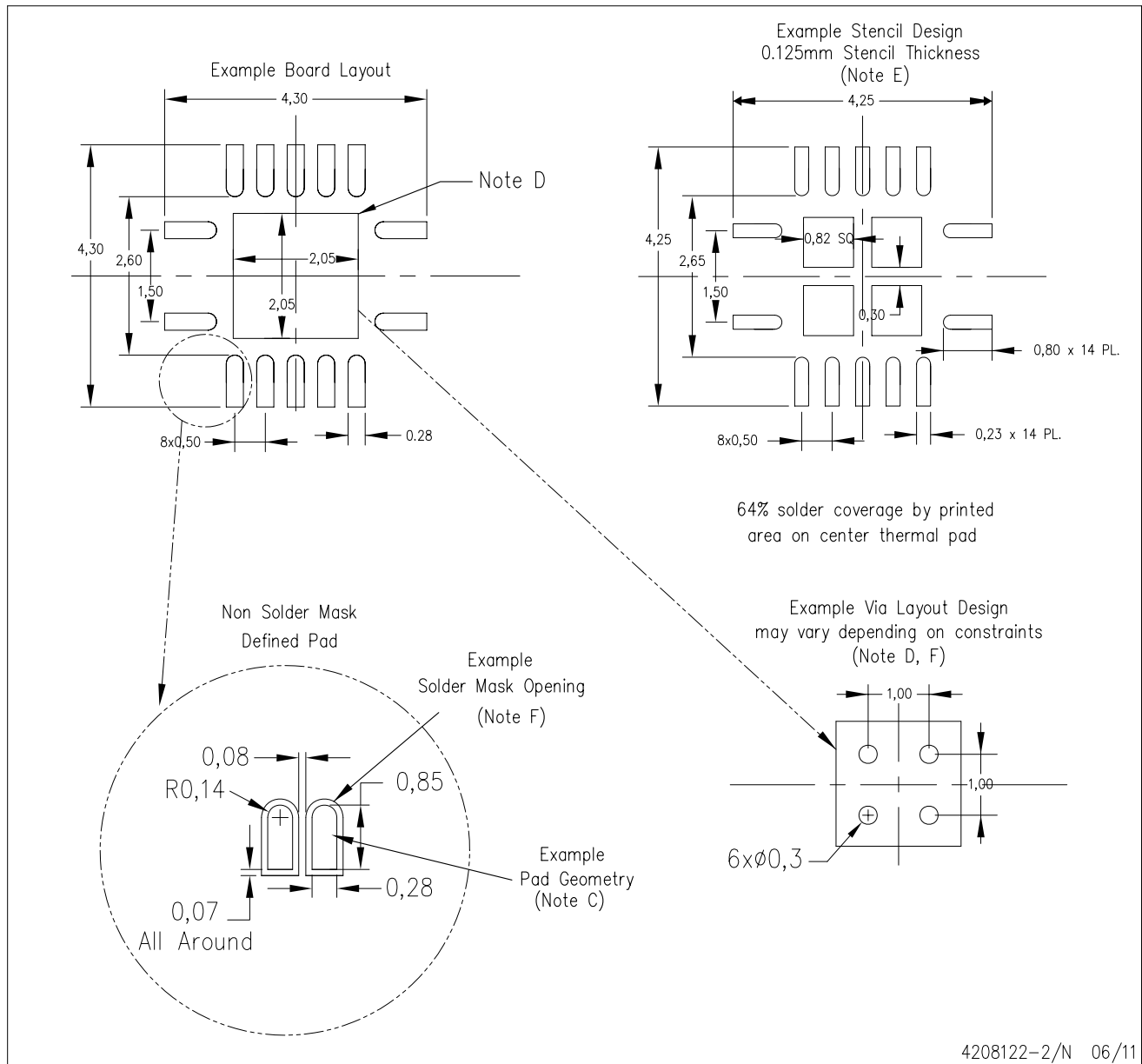

- NOTES:
- All linear dimensions are in millimeters.
 - This drawing is subject to change without notice.
 - Publication IPC-7351 is recommended for alternate designs.
 - This package is designed to be soldered to a thermal pad on the board. Refer to Application Note, Quad Flat-Pack QFN/SON PCB Attachment, Texas Instruments Literature No. SLUA271, and also the Product Data Sheets for specific thermal information, via requirements, and recommended board layout. These documents are available at www.ti.com <<http://www.ti.com>>.
 - Laser cutting apertures with trapezoidal walls and also rounding corners will offer better paste release. Customers should contact their board assembly site for stencil design recommendations. Refer to IPC 7525 for stencil design considerations.
 - Customers should contact their board fabrication site for minimum solder mask web tolerances between signal pads.

RUT (R-PUQFN-N12)

PLASTIC QUAD FLATPACK NO-LEAD

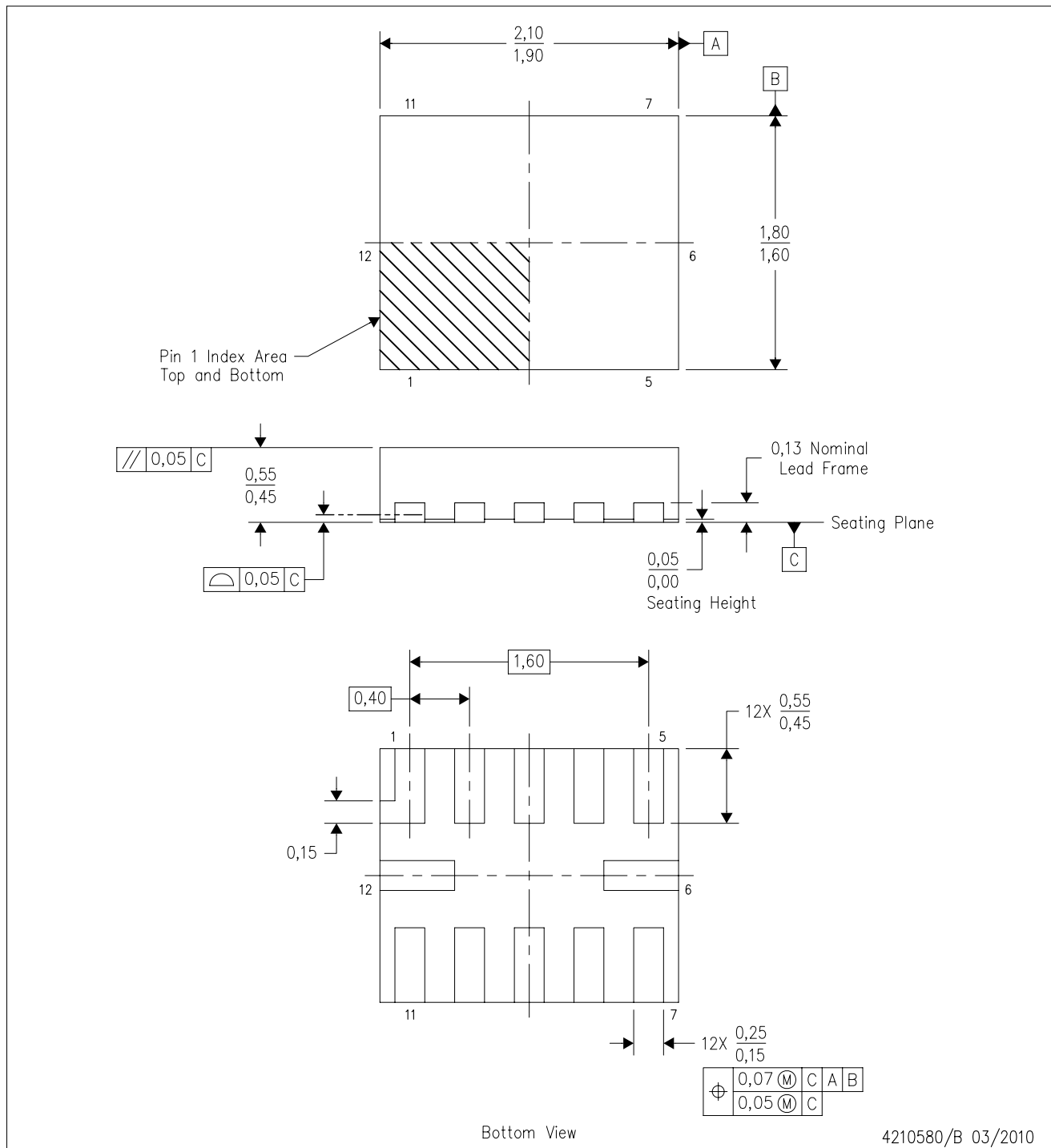

- NOTES:
- All linear dimensions are in millimeters. Dimensioning and tolerancing per ASME Y14.5M-1994.
 - This drawing is subject to change without notice.
 - QFN (Quad Flatpack No-Lead) package configuration.

YZT (R-XBGA-N12)

(CUSTOM) DIE-SIZE BALL GRID ARRAY

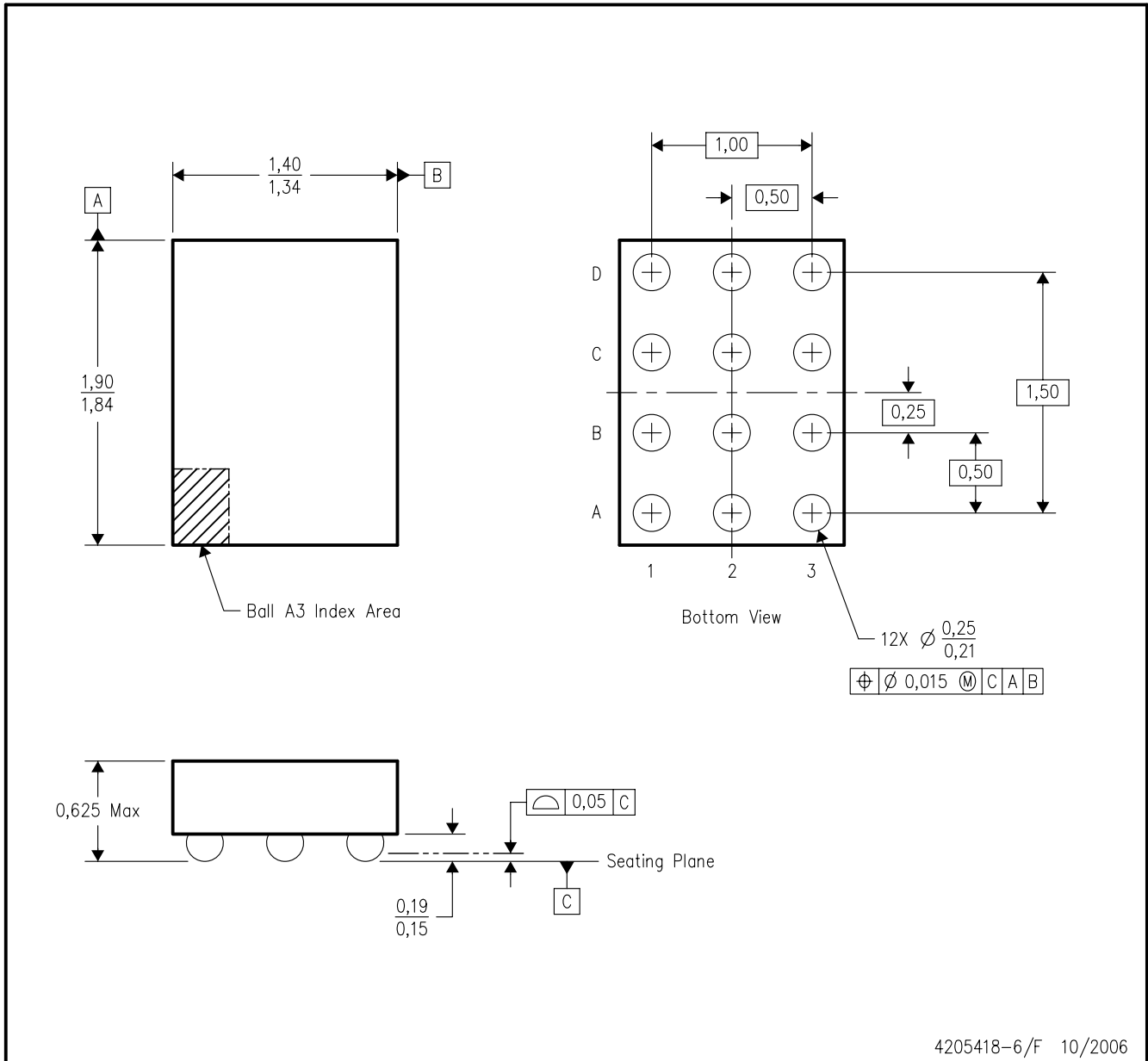

- NOTES:
- A. All linear dimensions are in millimeters. Dimensioning and tolerancing per ASME Y14.5M-1994.
 - B. This drawing is subject to change without notice.
 - C. NanoFree™ package configuration.
 - D. This is a lead-free solder ball design.

NanoFree is a trademark of Texas Instruments.

IMPORTANT NOTICE

Texas Instruments Incorporated and its subsidiaries (TI) reserve the right to make corrections, modifications, enhancements, improvements, and other changes to its products and services at any time and to discontinue any product or service without notice. Customers should obtain the latest relevant information before placing orders and should verify that such information is current and complete. All products are sold subject to TI's terms and conditions of sale supplied at the time of order acknowledgment.

TI warrants performance of its hardware products to the specifications applicable at the time of sale in accordance with TI's standard warranty. Testing and other quality control techniques are used to the extent TI deems necessary to support this warranty. Except where mandated by government requirements, testing of all parameters of each product is not necessarily performed.

TI assumes no liability for applications assistance or customer product design. Customers are responsible for their products and applications using TI components. To minimize the risks associated with customer products and applications, customers should provide adequate design and operating safeguards.

TI does not warrant or represent that any license, either express or implied, is granted under any TI patent right, copyright, mask work right, or other TI intellectual property right relating to any combination, machine, or process in which TI products or services are used. Information published by TI regarding third-party products or services does not constitute a license from TI to use such products or services or a warranty or endorsement thereof. Use of such information may require a license from a third party under the patents or other intellectual property of the third party, or a license from TI under the patents or other intellectual property of TI.

Reproduction of TI information in TI data books or data sheets is permissible only if reproduction is without alteration and is accompanied by all associated warranties, conditions, limitations, and notices. Reproduction of this information with alteration is an unfair and deceptive business practice. TI is not responsible or liable for such altered documentation. Information of third parties may be subject to additional restrictions.

Resale of TI products or services with statements different from or beyond the parameters stated by TI for that product or service voids all express and any implied warranties for the associated TI product or service and is an unfair and deceptive business practice. TI is not responsible or liable for any such statements.

TI products are not authorized for use in safety-critical applications (such as life support) where a failure of the TI product would reasonably be expected to cause severe personal injury or death, unless officers of the parties have executed an agreement specifically governing such use. Buyers represent that they have all necessary expertise in the safety and regulatory ramifications of their applications, and acknowledge and agree that they are solely responsible for all legal, regulatory and safety-related requirements concerning their products and any use of TI products in such safety-critical applications, notwithstanding any applications-related information or support that may be provided by TI. Further, Buyers must fully indemnify TI and its representatives against any damages arising out of the use of TI products in such safety-critical applications.

TI products are neither designed nor intended for use in military/aerospace applications or environments unless the TI products are specifically designated by TI as military-grade or "enhanced plastic." Only products designated by TI as military-grade meet military specifications. Buyers acknowledge and agree that any such use of TI products which TI has not designated as military-grade is solely at the Buyer's risk, and that they are solely responsible for compliance with all legal and regulatory requirements in connection with such use.

TI products are neither designed nor intended for use in automotive applications or environments unless the specific TI products are designated by TI as compliant with ISO/TS 16949 requirements. Buyers acknowledge and agree that, if they use any non-designated products in automotive applications, TI will not be responsible for any failure to meet such requirements.

Following are URLs where you can obtain information on other Texas Instruments products and application solutions:

Products

Audio	www.ti.com/audio
Amplifiers	amplifier.ti.com
Data Converters	dataconverter.ti.com
DLP® Products	www.dlp.com
DSP	dsp.ti.com
Clocks and Timers	www.ti.com/clocks
Interface	interface.ti.com
Logic	logic.ti.com
Power Mgmt	power.ti.com
Microcontrollers	microcontroller.ti.com
RFID	www.ti-rfid.com
RF/IF and ZigBee® Solutions	www.ti.com/lprf

Applications

Communications and Telecom	www.ti.com/communications
Computers and Peripherals	www.ti.com/computers
Consumer Electronics	www.ti.com/consumer-apps
Energy and Lighting	www.ti.com/energy
Industrial	www.ti.com/industrial
Medical	www.ti.com/medical
Security	www.ti.com/security
Space, Avionics and Defense	www.ti.com/space-avionics-defense
Transportation and Automotive	www.ti.com/automotive
Video and Imaging	www.ti.com/video
Wireless	www.ti.com/wireless-apps

TI E2E Community Home Page

e2e.ti.com

Mailing Address: Texas Instruments, Post Office Box 655303, Dallas, Texas 75265
Copyright © 2011, Texas Instruments Incorporated