

AVX, the world's leading manufacturer of Tantalum capacitors, has now released the world first Niobium Oxide Capacitors. AVX Niobium Oxide Capacitors are drawing worldwide attention because of their non-burn technology and availability and stability of raw materials supply. AVX is committed to total customer satisfaction by delivering products of the highest quality, providing strong technical support, and at competitive prices. With one of the fullest lineups in the capacitor business, AVX can satisfy a broad range of customer needs in a myriad of applications.

Tantalum Series Guide

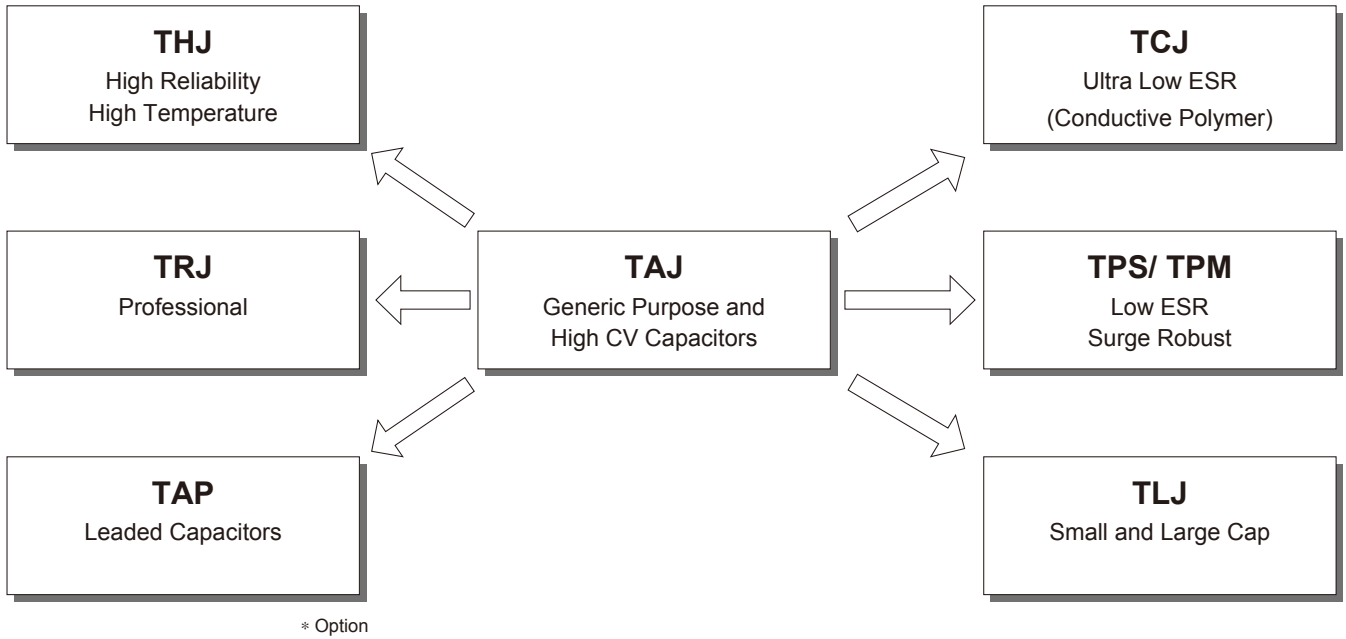

Niobium Oxide Series Guide

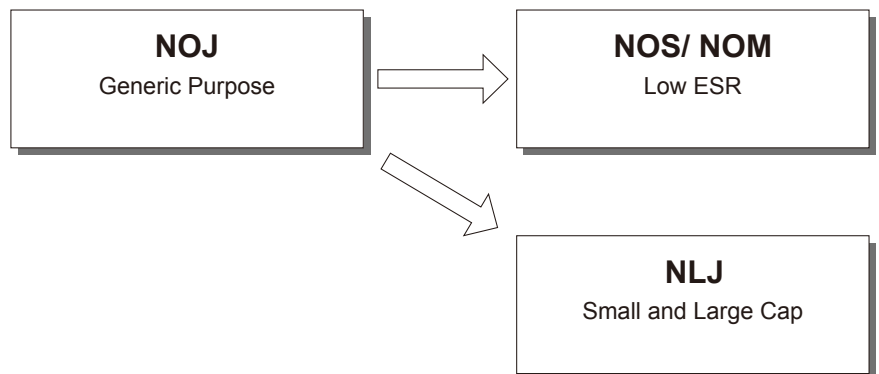

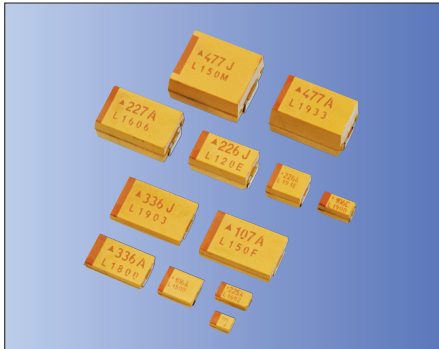

Pb Free

RoHS Compliant

Features

- 50V type is available
- 2200 μ F/ 2.5V (V case) is available
- 25m Ω ESR type is available
 50 for TPS series

Applications

- Electronic Equipment in General
- CPU's
- Power Supply Circuit

How to Order

TAJ B 107 M 010 Y
 ① ② ③ ④ ⑤ ⑥

TPS B 107 M 010 Y 0400
 ① ② ③ ④ ⑤ ⑥ ⑦

TPM E 108 M 004 R 0018
 ① ② ③ ④ ⑤ ⑥ ⑦

- ① Series
- ② Case Size (See Table)
- ③ Capacitance (pF)
 (Code: 2 Significant Digits and Number of Zeros)
- ④ Tolerance

K*	$\pm 10\%$	M	$\pm 20\%$
-----------	------------	----------	------------

*Optional

- ⑤ Rated DC Voltage

ex.	006	6.3VDC
002	2.5VDC	016 16VDC

- ⑥ Packaging

TAJ/ TPS Series

Y	Plastic Tape (7" Reel)
----------	------------------------

TPM Series

R	Plastic Tape (7" Reel)
----------	------------------------

- ⑦ ESR

ex.	0100	100m Ω
------------	-------------	---------------

Case Dimensions

(Unit: mm)

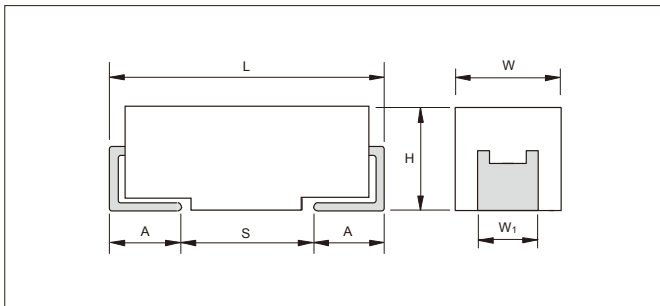

Case size	L	W	H	W ₁	A	S min.
A	3.2 ± 0.2	1.6 $^{+0.2}_{-0.1}$	1.6 $^{+0.2}_{-0.1}$	1.2 ± 0.2	0.8 $^{+0.3}_{-0.2}$	1.1
B	3.5 ± 0.2	2.8 $^{+0.2}_{-0.1}$	1.9 $^{+0.2}_{-0.1}$	2.2 ± 0.2	0.8 $^{+0.3}_{-0.2}$	1.4
C	6.0 ± 0.2	3.2 $^{+0.2}_{-0.1}$	2.6 $^{+0.2}_{-0.1}$	2.2 ± 0.2	1.3 $^{+0.3}_{-0.2}$	2.9
D	7.3 ± 0.2	4.3 $^{+0.2}_{-0.1}$	2.9 $^{+0.2}_{-0.1}$	2.4 ± 0.2	1.3 $^{+0.3}_{-0.2}$	4.4
E	7.3 ± 0.2	4.3 $^{+0.2}_{-0.1}$	4.1 $^{+0.2}_{-0.1}$	2.4 ± 0.2	1.3 $^{+0.3}_{-0.2}$	4.4
V	7.3 ± 0.2	6.1 $^{+0.2}_{-0.1}$	3.45 ± 0.3	3.1 ± 0.2	1.4 $^{+0.3}_{-0.2}$	4.4
F	6.0 ± 0.2	3.2 $^{+0.2}_{-0.1}$	2.0 max.	2.2 ± 0.2	1.3 $^{+0.3}_{-0.2}$	2.9
K	3.2 ± 0.2	1.6 $^{+0.2}_{-0.1}$	1.0 max.	1.2 ± 0.2	0.8 $^{+0.3}_{-0.2}$	1.1
P	2.05 ± 0.2	1.35 $^{+0.2}_{-0.1}$	1.5 max.	1.0 ± 0.2	0.5 $^{+0.3}_{-0.2}$	0.85
R	2.05 ± 0.2	1.3 $^{+0.2}_{-0.1}$	1.2 max.	1.0 ± 0.2	0.5 $^{+0.3}_{-0.2}$	0.85
S	3.2 ± 0.2	1.6 $^{+0.2}_{-0.1}$	1.2 max.	1.2 ± 0.2	0.8 $^{+0.3}_{-0.2}$	1.1
T	3.5 ± 0.2	2.8 $^{+0.2}_{-0.1}$	1.2 max.	2.2 ± 0.2	0.8 $^{+0.3}_{-0.2}$	1.4
W	6.0 ± 0.2	3.2 $^{+0.2}_{-0.1}$	1.5 max.	2.2 ± 0.2	1.3 $^{+0.3}_{-0.2}$	2.9
X	7.3 ± 0.2	4.3 $^{+0.2}_{-0.1}$	1.5 max.	2.4 ± 0.2	1.3 $^{+0.3}_{-0.2}$	4.4
Y	7.3 ± 0.2	4.3 $^{+0.2}_{-0.1}$	2.0 max.	2.4 ± 0.2	1.3 $^{+0.3}_{-0.2}$	4.4

Specifications

Rated Voltage (V_R) $\leq +85^{\circ}\text{C}$	2.5	4	6.3	10	16	20	25	35	50	
Category Voltage (V_C) $\leq +125^{\circ}\text{C}$	1.7	2.7	4	7	10	13	17	23	33	
Surge Voltage (V_S)	$\leq +85^{\circ}\text{C}$	3.3	5.2	8	13	20	26	32	46	65
	$\leq +125^{\circ}\text{C}$	2.2	3.4	5	8	13	16	20	28	40
Operating Temperature Range	-55 $^{\circ}\text{C}$ to +125 $^{\circ}\text{C}$									
Failure Rate	1%/ 1000H (85 $^{\circ}\text{C}$, Rated Voltage, 0.1 Ω / V)									

Capacitance and Voltage Range

Capacitance		Capacitance Range (letter denotes case code)								
		Rated Voltage								
μF	CODE	2.5V	4V	6.3V	10V	16V	20V	25V	35V	50V
0.1	104								A	A
0.15	154								A	A/B
0.22	224								A	A/B
0.33	334								A	B
0.47	474							A	A/B	A/B/C
0.68	684							A	A/B	A/B/C
1.0	105						A	A	A/B	A/B/C
1.5	155						A	A/B	A/B/C	C/D
2.2	225					A	A/B	A/B	A/B/C	C/D
3.3	335					A/B	A/B	A/B	B/C	C/D
4.7	475				A	A/B	A/B	A/B	B/C/D	C/D
6.8	685				A	A/B	A/B/C	B/C	C/D	C/D
10	106			A	A	A/B/C	B/C	B/C/D	C/D/E	D/E/V
15	156			A	A/B	A/B/C	B/C	C/D	C/D	D/E/V
22	226			A	A/B	B/C/D	B/C/D	C/D	D/E	V
33	336	A	A	A	A/B/C	B/C/D	C/D	D/E	D/E/V	
47	476	A	A	A/B/C	B/C	C/D	C/D/E	D/E	E/V	
68	686	A	A/B	B/C	B/C	C/D	D/E	E/V	V	
100	107	A/B	A/B	B/C	B/C/D	C/D/E	D/E/V	E/V		
150	157	B	B/C	B/C/D	C/D/E	D/E/V	E/V			
220	227	B/D	B/C/D	C/D/E	C/D/E	E/V				
330	337	D	C/D	C/D/E	D/E/V					
470	477	C/D	C/D/E	D/E/V	E/V					
680	687	C/D/E	D/E	E/V						
1000	108	D/E	D/E/V	V						
1500	158	D/E/V	E/V							
2200	228	V								

Note: Voltage ratings are minimum values. AVX reserves the right to supply higher voltage ratings in the same case size, to the same reliability standards.

Capacitance and Voltage Range (Low Profile)

Capacitance		Capacitance Range (letter denotes case code)								
		Rated Voltage								
μF	CODE	2.5V	4V	6.3V	10V	16V	20V	25V	35V	50V
0.1	104						R/S		R/S	S
0.15	154						R/S	R	R/S	S
0.22	224						R/S	R	R/S	S
0.33	334						R/S	R	R/S	S/T
0.47	474						R/S	R/S	R/S/T	S/T
0.68	684					R/S	R/S/T	R/S	P/S/T	
1.0	105				R/S	R/S/T	R/S/T	P/R/S	P/S/T	W
1.5	155			R/S	R/S	R/S	P/R/S/T	P/S/T	T	W
2.2	225		R/S	R/S	R/S	R/S/T	P/R/S/T	T	T	
3.3	335		R/S	R/S	R/S/T	R/S/T	T	T/W	W	Y
4.7	475	R	R/S	R/S/T	R/S/T	K/P/S/T	T	T/W	W	Y
6.8	685	R	R/S/T	R/S/T	P/R/S/T	S/T	T	W	Y	Y
10	106	R/S	R/S/T	P/R/S/T	K/P/R/S/T	T/W	W	W	X/Y	
15	156	R	R/S/T	K/P/R/S/T	S/T/W	T/W	W	Y	Y	
22	226	P/R	K/P/R/S/T	K/P/S/T/W	T/W	W	W/Y	Y	Y	
33	336	K/P/S	K/P/S/T/W	T/W	W	Y/W	X/Y	Y		
47	476	P/S	T/W	T/W	Y/W	W/X/Y	X/Y	Y		
68	686	T	T/W	W	W/Y	F/X/Y	Y			
100	107	T/W	T/W	W/Y	W/X/Y	F/Y				
150	157	T/W	Y/W	W/X/Y	F/X/Y	Y				
220	227	W/Y	Y/W/X	F/X/Y	Y					
330	337	W/Y	F/X/Y	Y						
470	477	F/Y	Y	Y						
680	687	Y	Y							
1000	108	Y								

Note: Voltage ratings are minimum values. AVX reserves the right to supply higher voltage ratings in the same case size, to the same reliability standards.

Capacitance and Voltage Range (ESR)

Capacitance		Capacitance and Voltage Range (Letter Denotes Case Code)								
		Rated Voltage D C (VR) at 85°C								
µF	CODE	2.5V	4V	6.3V	10V	16V	20V	25V	35V	50V
0.15	154									A (9000)
0.22	224								A (6000)	A (7000)
0.33	334								A (6000)	
0.47	474							A (7000)	A (6000) B (4000)	C (2300)
0.68	684							A (6000)	A (6000)	
1.0	105				R (9000)		A (3000) R (6000) S (6000) T (2000)	R (2500, 4000)	A (3000) B (2000)	C (2500)
1.5	155							A (3000) B (1800)	B (2500)	C (1500, 2000)
2.2	225			R (7000)	A (1800)	A (1800, 3500) T (2000)	A (3000)	B (900, 1200, 2500)	A (1500) B (750, 1500, 2000) C (1000)	D (1200)
3.3	335				T (1500)	A (3500)	A (2500) B (1300)	A (1000, 1500) B (750, 1500, 2000)	B (1000) C (700)	D (800)
4.7	475			S (4000)	A (1400) R (3000, 5000)	A (2000) B (800, 1500)	A (1800) B (750, 1000)	B (700, 900, 1500)	B (700, 1500) C (600) D (700)	D (300, 500, 700)
6.8	685			A (1800)	A (1800) T (1800)	A (1500) B (600, 1200)	A (1000) B (600, 1000) C (700)	B (700) C (500, 600, 700)	C (350) D (150, 400, 500)	D (200, 300, 500, 600)
10	106		R (3000)	A (1500) R (1000, 1500, 3000) T (1000)	A (900, 1800) P (2000) T (1000, 2000)	B (500, 800) C (500) T (800, 1000) W (500, 600)	B (500, 1000) C (500, 700) W (500)	B (1800) C (300, 500)	D (125, 300) E (200) Y (250)	E (400, 500) D (140) E (120)
15	156			A (700, 1500)	A (1000) B (450, 600) T (1200)	B (500, 800)	B (500) C (400, 450)	C (220, 300) D (100, 300)	C (350, 450) D (100, 300) Y (250)	E (250), V (250) E (75, 100)
22	226			A (500, 900) B (375, 600) S (900)	A (900) B (400, 500, 700) C (300), T (800)	B (400, 600) C (150, 250, 300, 375) W (500)	B (400, 600) C (100, 150, 400) D (200, 300)	C (275, 400) D (100, 200, 300)	D (125, 200, 300, 400) E (125, 200, 300) Y (200) E (60, 100)	E (75, 100)
33	336			A (600) B (250, 350, 450, 600) T (800)	A (700) B (250, 425, 500, 650) C (150, 375, 500) W (350)	B (350, 500) C (100, 150, 225, 300) D (200) W (140, 175, 250, 400, 500) Y (300, 400)	C (300) D (100, 200)	D (100, 200, 300) E (100, 175, 200, 300) Y (200)	D (200, 300) E (100, 250, 300) V (200) E (50, 65)	
47	476		A (500)	A (800) B (250, 350, 500) C (300) T (1200)	B (250, 350, 500, 650) C (200, 350) D (100) W (125, 150, 250)	C (110, 350) D (80, 100, 150, 200) W (200) X (180) Y (250)	D (75, 100, 200) E (70, 125, 150, 200, 250)	D (125, 150, 250) E (80, 100, 125)	E (200, 250) V (150, 200) E (55, 65)	
68	686			B (250, 350, 500) C (150, 200) W (110, 125, 250)	B (600) C (80, 100, 200, 300) D (100, 150) W (100, 150) Y (100, 200)	C (125, 200) D (70, 100, 150) F (200) X (150) Y (150, 200, 250)	D (70, 150, 200, 300) E (125, 150, 200)	E (125, 200) V (80, 95, 150, 200) E (45, 55)	V (150, 200)	
100	107	B (200)	B (200, 250, 350, 500) W (100)	B (250, 400) C (75, 150) W (100, 150) Y (100)	C (75, 100, 150, 200) D (50, 65, 80, 100, 125, 150) E (125) W (150) X (85, 150, 200) Y (100, 150, 200) Y (45)	C (200) D (80, 100, 125, 150) E (55, 100, 125, 150) F (150, 200) Y (100, 150, 200)	D (85, 100, 150) E (100, 150, 200) V (60, 85, 100, 200) E (35, 45)	V (100)		
150	157	B (150)	B (250) C (70, 80)	C (50, 90, 150, 200, 250) D (50, 125) Y (40, 50)	D (50, 85, 100) E (100) F (200) X (100) Y (100, 150, 200) Y (45)	D (60, 85, 100, 125, 150) E (100) V (45, 75) Y (200) E (30, 40)	V (80) E (35)			
220	227	B (150, 200, 600) D (45)	D (40, 50, 100) Y (40, 50, 75)	C (70, 100, 125, 250) D (50, 100, 125) E (100) F (200) Y (100, 150) Y (30)	D (40, 50, 100, 150) E (50, 60, 70, 100, 125, 150) Y (100, 150, 200) D (35)	E (100, 150) V (50, 75, 100, 150) E (25, 40)				
330	337	Y (40)	C (100) D (35, 45, 100) F (200) X (100) D (25, 35)	C (80, 100) D (45, 50, 70, 100) E (50, 100, 125, 150) V (100) Y (100, 150) D (25, 35)	D (50, 65, 100, 150) E (40, 50, 60, 100) V (40, 60, 100) D (35) E (23, 35)					
470	477	D (35) F (200) Y (100)	D (45, 100) E (35, 45, 100) D (25, 35)	D (45, 60, 100, 200) E (45, 50, 60, 100, 200) V (40, 55, 100) Y (150) D (30) E (18, 23, 30)	E (45, 50, 60, 100, 200) V (40, 60, 100) E (23, 30)					
680	687	D (35, 50) E (35, 50) Y (100)	D (45, 60, 100) E (40, 60, 100) D (25) E (18, 23) E (40, 60)	E (45, 60, 100) V (35, 40, 50) E (18, 23), V (23)						
1000	108	E (30, 40) Y (100) D (25)	V (25, 35, 40, 50) D (25, 45) E (18, 23), V (18)	V (40, 50)						
1500	158	D (100) E (50) V (30, 40) E (12, 15, 18)		E (50, 75) V (50, 75) E (15, 18)						
2200	228	E (18)								

Note: Voltage ratings are minimum values. AVX reserves the right to supply higher voltage ratings in the same case size, to the same reliability standards.
Figures of parentheses shows the ESR.
Shaded portion indicates TPM series products.

Packaging

Tape and reel packaging for automatic component placement.
Please enter required suffix code, R or S on order.

• Reel

(Unit: mm)

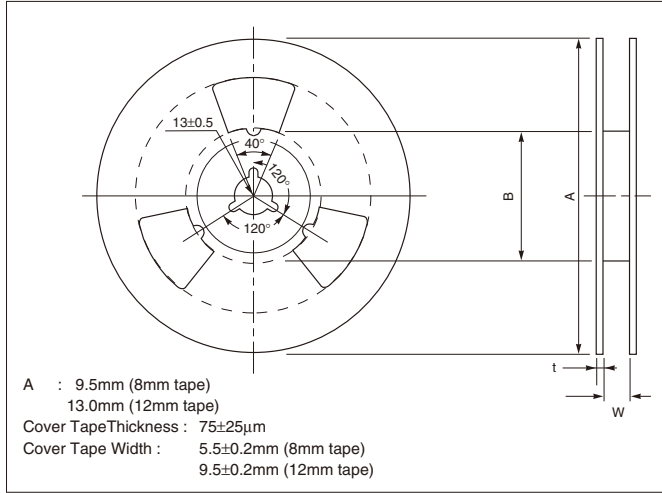

Reel Size	Tape width (mm)	A	B	C	W	t
180mm (7")	12	178±2.00	50 min.	13.0±0.50	12.4+1.5/-0	1.50±0.50
180mm (7")	8	178±2.00	50 min.	13.0±0.50	8.4+1.5/-0	1.50±0.50

• Taping

Series	Case Size	Tape Width (mm)	P (mm)	7" Reel (pcs.)
TAJ TPS TPM TCJ TLJ TRJ THJ NOJ NOS NOM NLJ	A	8	4	2000
	B	8	4	2000
	C	12	8	500
	D	12	8	500
	E	12	8	400
	F	12	8	1000
	G	8	4	2500
	H	8	4	2500
	J	8	4	4000
	K	8	4	3000
	P	8	4	2500
	R	8	4	2500
	S	8	4	2500
	T	8	4	2500
	V	12	8	400
	W	12	8	1000
	X	12	8	1000
Y	12	8	1000	

• Carrier Tape

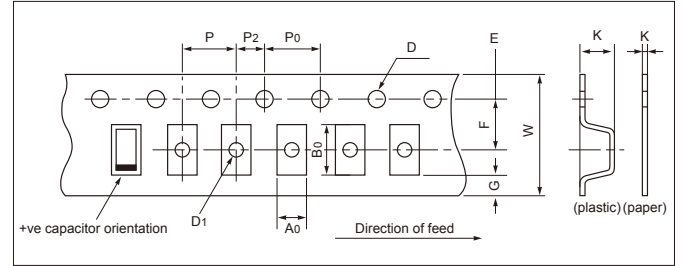

Tape dimensions comply to EIA 481 A.
Dimensions A₀ and B₀ of the pocket and the tape thickness, K, are dependent on the components size.
Tape material do not affect component solderability during storage.
Carrier tape thickness < 0.4mm.

(Unit: mm)

Code	8mm tape	12mm tape
P	4±0.1	8±0.1
G	0.75 min.	0.75 min.
F	3.5±0.05	5.5±0.05
E	1.75±0.1	1.75±0.1
W	8±0.3	12±0.3
P ₂	2±0.05	2±0.05
P ₀	4±0.1	4±0.1
D	1.5 ^{+0.2} / _{-0.0}	1.5 ^{+0.2} / _{-0.0}
D ₁	1.0 min.	1.5 min.

• Carrier Tape

(Unit: mm)

Series	Case Size	A ₀	B ₀	K
TAJ TPS TPM TCJ TLJ TRJ THJ NOJ NOS NOM NLJ	A	1.83±0.1	3.57±0.1	1.87±0.1
	B	3.15±0.1	3.77±0.1	2.22±0.1
	C	3.45±0.1	6.4±0.1	2.92±0.1
	D	4.48±0.1	7.62±0.1	3.22±0.1
	E	4.5±0.1	7.5±0.1	4.5±0.1
	F	3.35±0.1	6.4±0.1	2.2±0.1
	G	1.83±0.1	3.57±0.1	1.65±0.1
	H	3.15±0.1	3.77±0.1	1.66±0.1
	J	1.0±0.05	1.8±0.05	1.0±0.05
	K	1.95±0.1	3.55±0.1	1.15±0.1
	P	1.65±0.1	2.45±0.1	1.6±0.1
	R	1.65±0.1	2.45±0.1	1.3±0.1
	S	1.95±0.1	3.55±0.1	1.3±0.1
	T	3.2±0.1	3.8±0.1	1.3±0.1
	V	6.43±0.1	7.44±0.1	3.84±0.1
	W	3.57±0.1	6.4±0.1	1.65±0.1
	X	4.67±0.1	7.62±0.1	1.65±0.1
Y	4.67±0.1	7.62±0.1	2.15±0.1	

Recommended Land Pattern

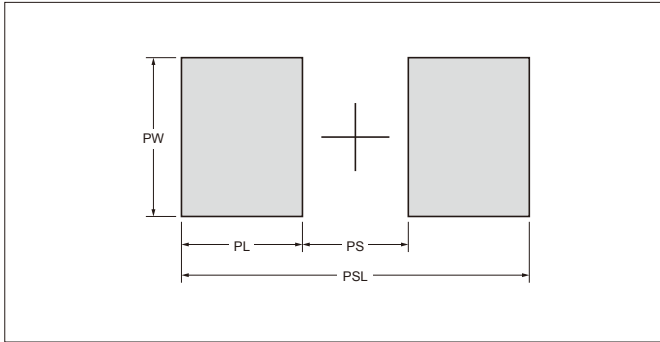

(Unit: mm)

Series	Case Size	PSL	PL	PS	PW
TAJ TPS TPM TCJ TLJ TRJ THJ NOJ NOS NOM NLJ	A	4.00	1.40	1.20	1.80
	B	4.00	1.40	1.20	2.80
	C	6.50	2.00	2.50	2.80
	D	8.00	2.00	4.00	3.00
	E	8.00	2.00	4.00	3.00
	F	6.50	2.00	2.50	2.80
	G	4.00	1.40	1.20	1.80
	H	4.00	1.40	1.20	2.80
	J	2.80	1.10	0.60	1.00
	K	4.00	1.40	1.20	1.80
	N	2.70	0.95	0.80	1.60
	P	2.70	0.95	0.80	1.60
	R	2.70	0.95	0.80	1.60
	S	4.00	1.40	1.20	1.80
	T	4.00	1.40	1.20	2.80
	V	8.00	2.00	4.00	3.70
	W	6.50	2.00	2.50	2.80
	X	8.00	2.00	4.00	3.00
Y	8.00	2.00	4.00	3.00	
Z	8.00	2.00	4.00	3.00	

Recommended Reflow Profile for Lead-Free Product

Allowable range of peak temp./ time combination for IR reflow

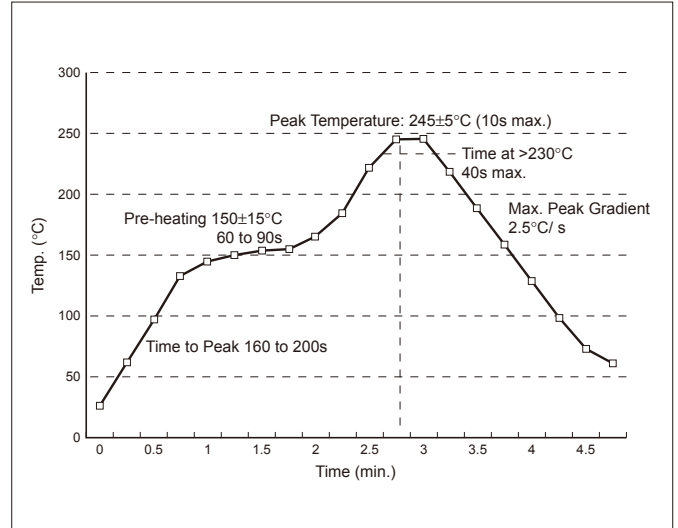

Please contact us for Lead-Free Products.

Manual Soldering Using Soldering Iron

Item	Condition
Max. Tip Temperature	370°C max.
Max. Exposure Time	3 sec. max.

Technical Summary

- Voltage Derating**
 We can offer to use AVX software "Select-a-Cap" to select a part number for safety use.
- Surge Current**
 As a general rule of thumb, the maximum current a tantalum capacitor can withstand is given by the following equation.

$$I_{max} = V_{rated} / (0.65 + \text{Catalog ESR})$$
 So for example for D case/ 100uF/ 10V capacitor (Catalog ESR = 0.9 Ohms)
 This would be :

$$I_{max} = 10 / (0.65 + 0.9) \approx 6.45\text{Amps}$$
- If more aggressive mounting techniques are to be used, please contact AVX Tantalum for guidance.
- Reverse Voltage**
 The values quoted are not intended to cover continuous reverse operation.
 The peak reverse voltage applied to the capacitor must not exceed.
 - 10% of rated DC voltage to a maximum of 1V at 25°C.
 - 3% of rated DC voltage to a maximum of 0.5V at 85°C.
 - 1% of category DC voltage to a maximum of 0.1V at 125°C.