

## 4-CHANNEL ESD SOLUTION FOR USB-HS/USB OTG/USB CHARGER INTERFACE

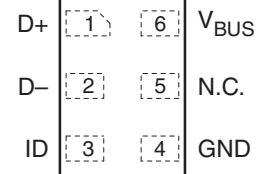
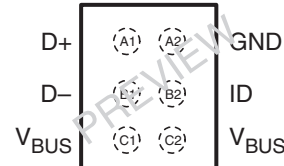
Check for Samples: [TPD4S012](#)

### FEATURES

- Integrated ESD Clamps for D+, D–, V<sub>BUS</sub>, and ID Pins to Provide Single-Chip ESD Protection for USB High Speed, USB-OTG, and USB Charger Interface
- Special Snap Back Technology Allows High-voltage Tolerance During Normal Operation while Reducing the Clamp Voltage during System Level ESD Stress
- USB Signal Pins (D+, D–, ID)
  - 0.8-pF Line Capacitance
  - Tolerates 6 V Signal
- V<sub>BUS</sub> Line (V<sub>BUS</sub>)
  - 11-pF Line Capacitance
  - Tolerates 20 V Signal
- Flow-Through Pin Mapping for the High-Speed Lines Ensures Zero Additional Skew Due to Board Layout While Placing the ESD Protection Chip Near the Connector
- Supports Data Rates in Excess of 480 Mbps
- IEC 61000-4-2 (Level 4) System Level ESD Compliance Measured at the D+, D–, and ID Pins
  - $\hat{A}\pm 10$ -kV IEC 61000-4-2 Contact Discharge
  - $\hat{A}\pm 10$ -kV IEC 61000-4-2 Air-Gap Discharge
- 3 Amps Peak Pulse Current (8/20  $\mu$ s Pulse) for V<sub>BUS</sub> and D+, D–, and ID Lines
- Industrial Temperature Range: –40°C to 85°C

### APPLICATIONS

- Cellular Phones
- Digital Cameras
- Global Positioning Systems (GPS)
- Portable Digital Assistants (PDA)
- Portable Computers

**DRY PACKAGE  
(TOP VIEW)**

**YFP PACKAGE  
(TOP VIEW)**


N.C. – Not internally connected

D+, D–, and ID pins are exact equivalent ESD clamp circuits. Any of these pins can be connected to any other D+, D–, or ID pin if it becomes easier to route the traces from the USB connector.

### DESCRIPTION

The TPD4S012 is a four-channel electrostatic discharge (ESD) solution for USB charger or USB on-the-go (OTG) interface. In many cell phone applications, the USB connector is the de facto communication port for external communications like high-speed data transfer, audio signal, charging, car-kit, etc. In order to support different interfaces, the USB port needs to handle different voltage levels. For example, some chargers require the V<sub>BUS</sub> port of the USB connector to handle in excess of the normal V<sub>BUS</sub> voltage per USB specifications. The TPD4S012 offers combinations of two different clamp voltages to match the voltage tolerances of the different signal interfaces using the common USB connector. Refer to Figure 5-6 & Figure 9-12, special snap back technology allows high-voltage tolerance during normal operation while reducing the clamp voltage during system level ESD stress.

The TPD4S012 conforms to IEC61000-4-2 (Level 4) ESD. The device is offered in space-saving packages with flow-through pin mapping.

The TPD4S012 is characterized for operation over ambient air temperature of –40°C to 85°C.



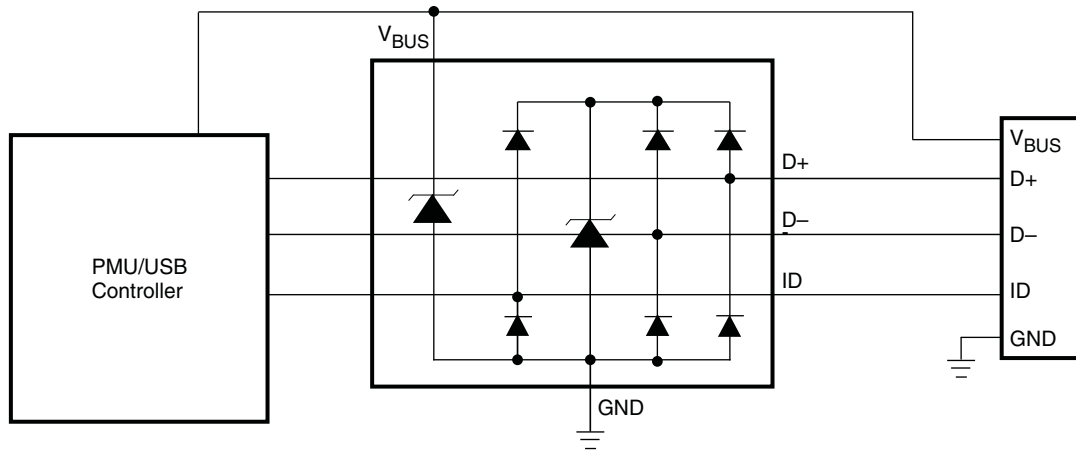
Please be aware that an important notice concerning availability, standard warranty, and use in critical applications of Texas Instruments semiconductor products and disclaimers thereto appears at the end of this data sheet.

**ORDERING INFORMATION**

T <sub>A</sub>	PACKAGE (1) (2)		NOMINAL DIMENSIONS (mm)	ORDERABLE PART NUMBER	TOP-SIDE MARKING
	SON – DRY	Reel of 3000			
–40°C to 85°C	SON – DRY	Reel of 3000	W = 1.0, L = 1.45, H = 0.55, Pitch = 0.5	TPD4S012DRYR	3B
	WCSP – XXX	Reel of 3000	W = 0.8, L = 1.2, H = 0.5, Pitch = 0.4	TPD4S012XXXR	TBD

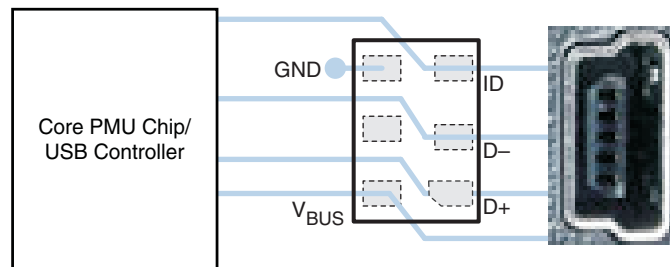
- (1) Package drawings, thermal data, and symbolization are available at [www.ti.com/packaging](http://www.ti.com/packaging).
- (2) For the most current package and ordering information, see the Package Option Addendum at the end of this document, or see the TI website at [www.ti.com](http://www.ti.com).

**APPLICATION SCHEMATIC**

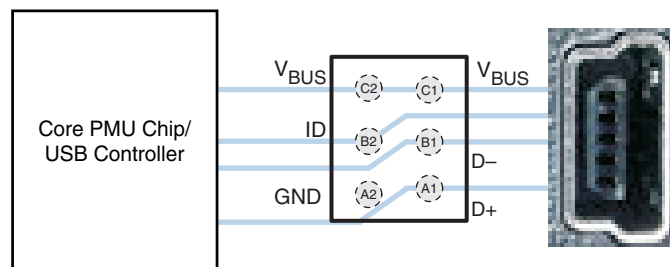


If the ID pin is not used, it can be left floating.

**Board Layout Recommendations**

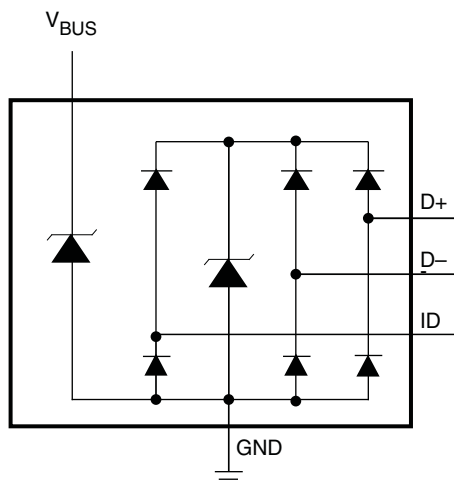


**Figure 1. Using DRY Package**



**Figure 2. Using YFP Package**

The TPD4S012 can provide system-level ESD protection to the high-speed differential ports. The flow-through package offers flexibility for board routing. Figure 1 and Figure 2 show the board layout scheme for the D+ and D– lines of a single differential pair. It allows the differential signal pairs couple together right after they touch the ESD ports of the TPD4S012.

**CIRCUIT DIAGRAM**

**TERMINAL FUNCTIONS**

TERMINAL			TYPE	DESCRIPTION
DRY PIN NO.	XXX BALL NO.	NAME		
1	A1	D+	ESD clamp	Provides ESD protection to the high-speed differential data lines
2	B1	D-	ESD clamp	Provides ESD protection to the high-speed differential data lines
3	B2	ID	ESD clamp	Provides ESD protection to the high-speed differential data lines
4	A2	GND	Pwr	Ground
5	–	N.C.	–	Not internally connected
6	C1, C2	V <sub>BUS</sub>	ESD clamp	ESD clamp for high-voltage tolerant V <sub>BUS</sub> line(s)

**ABSOLUTE MAXIMUM RATINGS**

over operating free-air temperature range (unless otherwise noted)

		MIN	MAX	UNIT
V <sub>BUS</sub> voltage tolerance	V <sub>BUS</sub> pin	-0.3	20	V
IO voltage tolerance	D+, D-, ID pins	-0.3	6	V
T <sub>stg</sub>	Storage temperature range	-65	125	°C
T <sub>A</sub>	Operating free-air temperature range	-40	85	°C
	IEC 61000-4-2 Contact Discharge		±10	kV
	IEC 61000-4-2 Air-Gap Discharge		±10	kV
	IEC 61000-4-2 Contact Discharge		±10	kV
	IEC 61000-4-2 Air-Gap Discharge		±9	kV
	Peak pulse power (t <sub>p</sub> = 8/20 μs)		60	W
	Peak pulse current (t <sub>p</sub> = 8/20 μs)		3	A

### ELECTRICAL CHARACTERISTICS

over operating free-air temperature range (unless otherwise noted)

PARAMETER		TEST CONDITIONS		MIN	TYP	MAX	UNIT
$I_{V_{BUS}}$	$V_{BUS}$ operating current	$V_{BUS} = 5\text{ V}$	D+, D-, ID pins open		0.1	0.5	$\mu\text{A}$
		$V_{BUS} = 19\text{ V}$					
$I_{IO}$	IO port current	$V_{IO} = 2.5\text{ V}, V_{BUS} = 5\text{ V}$	D+, D-, ID pins		0.1	0.5	$\mu\text{A}$
$V_D$	Diode forward voltage	$I_{IO} = 8\text{ mA}$	D+, D-, ID pins (lower clamp diode)	0.6	0.8	0.95	V
$C_{V_{BUS}}$	$V_{BUS}$ pin capacitance	$V_{BUS} = 5\text{ V}$			11	15	pF
$C_{IO}$	IO capacitance	$V_{IO} = 2.5\text{ V}$	D+, D-, ID pins (DRY package)		0.8	1	pF
$R_{DYN}$	Dynamic resistance	$I_{IO} = 1.5\text{ A}$	D+, D-, ID, and $V_{BUS}$ pins, including central clamp diode during positive ESD pulse		1.2		$\Omega$
		$I_{IO} = 1\text{ A}$	D+, D-, ID, and $V_{BUS}$ pins, including central clamp diode during negative ESD pulse		1		
$V_{BR}$	Breakdown voltage	$I_{IO} = 1\text{ mA}$	D+, D-, ID pins	6	9		V
			$V_{BUS}$ pin(s)	20	24		

### TYPICAL CHARACTERISTICS

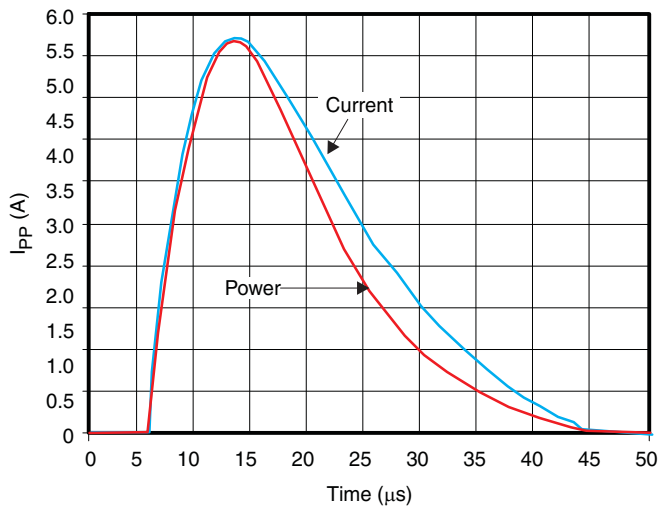


Figure 3. Peak Pulse Power Waveform at the D+, D-, or ID Pin

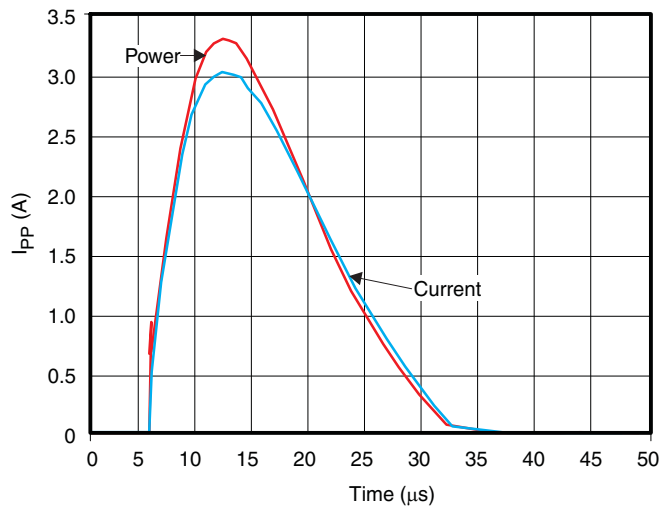


Figure 4. Peak Pulse Power Waveform at the  $V_{BUS}$  Pin

TYPICAL CHARACTERISTICS (continued)

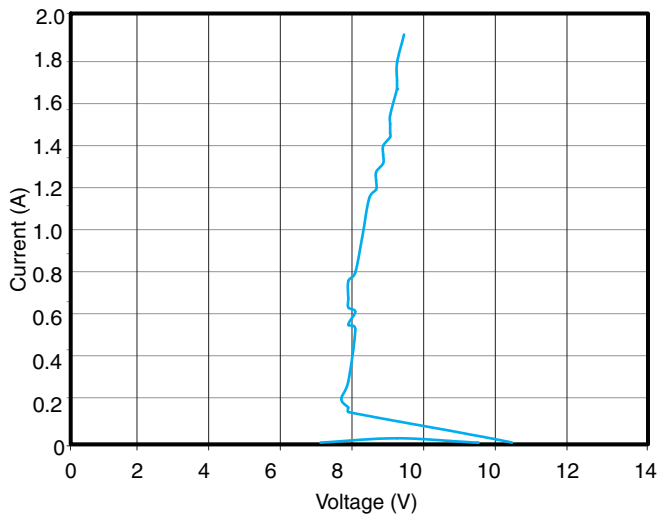


Figure 5. D+, D-, or ID Clamp Voltage Under ESD Event

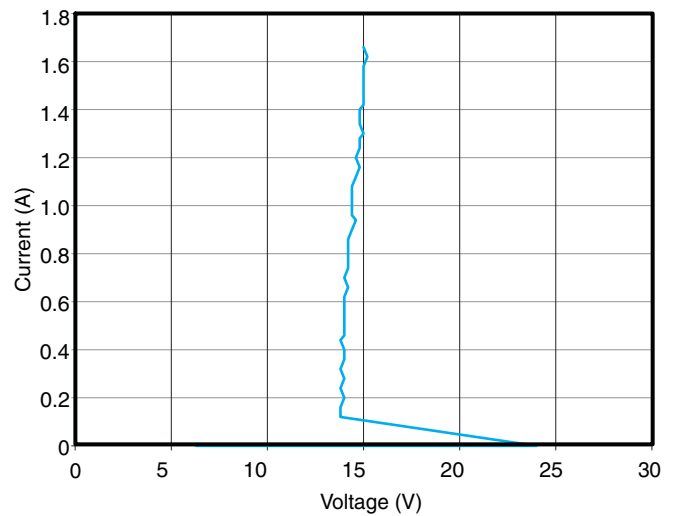


Figure 6. V<sub>BUS</sub> Clamp Voltage Under ESD Event

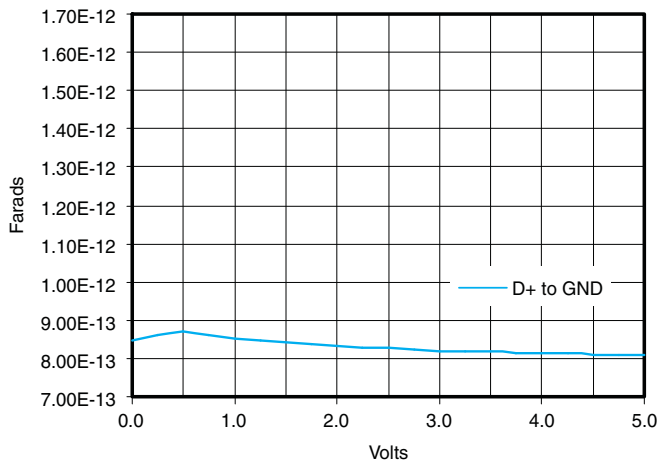


Figure 7. D+, D-, or ID Capacitance, T<sub>A</sub> = 27°C

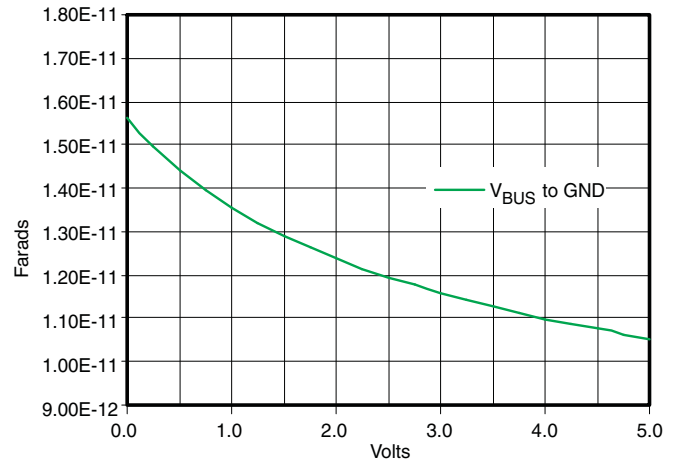


Figure 8. V<sub>BUS</sub> Capacitance, T<sub>A</sub> = 27°C

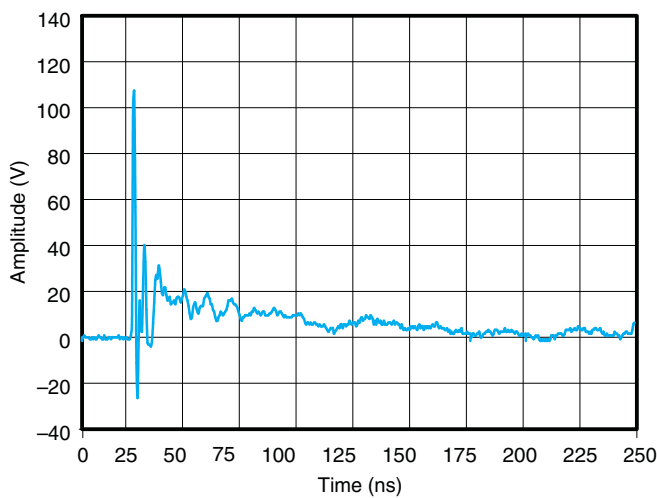


Figure 9. IEC Clamping Waveform, 8 kV Contact, D+, 25 ns/div

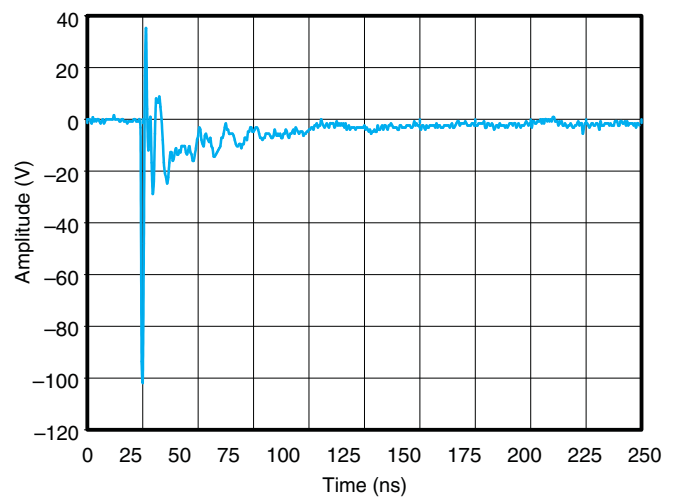


Figure 10. IEC Clamping Waveform, -8 kV Contact, D+, 25 ns/div

TYPICAL CHARACTERISTICS (continued)

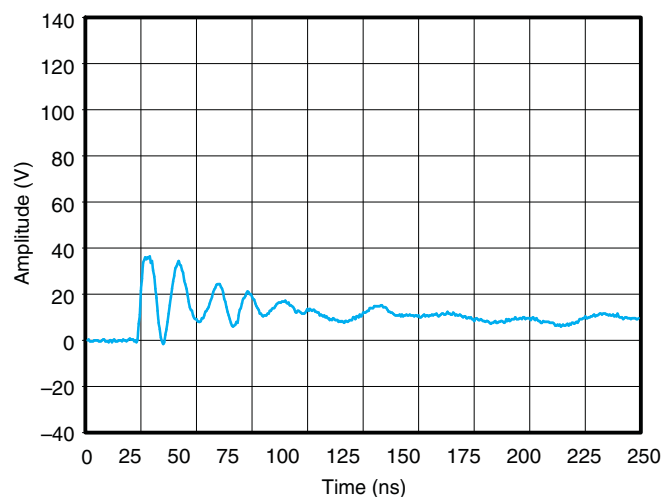


Figure 11.  $V_{BUS}$  IEC Clamping Waveform, 8 kV Contact, D+, 25 ns/div

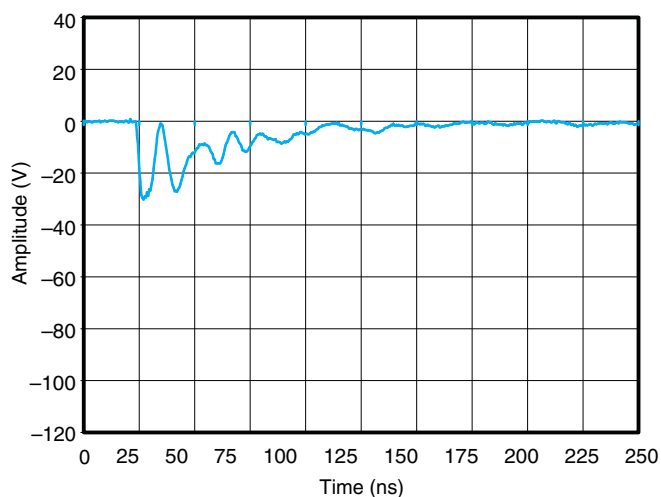


Figure 12.  $V_{BUS}$  IEC Clamping Waveform, -8 kV Contact, D+, 25 ns/div

**PACKAGING INFORMATION**

Orderable Device	Status <sup>(1)</sup>	Package Type	Package Drawing	Pins	Package Qty	Eco Plan <sup>(2)</sup>	Lead/ Ball Finish	MSL Peak Temp <sup>(3)</sup>	Samples (Requires Login)
TPD4S012DRYR	ACTIVE	SON	DRY	6	5000	TBD	Call TI	Call TI	<a href="#">Request Free Samples</a>

<sup>(1)</sup> The marketing status values are defined as follows:

**ACTIVE:** Product device recommended for new designs.

**LIFEBUY:** TI has announced that the device will be discontinued, and a lifetime-buy period is in effect.

**NRND:** Not recommended for new designs. Device is in production to support existing customers, but TI does not recommend using this part in a new design.

**PREVIEW:** Device has been announced but is not in production. Samples may or may not be available.

**OBSELETE:** TI has discontinued the production of the device.

<sup>(2)</sup> Eco Plan - The planned eco-friendly classification: Pb-Free (RoHS), Pb-Free (RoHS Exempt), or Green (RoHS & no Sb/Br) - please check <http://www.ti.com/productcontent> for the latest availability information and additional product content details.

**TBD:** The Pb-Free/Green conversion plan has not been defined.

**Pb-Free (RoHS):** TI's terms "Lead-Free" or "Pb-Free" mean semiconductor products that are compatible with the current RoHS requirements for all 6 substances, including the requirement that lead not exceed 0.1% by weight in homogeneous materials. Where designed to be soldered at high temperatures, TI Pb-Free products are suitable for use in specified lead-free processes.

**Pb-Free (RoHS Exempt):** This component has a RoHS exemption for either 1) lead-based flip-chip solder bumps used between the die and package, or 2) lead-based die adhesive used between the die and leadframe. The component is otherwise considered Pb-Free (RoHS compatible) as defined above.

**Green (RoHS & no Sb/Br):** TI defines "Green" to mean Pb-Free (RoHS compatible), and free of Bromine (Br) and Antimony (Sb) based flame retardants (Br or Sb do not exceed 0.1% by weight in homogeneous material)

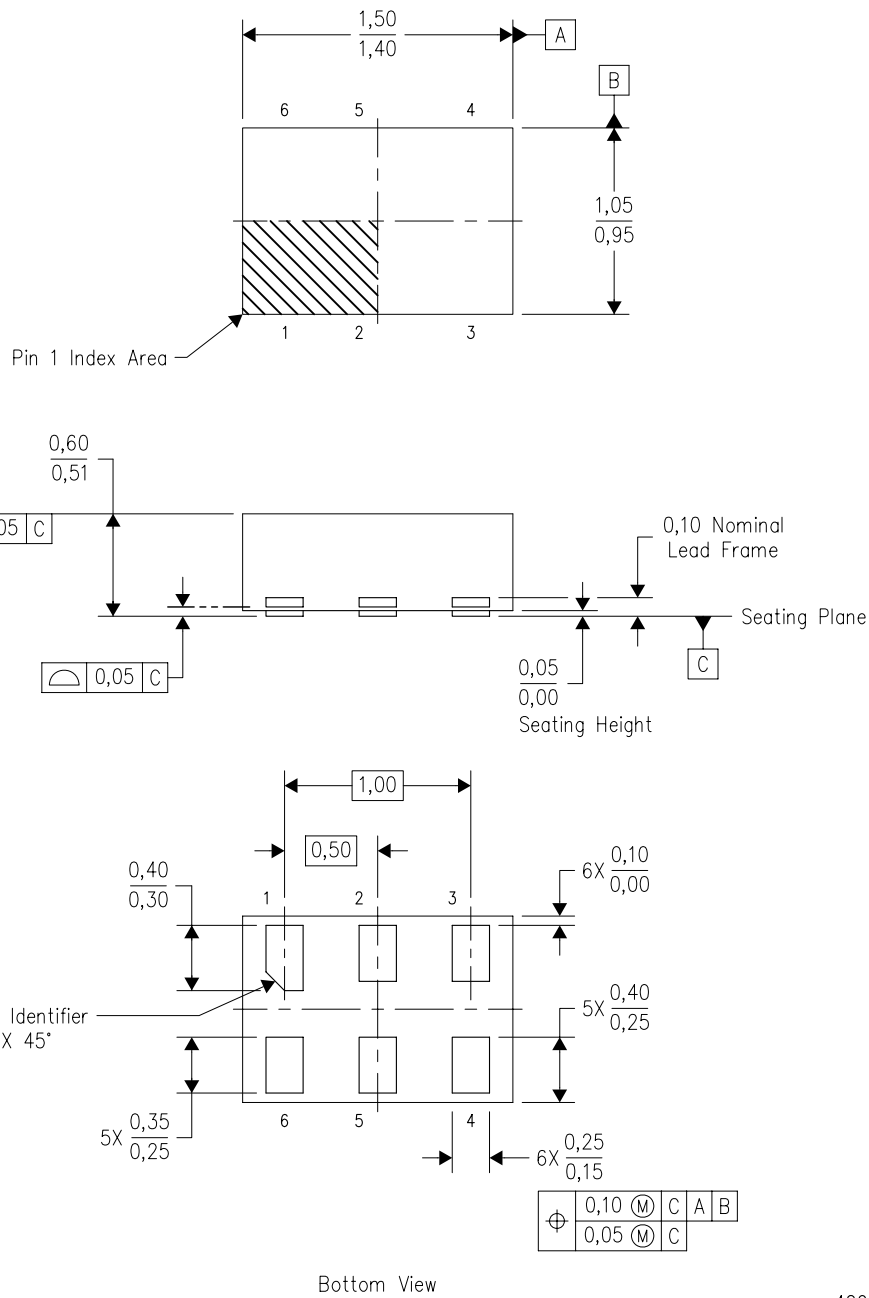
<sup>(3)</sup> MSL, Peak Temp. -- The Moisture Sensitivity Level rating according to the JEDEC industry standard classifications, and peak solder temperature.

**Important Information and Disclaimer:** The information provided on this page represents TI's knowledge and belief as of the date that it is provided. TI bases its knowledge and belief on information provided by third parties, and makes no representation or warranty as to the accuracy of such information. Efforts are underway to better integrate information from third parties. TI has taken and continues to take reasonable steps to provide representative and accurate information but may not have conducted destructive testing or chemical analysis on incoming materials and chemicals. TI and TI suppliers consider certain information to be proprietary, and thus CAS numbers and other limited information may not be available for release.

In no event shall TI's liability arising out of such information exceed the total purchase price of the TI part(s) at issue in this document sold by TI to Customer on an annual basis.

DRY (R-PUSON-N6)

PLASTIC SMALL OUTLINE NO-LEAD



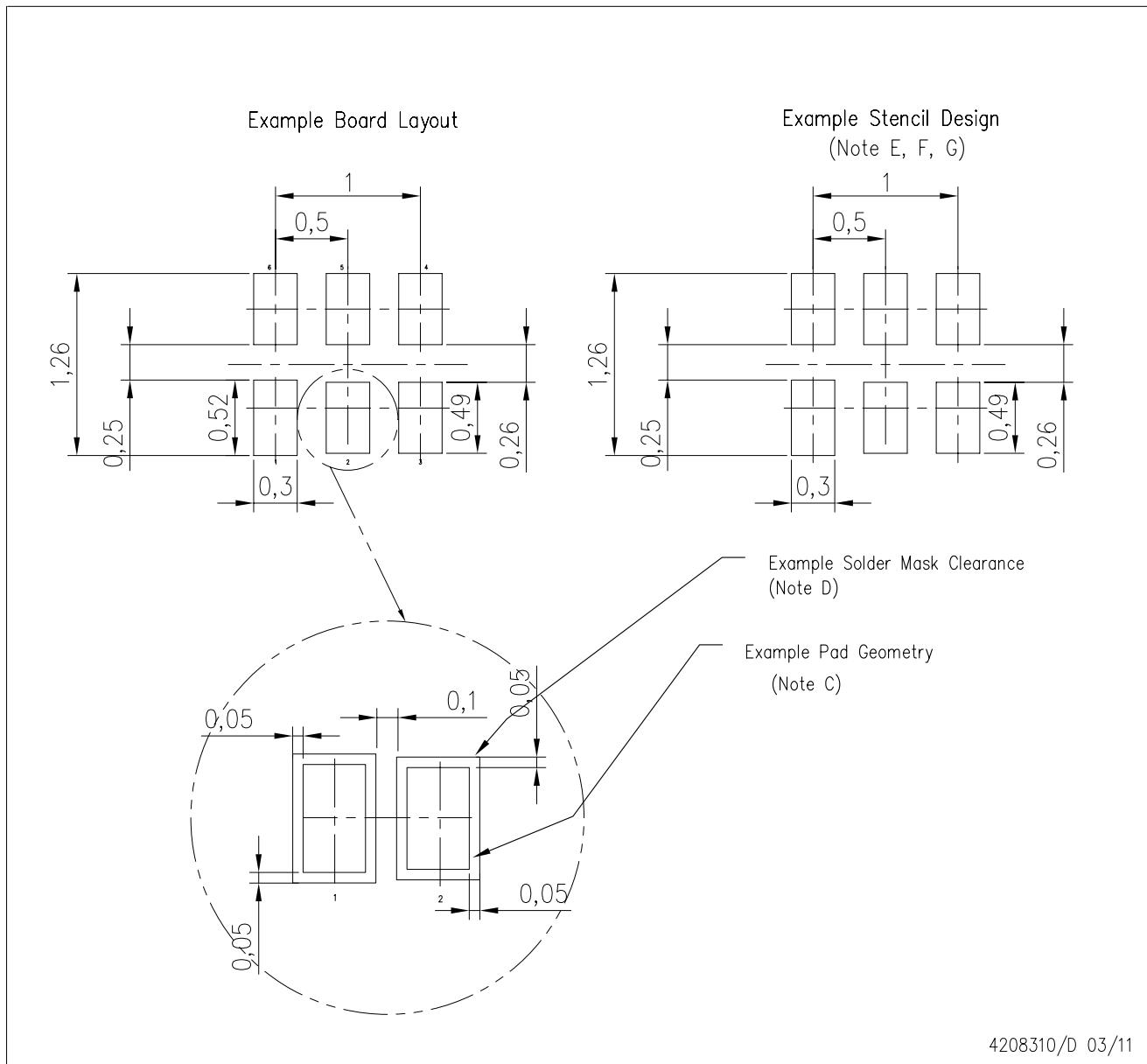
4207181/D 12/10

- NOTES:
- A. All linear dimensions are in millimeters. Dimensioning and tolerancing per ASME Y14.5M-1994.
  - B. This drawing is subject to change without notice.
  - C. SON (Small Outline No-Lead) package configuration.
  - D. This package complies to JEDEC MO-287 variation UFAD.



DRY (S-PUSON-N6)

PLASTIC SMALL OUTLINE NO-LEAD



- NOTES:
- All linear dimensions are in millimeters.
  - This drawing is subject to change without notice.
  - Publication IPC-7351 is recommended for alternate designs.
  - Customers should contact their board fabrication site for minimum solder mask web tolerances between signal pads.
  - Maximum stencil thickness 0,127 mm (5 mils). All linear dimensions are in millimeters.
  - Laser cutting apertures with trapezoidal walls and also rounding corners will offer better paste release. Customers should contact their board assembly site for stencil design recommendations. Refer to IPC 7525 for stencil design considerations.
  - Side aperture dimensions over-print land for acceptable area ratio > 0.66. Customer may reduce side aperture dimensions if stencil manufacturing process allows for sufficient release at smaller opening.

## IMPORTANT NOTICE

Texas Instruments Incorporated and its subsidiaries (TI) reserve the right to make corrections, modifications, enhancements, improvements, and other changes to its products and services at any time and to discontinue any product or service without notice. Customers should obtain the latest relevant information before placing orders and should verify that such information is current and complete. All products are sold subject to TI's terms and conditions of sale supplied at the time of order acknowledgment.

TI warrants performance of its hardware products to the specifications applicable at the time of sale in accordance with TI's standard warranty. Testing and other quality control techniques are used to the extent TI deems necessary to support this warranty. Except where mandated by government requirements, testing of all parameters of each product is not necessarily performed.

TI assumes no liability for applications assistance or customer product design. Customers are responsible for their products and applications using TI components. To minimize the risks associated with customer products and applications, customers should provide adequate design and operating safeguards.

TI does not warrant or represent that any license, either express or implied, is granted under any TI patent right, copyright, mask work right, or other TI intellectual property right relating to any combination, machine, or process in which TI products or services are used. Information published by TI regarding third-party products or services does not constitute a license from TI to use such products or services or a warranty or endorsement thereof. Use of such information may require a license from a third party under the patents or other intellectual property of the third party, or a license from TI under the patents or other intellectual property of TI.

Reproduction of TI information in TI data books or data sheets is permissible only if reproduction is without alteration and is accompanied by all associated warranties, conditions, limitations, and notices. Reproduction of this information with alteration is an unfair and deceptive business practice. TI is not responsible or liable for such altered documentation. Information of third parties may be subject to additional restrictions.

Resale of TI products or services with statements different from or beyond the parameters stated by TI for that product or service voids all express and any implied warranties for the associated TI product or service and is an unfair and deceptive business practice. TI is not responsible or liable for any such statements.

TI products are not authorized for use in safety-critical applications (such as life support) where a failure of the TI product would reasonably be expected to cause severe personal injury or death, unless officers of the parties have executed an agreement specifically governing such use. Buyers represent that they have all necessary expertise in the safety and regulatory ramifications of their applications, and acknowledge and agree that they are solely responsible for all legal, regulatory and safety-related requirements concerning their products and any use of TI products in such safety-critical applications, notwithstanding any applications-related information or support that may be provided by TI. Further, Buyers must fully indemnify TI and its representatives against any damages arising out of the use of TI products in such safety-critical applications.

TI products are neither designed nor intended for use in military/aerospace applications or environments unless the TI products are specifically designated by TI as military-grade or "enhanced plastic." Only products designated by TI as military-grade meet military specifications. Buyers acknowledge and agree that any such use of TI products which TI has not designated as military-grade is solely at the Buyer's risk, and that they are solely responsible for compliance with all legal and regulatory requirements in connection with such use.

TI products are neither designed nor intended for use in automotive applications or environments unless the specific TI products are designated by TI as compliant with ISO/TS 16949 requirements. Buyers acknowledge and agree that, if they use any non-designated products in automotive applications, TI will not be responsible for any failure to meet such requirements.

Following are URLs where you can obtain information on other Texas Instruments products and application solutions:

### Products

Audio	<a href="http://www.ti.com/audio">www.ti.com/audio</a>
Amplifiers	<a href="http://amplifier.ti.com">amplifier.ti.com</a>
Data Converters	<a href="http://dataconverter.ti.com">dataconverter.ti.com</a>
DLP® Products	<a href="http://www.dlp.com">www.dlp.com</a>
DSP	<a href="http://dsp.ti.com">dsp.ti.com</a>
Clocks and Timers	<a href="http://www.ti.com/clocks">www.ti.com/clocks</a>
Interface	<a href="http://interface.ti.com">interface.ti.com</a>
Logic	<a href="http://logic.ti.com">logic.ti.com</a>
Power Mgmt	<a href="http://power.ti.com">power.ti.com</a>
Microcontrollers	<a href="http://microcontroller.ti.com">microcontroller.ti.com</a>
RFID	<a href="http://www.ti-rfid.com">www.ti-rfid.com</a>
RF/IF and ZigBee® Solutions	<a href="http://www.ti.com/lprf">www.ti.com/lprf</a>

### Applications

Communications and Telecom	<a href="http://www.ti.com/communications">www.ti.com/communications</a>
Computers and Peripherals	<a href="http://www.ti.com/computers">www.ti.com/computers</a>
Consumer Electronics	<a href="http://www.ti.com/consumer-apps">www.ti.com/consumer-apps</a>
Energy and Lighting	<a href="http://www.ti.com/energy">www.ti.com/energy</a>
Industrial	<a href="http://www.ti.com/industrial">www.ti.com/industrial</a>
Medical	<a href="http://www.ti.com/medical">www.ti.com/medical</a>
Security	<a href="http://www.ti.com/security">www.ti.com/security</a>
Space, Avionics and Defense	<a href="http://www.ti.com/space-avionics-defense">www.ti.com/space-avionics-defense</a>
Transportation and Automotive	<a href="http://www.ti.com/automotive">www.ti.com/automotive</a>
Video and Imaging	<a href="http://www.ti.com/video">www.ti.com/video</a>
Wireless	<a href="http://www.ti.com/wireless-apps">www.ti.com/wireless-apps</a>

TI E2E Community Home Page

[e2e.ti.com](http://e2e.ti.com)

Mailing Address: Texas Instruments, Post Office Box 655303, Dallas, Texas 75265  
Copyright © 2011, Texas Instruments Incorporated