



150-mW STEREO AUDIO POWER AMPLIFIER

FEATURES

- 150 mW Stereo Output
- Differential Inputs
- PC Power Supply Compatible
 - Fully Specified for 3.3 V and 5 V Operation
 - Operation to 2.5 V
- Pop Reduction Circuitry
- Internal Mid-Rail Generation
- Thermal and Short-Circuit Protection
- Surface-Mount Packaging
 - PowerPAD™ MSOP

DGQ PACKAGE
(TOP VIEW)

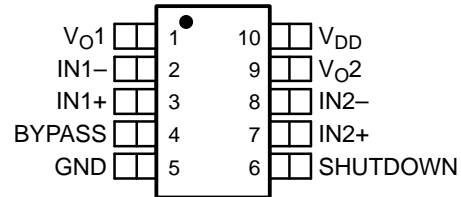

DESCRIPTION

The TPA6112A2 is a stereo audio power amplifier with differential inputs packaged in a 10-pin PowerPAD MSOP package capable of delivering 150 mW of continuous RMS power per channel into 16-Ω loads. Amplifier gain is externally configured by means of two resistors per input channel and does not require external compensation for settings of 1 to 10.

TYPICAL APPLICATION CIRCUIT

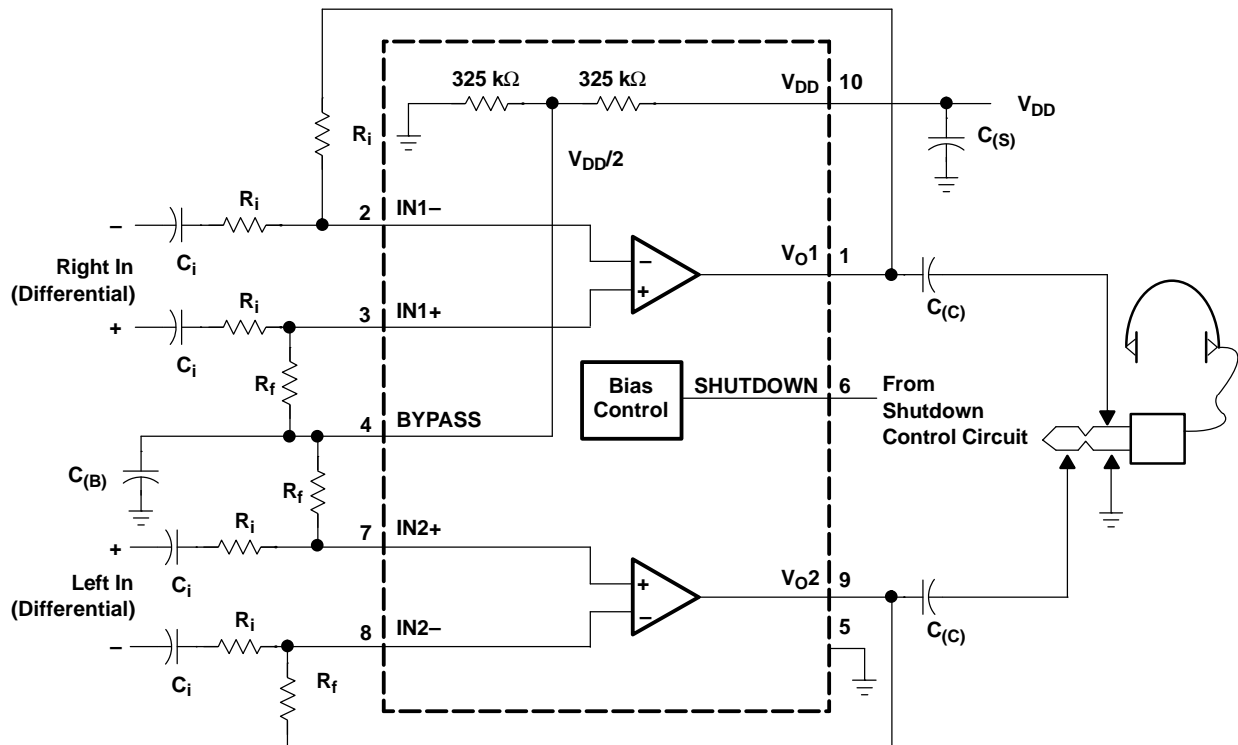

Please be aware that an important notice concerning availability, standard warranty, and use in critical applications of Texas Instruments semiconductor products and disclaimers thereto appears at the end of this data sheet.

PowerPAD is a trademark of Texas Instruments.



These devices have limited built-in ESD protection. The leads should be shorted together or the device placed in conductive foam during storage or handling to prevent electrostatic damage to the MOS gates.

DESCRIPTION (CONTINUED)

THD+N when driving an 16-Ω load from 5 V is 0.03% at 1 kHz, and less than 1% across the audio band of 20 Hz to 20 kHz. For 32-Ω loads, the THD+N is reduced to less than 0.02% at 1 kHz, and is less than 1% across the audio band of 20 Hz to 20 kHz. For 10-kΩ loads, the THD+N performance is 0.005% at 1 kHz, and less than 0.5% across the audio band of 20 Hz to 20 kHz.

AVAILABLE OPTIONS

T _A	PACKAGED DEVICE	MSOP SYMBOLIZATION
	MSOP ⁽¹⁾	
-40°C to 85°C	TPA6112A2DGQ	TI APD

(1) The DGQ package is available in left-ended tape and reel only (e.g., TPA6112A2DGQR).

Terminal Functions

TERMINAL NAME	NO	I/O	DESCRIPTION
BYPASS	4	I	Tap to voltage divider for internal mid-supply bias supply. Connect to a 0.1 μF to 1 μF low ESR capacitor for best performance.
GND	5	I	GND is the ground connection.
IN1-	2	I	IN1- is the negative input for channel 1.
IN1+	3	I	IN1+ is the positive input for channel 1.
IN2-	8	I	IN2- is the negative input for channel 2.
IN2+	7	I	IN2+ is the positive input for channel 2.
SHUTDOWN	6	I	Puts the device in a low quiescent current mode when held high.
V _{DD}	10	I	V _{DD} is the supply voltage terminal.
V _{O1}	1	O	V _{O1} is the audio output for channel 1.
V _{O2}	9	O	V _{O2} is the audio output for channel 2.

ABSOLUTE MAXIMUM RATINGS

over operating free-air temperature (unless otherwise noted⁽¹⁾)

		UNITS
V _{DD}	Supply voltage	6 V
V _I	Input voltage	-0.3 V to V _{DD} + 0.3 V
	Continuous total power dissipation	internally limited
T _J	Operating junction temperature range	-40°C to 150°C
T _{stg}	Storage temperature range	-65°C to 150°C
	Lead temperature 1,6 mm (1/16 inch) from case for 10 seconds	260°C

(1) Stresses beyond those listed under absolute maximum ratings may cause permanent damage to the device. These are stress ratings only, and functional operation of the device at these or any other conditions beyond those indicated under recommended operating conditions is not implied. Exposure to absolute-maximum-rated conditions for extended periods may affect device reliability.

DISSIPATION RATING TABLE

PACKAGE	T _A ≤ 25°C POWER RATING	DERATING FACTOR ABOVE T _A = 25°C	T _A = 70°C POWER RATING	T _A = 85°C POWER RATING
DGQ	2.14 W ⁽¹⁾	17.1 mW/°C	1.37 W	1.11 W

- (1) Please see the Texas Instruments document, *PowerPAD Thermally Enhanced Package Application Report* (literature number SLMA002), for more information on the PowerPAD package. The thermal data was measured on a PCB layout based on the information in the section entitled *Texas Instruments Recommended Board for PowerPAD* on page 33 of the before mentioned document.

RECOMMENDED OPERATING CONDITIONS

		MIN	MAX	UNIT
V _{DD}	Supply voltage	2.5	5.5	V
T _A	Operating free-air temperature	-40	85	°C
V _{IH} , (SHUTDOWN)	High-level input voltage	60% x V _{DD}		V
V _{IL} , (SHUTDOWN)	Low-level input voltage	25% x V _{DD}		V

DC ELECTRICAL CHARACTERISTICS

At T_A = 25°C, V_{DD} = 2.5 V (Unless Otherwise Noted)

PARAMETER		TEST CONDITIONS	MIN	TYP	MAX	UNIT
V _{OO}	Output offset voltage	A _V = 2 V/V			15	mV
PSRR	Power supply rejection ratio	V _{DD} = 3.2 V to 3.4 V		83		dB
I _{DD}	Supply current	SHUTDOWN = 0 V		1.5	3	mA
I _{DD(SD)}	Supply current in SHUTDOWN mode	SHUTDOWN = V _{DD}		10	50	μA
Z _i	Input impedance			>1		MΩ

AC OPERATING CHARACTERISTICS

V_{DD} = 3.3 V, T_A = 25°C, R_L = 16 Ω

PARAMETER		TEST CONDITIONS	MIN	TYP	MAX	UNIT
P _O	Output power (each channel)	THD ≤ 0.1%, f = 1 kHz		60		mW
THD+N	Total harmonic distortion + noise	P _O = 40 mW, 20 - 20 kHz		0.4%		
B _{OM}	Maximum output power BW	G = 10, THD < 5%		> 20		kHz
	Phase margin	Open loop		96°		
	Supply ripple rejection ratio	f = 1 kHz		71		dB
	Channel/channel output separation	f = 1 kHz		89		dB
SNR	Signal-to-noise ratio	P _O = 50 mW, A _V = 1		100		dB
V _n	Noise output voltage	A _V = 1		11		μV(rms)

DC ELECTRICAL CHARACTERISTICS

At T_A = 25°C, V_{DD} = 5.5 V (Unless otherwise noted)

PARAMETER		TEST CONDITIONS	MIN	TYP	MAX	UNIT
V _{OO}	Output offset voltage	A _V = 2 V/V			15	mV
PSRR	Power supply rejection ratio	V _{DD} = 4.9 V to 5.1 V		76		dB
I _{DD}	Supply current	SHUTDOWN = 0 V		1.5	3	mA
I _{DD(SD)}	Supply current in SHUTDOWN mode	SHUTDOWN = V _{DD}		60	100	μA
I _{IH}	High-level input current (SHUTDOWN)	V _{DD} = 5.5 V, V _I = V _{DD}			1	μA
I _{IL}	Low-level input current (SHUTDOWN)	V _{DD} = 5.5 V, V _I = 0 V			1	μA
Z _i	Input impedance			>1		MΩ

AC OPERATING CHARACTERISTICS $V_{DD} = 5\text{ V}$, $T_A = 25^\circ\text{C}$, $R_L = 16\ \Omega$

PARAMETER		TEST CONDITIONS	MIN	TYP	MAX	UNIT
P_O	Output power (each channel)	THD \leq 0.1%, $f = 1\text{ kHz}$		150		mW
THD+N	Total harmonic distortion + noise	$P_O = 100\text{ mW}$, 20 - 20 kHz		0.6%		
B_{OM}	Maximum output power BW	$G = 10$, THD < 5%		> 20		kHz
	Phase margin	Open loop		96°		
	Supply ripple rejection ratio	$f = 1\text{ kHz}$		61		dB
	Channel/channel output separation	$f = 1\text{ kHz}$		90		dB
SNR	Signal-to-noise ratio	$P_O = 100\text{ mW}$, $A_V = 1$		100		dB
V_n	Noise output voltage	$A_V = 1$		11.7		$\mu\text{V(rms)}$

AC OPERATING CHARACTERISTICS $V_{DD} = 3.3\text{ V}$, $T_A = 25^\circ\text{C}$, $R_L = 32\ \Omega$

PARAMETER		TEST CONDITIONS	MIN	TYP	MAX	UNIT
P_O	Output power (each channel)	THD \leq 0.1%, $f = 1\text{ kHz}$		40		mW
THD+N	Total harmonic distortion + noise	$P_O = 30\text{ mW}$, 20 - 20 kHz		0.4%		
B_{OM}	Maximum output power BW	$A_V = 10$, THD < 2%		> 20		kHz
	Phase margin	Open loop		96°		
	Supply ripple rejection ratio	$f = 1\text{ kHz}$		71		dB
	Channel/channel output separation	$f = 1\text{ kHz}$		95		dB
SNR	Signal-to-noise ratio	$P_O = 40\text{ mW}$, $A_V = 1$		100		dB
V_n	Noise output voltage	$A_V = 1$		11		$\mu\text{V(rms)}$

AC OPERATING CHARACTERISTICS $V_{DD} = 5\text{ V}$, $T_A = 25^\circ\text{C}$, $R_L = 32\ \Omega$

PARAMETER		TEST CONDITIONS	MIN	TYP	MAX	UNIT
P_O	Output power (each channel)	THD \leq 0.1%, $f = 1\text{ kHz}$		90		mW
THD+N	Total harmonic distortion + noise	$P_O = 60\text{ mW}$, 20 - 20 kHz		0.4%		
B_{OM}	Maximum output power BW	$A_V = 10$, THD < 2%		> 20		kHz
	Phase margin	Open loop		97°		
	Supply ripple rejection ratio	$f = 1\text{ kHz}$		61		dB
	Channel/channel output separation	$f = 1\text{ kHz}$		98		dB
SNR	Signal-to-noise ratio	$P_O = 90\text{ mW}$, $A_V = 1$		100		dB
V_n	Noise output voltage	$A_V = 1$		11.7		$\mu\text{V(rms)}$

TYPICAL CHARACTERISTICS

Table of Graphs

		FIGURE	
THD+N	Total harmonic distortion plus noise	vs Frequency	1, 3, 5, 6, 7, 9, 11, 13,
		vs Output power	2, 4, 8, 10, 12, 14
	Supply ripple rejection ratio	vs Frequency	15, 16
V_n	Output noise voltage	vs Frequency	17, 18
	Crosstalk	vs Frequency	19 - 24
	Shutdown attenuation	vs Frequency	25, 26
	Open-loop gain and phase margin	vs Frequency	27, 28
	Output power	vs Load resistance	29, 30,
I_{DD}	Supply current	vs Supply voltage	31
SNR	Signal-to-noise ratio	vs Voltage gain	32
	Power dissipation/amplifier	vs Load power	33, 34

TOTAL HARMONIC DISTORTION + NOISE
vs
FREQUENCY

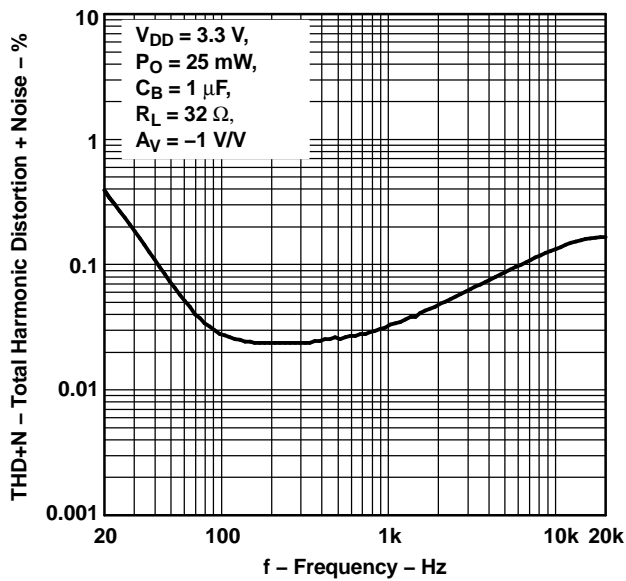

Figure 1.

TOTAL HARMONIC DISTORTION + NOISE
vs
OUTPUT POWER

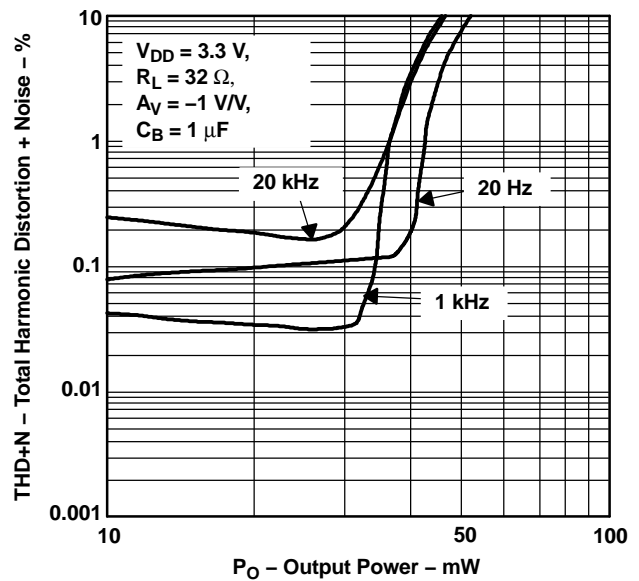

Figure 2.

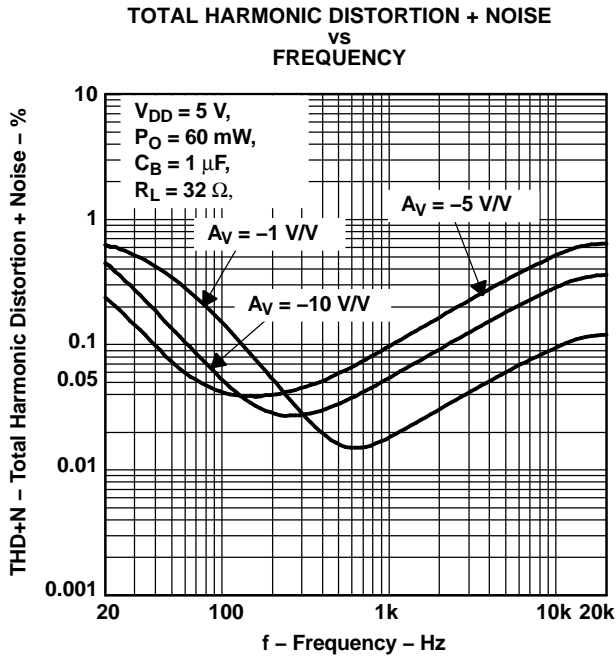

Figure 3.

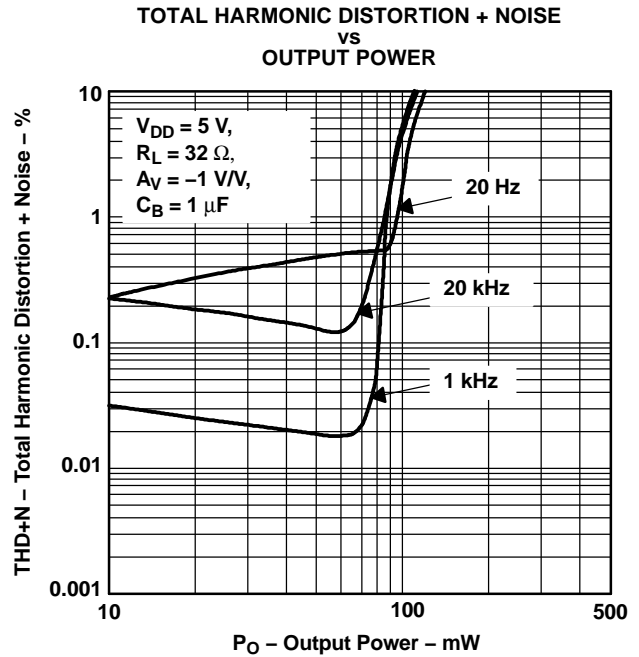

Figure 4.

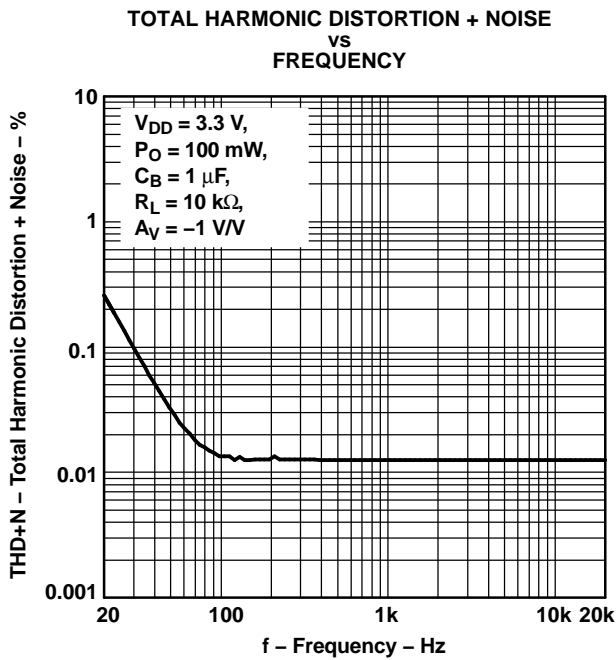

Figure 5.

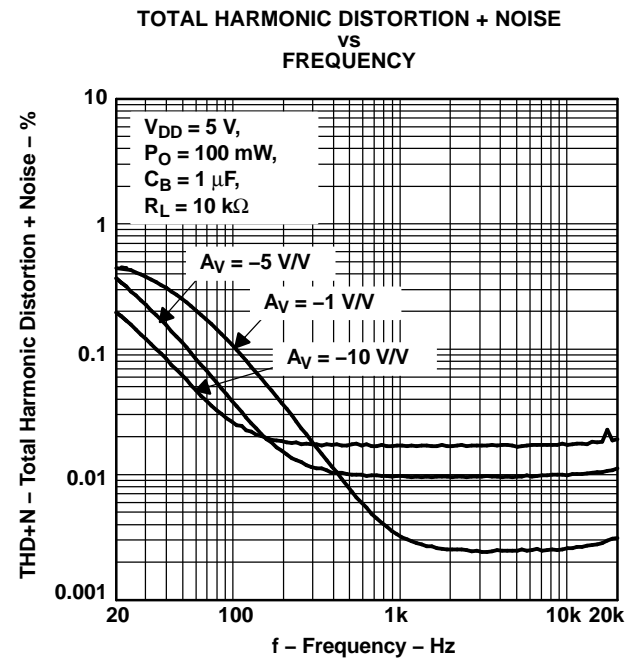

Figure 6.

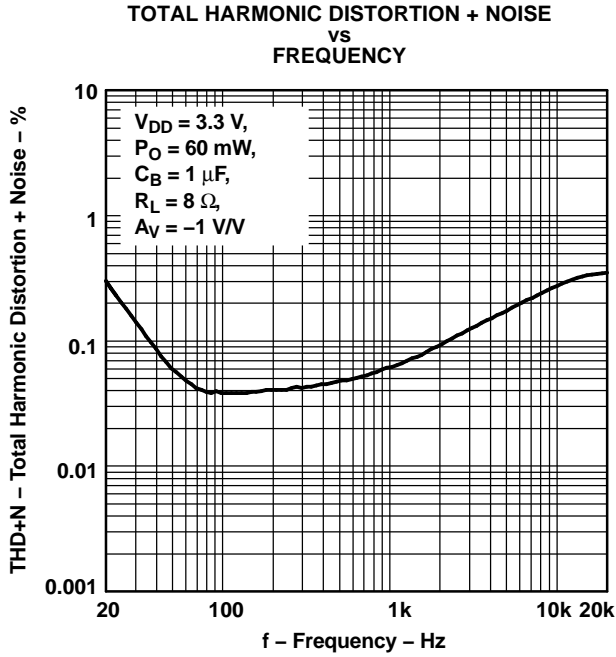

Figure 7.

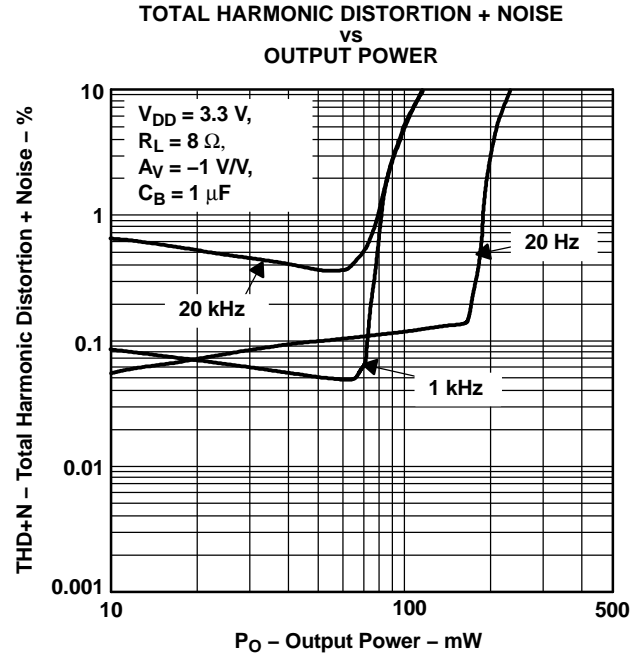

Figure 8.

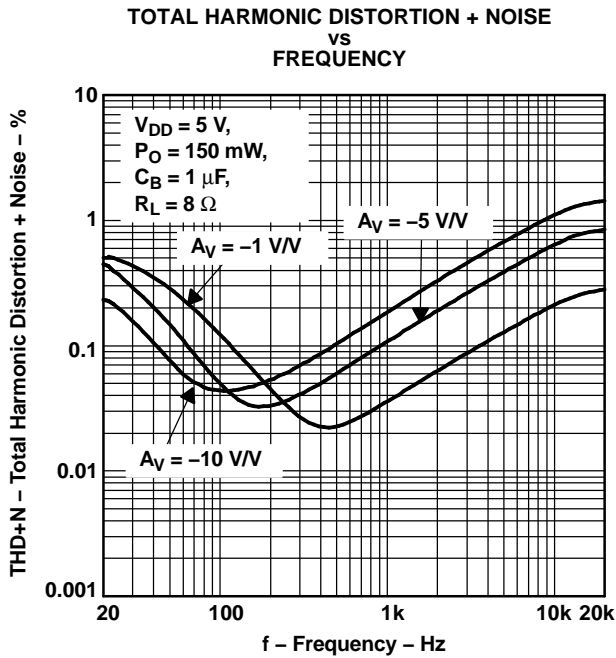

Figure 9.

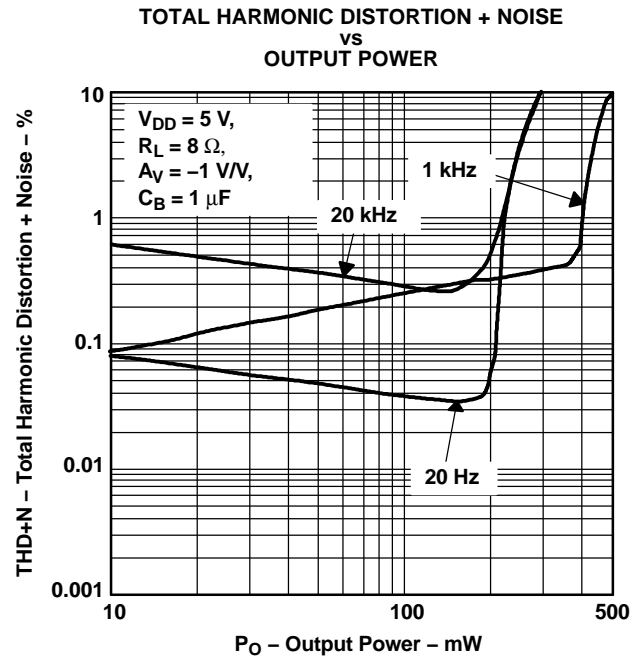

Figure 10.

TOTAL HARMONIC DISTORTION + NOISE
vs
FREQUENCY

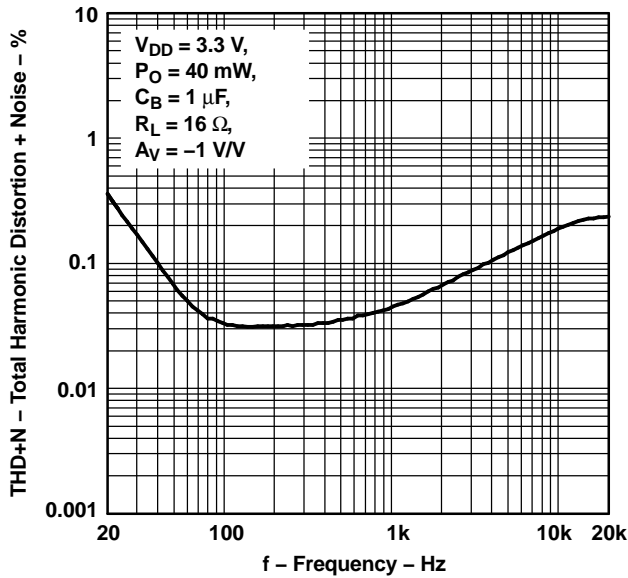

Figure 11.

TOTAL HARMONIC DISTORTION + NOISE
vs
OUTPUT POWER

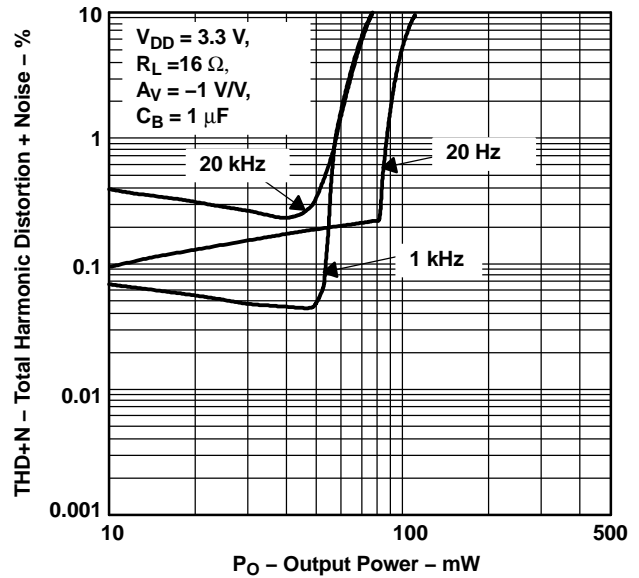

Figure 12.

TOTAL HARMONIC DISTORTION + NOISE
vs
FREQUENCY

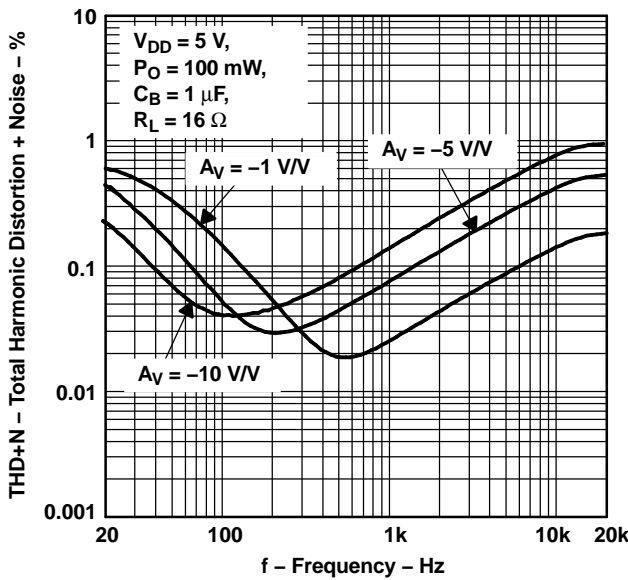

Figure 13.

TOTAL HARMONIC DISTORTION + NOISE
vs
OUTPUT POWER

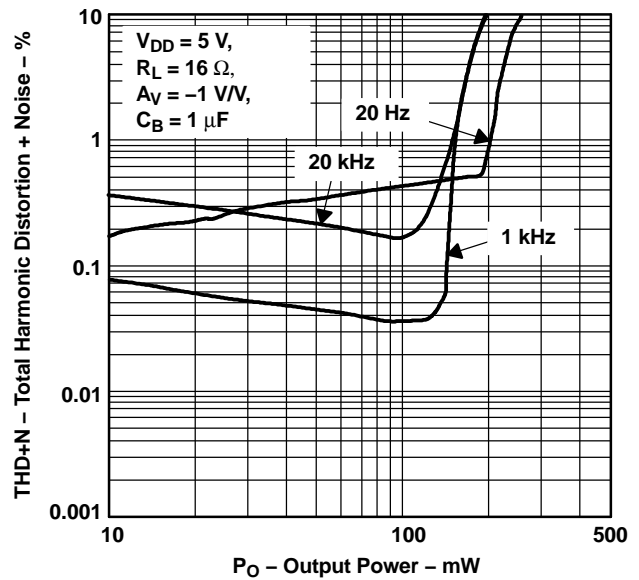

Figure 14.

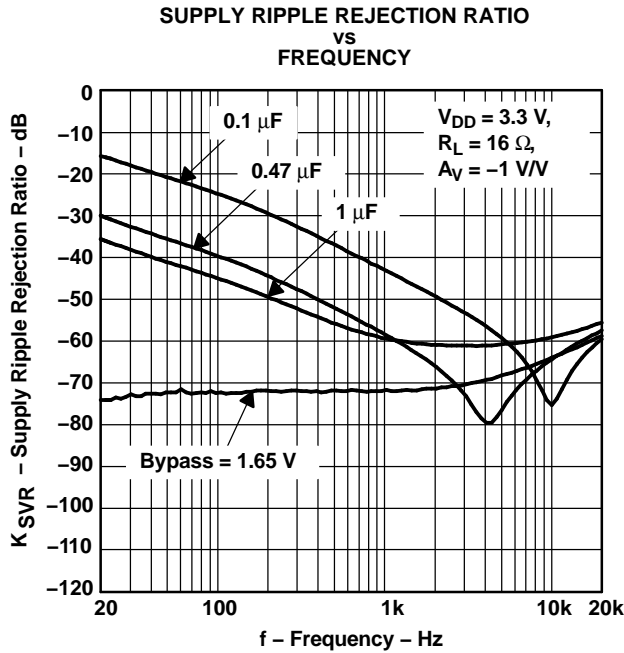

Figure 15.

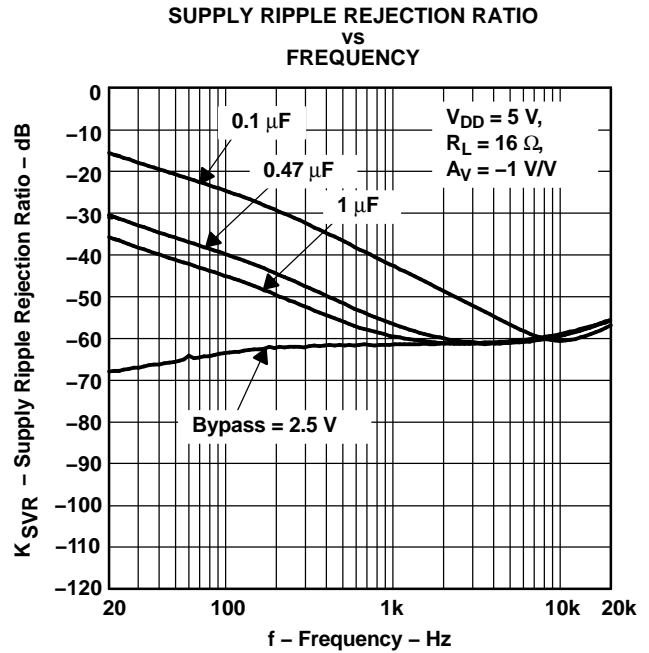

Figure 16.

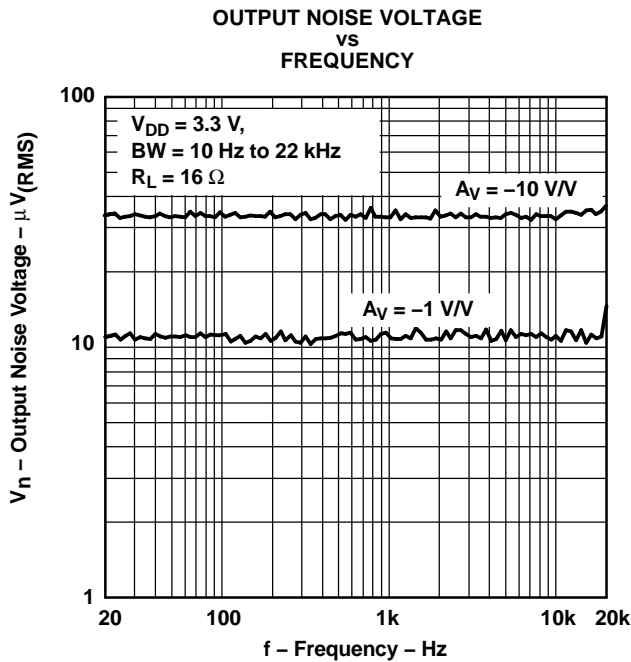

Figure 17.

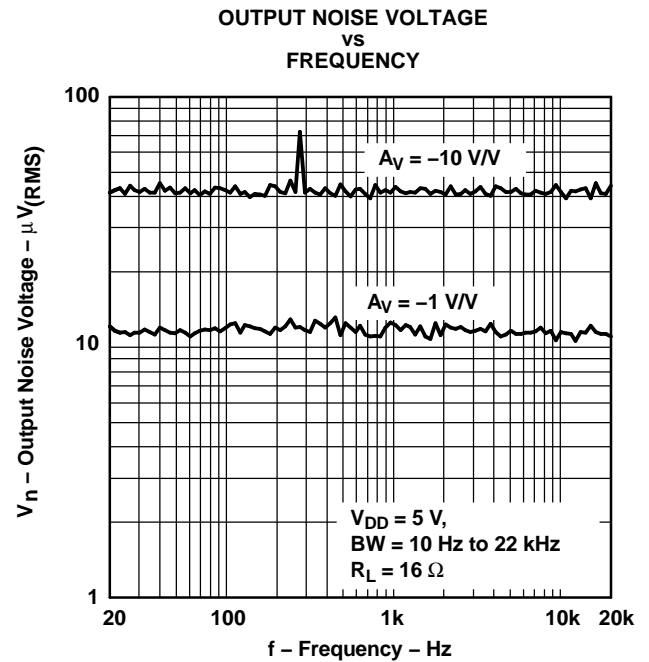

Figure 18.

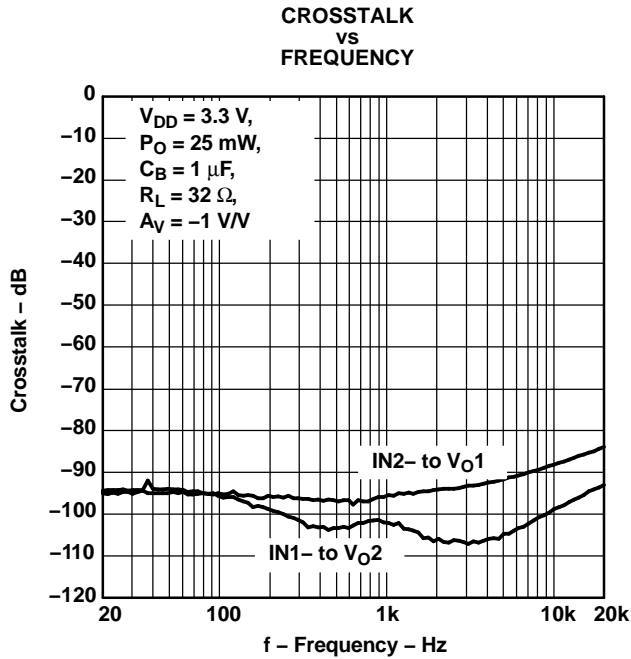

Figure 19.

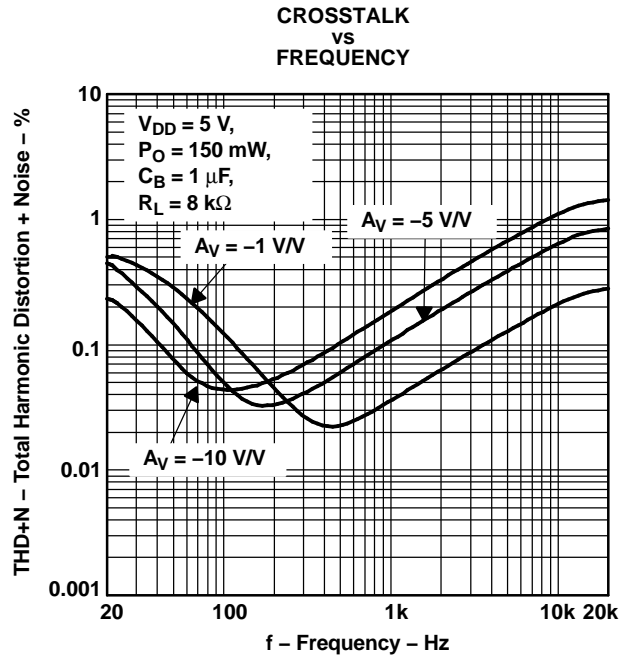

Figure 20.

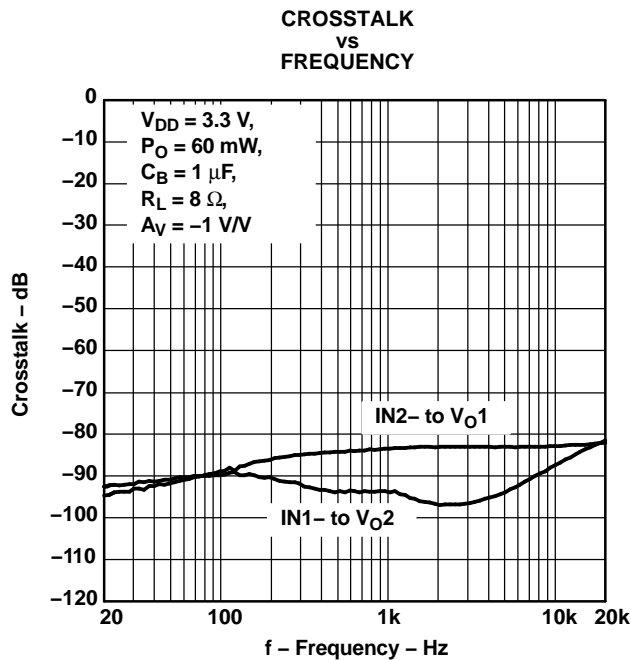

Figure 21.

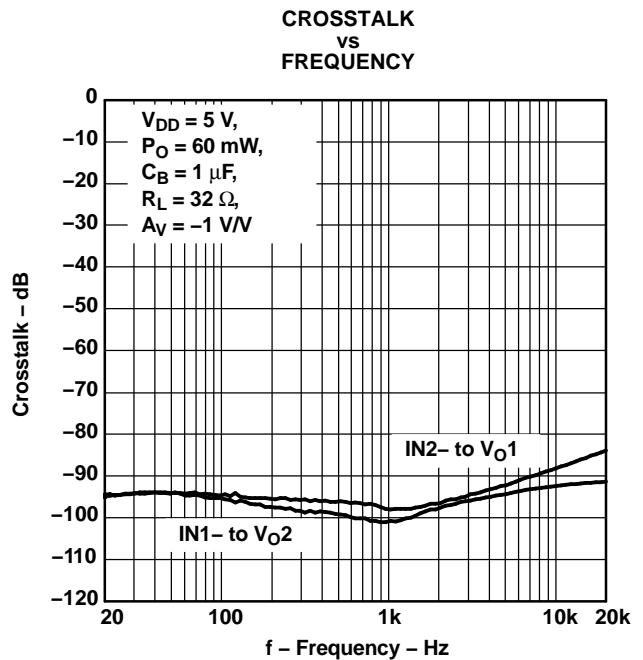

Figure 22.

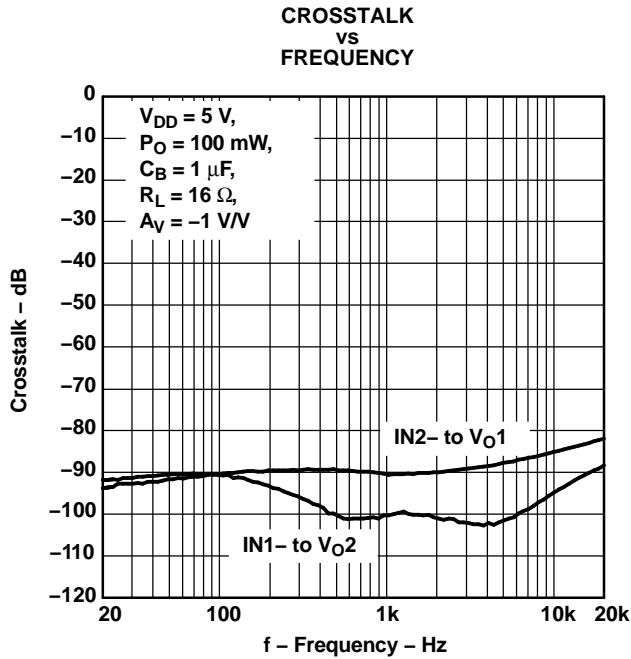

Figure 23.

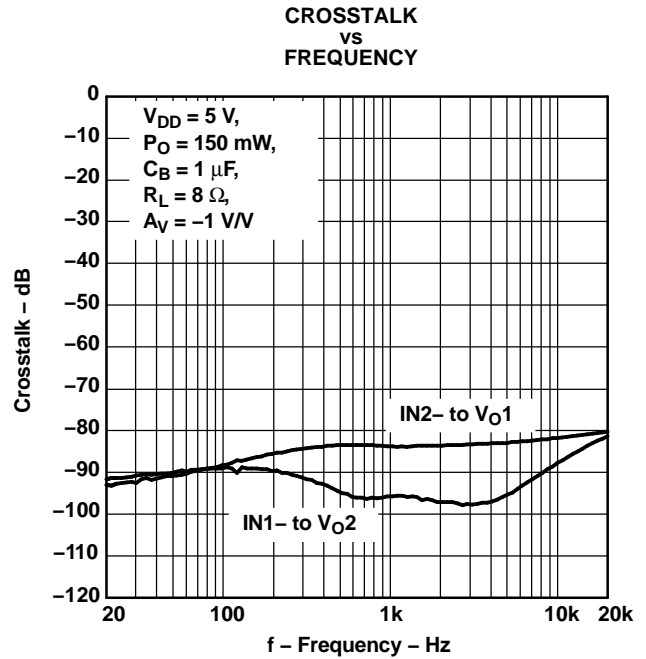

Figure 24.

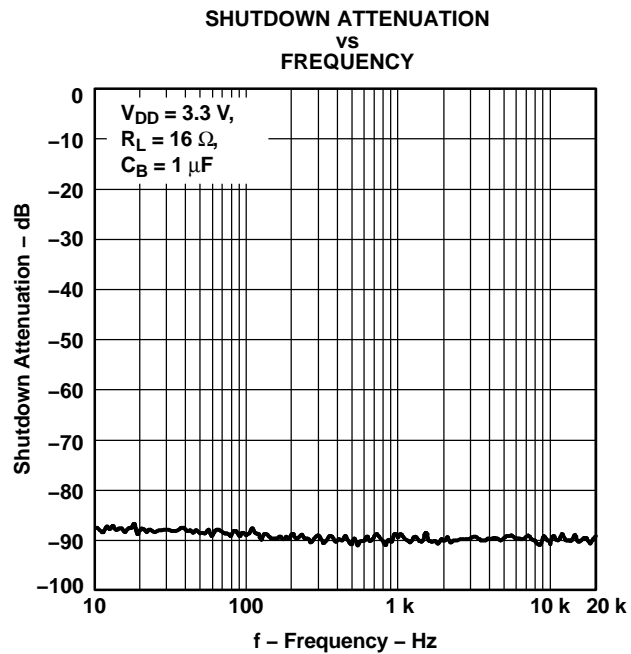

Figure 25.

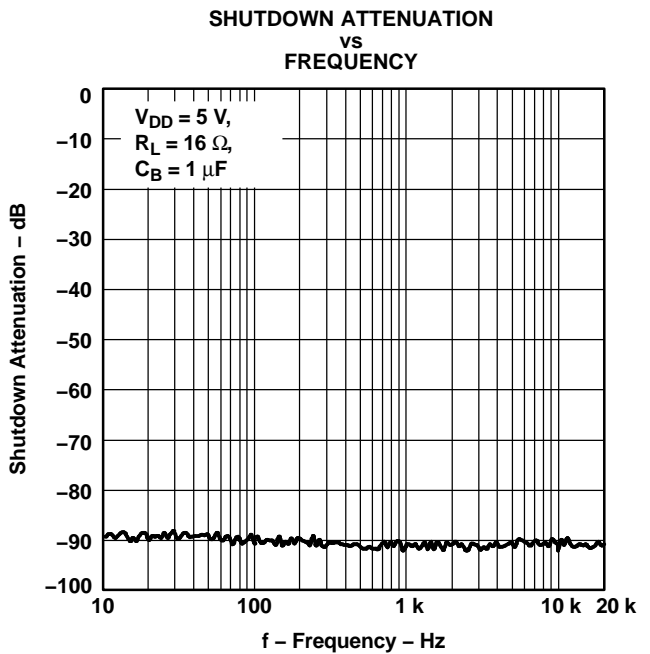

Figure 26.

OPEN-LOOP GAIN AND PHASE MARGIN
VS
FREQUENCY

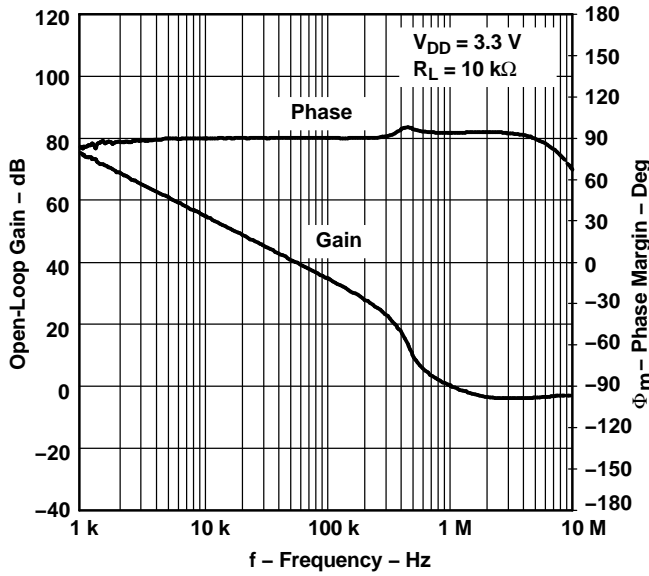

Figure 27.

OPEN-LOOP GAIN AND PHASE MARGIN
VS
FREQUENCY

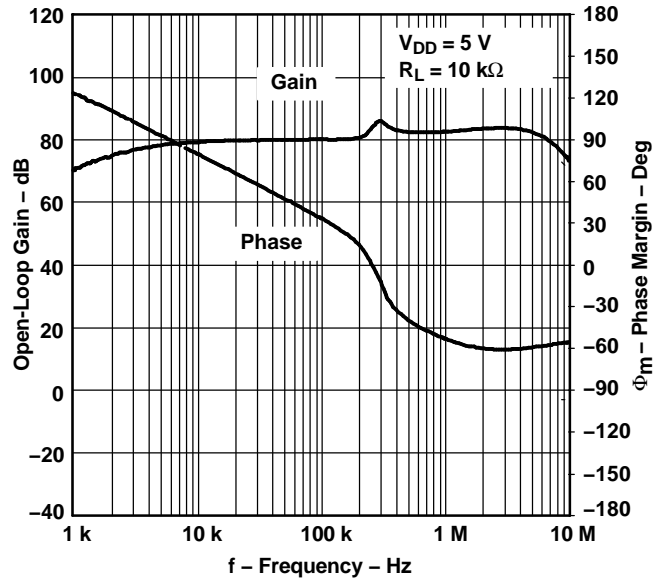

Figure 28.

OUTPUT POWER
VS
LOAD RESISTANCE

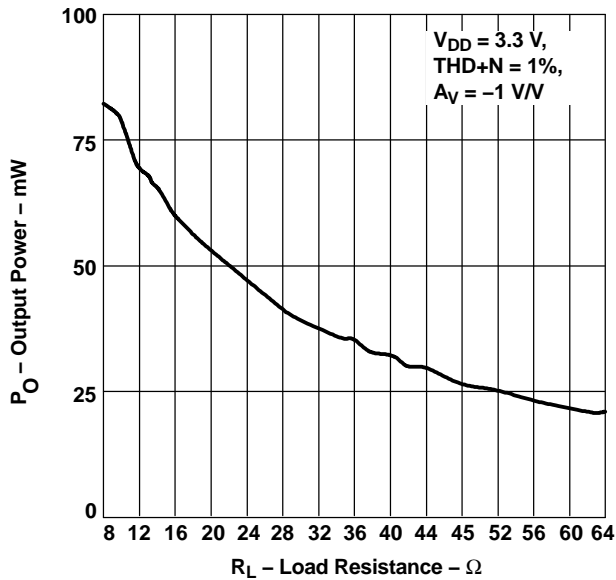

Figure 29.

OUTPUT POWER
VS
LOAD RESISTANCE

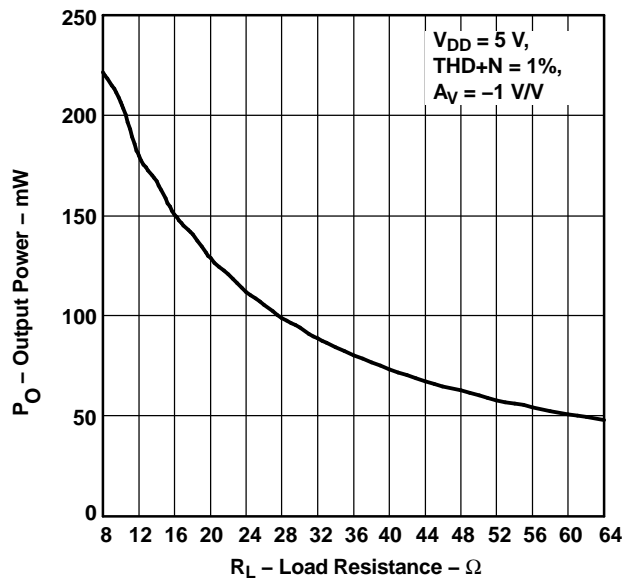

Figure 30.

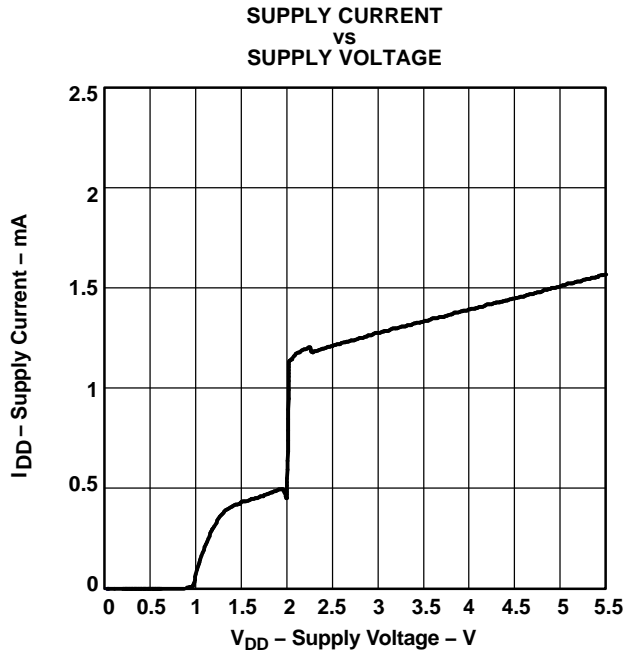

Figure 31.

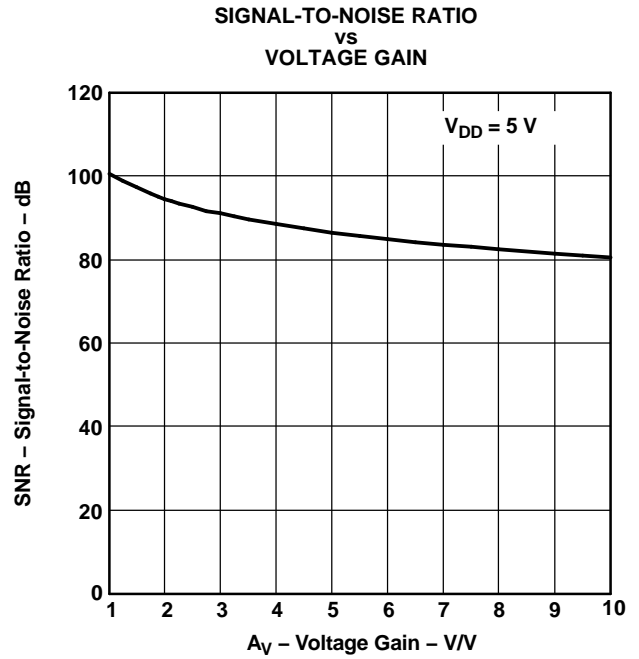

Figure 32.

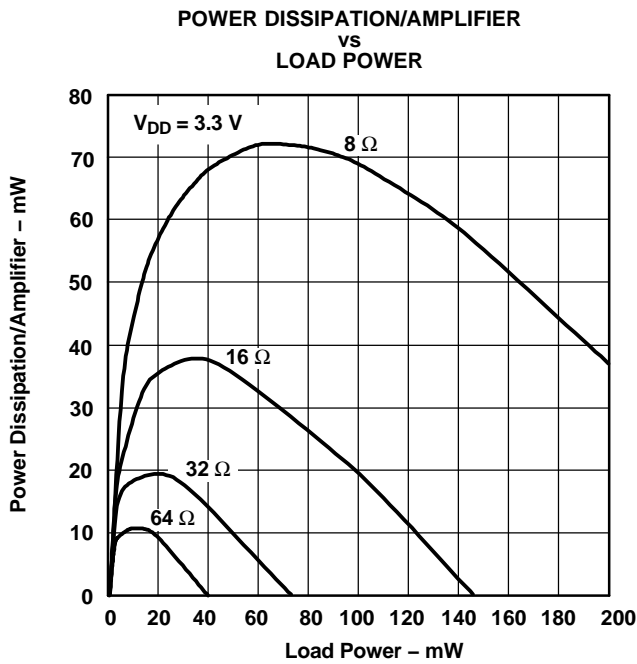

Figure 33.

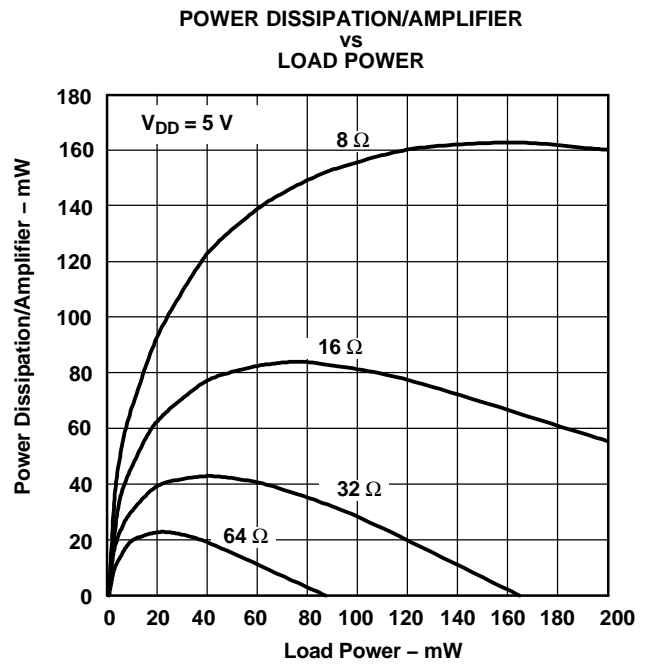

Figure 34.

APPLICATION INFORMATION

GAIN SETTING RESISTORS, R_f and R_i

The gain for the TPA6112A2 is set by resistors R_f and R_i according to Equation 1.

$$\text{Gain} = - \left(\frac{R_f}{R_i} \right) \quad (1)$$

Given that the TPA6112A2 is a MOS amplifier, the input impedance is very high. Consequently input leakage currents are not generally a concern. However, noise in the circuit increases as the value of R_f increases. In addition, a certain range of R_f values is required for proper start-up operation of the amplifier. Considering these factors, it is recommended that the effective impedance seen by the inverting node of the amplifier be set between 5 k Ω and 20 k Ω . The effective impedance is calculated using Equation 2.

$$\text{Effective Impedance} = \frac{R_f R_i}{R_f + R_i} \quad (2)$$

For example, if the input resistance is 20 k Ω and the feedback resistor is 20 k Ω , the gain of the amplifier is -1, and the effective impedance at the inverting terminal is 10 k Ω , a value within the recommended range.

For high performance applications, metal-film resistors are recommended because they tend to have lower noise levels than carbon resistors. For values of R_f above 50 k Ω , the amplifier tends to become unstable due to a pole formed from R_f and the inherent input capacitance of the MOS input structure. For this reason, a small compensation capacitor of approximately 5 pF should be placed in parallel with R_f . This, in effect, creates a low-pass filter network with the cutoff frequency defined by Equation 3.

$$f_{c(\text{lowpass})} = \frac{1}{2\pi R_f C_F} \quad (3)$$

For example, if R_f is 100 k Ω and C_F is 5 pF then $f_{c(\text{lowpass})}$ is 318 kHz, which is well outside the audio range.

INPUT CAPACITOR, C_i

In the typical application, an input capacitor, C_i , is required to allow the amplifier to bias the input signal to the proper dc level for optimum operation. In this case, C_i and R_i form a high-pass filter with the corner frequency determined in Equation 4.

$$f_{c(\text{highpass})} = \frac{1}{2\pi R_i C_i} \quad (4)$$

The value of C_i directly affects the bass (low frequency) performance of the circuit. Consider the example where R_i is 20 k Ω and the specification calls for a flat bass response down to 20 Hz. Equation 4 is reconfigured as Equation 5.

$$C_i = \frac{1}{2\pi R_i f_{c(\text{highpass})}} \quad (5)$$

In this example, C_i is 0.40 μF , so one would likely choose a value in the range of 0.47 μF to 1 μF . A further consideration for this capacitor is the leakage path from the input source through the input network formed by R_i , C_i , and the feedback resistor (R_f) to the load. This leakage current creates a dc offset voltage at the input to the amplifier that reduces useful headroom, especially in high-gain applications (gain >10). For this reason a low-leakage tantalum or ceramic capacitor is the best choice. When polarized capacitors are used, connect the positive side of the capacitor to the amplifier input in most applications. The dc level there is held at $V_{DD}/2$ —likely higher than the source dc level. It is important to confirm the capacitor polarity in the application.

POWER SUPPLY DECOUPLING, $C_{(s)}$

The TPA6112A2 is a high-performance CMOS audio amplifier that requires adequate power-supply decoupling to minimize the output total harmonic distortion (THD). Power-supply decoupling also prevents oscillations when long lead lengths are used between the amplifier and the speaker. The optimum decoupling is achieved by using two capacitors of different types that target different types of noise on the power supply leads. For higher frequency transients, spikes, or digital hash on the line, a good low equivalent-series-resistance (ESR) ceramic capacitor, typically 0.1 μF , placed as close as possible to the device V_{DD} lead, works best. For filtering lower-frequency noise signals, a larger aluminum electrolytic capacitor of 10 μF or greater placed near the power amplifier is recommended.

MIDRAIL BYPASS CAPACITOR, $C_{(B)}$

The midrail bypass capacitor, $C_{(B)}$, serves several important functions. During start up, $C_{(B)}$ determines the rate at which the amplifier starts up. This helps to push the start-up pop noise into the subaudible range (so low it can not be heard). The second function is to reduce noise produced by the power supply caused by coupling into the output drive signal. This noise is from the midrail generation circuit internal to the amplifier. The capacitor is fed from a 230-k Ω source inside the amplifier. To keep the start-up pop as low as possible, maintain the relationship shown in Equation 6.

$$\frac{1}{(C_{(B)} \times 230 \text{ k}\Omega)} \leq \frac{1}{(C_i R_i)} \quad (6)$$

Consider an example circuit where $C_{(B)}$ is 1 μF , C_i is 1 μF , and R_i is 20 k Ω . Substituting these values into the equation 9 results in: $6.25 \leq 50$ which satisfies the rule. Bypass capacitor, $C_{(B)}$, values of 0.1 μF to 1 μF ceramic or tantalum low-ESR capacitors are recommended for the best THD and noise performance.

OUTPUT COUPLING CAPACITOR, $C_{(C)}$

In a typical single-supply, single-ended (SE) configuration, an output coupling capacitor ($C_{(C)}$) is required to block the dc bias at the output of the amplifier, thus preventing dc currents in the load. As with the input coupling capacitor, the output coupling capacitor and impedance of the load form a high-pass filter governed by Equation 7.

$$f_c = \frac{1}{2\pi R_L C_{(C)}} \quad (7)$$

The main disadvantage, from a performance standpoint, is that the typically-small load impedance drives the low-frequency corner higher. Large values of $C_{(C)}$ are required to pass low frequencies into the load. Consider the example where a $C_{(C)}$ of 68 μF is chosen and loads vary from 32 Ω to 47 k Ω . Table 1 summarizes the frequency response characteristics of each configuration.

Table 1. Common Load Impedances vs Low-Frequency Output Characteristics in SE Mode

R_L	$C_{(C)}$	LOWEST FREQUENCY
32 Ω	68 μF	73 Hz
10,000 Ω	68 μF	0.23 Hz
47,000 Ω	68 μF	0.05 Hz

As Table 1 indicates, headphone response is adequate, and drive into line level inputs (a home stereo for example) is very good.

The output coupling capacitor required in single-supply SE mode also places additional constraints on the selection of other components in the amplifier circuit. With the rules described earlier still valid, add the following relationship:

$$\frac{1}{(C_{(B)} \times 230 \text{ k}\Omega)} \leq \frac{1}{(C_i R_i)} \ll \frac{1}{R_L C_{(C)}} \quad (8)$$

USING LOW-ESR CAPACITORS

Low-ESR capacitors are recommended throughout this application. A real capacitor can be modeled simply as a resistor in series with an ideal capacitor. The voltage drop across this resistor minimizes the beneficial effects of the capacitor in the circuit. The lower the equivalent value of this resistance, the more the real capacitor behaves like an ideal capacitor.

5-V VERSUS 3.3-V OPERATION

The TPA6112A2 was designed for operation over a supply range of 2.5 V to 5.5 V. This data sheet provides full specifications for 5-V and 3.3-V operation, since these are considered to be the two most common supply voltages. There are no special considerations for 3.3-V versus 5-V operation as far as supply bypassing, gain setting, or stability. The most important consideration is that of output power. Each amplifier in the TPA6112A2 can produce a maximum voltage swing of $V_{DD} - 1 \text{ V}$. This means, for 3.3-V operation, clipping starts to occur when $V_{O(PP)} = 2.3 \text{ V}$ as opposed when $V_{O(PP)} = 4 \text{ V}$ while operating at 5 V. The reduced voltage swing subsequently reduces maximum output power into the load before distortion becomes significant.

PACKAGING INFORMATION

Orderable Device	Status ⁽¹⁾	Package Type	Package Drawing	Pins	Package Qty	Eco Plan ⁽²⁾	Lead/Ball Finish	MSL Peak Temp ⁽³⁾
TPA6112A2DGQ	ACTIVE	MSOP-Power PAD	DGQ	10	80	Green (RoHS & no Sb/Br)	CU NIPDAU	Level-1-260C-UNLIM
TPA6112A2DGQG4	ACTIVE	MSOP-Power PAD	DGQ	10	80	Green (RoHS & no Sb/Br)	CU NIPDAU	Level-1-260C-UNLIM
TPA6112A2DGQR	ACTIVE	MSOP-Power PAD	DGQ	10	2500	Green (RoHS & no Sb/Br)	CU NIPDAU	Level-1-260C-UNLIM
TPA6112A2DGQRG4	ACTIVE	MSOP-Power PAD	DGQ	10	2500	Green (RoHS & no Sb/Br)	CU NIPDAU	Level-1-260C-UNLIM

⁽¹⁾ The marketing status values are defined as follows:

ACTIVE: Product device recommended for new designs.

LIFEBUY: TI has announced that the device will be discontinued, and a lifetime-buy period is in effect.

NRND: Not recommended for new designs. Device is in production to support existing customers, but TI does not recommend using this part in a new design.

PREVIEW: Device has been announced but is not in production. Samples may or may not be available.

OBSOLETE: TI has discontinued the production of the device.

⁽²⁾ Eco Plan - The planned eco-friendly classification: Pb-Free (RoHS), Pb-Free (RoHS Exempt), or Green (RoHS & no Sb/Br) - please check <http://www.ti.com/productcontent> for the latest availability information and additional product content details.

TBD: The Pb-Free/Green conversion plan has not been defined.

Pb-Free (RoHS): TI's terms "Lead-Free" or "Pb-Free" mean semiconductor products that are compatible with the current RoHS requirements for all 6 substances, including the requirement that lead not exceed 0.1% by weight in homogeneous materials. Where designed to be soldered at high temperatures, TI Pb-Free products are suitable for use in specified lead-free processes.

Pb-Free (RoHS Exempt): This component has a RoHS exemption for either 1) lead-based flip-chip solder bumps used between the die and package, or 2) lead-based die adhesive used between the die and leadframe. The component is otherwise considered Pb-Free (RoHS compatible) as defined above.

Green (RoHS & no Sb/Br): TI defines "Green" to mean Pb-Free (RoHS compatible), and free of Bromine (Br) and Antimony (Sb) based flame retardants (Br or Sb do not exceed 0.1% by weight in homogeneous material)

⁽³⁾ MSL, Peak Temp. -- The Moisture Sensitivity Level rating according to the JEDEC industry standard classifications, and peak solder temperature.

Important Information and Disclaimer:The information provided on this page represents TI's knowledge and belief as of the date that it is provided. TI bases its knowledge and belief on information provided by third parties, and makes no representation or warranty as to the accuracy of such information. Efforts are underway to better integrate information from third parties. TI has taken and continues to take reasonable steps to provide representative and accurate information but may not have conducted destructive testing or chemical analysis on incoming materials and chemicals. TI and TI suppliers consider certain information to be proprietary, and thus CAS numbers and other limited information may not be available for release.

In no event shall TI's liability arising out of such information exceed the total purchase price of the TI part(s) at issue in this document sold by TI to Customer on an annual basis.

TAPE AND REEL INFORMATION
REEL DIMENSIONS

TAPE DIMENSIONS

A0	Dimension designed to accommodate the component width
B0	Dimension designed to accommodate the component length
K0	Dimension designed to accommodate the component thickness
W	Overall width of the carrier tape
P1	Pitch between successive cavity centers

TAPE AND REEL INFORMATION

*All dimensions are nominal

Device	Package Type	Package Drawing	Pins	SPQ	Reel Diameter (mm)	Reel Width W1 (mm)	A0 (mm)	B0 (mm)	K0 (mm)	P1 (mm)	W (mm)	Pin1 Quadrant
TPA6112A2DGQR	MSOP-Power PAD	DGQ	10	2500	330.0	12.4	5.3	3.4	1.4	8.0	12.0	Q1
TPA6112A2DGQR	MSOP-Power PAD	DGQ	10	2500	330.0	12.4	5.3	3.4	1.4	8.0	12.0	Q1

TAPE AND REEL BOX DIMENSIONS

*All dimensions are nominal

Device	Package Type	Package Drawing	Pins	SPQ	Length (mm)	Width (mm)	Height (mm)
TPA6112A2DGQR	MSOP-PowerPAD	DGQ	10	2500	364.0	364.0	27.0
TPA6112A2DGQR	MSOP-PowerPAD	DGQ	10	2500	358.0	335.0	35.0

DGQ (S-PDSO-G10)

PowerPAD™ PLASTIC SMALL OUTLINE

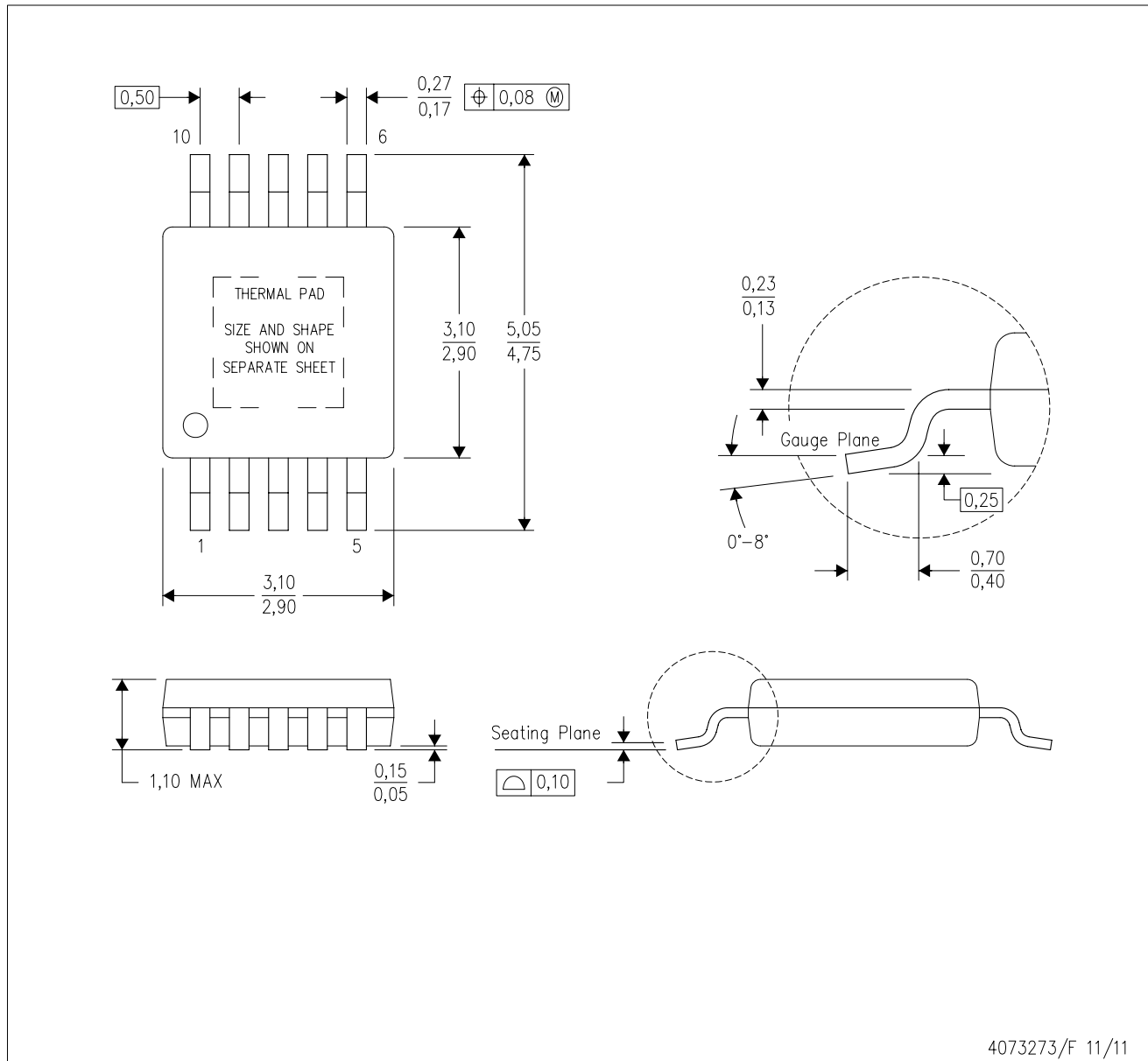

- NOTES:
- A. All linear dimensions are in millimeters.
 - B. This drawing is subject to change without notice.
 - C. Body dimensions do not include mold flash or protrusion not to exceed 0,15.
 - D. This package is designed to be soldered to a thermal pad on the board. Refer to Technical Brief, PowerPad Thermally Enhanced Package, Texas Instruments Literature No. SLMA002 for information regarding recommended board layout. This document is available at www.ti.com <<http://www.ti.com>>.
 - E. See the additional figure in the Product Data Sheet for details regarding the exposed thermal pad features and dimensions.
 - F. Falls within JEDEC MO-187 variation BA-T.

PowerPAD is a trademark of Texas Instruments.

THERMAL PAD MECHANICAL DATA

DGQ (S-PDSO-G10)

PowerPAD™ PLASTIC SMALL OUTLINE

THERMAL INFORMATION

This PowerPAD™ package incorporates an exposed thermal pad that is designed to be attached to a printed circuit board (PCB). The thermal pad must be soldered directly to the PCB. After soldering, the PCB can be used as a heatsink. In addition, through the use of thermal vias, the thermal pad can be attached directly to the appropriate copper plane shown in the electrical schematic for the device, or alternatively, can be attached to a special heatsink structure designed into the PCB. This design optimizes the heat transfer from the integrated circuit (IC).

For additional information on the PowerPAD package and how to take advantage of its heat dissipating abilities, refer to Technical Brief, PowerPAD Thermally Enhanced Package, Texas Instruments Literature No. SLMA002 and Application Brief, PowerPAD Made Easy, Texas Instruments Literature No. SLMA004. Both documents are available at www.ti.com.

The exposed thermal pad dimensions for this package are shown in the following illustration.

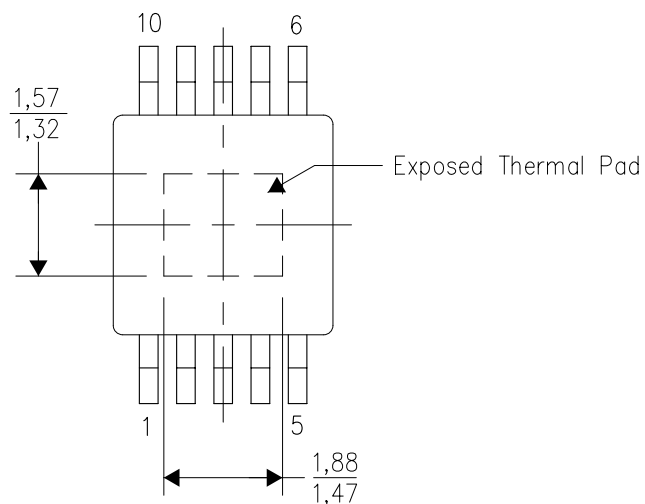

Top View

Exposed Thermal Pad Dimensions

4206324-2/F 01/11

NOTE: A. All linear dimensions are in millimeters

PowerPAD is a trademark of Texas Instruments

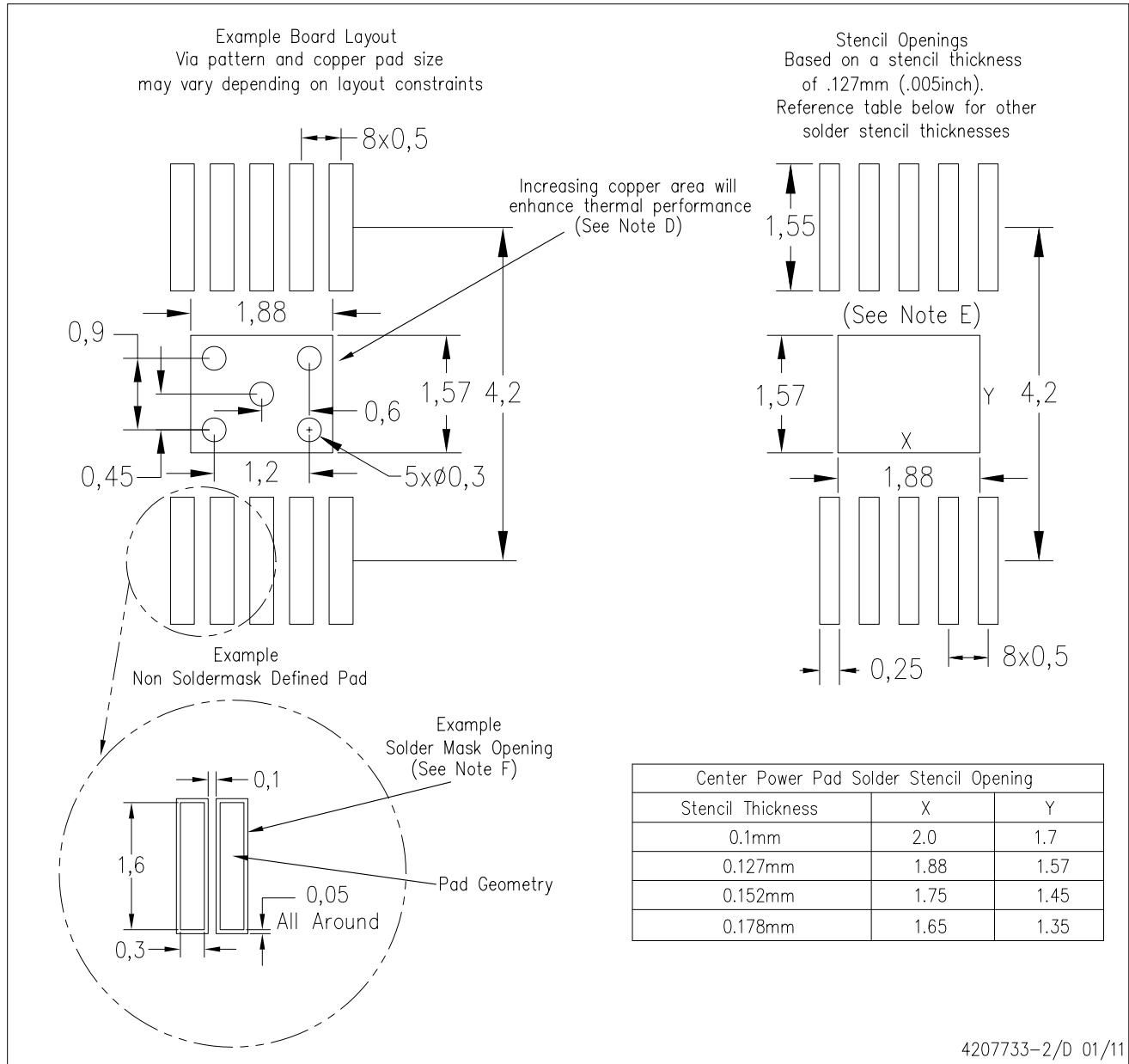

- NOTES:
- All linear dimensions are in millimeters.
 - This drawing is subject to change without notice.
 - Customers should place a note on the circuit board fabrication drawing not to alter the center solder mask defined pad.
 - This package is designed to be soldered to a thermal pad on the board. Refer to Technical Brief, PowerPad Thermally Enhanced Package, Texas Instruments Literature No. SLMA002, SLMA004, and also the Product Data Sheets for specific thermal information, via requirements, and recommended board layout. These documents are available at www.ti.com <<http://www.ti.com>>. Publication IPC-7351 is recommended for alternate designs.
 - Laser cutting apertures with trapezoidal walls and also rounding corners will offer better paste release. Customers should contact their board assembly site for stencil design recommendations. Example stencil design based on a 50% volumetric metal load solder paste. Refer to IPC-7525 for other stencil recommendations.
 - Customers should contact their board fabrication site for solder mask tolerances between and around signal pads.

PowerPAD is a trademark of Texas Instruments

IMPORTANT NOTICE

Texas Instruments Incorporated and its subsidiaries (TI) reserve the right to make corrections, modifications, enhancements, improvements, and other changes to its products and services at any time and to discontinue any product or service without notice. Customers should obtain the latest relevant information before placing orders and should verify that such information is current and complete. All products are sold subject to TI's terms and conditions of sale supplied at the time of order acknowledgment.

TI warrants performance of its hardware products to the specifications applicable at the time of sale in accordance with TI's standard warranty. Testing and other quality control techniques are used to the extent TI deems necessary to support this warranty. Except where mandated by government requirements, testing of all parameters of each product is not necessarily performed.

TI assumes no liability for applications assistance or customer product design. Customers are responsible for their products and applications using TI components. To minimize the risks associated with customer products and applications, customers should provide adequate design and operating safeguards.

TI does not warrant or represent that any license, either express or implied, is granted under any TI patent right, copyright, mask work right, or other TI intellectual property right relating to any combination, machine, or process in which TI products or services are used. Information published by TI regarding third-party products or services does not constitute a license from TI to use such products or services or a warranty or endorsement thereof. Use of such information may require a license from a third party under the patents or other intellectual property of the third party, or a license from TI under the patents or other intellectual property of TI.

Reproduction of TI information in TI data books or data sheets is permissible only if reproduction is without alteration and is accompanied by all associated warranties, conditions, limitations, and notices. Reproduction of this information with alteration is an unfair and deceptive business practice. TI is not responsible or liable for such altered documentation. Information of third parties may be subject to additional restrictions.

Resale of TI products or services with statements different from or beyond the parameters stated by TI for that product or service voids all express and any implied warranties for the associated TI product or service and is an unfair and deceptive business practice. TI is not responsible or liable for any such statements.

TI products are not authorized for use in safety-critical applications (such as life support) where a failure of the TI product would reasonably be expected to cause severe personal injury or death, unless officers of the parties have executed an agreement specifically governing such use. Buyers represent that they have all necessary expertise in the safety and regulatory ramifications of their applications, and acknowledge and agree that they are solely responsible for all legal, regulatory and safety-related requirements concerning their products and any use of TI products in such safety-critical applications, notwithstanding any applications-related information or support that may be provided by TI. Further, Buyers must fully indemnify TI and its representatives against any damages arising out of the use of TI products in such safety-critical applications.

TI products are neither designed nor intended for use in military/aerospace applications or environments unless the TI products are specifically designated by TI as military-grade or "enhanced plastic." Only products designated by TI as military-grade meet military specifications. Buyers acknowledge and agree that any such use of TI products which TI has not designated as military-grade is solely at the Buyer's risk, and that they are solely responsible for compliance with all legal and regulatory requirements in connection with such use.

TI products are neither designed nor intended for use in automotive applications or environments unless the specific TI products are designated by TI as compliant with ISO/TS 16949 requirements. Buyers acknowledge and agree that, if they use any non-designated products in automotive applications, TI will not be responsible for any failure to meet such requirements.

Following are URLs where you can obtain information on other Texas Instruments products and application solutions:

Products

Audio	www.ti.com/audio
Amplifiers	amplifier.ti.com
Data Converters	dataconverter.ti.com
DLP® Products	www.dlp.com
DSP	dsp.ti.com
Clocks and Timers	www.ti.com/clocks
Interface	interface.ti.com
Logic	logic.ti.com
Power Mgmt	power.ti.com
Microcontrollers	microcontroller.ti.com
RFID	www.ti-rfid.com
OMAP Mobile Processors	www.ti.com/omap
Wireless Connectivity	www.ti.com/wirelessconnectivity

Applications

Automotive and Transportation	www.ti.com/automotive
Communications and Telecom	www.ti.com/communications
Computers and Peripherals	www.ti.com/computers
Consumer Electronics	www.ti.com/consumer-apps
Energy and Lighting	www.ti.com/energy
Industrial	www.ti.com/industrial
Medical	www.ti.com/medical
Security	www.ti.com/security
Space, Avionics and Defense	www.ti.com/space-avionics-defense
Video and Imaging	www.ti.com/video

TI E2E Community Home Page

e2e.ti.com

Mailing Address: Texas Instruments, Post Office Box 655303, Dallas, Texas 75265
Copyright © 2012, Texas Instruments Incorporated