

TMMH-125-04-L-DV-EP

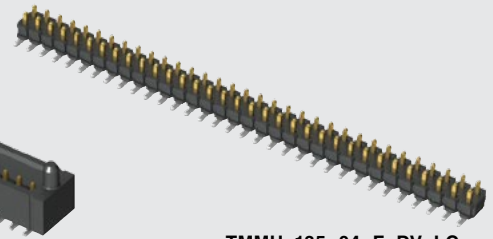

TMMH-135-04-F-DV-LC

(2.00 mm) .0787"

# FLEXIBLE SMT HEADER

## SPECIFICATIONS

For complete specifications and recommended PCB layouts see [www.samtec.com/TMMH](http://www.samtec.com/TMMH)

**Insulator Material:**  
Black Liquid Crystal Polymer  
**Terminal Material:**  
Phosphor Bronze  
**Plating:**  
Sn or Au over  
50 μ" (1.27 μm) Ni  
**Current Rating (TMMH/ESQT):**  
4.5 A per pin  
(2 pins powered)  
**Current Rating (TMMH/SQT):**  
5.1 A per pin  
(2 pins powered)  
**Operating Temp Range:**  
-55 °C to +105 °C with Tin;  
-55 °C to +125 °C with Gold  
**Voltage Rating:**  
281 VAC mated with SQW;  
250 VAC mated with SQT  
**RoHS Compliant:**  
Yes

**Board Mates:**  
CLT, SQT, SQW, ESQT,  
TLE, SMM, MMS

**Cable Mates:**  
TCSD

## FLEX SHROUD

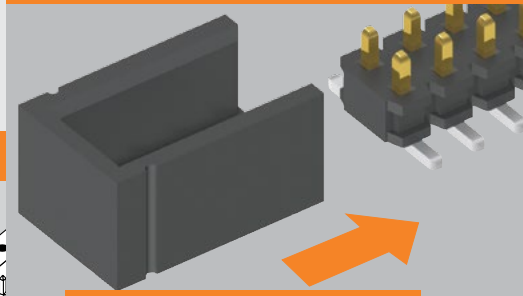

## OTHER SOLUTIONS

Through-hole

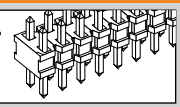

**2 mm Shunt**

Specify 2SN-BK-G for 2 mm shunt with Gold plating.

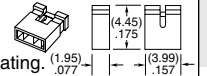

## PROCESSING

**Lead-Free Solderable:**  
Yes  
**SMT Lead Coplanarity:**  
(0.10 mm) .004" max

## RECOGNITIONS

For complete scope of recognitions see [www.samtec.com/quality](http://www.samtec.com/quality)



FILE NO. E111594

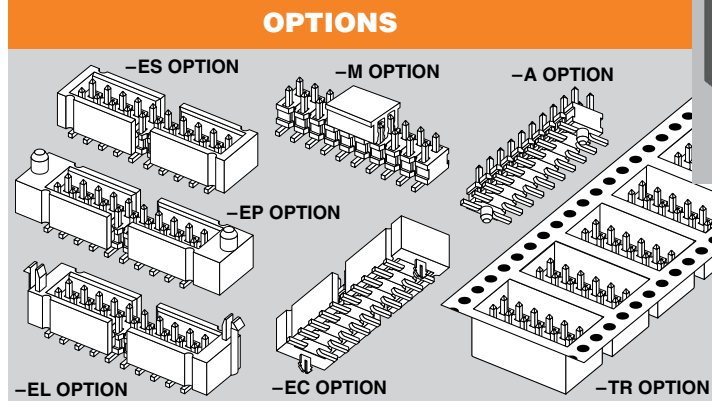

TMMH

1

NO. PINS PER ROW

LEAD STYLE

PLATING OPTION

03 thru 50

Specify LEAD STYLE from chart

-F = Gold flash on post, Matte Tin on tail

-L = 10 μ" (0.25 μm) Gold on post, Matte Tin on tail

-T = Matte Tin

OPTION	Z
-ES	(2.92) .115
-EC	(4.70) .185
-EP & -EPC	(6.10) .240
-EL & -EBC	(4.45) .175

LEAD STYLE	A	MATES WITH
-01	(3.20) .126	SQT, SQW, ESQT, TLE, SMM, MMS, TCSD
-04	(1.91) .075	CLT
-05	(1.65) .065	

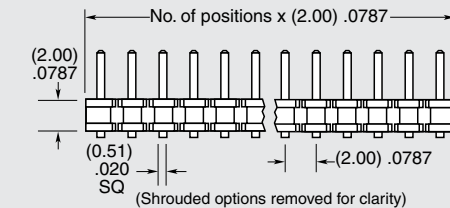
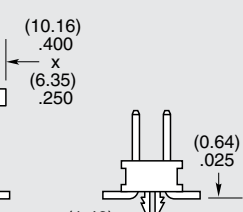
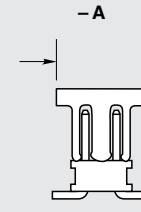
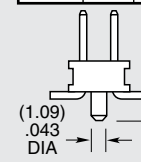
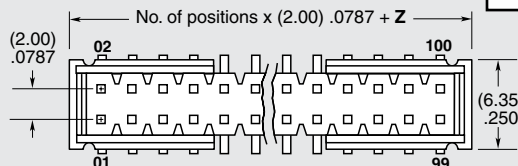

## ALSO AVAILABLE (MOQ Required)

- Other platings
- Contact Samtec.

**Note:**  
Some lengths, styles and options are non-standard, non-returnable.

Due to technical progress, all designs, specifications and components are subject to change without notice.

[WWW.SAMTEC.COM](http://WWW.SAMTEC.COM)

All parts within this catalog are built to Samtec's specifications. Customer specific requirements must be approved by Samtec and identified in a Samtec customer-specific drawing to apply.

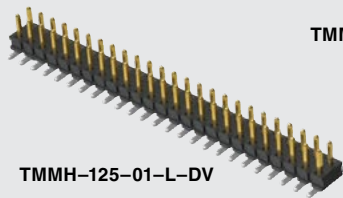

TMMH-125-01-L-DV

TMMH-110-01-F-DV-A

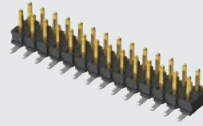
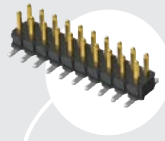

TMMH-114-04-L-DV

TMMH-118-04-F-DV-EL

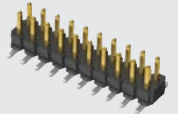

TMMH-110-01-F-DV

**TMMH SERIES**

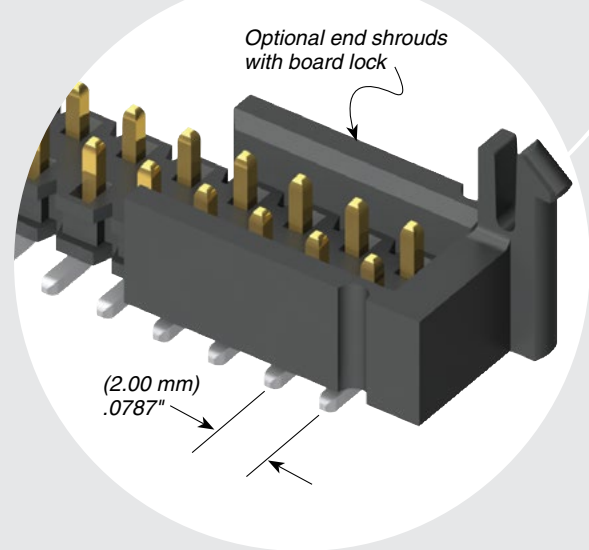
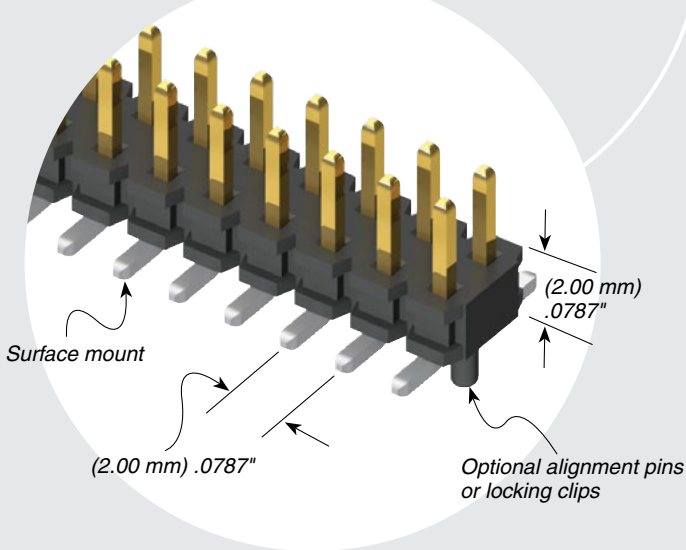

**DV**

**FLEX SHROUD OPTIONS**

**OTHER OPTIONS**

All Flex Shroud options require 9 pins/row minimum (For board-to-board interfaces. Will not mate with TCSD)

**-ES**

= End Shroud  
(For best cost also see TSH Series)

**-EC**

= End Shroud with Locking Clip  
(For best cost also see TSH Series)  
(Manual placement required)

**-EP**

= End Shroud with Guide Post

**-EL**

= End Shroud with Board Lock  
(Boards are positively locked and cannot be unmated)

**-EBC**

= End Shroud with Board Lock and Locking Clip  
(Boards are positively locked and cannot be unmated)

**-EPC**

= End Shroud with Guide Post and Locking Clip  
(Manual placement required)

**-“XXX”**  
= Polarized Position. Specify position of omitted pin

**-A**

= Alignment Pin  
(3 positions minimum)  
(Not available with -LC)

**-LC**

= Locking Clip  
(5 positions minimum)  
(Not available with -A)  
(Manual placement required)

**-M**

= Pick & Place Pad  
(5 positions minimum)

**-TR**

= Tape & Reel Packaging  
(36 positions maximum)  
(Flex Shroud options not available except -ES, -EP & -EL)

LEAD STYLE	X	Y
-01	(5.84) .230	(4.45) .175
-04 & -05	(4.50) .177	(3.02) .119

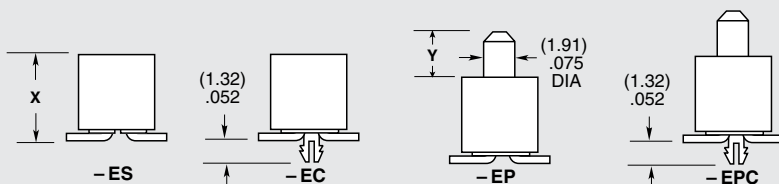
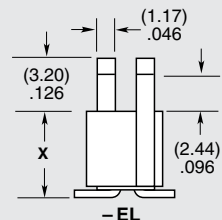
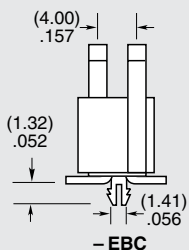

Due to technical progress, all designs, specifications and components are subject to change without notice.

[WWW.SAMTEC.COM](http://WWW.SAMTEC.COM)

All parts within this catalog are built to Samtec's specifications.  
Customer specific requirements must be approved by Samtec and identified in a Samtec customer-specific drawing to apply.