



### Main

Range of product	Modicon M221
Product or component type	Logic controller
[Us] rated supply voltage	100...240 V AC
Discrete input number	9 discrete input conforming to IEC 61131-2 Type 1 including 4 fast input
Analogue input number	2 at input range: 0...10 V
Discrete output type	Relay normally open
Discrete output number	7 relay
Discrete output voltage	5...250 V AC 5...125 V DC
Discrete output current	2 A

### Complementary

Discrete I/O number	16
Number of I/O expansion module	<= 4 with <= 24 discrete output(s) for relay output <= 4 with <= 104 discrete output(s) for transistor output
Supply voltage limits	85...264 V
Network frequency	50/60 Hz
Inrush current	<= 40 A
Power consumption in VA	<= 49 VA at 100...240 V
Discrete input logic	Sink or source (positive/negative)
Discrete input voltage	24 V
Discrete input voltage type	DC
Analogue input resolution	10 bits
LSB value	10 mV
Conversion time	1 ms per channel + 1 controller cycle time for analog input
Permitted overload on inputs	+/- 15 V DC for analog input permanent +/- 30 V DC for analog input with 5 min maximum
Voltage state1 guaranteed	>= 15 V for input
Current state 1 guaranteed	>= 2.5 mA for input
Voltage state 0 guaranteed	<= 5 V for input
Current state 0 guaranteed	<= 1 mA for input
Discrete input current	7 mA for input
Input impedance	100 kOhm for analog input 3.4 kOhm for discrete input
Response time	10 ms turn-off operation for output 10 ms turn-on operation for output 5 µs turn-off operation for fast input 5 µs turn-on operation for fast input 100 µs turn-off operation for input; I8...I15 terminal 100 µs turn-on operation for input; I8...I15 terminal 35 µs turn-off operation for input; I2...I5 terminal 35 µs turn-on operation for input; I2...I5 terminal
Configurable filtering time	12 ms for input 3 ms for input 0 ms for input
Output voltage limits	277 V AC 125 V DC
Current per output common	6 A at COM 1 terminal 8 A at COM 0 terminal
Absolute accuracy error	+/- 1 % of full scale for analog input

The information provided in this documentation contains general descriptions and/or technical characteristics of the performance of the products contained herein. This documentation is not intended as a substitute for and is not to be used for determining suitability or reliability of these products for specific user applications. It is the duty of any such user or integrator to perform the appropriate and complete risk analysis, evaluation and testing of the products with respect to the relevant specific application or use thereof. Neither Schneider Electric Industries SAS nor any of its affiliates or subsidiaries shall be responsible or liable for misuse of the information contained herein.

Electrical durability	<p>Inductive (L/R = 7 ms) DC-13, 24 V/ 7.2 W : 300000 cycles</p> <p>Inductive (L/R = 7 ms) DC-13, 24 V/ 24 W : 100000 cycles</p> <p>Resistive DC-12, 24 V/ 16 W : 300000 cycles</p> <p>Resistive DC-12, 24 V / 48 W : 100000 cycles</p> <p>Inductive AC-14, (cos phi = 0.7) 240 V/ 72 VA : 300000 cycles</p> <p>Inductive AC-14, (cos phi = 0.7) 120 V/ 36 VA : 300000 cycles</p> <p>Inductive AC-14, (cos phi = 0.7) 240 V/ 240 VA : 100000 cycles</p> <p>Inductive AC-14, (cos phi = 0.7) 120 V/ 120 VA : 100000 cycles</p> <p>Inductive AC-15, (cos phi = 0.35) 240 V / 36 VA : 300000 cycles</p> <p>Inductive AC-15, (cos phi = 0.35) 120 V/ 18 VA : 300000 cycles</p> <p>Inductive AC-15, (cos phi = 0.35) 240 V / 120 VA : 100000 cycles</p> <p>Inductive AC-15, (cos phi = 0.35) 120 V/ 60 VA : 100000 cycles</p> <p>Resistive AC-12, 240 V/ 160 VA : 300000 cycles</p> <p>Resistive AC-12, 120 V / 80 VA : 300000 cycles</p> <p>Resistive AC-12, 240 V/ 480 VA : 100000 cycles</p> <p>Resistive AC-12, 120 V / 240 VA : 100000 cycles</p>
Switching frequency	20 switching operations/minute with maximum load
Mechanical durability	>= 20000000 cycles for relay output
Minimum load	10 mA at 5 V DC for relay output
Reset time	1 s
Memory capacity	256 kB for program with 10000 instructions
Data backed up	256 kB built-in flash memory for backup of programs
Data storage equipment	2 GB SD card optional
Battery type	BR2032 lithium non-rechargeable, battery life: 4 yr
Backup time	1 year at 25 °C by interruption of power supply
Execution time for 1 KInstruction	0.3 ms for event and periodic task
Execution time per instruction	0.2 µs Boolean
Exct time for event task	60 µs response time
Clock drift	<= 30 s/month at 25 °C
Regulation loop	Adjustable PID regulator up to 14 simultaneous loops
Control signal type	<p>Single phase signal at 100 kHz for fast input (HSC mode)</p> <p>Pulse/Direction signal at 100 kHz for fast input (HSC mode)</p> <p>A/B signal at 50 kHz for fast input (HSC mode)</p>
Counting input number	4 fast input (HSC mode) (counting frequency: 100 kHz), counting capacity: 32 bits
Integrated connection type	<p>Ethernet with connector RJ45</p> <p>Non isolated serial link "serial 1" with connector RJ45 and interface RS232/RS485</p> <p>USB port with connector mini B USB 2.0</p>
Supply	Serial serial link supply at 5 V 200 mA
Transmission rate	<p>480 Mbit/s - communication protocol: USB</p> <p>1.2...115.2 kbit/s (115.2 kbit/s by default) for bus length of 3 m - communication protocol: RS232</p> <p>1.2...115.2 kbit/s (115.2 kbit/s by default) for bus length of 15 m - communication protocol: RS485</p>
Communication port protocol	<p>Non isolated serial link : Modbus protocol master/slave - RTU/ASCII or SoMachine-Network</p> <p>USB port : USB protocol - SoMachine-Network</p>
Port Ethernet	10BASE-T/100BASE-TX 1 port with 100 m copper cable
Communication service	<p>DHCP client</p> <p>Modbus TCP server</p> <p>Modbus TCP client</p> <p>Modbus TCP slave device</p>
Local signalling	<p>Ethernet network link yellow for Link (Link Status)</p> <p>Ethernet network activity green for ACT</p> <p>1 LED green for SL</p> <p>1 LED per channel green for I/O state</p> <p>1 LED red for BAT</p> <p>1 LED green for SD card access (SD)</p> <p>1 LED red for module error (ERR)</p> <p>1 LED green for RUN</p> <p>1 LED green for PWR</p>
Electrical connection	<p>Mini B USB 2.0 connector for a programming terminal</p> <p>Connector, 4 terminal(s) for analogue inputs</p> <p>Terminal block, 3 terminal(s) for connecting the 24 V DC power supply</p> <p>Removable screw terminal block for outputs</p> <p>Removable screw terminal block for inputs</p>

Cable length	<= 30 m unshielded cable for output <= 10 m shielded cable for fast input <= 30 m unshielded cable for input
Insulation	Non-insulated between analogue inputs Non-insulated between analogue input and internal logic 500 V AC between output groups 500 V AC between output and internal logic Non-insulated between inputs 500 V AC between fast input and internal logic 500 V AC between input and internal logic
Marking	CE
Sensor power supply	24 V DC at 250 mA supplied by the controller
Mounting support	Plate or panel with fixing kit Top hat type TH35-7.5 rail conforming to IEC 60715 Top hat type TH35-15 rail conforming to IEC 60715
Height	70 mm
Depth	70 mm
Width	95 mm
Product weight	0.346 kg

## Environment

Standards	EN/IEC 61131-2 EN/IEC 61010-2-201
Product certifications	CSA CULus IACS E10 RCM
Resistance to electrostatic discharge	4 kV on contact conforming to EN/IEC 61000-4-2 8 kV in air conforming to EN/IEC 61000-4-2
Resistance to electromagnetic fields	1 V/m ( 2 GHz...3 GHz) conforming to EN/IEC 61000-4-3 3 V/m ( 1.4 GHz...2 GHz) conforming to EN/IEC 61000-4-3 10 V/m ( 80 MHz...1 GHz) conforming to EN/IEC 61000-4-3
Resistance to magnetic fields	30 A/m at 50...60 Hz conforming to EN/IEC 61000-4-8
Resistance to fast transients	1 kV for serial link conforming to EN/IEC 61000-4-4 1 kV for Ethernet line conforming to EN/IEC 61000-4-4 1 kV for I/O conforming to EN/IEC 61000-4-4 2 kV for relay output conforming to EN/IEC 61000-4-4 2 kV for power lines conforming to EN/IEC 61000-4-4
Surge withstand	1 kV for relay output in differential mode conforming to EN/IEC 61000-4-5 1 kV for power lines (AC) in differential mode conforming to EN/IEC 61000-4-5 0.5 kV for power lines (DC) in differential mode conforming to EN/IEC 61000-4-5 1 kV for shielded cable in common mode conforming to EN/IEC 61000-4-5 1 kV for I/O in common mode conforming to EN/IEC 61000-4-5 2 kV for relay output in common mode conforming to EN/IEC 61000-4-5 2 kV for power lines (AC) in common mode conforming to EN/IEC 61000-4-5 1 kV for power lines (DC) in common mode conforming to EN/IEC 61000-4-5
Resistance to conducted disturbances, induced by radio frequency fields	10 Vrms (spot frequency (2, 3, 4, 6.2, 8.2, 12.6, 16.5, 18.8, 22, 25 MHz)) conforming to Marine specification (LR, ABS, DNV, GL) 3 Vrms (0.1...80 MHz) conforming to Marine specification (LR, ABS, DNV, GL) 10 Vrms (0.15...80 MHz) conforming to EN/IEC 61000-4-6
Electromagnetic emission	Radiated emissions conforming to EN/IEC 55011 class A 10 m, 230 MHz...1 GHz : 47 dB $\mu$ V/m QP Radiated emissions conforming to EN/IEC 55011 class A 10 m, 30...230 MHz : 40 dB $\mu$ V/m QP Conducted emissions conforming to EN/IEC 55011 power lines, 1.5...30 MHz : 63 dB $\mu$ V/m QP Conducted emissions conforming to EN/IEC 55011 power lines, 150 kHz...1.5 MHz : 79...63 dB $\mu$ V/m QP Conducted emissions conforming to EN/IEC 55011 power lines, 10...150 kHz : 120...69 dB $\mu$ V/m QP Conducted emissions conforming to EN/IEC 55011 power lines (AC), 0.5...300 MHz : 73 dB $\mu$ V/m QP/60 dB $\mu$ V/m AV Conducted emissions conforming to EN/IEC 55011 power lines (AC), 0.15...0.5 MHz : 79 dB $\mu$ V/m QP/66 dB $\mu$ V/m AV
Immunity to microbreaks	10 ms
Ambient air temperature for operation	-10...35 °C for vertical installation -10...55 °C for horizontal installation
Ambient air temperature for storage	-25...70 °C
Relative humidity	10...95 % without condensation in storage 10...95 % without condensation in operation

IP degree of protection	IP20 with protective cover in place
Pollution degree	<= 2
Operating altitude	0...2000 m
Storage altitude	0...3000 m
Vibration resistance	3 gn (vibration frequency: 8.4...150 Hz) on panel mounting 3.5 mm (vibration frequency: 5...8.4 Hz) on panel mounting 3 gn (vibration frequency: 8.4...150 Hz) on symmetrical rail 3.5 mm (vibration frequency: 5...8.4 Hz) on symmetrical rail
Shock resistance	10 gn (test wave duration:11 ms)

Dimensions

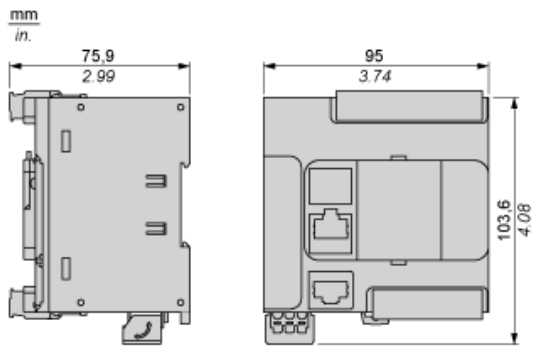

Mounting on a Rail



Direct Mounting on a Panel Surface

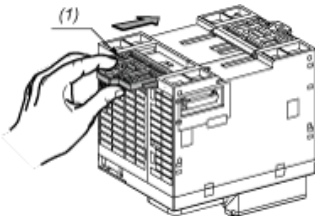

(1) Install a mounting strip

Mounting Hole Layout

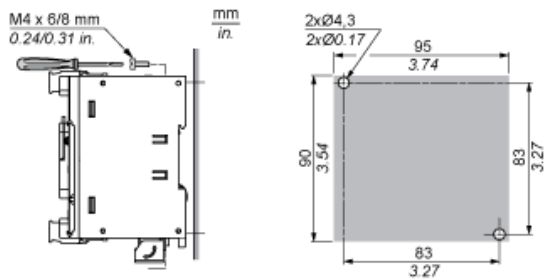

Mounting

Correct Mounting Position



## Acceptable Mounting Position



## Incorrect Mounting Position



## Clearance

mm  
in.

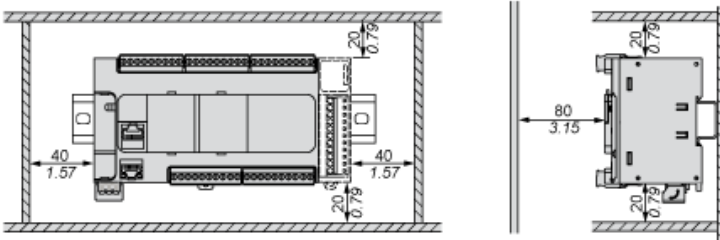

Digital Inputs

Wiring Diagram (Positive Logic)

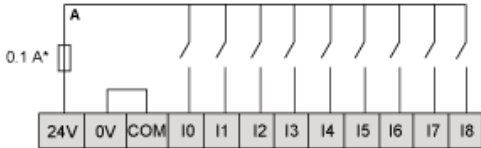

(\*) Type T fuse

Wiring Diagram (Negative Logic)

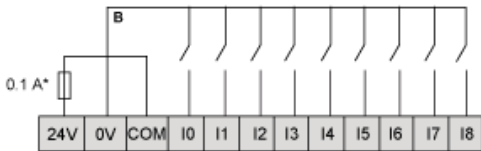

(\*) Type T fuse

Connection of the Fast Inputs

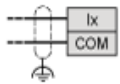

Relay Outputs

Positive Logic (Sink)

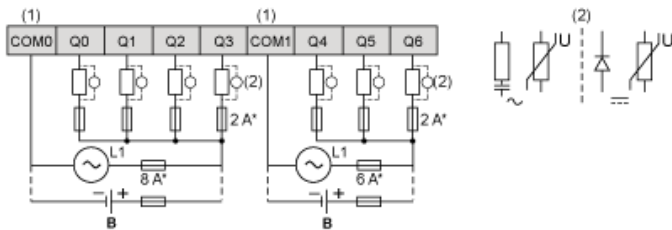

(\*) Type T fuse

(1) The COM1 and COM2 terminals are not connected internally.

(2) To improve the life time of the contacts, and to protect from potential inductive load damage, you must connect a free wheeling diode in parallel to each inductive DC load or an RC snubber in parallel of each inductive AC load

Negative Logic (Source)

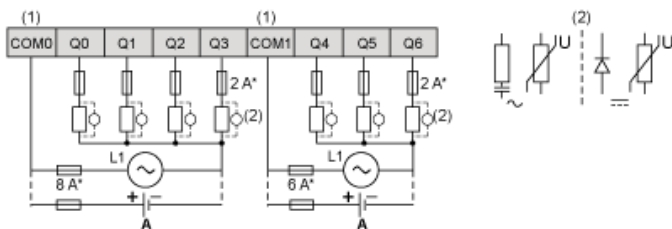

(\*) Type T fuse

(1) The COM1 and COM2 terminals are not connected internally.

(2) To improve the life time of the contacts, and to protect from potential inductive load damage, you must connect a free wheeling diode in parallel to each inductive DC load or an RC snubber in parallel of each inductive AC load

Analog Inputs



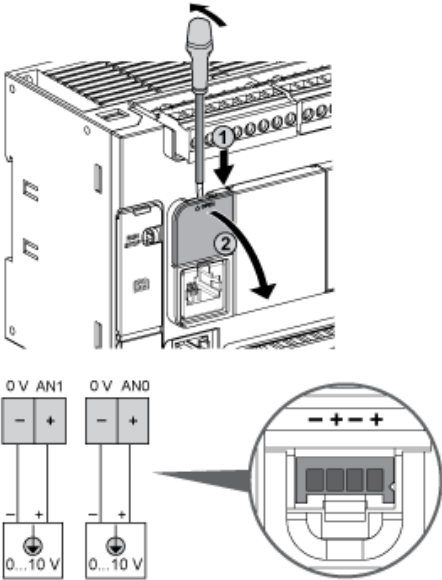

The (-) poles are connected internally.

Pin	Wire Color
0 V	Black
AN1	Red
0 V	Black
AN0	Red

## Ethernet Connection

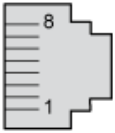

Pin N°	Signal
1	TD+
2	TD-
3	RD+
4	-
5	-
6	RD-
7	-
8	-

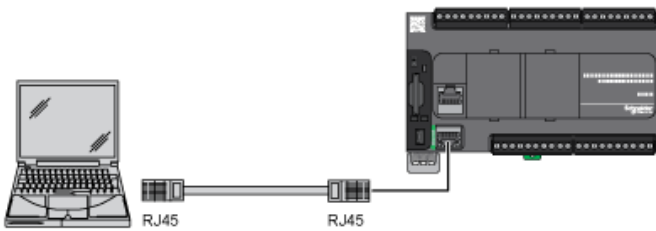

## USB Mini-B Connection

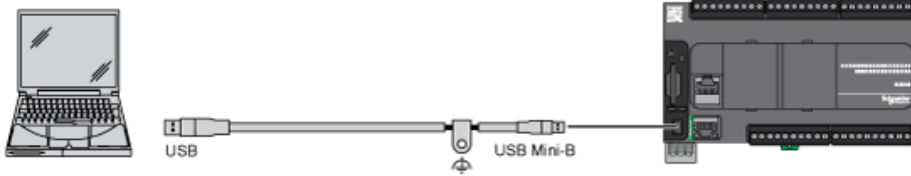

## SL1 Connection

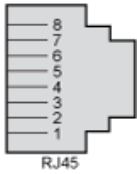

### SL1

N °	RS 232	RS 485
1	RxD	N.C.
2	TxD	N.C.
3	RTS	N.C.
4	N.C.	D1 (A+)
5	N.C.	D0 (B-)
6	CTS	N.C.
7	N.C.	5 Vdc
8	Common	Common

N.C.: not connected

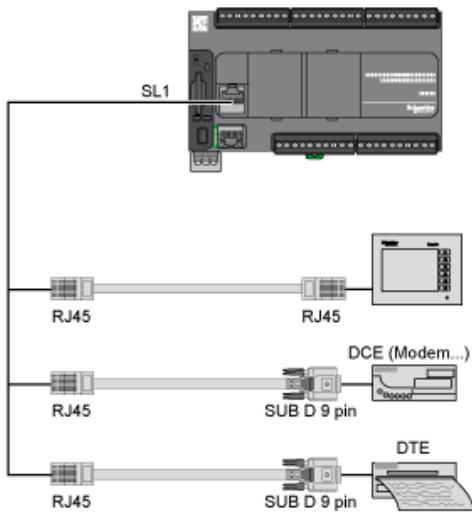

Derating Curves

Embedded Digital Inputs (No Cartridge)

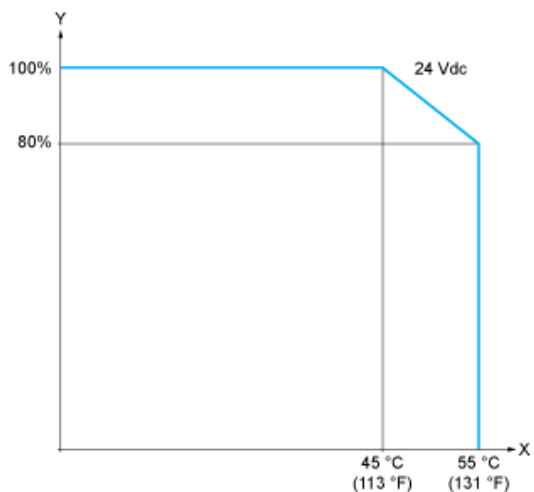

X : Ambient temperature  
Y : Input simultaneous ON ratio

Embedded Digital Inputs (with Cartridge)

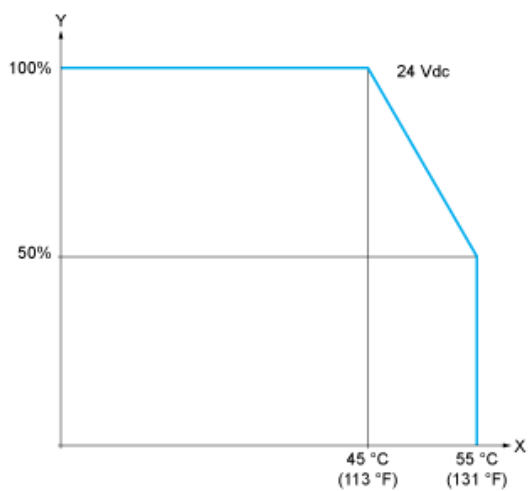

X : Ambient temperature  
Y : Input simultaneous ON ratio