

TLV6208x 1.2-A and 2-A High-Efficiency Step-Down Converter in 2-mm x 2-mm SON Package

1 Features

- DCS-Control™ Architecture for Fast Transient Regulation
- 2.5 to 5.5-V Input Voltage Range (TLV62080)
- 2.7 to 5.5-V Input Voltage Range (TLV62084)
- 100% Duty Cycle for Lowest Dropout
- Power Save Mode for Light Load Efficiency
- Output Discharge Function
- Power Good Output
- Thermal Shutdown
- Available in 2 mm x 2 mm 8-Terminal SON Package
- For Improved Features Set, See the TPS62080 datasheet (SLVSAE8)

2 Applications

- Battery-Powered Portable Devices
- Point-of-Load Regulators
- System Power Rail Voltage Conversion

3 Description

The TLV62080 and TLV62084 devices are low cost buck converters in small size with less external components. They are synchronous step-down converters with an input voltage range of 2.5 and 2.7 (2.5 V for TLV62080, 2.7 V for TLV62084) to 5.5 V. The TLV6208x device focuses on high-efficiency step-down conversion over a wide output current range. At medium to heavy loads, the TLV6208x converter operates in PWM mode and automatically enters power save mode operation at light-load currents to maintain high efficiency over the entire load current range.

To address the requirements of system power rails, the internal compensation circuit allows a large selection of external output capacitor values ranging from 10- μ F up to 100- μ F effective capacitance. With the DCS-Control™ (Direct Control with Seamless transition into power save mode) architecture excellent load transient performance and output voltage regulation accuracy are achieved. The device is available in 2-mm x 2-mm SON package with Thermal Pad.

Device Information

ORDER NUMBER	PACKAGE	BODY SIZE
TLV62080DSGR	WSON (8)	2,00 mm x 2,00 mm
TLV62080DSGT	WSON (8)	2,00 mm x 2,00 mm
TLV62084DSGR	WSON (8)	2,00 mm x 2,00 mm
TLV62084DSGT	WSON (8)	2,00 mm x 2,00 mm

4 Typical Application

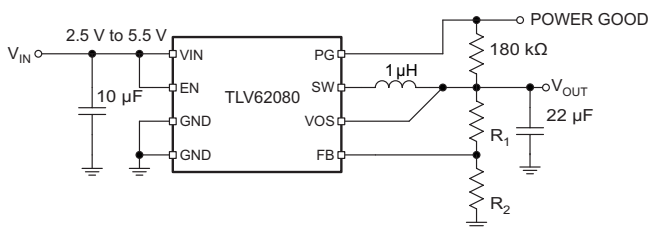

Efficiency vs Load Current
 $V_{OUT} = 1.2 V$

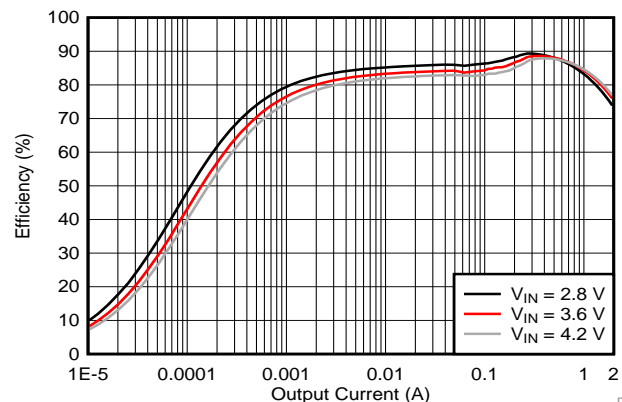

D002



Table of Contents

1 Features	1	8.4 Device Functional Modes	11
2 Applications	1	9 Application and Implementation	11
3 Description	1	9.1 Application Information	11
4 Typical Application	1	9.2 Typical Application	11
5 Revision History	2	10 Power Supply Recommendations	16
6 Terminal Configurations and Functions	4	11 Layout	16
7 Specifications	5	11.1 Layout Guidelines	16
7.1 Absolute Maximum Ratings	5	11.2 Layout Example	16
7.2 Handling Ratings	5	11.3 Thermal Information	17
7.3 Recommended Operating Conditions	5	12 Device and Documentation Support	18
7.4 Thermal Information	5	12.1 Device Support	18
7.5 Electrical Characteristics	6	12.2 Documentation Support	18
7.6 Typical Characteristics	7	12.3 Related Links	18
8 Detailed Description	9	12.4 Trademarks	18
8.1 Overview	9	12.5 Electrostatic Discharge Caution	18
8.2 Functional Block Diagram	9	12.6 Glossary	18
8.3 Feature Description	9	13 Mechanical, Packaging, and Orderable Information	18

5 Revision History

NOTE: Page numbers for previous revisions may differ from page numbers in the current version.

Changes from Revision D (June 2013) to Revision E	Page
• Added the <i>Device Information</i> table, <i>Power Supply Recommendations</i> , <i>Device and Documentation Support</i> , and <i>Mechanical, Packaging, and Orderable Information</i> sections	1
• Clarified the input voltage ranges of 2.5 V to 5.5 V for the TLV62080 device and 2.7 V to 5.5 V for the TLV62084 device	1
• Changed the Ordering Information table to the Device Comparison table and removed the Package Marking, T_A , and Package columns from the table	4
• Changed the word <i>pin</i> to <i>terminal</i> in most cases throughout the document	4
• Added the <i>Handling Ratings</i> table which now contains the storage temperature range and ESD ratings	5
• Added V_{IN} range for TLV62084 to <i>RECOMMENDED OPERATING CONDITIONS</i> table	5
• Added I_{LIM} range for TLV62084 in <i>ELECTRICAL CHARACTERISTICS</i> table	6
• Replaced the <i>Switching Frequency vs Load Current</i> graph to the new <i>Switching Frequency vs Output Current</i> graph in the <i>Typical Characteristics</i> section	7
• Added the higher output voltage <i>Output Voltage vs Load Current</i> graph in the <i>Typical Characteristics</i> section	8
• Replaced the TLV62080 typical application circuit with the circuit for the TLV62084	11
• Deleted the <i>Parameter Measurement Information</i> Section and moved image and list of components to <i>Typical Application</i> section	11
• Added the <i>Design Parameters</i> table in the <i>Design Requirements</i> section	11
• Added Moved Waveforms from the <i>Typical Characteristics</i> section into the <i>Application Curves</i> section. Changed L_{COIL} (coil inductance) to I_{COIL} (coil current) in the <i>Typical Application (PWM Mode and PFM Mode)</i> , <i>Load Transient</i> , <i>Line Transient</i> , and <i>Startup</i> waveforms	14
• Added the output capacitance and inductance conditions to the first (original) <i>Load Transient</i> graph	14
• Added the second <i>Load Transient</i> graph (Figure 14)	14

Changes from Revision C (May 2013) to Revision D	Page
• Deleted TLV62084 device number from datasheet	17

Changes from Revision B (July 2012) to Revision C
Page

- Changed the Thermal Information table values 5

Changes from Revision A (November 2011) to Revision B
Page

- Changed QFN to SON in ORDERING INFORMATION 4
- Changed QFN to SON in DEVICE INFORMATION 4
- Changed Thermal Pad description in PIN FUNCTIONS 4
- Changed T_J in the ABS MAX RATINGS From: -40 to 125°C To: -40 to 150°C 5
- Changed several instances of DSC to DCS in DEVICE OPERATION section 9
- Changed DSC to DCS in [Functional Block Diagram](#) 9

Changes from Original (October 2011) to Revision A
Page

- Changed pin VSNS to VOS in [Typical Application](#) 1
- Changed pin VSNS to VOS in 11
- Changed pin VSNS to VOS in 13

Device Comparison Table

PART NUMBER ⁽¹⁾	INPUT VOLTAGE	OUTPUT CURRENT
TLV62080DSG	2.5 V to 5.5 V	1.2 A
TLV62084DSG	2.7 V to 5.5 V	2 A

(1) For detailed ordering information please check the [Mechanical, Packaging, and Orderable Information](#) section at the end of this datasheet.

6 Terminal Configurations and Functions

8-Terminal SON With Thermal Pad
DSG Package
(Top View)

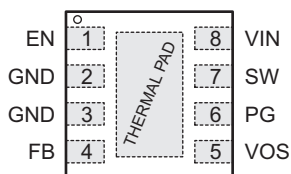

Terminal Functions

TERMINAL		I/O	DESCRIPTION
NAME	NO.		
EN	1	IN	Device enable logic input. Logic HIGH enables the device, logic LOW disables the device and turns it into shutdown.
FB	4	IN	Feedback terminal for the internal control loop. Connect this terminal to the external feedback divider to program the output voltage.
GND	2, 3	PWR	Power and signal ground.
PG	6	OUT	Power Good open drain output. This terminal is pulled to low if the output voltage is below regulation limits. This terminal can be left floating if not used.
SW	7	PWR	Switch terminal connected to the internal MOSFET switches and inductor terminal. Connect the inductor of the output filter here.
VIN	8	PWR	Power supply voltage input.
VOS	5	IN	Output voltage sense terminal for the internal control loop. Must be connected to output.
Thermal Pad	—	—	Must be connected to GND. Must be soldered to achieve appropriate power dissipation and mechanical Thermal Pad reliability.

7 Specifications

7.1 Absolute Maximum Ratings

over operating free-air temperature range (unless otherwise noted)⁽¹⁾

		MIN	MAX	UNIT
Voltage range	V _{IN} , PG, VOS ⁽²⁾	-0.3	7	V
	SW ⁽²⁾⁽³⁾	-0.3	V _{IN} + 0.3	V
	FB ⁽²⁾	-0.3	3.6	V
	EN ⁽²⁾	-0.3	V _{IN} + 0.3	V
Operating junction temperature range, T _J		-40	150	°C

- (1) Stresses beyond those listed under *absolute maximum ratings* may cause permanent damage to the device. These are stress ratings only and functional operation of the device at these or any other conditions beyond those indicated under *recommended operating conditions* is not implied. Exposure to absolute–maximum–rated conditions for extended periods may affect device reliability.
- (2) All voltage values are with respect to network ground terminal.
- (3) During operation, device switching.

7.2 Handling Ratings

		MIN	MAX	UNIT
T _{stg}	Storage temperature range	-65	150	°C
V _{ESD} ⁽¹⁾	Human body model (HBM) ESD stress voltage ⁽²⁾		2	kV
	Charged device model (CDM) ESD stress voltage ⁽³⁾		500	V

- (1) Electrostatic discharge (ESD) to measure device sensitivity and immunity to damage caused by assembly line electrostatic discharges into the device.
- (2) Level listed above is the passing level per ANSI/ESDA/JEDEC JS-001. JEDEC document JEP155 states that 500-V HBM allows safe manufacturing with a standard ESD control process.
- (3) Level listed above is the passing level per EIA-JEDEC JESD22-C101. JEDEC document JEP157 states that 250-V CDM allows safe manufacturing with a standard ESD control process.

7.3 Recommended Operating Conditions⁽¹⁾

		MIN	TYP	MAX	UNIT
V _{IN}	Input voltage range, TLV62080	2.5		5.5	V
V _{IN}	Input voltage range, TLV62084	2.7		5.5	V
T _A	Operating ambient temperature	-40		85	°C
T _J	Operating junction temperature	-40		125	°C

- (1) Refer to the [Application Information](#) section for further information.

7.4 Thermal Information

THERMAL METRIC ⁽¹⁾		TLV6208x DSG (8 TERMINALS)	UNITS
θ _{JA}	Junction-to-ambient thermal resistance	59.7	°C/W
θ _{JCtop}	Junction-to-case (top) thermal resistance	70.1	
θ _{JB}	Junction-to-board thermal resistance	30.9	
ψ _{JT}	Junction-to-top characterization parameter	1.4	
ψ _{JB}	Junction-to-board characterization parameter	31.5	
θ _{JCbot}	Junction-to-case (bottom) thermal resistance	8.6	

- (1) For more information about traditional and new thermal metrics, see the *IC Package Thermal Metrics* application report, [SPRA953](#).

7.5 Electrical Characteristics

Over recommended free-air temperature range, $T_A = -40^\circ\text{C}$ to 85°C , typical values are at $T_A = 25^\circ\text{C}$ (unless otherwise noted), $V_{IN} = 3.6\text{ V}$.

PARAMETER		TEST CONDITIONS	MIN	TYP	MAX	UNIT
SUPPLY						
V_{IN}	Input voltage range, TLV62080		2.5		5.5	V
V_{IN}	Input voltage range, TLV62084		2.7		5.5	V
I_Q	Quiescent current into VIN	$I_{OUT} = 0\text{ mA}$, Device not switching		30		μA
I_{SD}	Shutdown current into VIN	EN = LOW			1	μA
V_{UVLO}	Under voltage lock out	Input voltage falling		1.8	2	V
	Under voltage lock out hysteresis	Rising above V_{UVLO}		120		mV
T_{JSD}	Thermal shut down	Temperature rising		150		$^\circ\text{C}$
	Thermal shutdown hysteresis	Temperature falling below T_{JSD}		20		$^\circ\text{C}$
LOGIC INTERFACE (EN)						
V_{IH}	High level input voltage	$2.5\text{ V} \leq V_{IN} \leq 5.5\text{ V}$	1			V
V_{IL}	Low level input voltage	$2.5\text{ V} \leq V_{IN} \leq 5.5\text{ V}$			0.4	V
I_{LKG}	Input leakage current			0.01	0.5	μA
POWER GOOD						
V_{PG}	Power good threshold	V_{OUT} falling referenced to V_{OUT} nominal	-15	-10	-5	%
	Power good hysteresis			5		%
V_{IL}	Low level voltage	$I_{sink} = 500\ \mu\text{A}$			0.3	V
$I_{PG,LKG}$	PG Leakage current	$V_{PG} = 5.0\text{ V}$		0.01	0.1	μA
OUTPUT						
V_{OUT}	Output voltage range		0.5		4	V
V_{FB}	Feedback regulation voltage	$V_{IN} \geq 2.5\text{ V}$ and $V_{IN} \geq V_{OUT} + 1\text{ V}$	0.438	0.45	0.462	V
I_{FB}	Feedback input bias current	$V_{FB} = 0.45\text{ V}$		10	100	nA
R_{DIS}	Output discharge resistor	EN = LOW, $V_{OUT} = 1.8\text{ V}$		1		k Ω
$R_{DS(on)}$	High side FET on-resistance	$I_{SW} = 500\text{ mA}$		120		m Ω
	Low side FET on-resistance	$I_{SW} = 500\text{ mA}$		90		m Ω
I_{LIM}	High side FET switch current-limit, TLV62080	Rising inductor current	1.6	2.8	4	A
I_{LIM}	High side FET switch current-limit, TLV62084	Rising inductor current	2.3	2.8	4	A

7.6 Typical Characteristics

Table 1. Table of Graphs

		FIGURE
Efficiency	Load current, $V_{OUT} = 0.9\text{ V}$	Figure 1
	Load current, $V_{OUT} = 1.2\text{ V}$	Figure 2
	Load current, $V_{OUT} = 2.5\text{ V}$	Figure 3
Output Voltage Accuracy	Input Voltage, $V_{OUT} = 0.9\text{ V}$	Figure 4
	Input Voltage, $V_{OUT} = 2.5\text{ V}$	Figure 5
	Load current, $V_{OUT} = 0.9\text{ V}$	Figure 6
	Load current, $V_{OUT} = 2.5\text{ V}$	Figure 7
Switching Frequency	Load current, $V_{OUT} = 2.5\text{ V}$	Figure 8

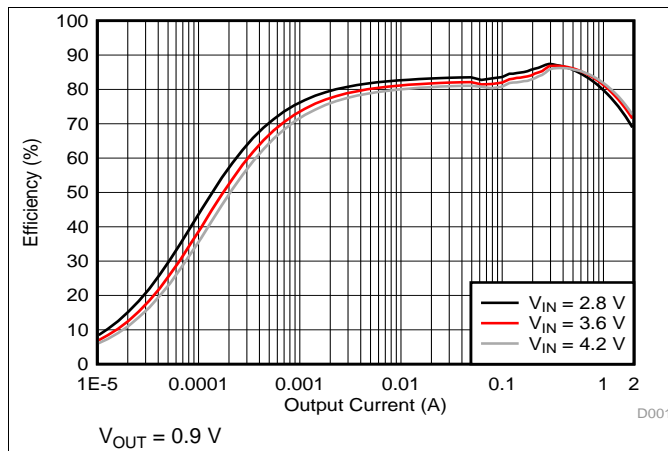

Figure 1. Efficiency vs Load Current

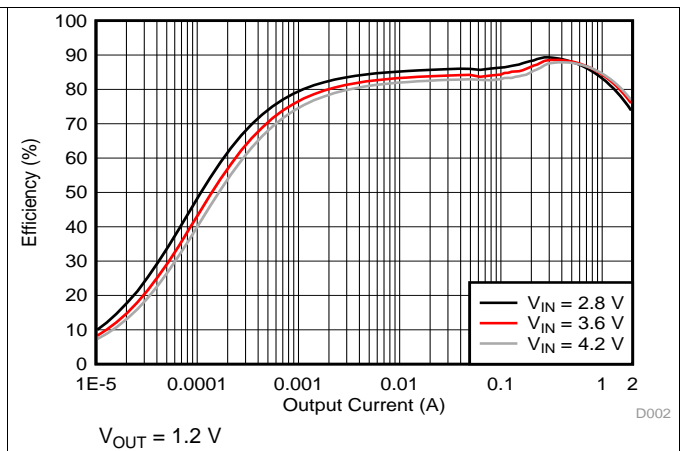

Figure 2. Efficiency vs Load Current

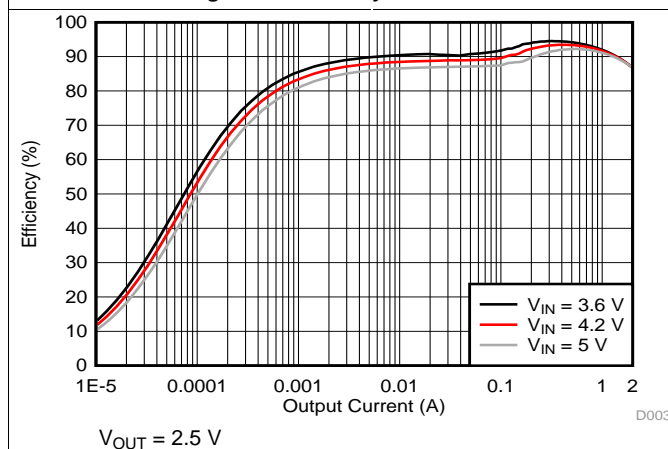

Figure 3. Efficiency vs Load Current

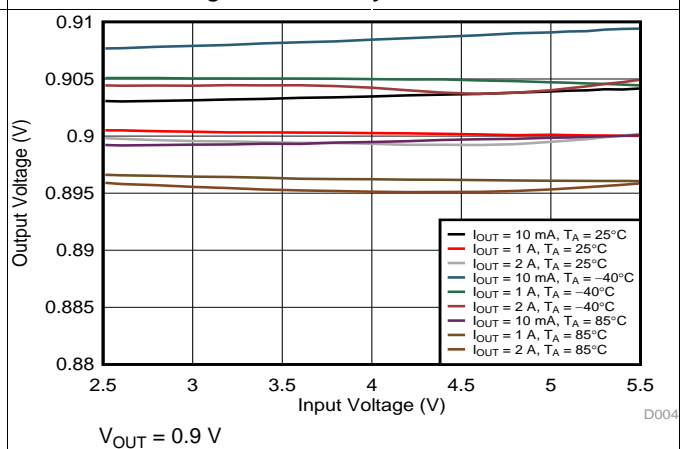

Figure 4. Output Voltage vs Input Voltage

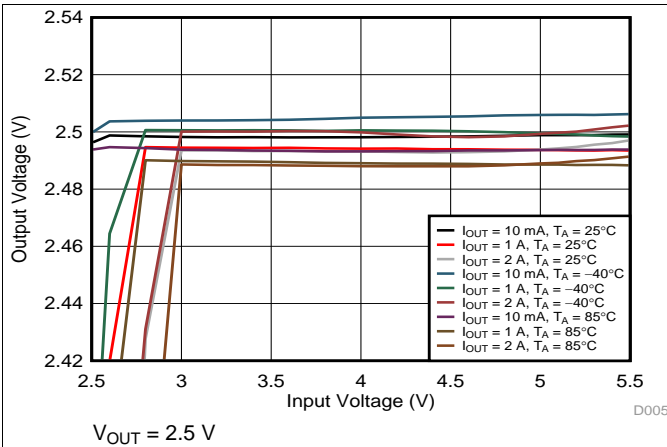

Figure 5. Output Voltage vs Input Voltage

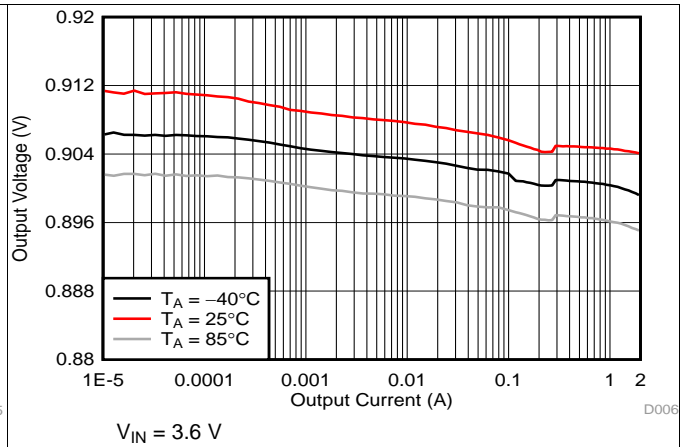

Figure 6. Output Voltage vs Load Current

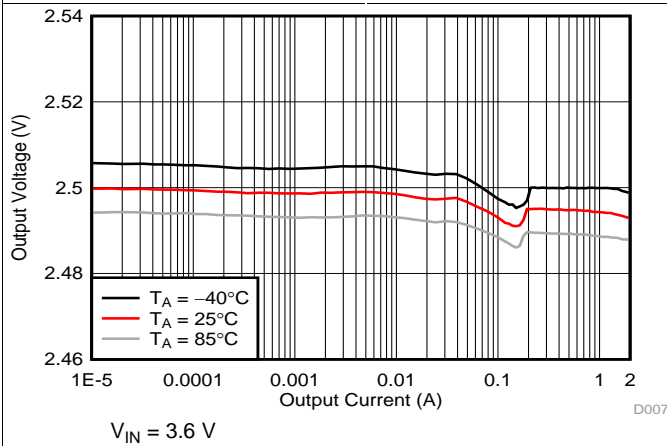

Figure 7. Output Voltage vs Load Current

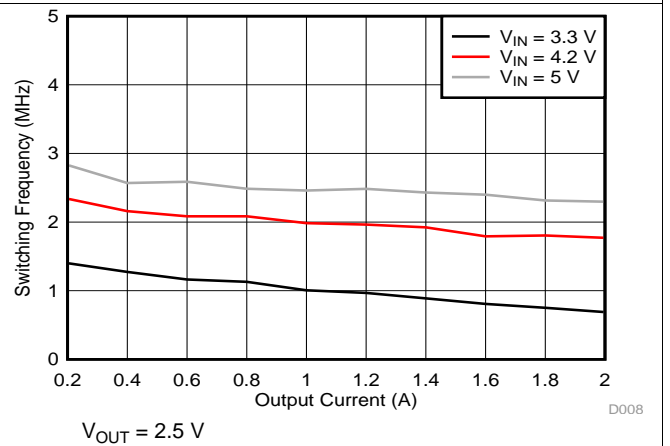

Figure 8. Switching Frequency vs Output Current

8 Detailed Description

8.1 Overview

The TLV62080 and TLV62084 synchronous switched-mode converters are based on DCS-Control. DCS-Control is an advanced regulation topology that combines the advantages of hysteresis and voltage mode control.

The DCS-Control topology operates in PWM (pulse width modulation) mode for medium to heavy load conditions and in power save mode at light load currents. In PWM the TLV6208x converter operates with the nominal switching frequency of 2 MHz, having a controlled frequency variation over the input voltage range. As the load current decreases, the converter enters power save mode, reducing the switching frequency and minimizing the IC quiescent current to achieve high efficiency over the entire load current range. DCS-Control supports both operation modes (PWM and PFM) using a single building block with a seamless transition from PWM to power save mode without effects on the output voltage. The TLV62080 and TLV62084 devices offer both excellent DC voltage and superior load transient regulation, combined with very low output voltage ripple, minimizing interference with RF circuits.

8.2 Functional Block Diagram

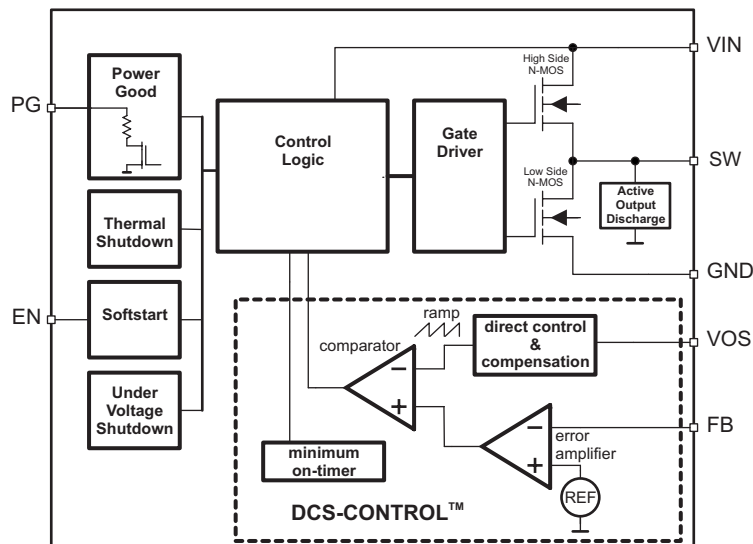

8.3 Feature Description

8.3.1 100% Duty-Cycle Low-Dropout Operation

The devices offer low input-to-output voltage difference by entering the 100% duty-cycle mode. In this mode the high-side MOSFET switch is constantly turned on and the low side MOSFET is switched off. This mode is particularly useful in battery powered applications to achieve the longest operation time by taking full advantage of the whole battery voltage range. Equation 1 calculates the minimum input voltage to maintain switching regulation based on the load current and output voltage.

$$V_{IN,MIN} = V_{OUT} + I_{OUT,MAX} \times (R_{DS(on)} + R_L)$$

With:

- $V_{IN,MIN}$ = Minimum input voltage
- $I_{OUT,MAX}$ = Maximum output current
- $R_{DS(on)}$ = High-side FET on-resistance
- R_L = Inductor ohmic resistance

(1)

Feature Description (continued)

8.3.2 Enabling and Disabling the Device

The device is enabled by setting the EN input to a logic HIGH. Accordingly, a logic LOW disables the device. If the device is enabled, the internal power stage starts switching and regulates the output voltage to the programmed threshold. The EN input must be terminated with a resistance less than 1-M Ω pulled to VIN or GND.

8.3.3 Output Discharge

The output gets discharged by the SW terminal with a typical discharge resistor of R_{DIS} whenever the device shuts down. In this case, the device is disabled by enable, thermal shutdown trigger, and undervoltage lockout trigger.

8.3.4 Soft Start

After enabling the device, an internal soft-start circuitry monotonically ramps up the output voltage and reaches the nominal output voltage during a soft start time (100 μ s, typical). Soft start avoids excessive inrush current and creates a smooth output voltage rise slope. Soft start also prevents excessive voltage drops of primary cells and rechargeable batteries with high internal impedance.

If the output voltage is not reached within the soft start time, such as in the case of heavy load, the converter enters standard operation. Consequently, the inductor current limit operates as described in [Inductor Current-Limit](#). The TLV62080 and TLV62084 devices are able to start into a pre-biased output capacitor. The converter starts with the applied bias voltage and ramps the output voltage to the nominal value.

8.3.5 Power Good

The TLV62080 and TLV62084 devices have a power-good output going low when the output voltage is below the nominal value. The power good maintains high impedance once the output is above 95% of the regulated voltage, and is driven to low once the output voltage falls below typically 90% of the regulated voltage. The PG terminal is an open drain output and is specified to sink typically up to 0.5 mA. The power good output requires a pullup resistor which is recommended connecting to the device output. When the device is off because of disable, UVLO, or thermal shutdown, the PG terminal is at high impedance.

The PG signal can be used for sequencing of multiple rails by connecting to the EN terminal of other converters. Leave the PG terminal unconnected when not in use.

8.3.6 Undervoltage Lockout

To avoid misoperation of the device at low input voltages, an undervoltage lockout is implemented which shuts down the device at voltages lower than V_{UVLO} with a V_{HYS_UVLO} hysteresis.

8.3.7 Thermal Shutdown

The device goes into thermal shutdown once the junction temperature exceeds typically T_{JSD}. Once the device temperature falls below the threshold, the device returns to normal operation automatically.

8.3.8 Inductor Current-Limit

The Inductor current-limit prevents the device from high inductor current and drawing excessive current from the battery or input voltage rail. Excessive current can occur with a shorted or saturated inductor, a heavy load, or shorted output circuit condition.

The incorporated inductor peak-current limit measures the current during the high-side and low-side power MOSFET on-phase in PWM mode. Once the high-side switch current-limit is tripped, the high-side MOSFET is turned off and the low side MOSFET is turned on to reduce the inductor current. Until the inductor current drops down to low-side switch current-limit, the low-side MOSFET is turned off and the high-side switch is turned on again. This operation repeats until the inductor current does not reach the high-side switch current-limit. Because of the internal propagation delay, the real current-limit value exceeds the static-current limit in the [Electrical Characteristics](#) table.

8.4 Device Functional Modes

8.4.1 Power Save Mode

As the load current decreases the TLV62080 and TLV62084 devices enter the power save mode operation. During power save mode the converter operates with reduced switching frequency in PFM mode and with a minimum quiescent current maintaining high efficiency. The power save mode occurs when the inductor current becomes discontinuous which is based on a fixed on time architecture. The typical on time is given by $t_{on} = 400 \text{ ns} \times (V_{OUT} / V_{IN})$. The switching frequency over the whole load current range is shown in [Figure 8](#).

9 Application and Implementation

9.1 Application Information

The devices are designed to operate from an input voltage supply range between 2.5 V (2.7 V for the TLV62084 device) and 5.5 V with a maximum output current of 2 A (1.2 A for the TLV62080 device). The TLV6208x device operates in PWM mode for medium to heavy load conditions and in power save mode at light load currents.

In PWM mode the TLV6208x converter operates with the nominal switching frequency of 2 MHz which provides a controlled frequency variation over the input voltage range. As the load current decreases, the converter enters power save mode, reducing the switching frequency and minimizing the IC quiescent current to achieve high efficiency over the entire load current range.

The WEBENCH software uses an iterative design procedure and accesses a comprehensive database of components when generating a design. See the [Documentation Support](#) section for additional documentation.

9.2 Typical Application

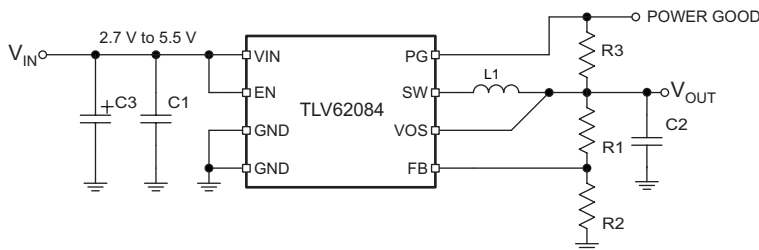

Figure 9. Typical Application Schematic

9.2.1 Design Requirements

Use the following typical application design procedure to select external components values for the TLV6208x device.

Table 2. Design Parameters

DESIGN PARAMETERS	EXAMPLE VALUES
Input Voltage Range	2.8 V to 4.2 V
Output Voltage	1.2 V
Transient Response	$\pm 5\% V_{OUT}$
Input Voltage Ripple	400 mV
Output Voltage Ripple	30 mV
Output Current Rating	2 A
Operating frequency	2 MHz

9.2.2 Detailed Design Procedure

Table 3. List of Components

REFERENCE	DESCRIPTION	MANUFACTURER
C1	10 μ F, Ceramic Capacitor, 6.3 V, X5R, size 0603	Std
C2	22 μ F, Ceramic Capacitor, 6.3 V, X5R, size 0805, GRM21BR60J226ME39L	Murata
C3	47 μ F, Tantalum Capacitor, 8 V, 35 m Ω , size 3528, T520B476M008ATE035	Kemet
L1	1 μ H, Power Inductor, 2.2 A, size 3 mm \times 3 mm \times 1.2 mm, XFL3012-102MEB	Coilcraft
R1	65.3 k Ω , Chip Resistor, 1/16 W, 1%, size 0603	Std
R2	39.2 k Ω , Chip Resistor, 1/16 W, 1%, size 0603	Std
R3	178 k Ω , Chip Resistor, 1/16 W, 1%, size 0603	Std

9.2.2.1 Output Filter Design

The inductor and the output capacitor together provide a low pass frequency filter. To simplify this process [Table 4](#) outlines possible inductor and capacitor value combinations for the most application.

Table 4. Matrix of Output Capacitor and Inductor Combinations

L [μ H] ⁽¹⁾	C _{OUT} [μ F] ⁽¹⁾				
	10	22	47	100	150
0.47					
1	+	+(2)(3)	+	+	
2.2	+	+	+	+	
4.7					

- (1) Capacitance tolerance and bias voltage de-rating is anticipated. The effective capacitance can vary by +20% and –50%. Inductor tolerance and current de-rating is anticipated. The effective inductance can vary by +20% and –30%.
- (2) Plus signs (+) indicates recommended filter combinations.
- (3) Filter combination in typical application.

9.2.2.2 Inductor Selection

Main parameter for the inductor selection is the inductor value and then the saturation current of the inductor. To calculate the maximum inductor current under static load conditions, [Equation 2](#) is given.

$$I_{L,MAX} = I_{OUT,MAX} + \frac{\Delta I_L}{2}$$

$$\Delta I_L = V_{OUT} \times \frac{1 - \frac{V_{OUT}}{V_{IN}}}{L \times f_{SW}}$$

Where

- $I_{OUT,MAX}$ = Maximum output current
- ΔI_L = Inductor current ripple
- f_{SW} = Switching frequency
- L = Inductor value

(2)

TI recommends choosing the saturation current for the inductor 20% to approximately 30% higher than the $I_{L,MAX}$, out of [Equation 2](#). A higher inductor value is also useful to lower ripple current, but increases the transient response time as well. The following inductors are recommended to be used in designs (see [Table 5](#)).

Table 5. List of Recommended Inductors

INDUCTANCE [μH]	CURRENT RATING [mA]	DIMENSIONS L x W x H [mm ³]	DC RESISTANCE [mΩ typ]	TYPE	MANUFACTURER
1	2500	3 × 3 × 1.2	35	XFL3012-102ME	Coilcraft
1	1650	3 × 3 × 1.2	40	LQH3NPN1R0NJ0	Murata
2.2	2500	4 × 3.7 × 1.65	49	LQH44PN2R2MP0	Murata
2.2	1600	3 × 3 × 1.2	81	XFL3012-222ME	Coilcraft

9.2.2.3 Capacitor Selection

The input capacitor is the low impedance energy source for the converter which helps to provide stable operation. A low ESR multilayer ceramic capacitor is recommended for best filtering and must be placed between VIN and GND as close as possible to those terminals. For most applications 10 μF is sufficient, a larger value reduces input current ripple.

The architecture of the TLV6208x device allows use of tiny ceramic-type output capacitors with low equivalent-series resistance (ESR). These capacitors provide low output voltage ripple and are recommended. To keep the resistance up to high frequencies and to get narrow capacitance variation with temperature, TI recommends use of the X7R or X5R dielectric. The TLV62080 and TLV62084 devices are designed to operate with an output capacitance of 10 to 100 μF, as listed in [Table 4](#).

Table 6. List of Recommended Capacitors

CAPACITANCE [μF]	TYPE	DIMENSIONS L x W x H [mm ³]	MANUFACTURER
10	GRM188R60J106M	0603: 1.6 × 0.8 × 0.8	Murata
22	GRM188R60G226M	0603: 1.6 × 0.8 × 0.8	Murata
22	GRM21BR60J226M	0805: 2 × 1.2 × 1.25	Murata

9.2.2.4 Setting the Output Voltage

By selecting R₁ and R₂, the output voltage is programmed to the desired value. Use [Equation 3](#) to calculate R₁ and R₂.

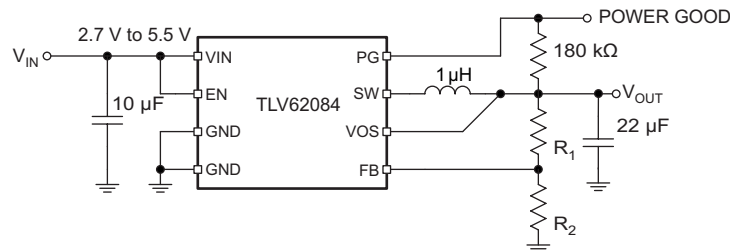

Figure 10. Typical Application Circuit

$$V_{OUT} = V_{FB} \times \left(1 + \frac{R_1}{R_2}\right) = 0.45V \times \left(1 + \frac{R_1}{R_2}\right) \quad (3)$$

For best accuracy, R₂ must be kept smaller than 40 kΩ to ensure that the current flowing through R₂ is at least 100-times larger than I_{FB}. Changing the sum towards a lower value increases the robustness against noise injection. Changing the sum towards higher values reduces the quiescent current.

9.2.3 Application Curves

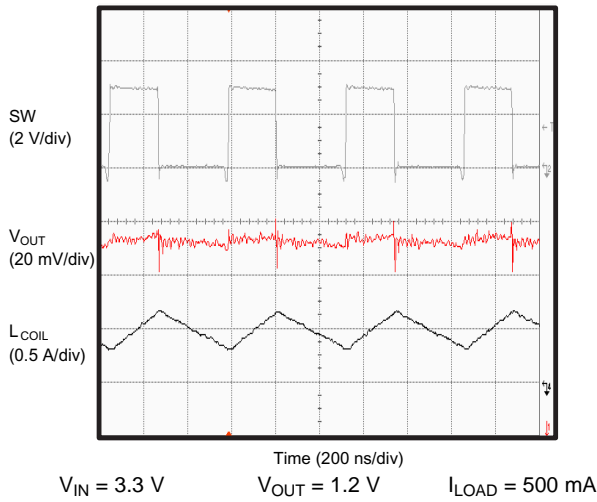

Figure 11. Typical Application (PWM Mode)

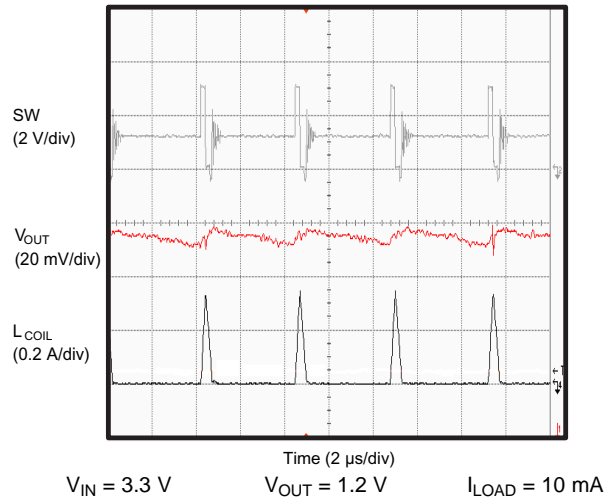

Figure 12. Typical Application (PFM Mode)

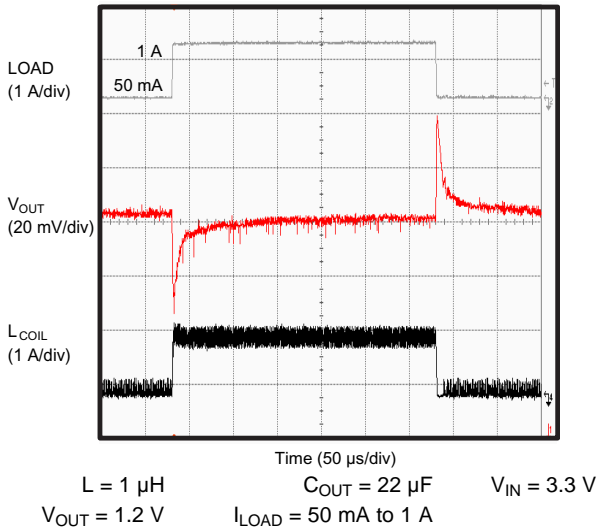

Figure 13. Load Transient

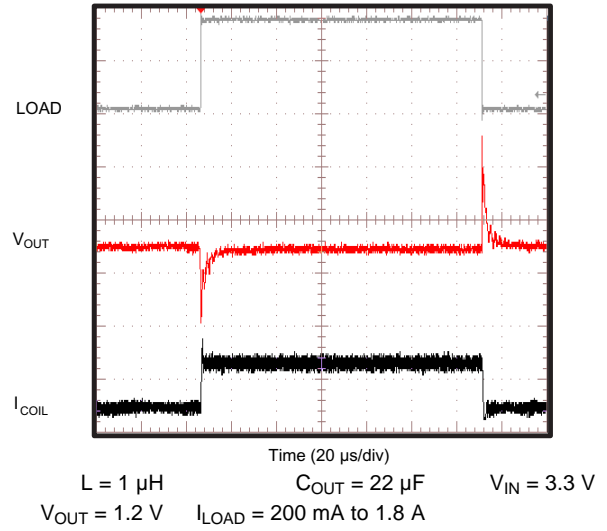

Figure 14. Load Transient

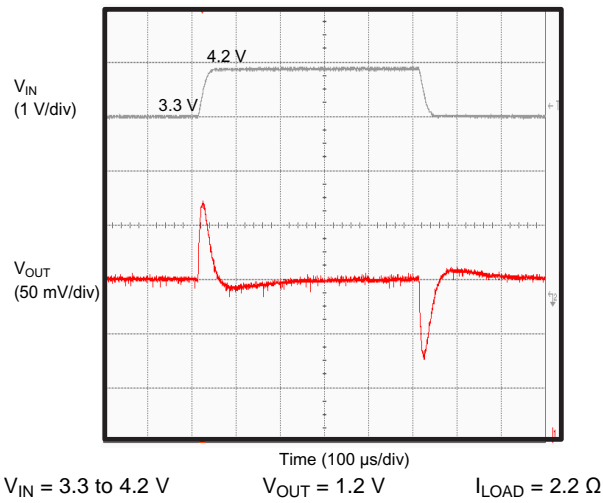

Figure 15. Line Transient

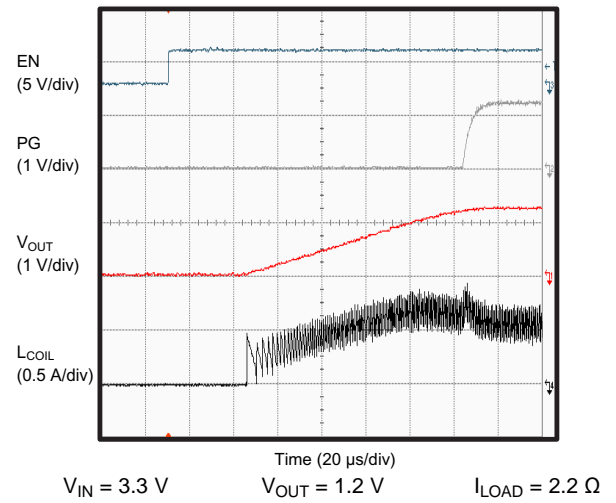

Figure 16. Startup

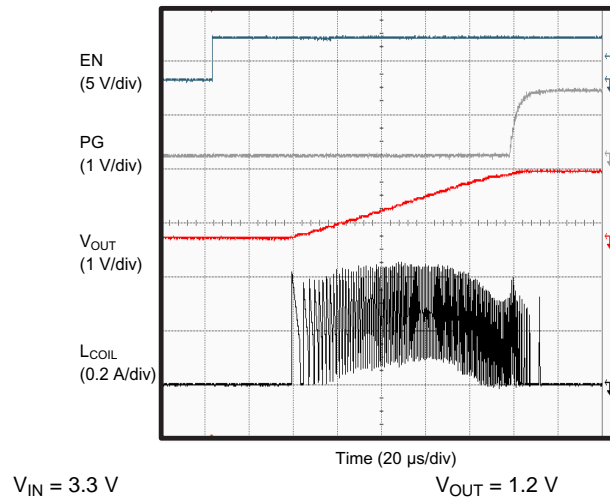

Figure 17. Startup (No Load)

10 Power Supply Recommendations

The devices are designed to operate from an input voltage supply range between 2.5 V (2.7 V for the TLV62084 device) and 5.5 V. This input supply must be well regulated. If the input supply is located more than a few inches from the TLV6208x converter additional bulk capacitance may be required in addition to the ceramic bypass capacitors. An electrolytic or tantalum capacitor with a value of 47 μF is a typical choice.

11 Layout

11.1 Layout Guidelines

The PCB layout is an important step to maintain the high performance of the TLV62080 and TLV62084 devices.

- Place input and output capacitors, along with the inductor, as close as possible to the IC which keeps the traces short. Routing these traces direct and wide results in low trace resistance and low parasitic inductance.
- Use a common-power GND.
- Properly connect the low side of the input and output capacitors to the power GND to avoid a GND potential shift.
- The sense traces connected to FB and VOS terminals are signal traces. Keep these traces away from SW nodes.
- Use care to avoid noise induction. By a direct routing, parasitic inductance can be kept small.
- Use GND layers for shielding if needed.

11.2 Layout Example

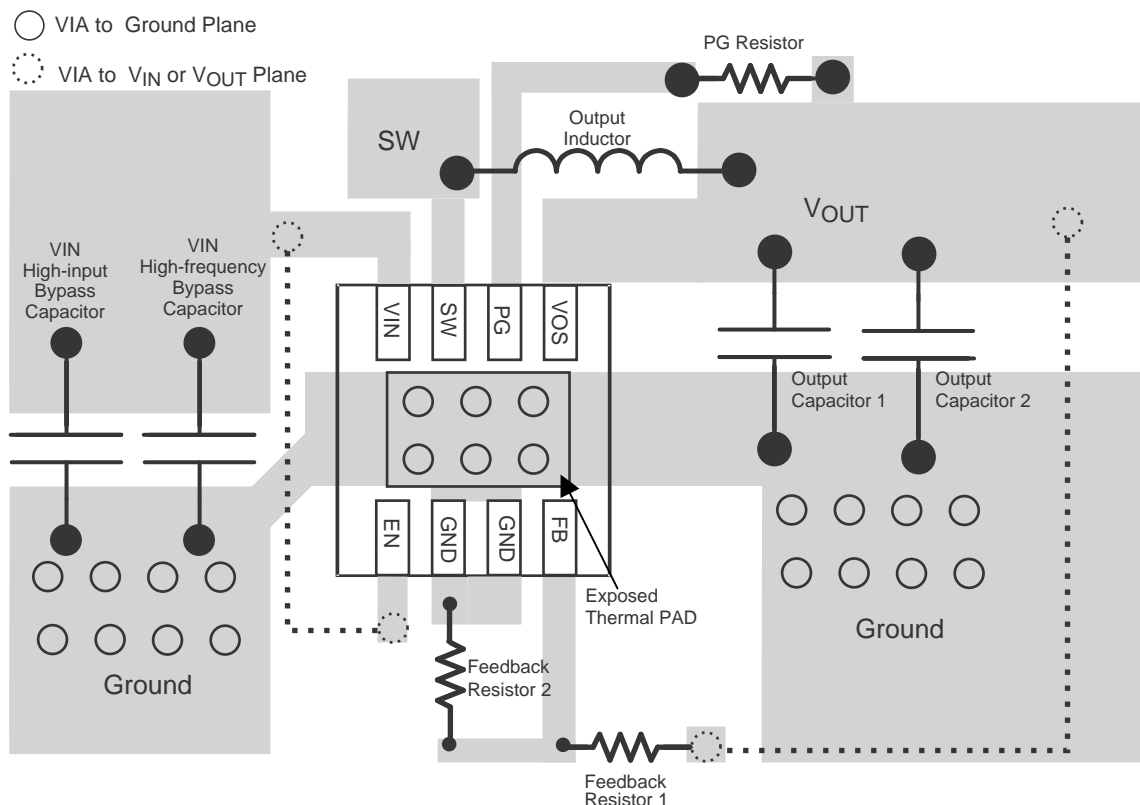

Figure 18. PCB Layout Suggestion

11.3 Thermal Information

Implementation of integrated circuits in low-profile and fine-pitch surface-mount packages typically requires special attention to power dissipation. Many system-dependent issues such as thermal coupling, airflow, added heat sinks and convection surfaces, and the presence of other heat-generating components affect the power-dissipation limits of a given component.

Three basic approaches for enhancing thermal performance are listed below:

- Improving the power dissipation capability of the PCB design.
- Improving the thermal coupling of the component to the PCB by soldering the Thermal Pad.
- Introducing airflow in the system.

For more details on how to use the thermal parameters, see the Thermal Characteristics application notes [SZZA017](#) and [SPRA953](#).

12 Device and Documentation Support

12.1 Device Support

12.1.1 Third-Party Products Disclaimer

TI'S PUBLICATION OF INFORMATION REGARDING THIRD-PARTY PRODUCTS OR SERVICES DOES NOT CONSTITUTE AN ENDORSEMENT REGARDING THE SUITABILITY OF SUCH PRODUCTS OR SERVICES OR A WARRANTY, REPRESENTATION OR ENDORSEMENT OF SUCH PRODUCTS OR SERVICES, EITHER ALONE OR IN COMBINATION WITH ANY TI PRODUCT OR SERVICE.

12.2 Documentation Support

For related documentation see the following:

- TLV62080EVM-756 User's Guide, *TLV62080, 1.2-A, High-Efficiency, Step-Down Converter in 2-mm x 2-mm SON Package*, [SLVU640](#)

12.3 Related Links

The table below lists quick access links. Categories include technical documents, support and community resources, tools and software, and quick access to sample or buy.

Table 7. Related Links

PARTS	PRODUCT FOLDER	SAMPLE & BUY	TECHNICAL DOCUMENTS	TOOLS & SOFTWARE	SUPPORT & COMMUNITY
TLV62080	Click here	Click here	Click here	Click here	Click here
TLV62084	Click here	Click here	Click here	Click here	Click here

12.4 Trademarks

DCS-Control is a trademark of Texas Instruments.
All other trademarks are the property of their respective owners.

12.5 Electrostatic Discharge Caution



This integrated circuit can be damaged by ESD. Texas Instruments recommends that all integrated circuits be handled with appropriate precautions. Failure to observe proper handling and installation procedures can cause damage.

ESD damage can range from subtle performance degradation to complete device failure. Precision integrated circuits may be more susceptible to damage because very small parametric changes could cause the device not to meet its published specifications.

12.6 Glossary

[SLYZ022](#) — *TI Glossary*.

This glossary lists and explains terms, acronyms and definitions.

13 Mechanical, Packaging, and Orderable Information

The following pages include mechanical packaging and orderable information. This information is the most current data available for the designated devices. This data is subject to change without notice and revision of this document. For browser-based versions of this data sheet, refer to the left-hand navigation.

PACKAGING INFORMATION

Orderable Device	Status (1)	Package Type	Package Drawing	Pins	Package Qty	Eco Plan (2)	Lead/Ball Finish (6)	MSL Peak Temp (3)	Op Temp (°C)	Device Marking (4/5)	Samples
TLV62080DSGR	ACTIVE	WS0N	DSG	8	3000	Green (RoHS & no Sb/Br)	CU NIPDAU	Level-2-260C-1 YEAR	-40 to 85	RAU	Samples
TLV62080DSGT	ACTIVE	WS0N	DSG	8	250	Green (RoHS & no Sb/Br)	CU NIPDAU	Level-2-260C-1 YEAR	-40 to 85	RAU	Samples
TLV62084DSGR	ACTIVE	WS0N	DSG	8	3000	Green (RoHS & no Sb/Br)	CU NIPDAU	Level-2-260C-1 YEAR	-40 to 85		Samples
TLV62084DSGT	ACTIVE	WS0N	DSG	8	250	Green (RoHS & no Sb/Br)	CU NIPDAU	Level-2-260C-1 YEAR	-40 to 85		Samples

(1) The marketing status values are defined as follows:

ACTIVE: Product device recommended for new designs.

LIFEBUY: TI has announced that the device will be discontinued, and a lifetime-buy period is in effect.

NRND: Not recommended for new designs. Device is in production to support existing customers, but TI does not recommend using this part in a new design.

PREVIEW: Device has been announced but is not in production. Samples may or may not be available.

OBSELETE: TI has discontinued the production of the device.

(2) Eco Plan - The planned eco-friendly classification: Pb-Free (RoHS), Pb-Free (RoHS Exempt), or Green (RoHS & no Sb/Br) - please check <http://www.ti.com/productcontent> for the latest availability information and additional product content details.

TBD: The Pb-Free/Green conversion plan has not been defined.

Pb-Free (RoHS): TI's terms "Lead-Free" or "Pb-Free" mean semiconductor products that are compatible with the current RoHS requirements for all 6 substances, including the requirement that lead not exceed 0.1% by weight in homogeneous materials. Where designed to be soldered at high temperatures, TI Pb-Free products are suitable for use in specified lead-free processes.

Pb-Free (RoHS Exempt): This component has a RoHS exemption for either 1) lead-based flip-chip solder bumps used between the die and package, or 2) lead-based die adhesive used between the die and leadframe. The component is otherwise considered Pb-Free (RoHS compatible) as defined above.

Green (RoHS & no Sb/Br): TI defines "Green" to mean Pb-Free (RoHS compatible), and free of Bromine (Br) and Antimony (Sb) based flame retardants (Br or Sb do not exceed 0.1% by weight in homogeneous material)

(3) MSL, Peak Temp. - The Moisture Sensitivity Level rating according to the JEDEC industry standard classifications, and peak solder temperature.

(4) There may be additional marking, which relates to the logo, the lot trace code information, or the environmental category on the device.

(5) Multiple Device Markings will be inside parentheses. Only one Device Marking contained in parentheses and separated by a "~" will appear on a device. If a line is indented then it is a continuation of the previous line and the two combined represent the entire Device Marking for that device.

(6) Lead/Ball Finish - Orderable Devices may have multiple material finish options. Finish options are separated by a vertical ruled line. Lead/Ball Finish values may wrap to two lines if the finish value exceeds the maximum column width.

Important Information and Disclaimer: The information provided on this page represents TI's knowledge and belief as of the date that it is provided. TI bases its knowledge and belief on information provided by third parties, and makes no representation or warranty as to the accuracy of such information. Efforts are underway to better integrate information from third parties. TI has taken and continues to take reasonable steps to provide representative and accurate information but may not have conducted destructive testing or chemical analysis on incoming materials and chemicals. TI and TI suppliers consider certain information to be proprietary, and thus CAS numbers and other limited information may not be available for release.

In no event shall TI's liability arising out of such information exceed the total purchase price of the TI part(s) at issue in this document sold by TI to Customer on an annual basis.

TAPE AND REEL INFORMATION

QUADRANT ASSIGNMENTS FOR PIN 1 ORIENTATION IN TAPE

*All dimensions are nominal

Device	Package Type	Package Drawing	Pins	SPQ	Reel Diameter (mm)	Reel Width W1 (mm)	A0 (mm)	B0 (mm)	K0 (mm)	P1 (mm)	W (mm)	Pin1 Quadrant
TLV62080DSGR	WSON	DSG	8	3000	179.0	8.4	2.2	2.2	1.2	4.0	8.0	Q2
TLV62080DSGT	WSON	DSG	8	250	179.0	8.4	2.2	2.2	1.2	4.0	8.0	Q2
TLV62084DSGR	WSON	DSG	8	3000	180.0	8.4	2.3	2.3	1.15	4.0	8.0	Q2
TLV62084DSGT	WSON	DSG	8	250	180.0	8.4	2.3	2.3	1.15	4.0	8.0	Q2

TAPE AND REEL BOX DIMENSIONS

*All dimensions are nominal

Device	Package Type	Package Drawing	Pins	SPQ	Length (mm)	Width (mm)	Height (mm)
TLV62080DSGR	WSON	DSG	8	3000	195.0	200.0	45.0
TLV62080DSGT	WSON	DSG	8	250	195.0	200.0	45.0
TLV62084DSGR	WSON	DSG	8	3000	210.0	185.0	35.0
TLV62084DSGT	WSON	DSG	8	250	210.0	185.0	35.0

DSG (S-PWSON-N8)

PLASTIC SMALL OUTLINE NO-LEAD

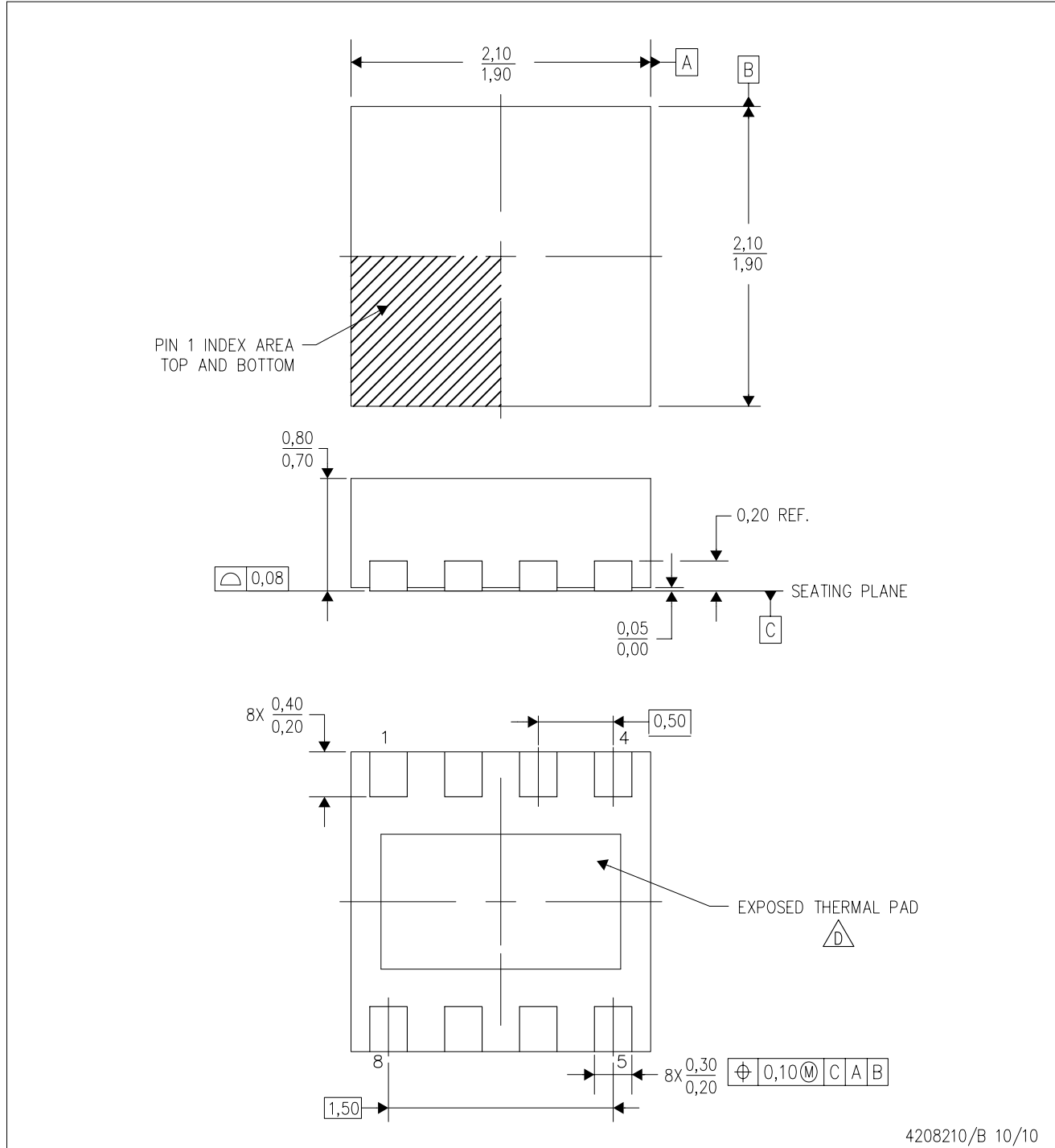

4208210/B 10/10

- NOTES:
- A. All linear dimensions are in millimeters. Dimensioning and tolerancing per ASME Y14.5M-1994.
 - B. This drawing is subject to change without notice.
 - C. Quad Flatpack, No-Leads (QFN) package configuration.
 -  The package thermal pad must be soldered to the board for thermal and mechanical performance. See the Product Data Sheet for details regarding the exposed thermal pad dimensions.
 - E. Falls within JEDEC MO-229.

THERMAL PAD MECHANICAL DATA

DSG (S-PWSON-N8)

PLASTIC SMALL OUTLINE NO-LEAD

THERMAL INFORMATION

This package incorporates an exposed thermal pad that is designed to be attached directly to an external heatsink. The thermal pad must be soldered directly to the printed circuit board (PCB). After soldering, the PCB can be used as a heatsink. In addition, through the use of thermal vias, the thermal pad can be attached directly to the appropriate copper plane shown in the electrical schematic for the device, or alternatively, can be attached to a special heatsink structure designed into the PCB. This design optimizes the heat transfer from the integrated circuit (IC).

For information on the Quad Flatpack No-Lead (QFN) package and its advantages, refer to Application Report, QFN/SON PCB Attachment, Texas Instruments Literature No. SLUA271. This document is available at www.ti.com.

The exposed thermal pad dimensions for this package are shown in the following illustration.

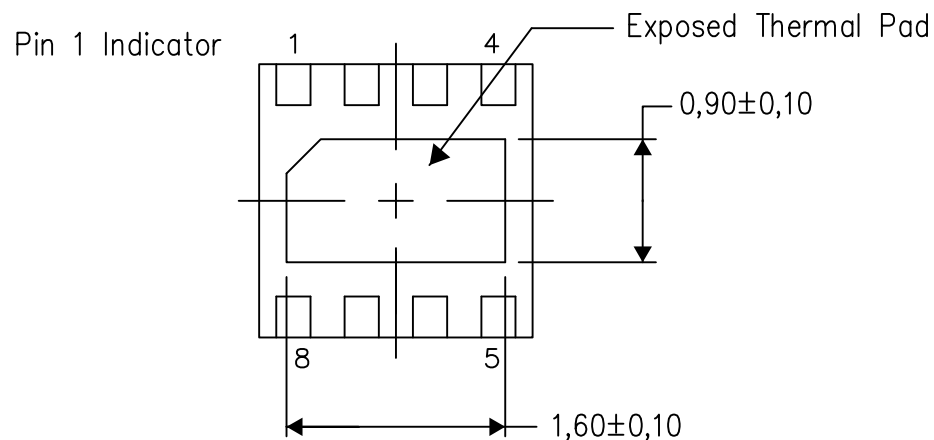

Bottom View

Exposed Thermal Pad Dimensions

4208347/G 08/13

NOTE: All linear dimensions are in millimeters

DSG (S-PWSON-N8)

PLASTIC SMALL OUTLINE NO-LEAD

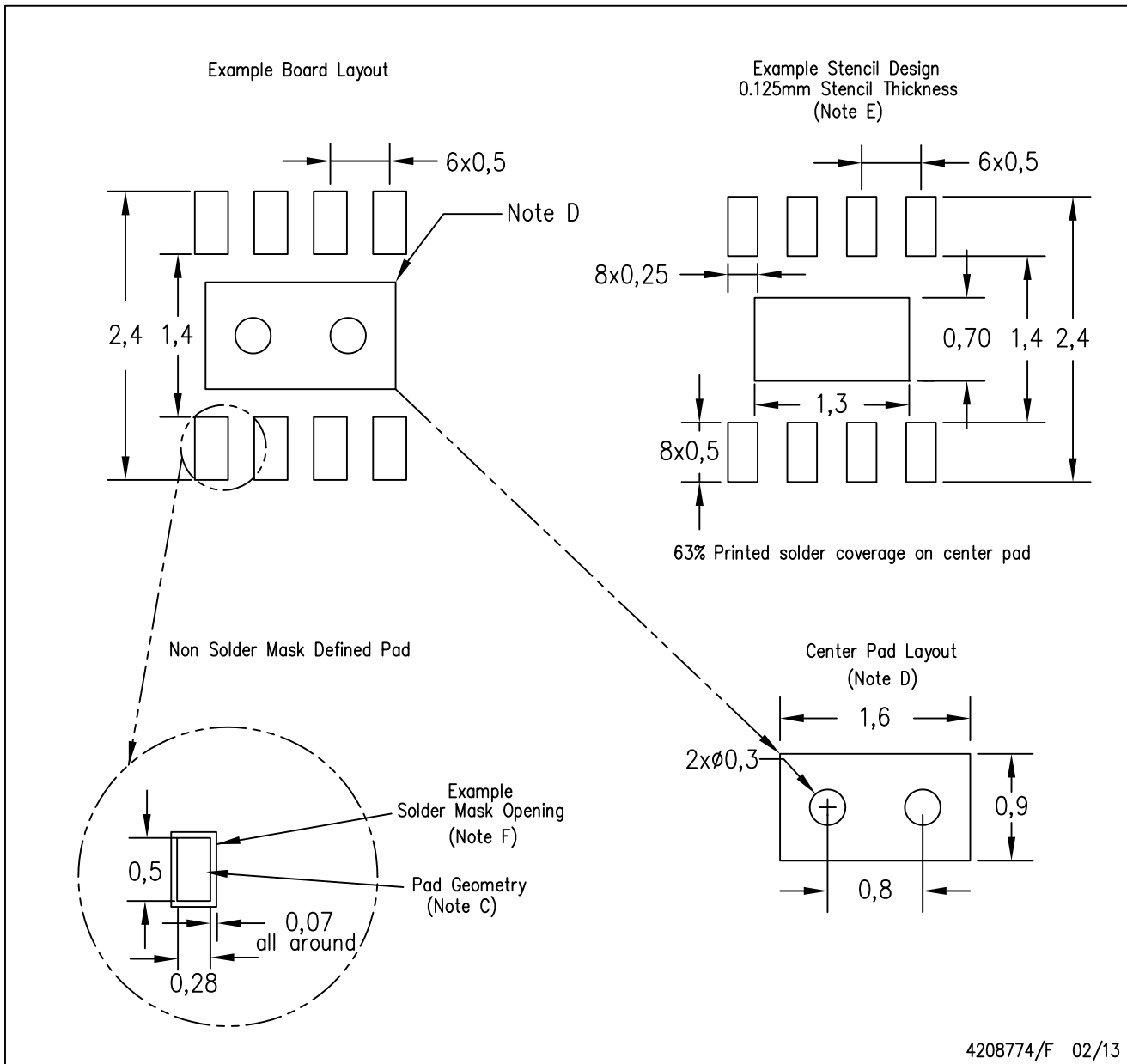

- NOTES:
- A. All linear dimensions are in millimeters.
 - B. This drawing is subject to change without notice.
 - C. Publication IPC-7351 is recommended for alternate designs.
 - D. This package is designed to be soldered to a thermal pad on the board. Refer to Application Note, QFN/SON PCB Attachment, Texas Instruments Literature No. SLUA271, and also the Product Data Sheets for specific thermal information, via requirements, and recommended board layout. These documents are available at www.ti.com <<http://www.ti.com>>.
 - E. Laser cutting apertures with trapezoidal walls and also rounding corners will offer better paste release. Customers should contact their board assembly site for stencil design recommendations. Refer to IPC 7525 for stencil design considerations.
 - F. Customers should contact their board fabrication site for solder mask tolerances.

IMPORTANT NOTICE

Texas Instruments Incorporated and its subsidiaries (TI) reserve the right to make corrections, enhancements, improvements and other changes to its semiconductor products and services per JESD46, latest issue, and to discontinue any product or service per JESD48, latest issue. Buyers should obtain the latest relevant information before placing orders and should verify that such information is current and complete. All semiconductor products (also referred to herein as "components") are sold subject to TI's terms and conditions of sale supplied at the time of order acknowledgment.

TI warrants performance of its components to the specifications applicable at the time of sale, in accordance with the warranty in TI's terms and conditions of sale of semiconductor products. Testing and other quality control techniques are used to the extent TI deems necessary to support this warranty. Except where mandated by applicable law, testing of all parameters of each component is not necessarily performed.

TI assumes no liability for applications assistance or the design of Buyers' products. Buyers are responsible for their products and applications using TI components. To minimize the risks associated with Buyers' products and applications, Buyers should provide adequate design and operating safeguards.

TI does not warrant or represent that any license, either express or implied, is granted under any patent right, copyright, mask work right, or other intellectual property right relating to any combination, machine, or process in which TI components or services are used. Information published by TI regarding third-party products or services does not constitute a license to use such products or services or a warranty or endorsement thereof. Use of such information may require a license from a third party under the patents or other intellectual property of the third party, or a license from TI under the patents or other intellectual property of TI.

Reproduction of significant portions of TI information in TI data books or data sheets is permissible only if reproduction is without alteration and is accompanied by all associated warranties, conditions, limitations, and notices. TI is not responsible or liable for such altered documentation. Information of third parties may be subject to additional restrictions.

Resale of TI components or services with statements different from or beyond the parameters stated by TI for that component or service voids all express and any implied warranties for the associated TI component or service and is an unfair and deceptive business practice. TI is not responsible or liable for any such statements.

Buyer acknowledges and agrees that it is solely responsible for compliance with all legal, regulatory and safety-related requirements concerning its products, and any use of TI components in its applications, notwithstanding any applications-related information or support that may be provided by TI. Buyer represents and agrees that it has all the necessary expertise to create and implement safeguards which anticipate dangerous consequences of failures, monitor failures and their consequences, lessen the likelihood of failures that might cause harm and take appropriate remedial actions. Buyer will fully indemnify TI and its representatives against any damages arising out of the use of any TI components in safety-critical applications.

In some cases, TI components may be promoted specifically to facilitate safety-related applications. With such components, TI's goal is to help enable customers to design and create their own end-product solutions that meet applicable functional safety standards and requirements. Nonetheless, such components are subject to these terms.

No TI components are authorized for use in FDA Class III (or similar life-critical medical equipment) unless authorized officers of the parties have executed a special agreement specifically governing such use.

Only those TI components which TI has specifically designated as military grade or "enhanced plastic" are designed and intended for use in military/aerospace applications or environments. Buyer acknowledges and agrees that any military or aerospace use of TI components which have **not** been so designated is solely at the Buyer's risk, and that Buyer is solely responsible for compliance with all legal and regulatory requirements in connection with such use.

TI has specifically designated certain components as meeting ISO/TS16949 requirements, mainly for automotive use. In any case of use of non-designated products, TI will not be responsible for any failure to meet ISO/TS16949.

Products

Audio	www.ti.com/audio
Amplifiers	amplifier.ti.com
Data Converters	dataconverter.ti.com
DLP® Products	www.dlp.com
DSP	dsp.ti.com
Clocks and Timers	www.ti.com/clocks
Interface	interface.ti.com
Logic	logic.ti.com
Power Mgmt	power.ti.com
Microcontrollers	microcontroller.ti.com
RFID	www.ti-rfid.com
OMAP Applications Processors	www.ti.com/omap
Wireless Connectivity	www.ti.com/wirelessconnectivity

Applications

Automotive and Transportation	www.ti.com/automotive
Communications and Telecom	www.ti.com/communications
Computers and Peripherals	www.ti.com/computers
Consumer Electronics	www.ti.com/consumer-apps
Energy and Lighting	www.ti.com/energy
Industrial	www.ti.com/industrial
Medical	www.ti.com/medical
Security	www.ti.com/security
Space, Avionics and Defense	www.ti.com/space-avionics-defense
Video and Imaging	www.ti.com/video

TI E2E Community

e2e.ti.com