

Low Current 0603 LED

Description

The new 0603 LED series have been designed in the smallest SMD package. This innovative 0603 LED technology opens the way to

- smaller products of higher performance
- more design in flexibility
- enhanced applications

The 0603 LED is an obvious solution for small-scale, high power products that are expected to work reliability in an arduous environment.

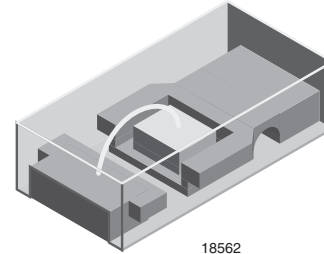

18562

Features

- Smallest SMD package 0603 with exceptional brightness
1.6 mm x 0.8 mm x 0.6 mm (L x W x H)
- High reliability lead frame based
- Temperature range - 40 °C to + 100 °C
- Footprint compatible to 0603 chipled
- Wavelength 633 nm (red), 606 nm (orange), 587 nm (yellow)
- AlInGaP and InGaN technology
- Viewing angle: extremely wide 160°
- Grouping parameter: luminous intensity, wavelength
- Available in 8 mm tape
- Lead-(Pb)-free device



Applications

- Backlight keypads
- Navigation systems
- Cellular phone displays
- Displays for industrial control systems
- Automotive features
- Miniaturized color effects
- Traffic displays

Parts Table

Part	Color, Luminous Intensity
TLMS1000-GS08	Red, $I_V = 4$ mcd (typ.)
TLMO1000-GS08	Soft Orange, $I_V = 8$ mcd (typ.)
TLMY1000-GS08	Yellow, $I_V = 6.5$ mcd (typ.)

Absolute Maximum Ratings

$T_{amb} = 25$ °C, unless otherwise specified

TLMS1000, TLMO1000, TLMY1000

Parameter	Test condition	Symbol	Value	Unit
Reverse voltage ^{*)}		V_R	12	V
DC Forward current	$T_{amb} \leq 95$ °C	I_F	15	mA
Surge forward current	$t_p \leq 10$ μ s	I_{FSM}	0.1	A
Power dissipation	$T_{amb} \leq 95$ °C	P_V	40	mW
Junction temperature		T_j	120	°C
Operating temperature range		T_{amb}	- 40 to + 100	°C
Storage temperature range		T_{stg}	- 40 to + 100	°C
Soldering temperature	acc. Vishay spec	T_{sd}	260	°C
Thermal resistance junction/ambient	mounted on PC board (pad size > 5 mm ²)	R_{thJA}	500	K/W

^{*)} Driving the LED in reverse direction is suitable for short term application

Optical and Electrical Characteristics

$T_{amb} = 25\text{ }^{\circ}\text{C}$, unless otherwise specified

Red

TLMS1000

Parameter	Test condition	Symbol	Min	Typ.	Max	Unit
Luminous intensity ²⁾	$I_F = 2\text{ mA}$	I_V	1.6	4		mcd
Dominant wavelength	$I_F = 2\text{ mA}$	λ_d	624	628	636	nm
Peak wavelength	$I_F = 2\text{ mA}$	λ_p		640		nm
Angle of half intensity	$I_F = 2\text{ mA}$	ϕ		± 80		deg
Forward voltage	$I_F = 2\text{ mA}$	V_F		1.8	2.6	V
Reverse voltage	$I_R = 10\text{ }\mu\text{A}$	V_R	6			V
Junction capacitance	$V_R = 0, f = 1\text{ MHz}$	C_j		15		pF

²⁾ in one Packing Unit $I_{Vmax}/I_{Vmin} \leq 1.6$

Soft Orange

TLMO1000

Parameter	Test condition	Symbol	Min	Typ.	Max	Unit
Luminous intensity ²⁾	$I_F = 2\text{ mA}$	I_V	3.2	7.5		mcd
Dominant wavelength	$I_F = 2\text{ mA}$	λ_d	600	605	609	nm
Peak wavelength	$I_F = 2\text{ mA}$	λ_p		610		nm
Angle of half intensity	$I_F = 2\text{ mA}$	ϕ		± 80		deg
Forward voltage	$I_F = 2\text{ mA}$	V_F		1.8	2.6	V
Reverse voltage	$I_R = 10\text{ }\mu\text{A}$	V_R	6			V
Junction capacitance	$V_R = 0, f = 1\text{ MHz}$	C_j		15		pF

²⁾ in one Packing Unit $I_{Vmax}/I_{Vmin} \leq 1.6$

Yellow

TLMY1000

Parameter	Test condition	Symbol	Min	Typ.	Max	Unit
Luminous intensity ²⁾	$I_F = 2\text{ mA}$	I_V	3.2	7.5		mcd
Dominant wavelength	$I_F = 2\text{ mA}$	λ_d	580	588	595	nm
Peak wavelength	$I_F = 2\text{ mA}$	λ_p		591		nm
Angle of half intensity	$I_F = 2\text{ mA}$	ϕ		± 80		deg
Forward voltage	$I_F = 2\text{ mA}$	V_F		1.8	2.6	V
Reverse voltage	$I_R = 10\text{ }\mu\text{A}$	V_R	6			V
Junction capacitance	$V_R = 0, f = 1\text{ MHz}$	C_j		15		pF

²⁾ in one Packing Unit $I_{Vmax}/I_{Vmin} \leq 1.6$



Color Classification

Group	Dominant Wavelength (nm)			
	Yellow		Orange	
	min	max	min	max
1				
2	580	583	600	603
3	583	586	602	605
4	586	589	604	607
5	589	592	606	609
6	592	595		

Luminous Intensity Classification

Group	Luminous Intensity (mcd)	
	min	max
Ma	1.6	2.5
Mb	2	3.2
Na	2.5	4
Nb	3.2	5
Pa	4	6.3
Pb	5	8
Qa	6.3	10
Qb	8	12.5
Ra	10	16
Rb	12.5	20
Sa	16	25
Sb	20	32

Group Name on Label

Luminous Intensity Group	Halfgroup	Wavelength	Forward Voltage
Q	b	4	1

One packing unit/tape contains only one classification group of luminous intensity, color and forward voltage.

Only one single classification groups is not available.

The given groups are not order codes, customer specific group combinations require marketing agreement.

No color subgrouping for Super Red.

Typical Characteristics (T_{amb} = 25 °C unless otherwise specified)

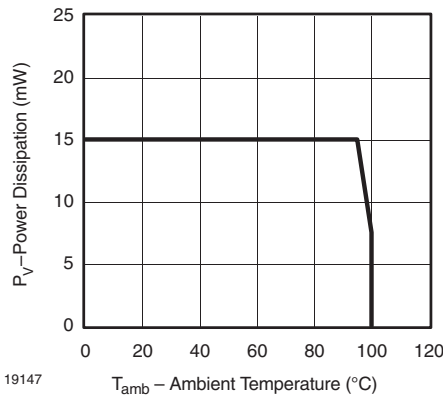

Figure 1. Power Dissipation vs. Ambient Temperature

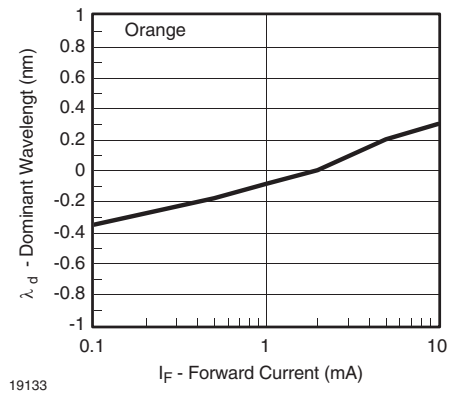

Figure 4. Dominant Wavelength vs. Forward Current

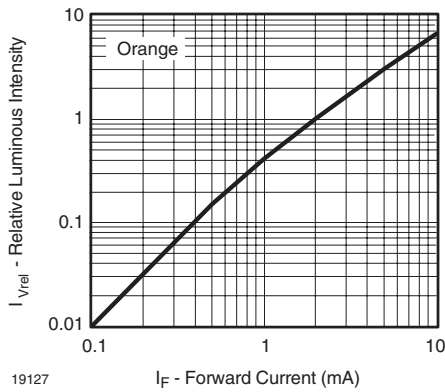

Figure 2. Relative Luminous Intensity vs. Forward Current

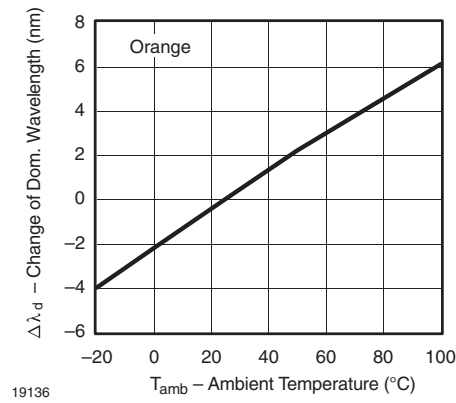

Figure 5. Change of Dominant Wavelength vs. Ambient Temperature

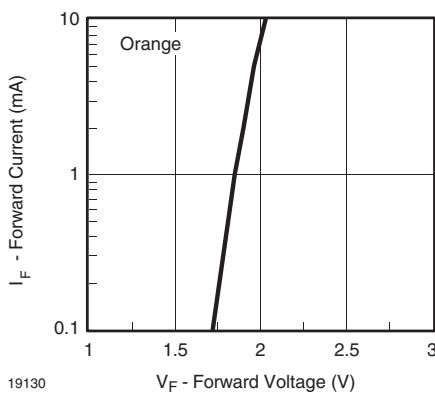

Figure 3. Forward Current vs. Forward Voltage

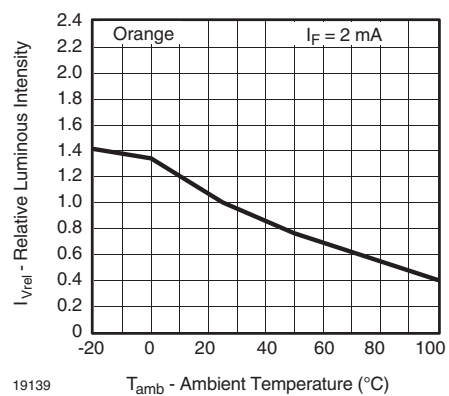

Figure 6. Relative Luminous Intensity vs. Amb. Temperature

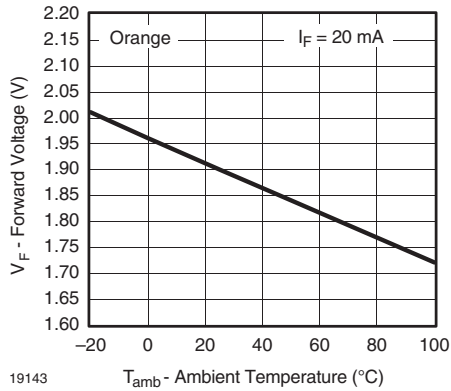

Figure 7. Forward Voltage vs. Ambient Temperature

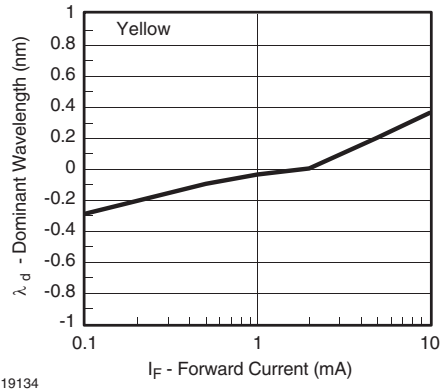

Figure 10. Dominant Wavelength vs. Forward Current

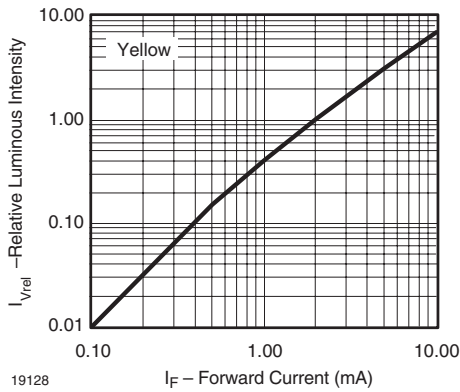

Figure 8. Relative Luminous Intensity vs. Forward Current

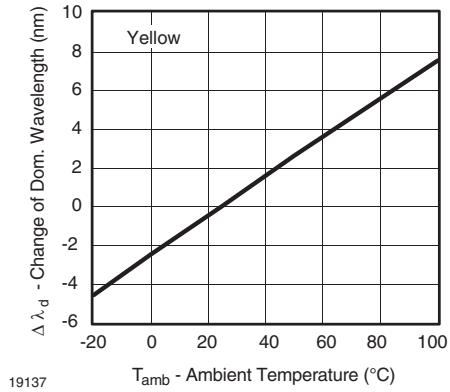

Figure 11. Change of Dominant Wavelength vs. Ambient Temperature

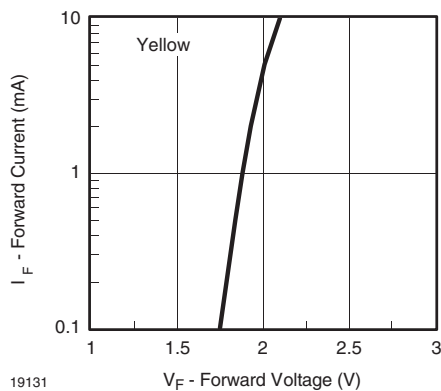

Figure 9. Forward Current vs. Forward Voltage

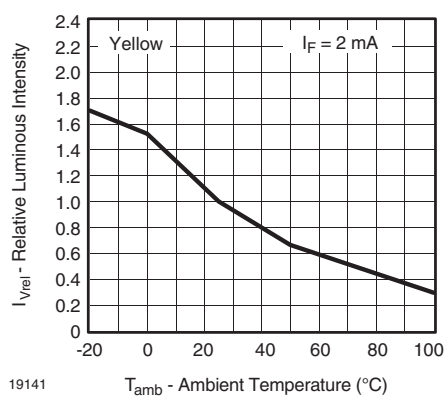

Figure 12. Relative Luminous Intensity vs. Amb. Temperature

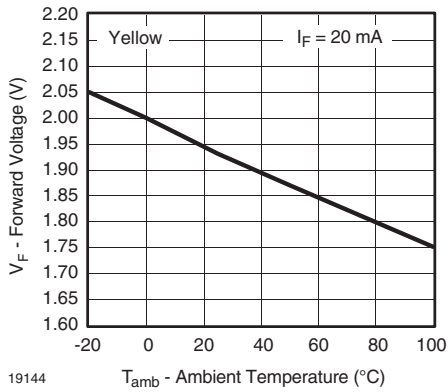

Figure 13. Forward Voltage vs. Ambient Temperature

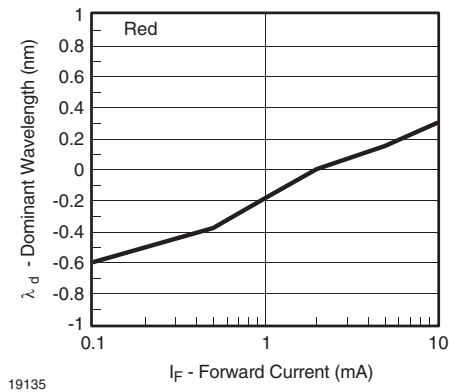

Figure 16. Dominant Wavelength vs. Forward Current

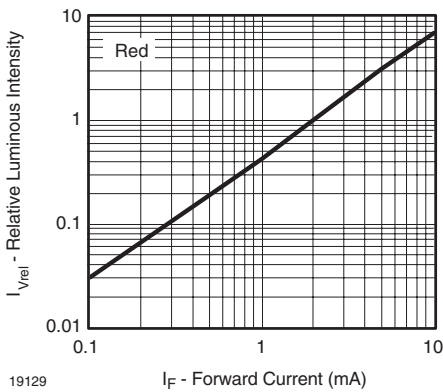

Figure 14. Relative Luminous Intensity vs. Forward Current

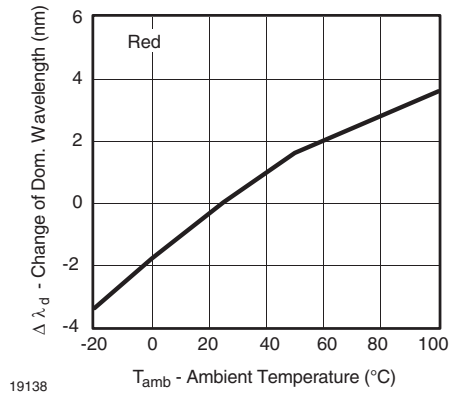

Figure 17. Change of Dominant Wavelength vs. Ambient Temperature

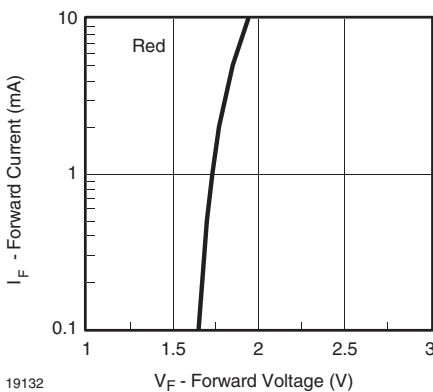

Figure 15. Forward Current vs. Forward Voltage

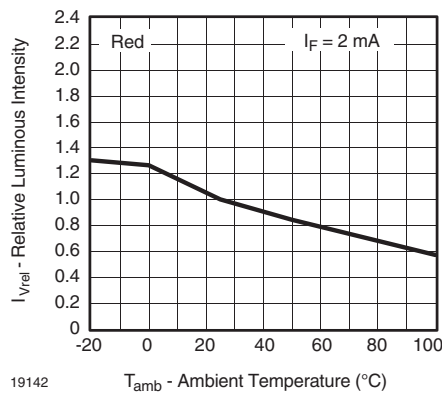

Figure 18. Relative Luminous Intensity vs. Amb. Temperature

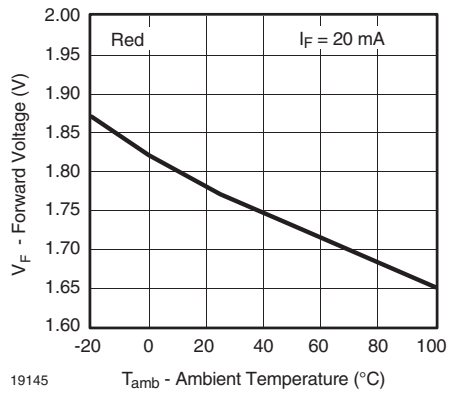
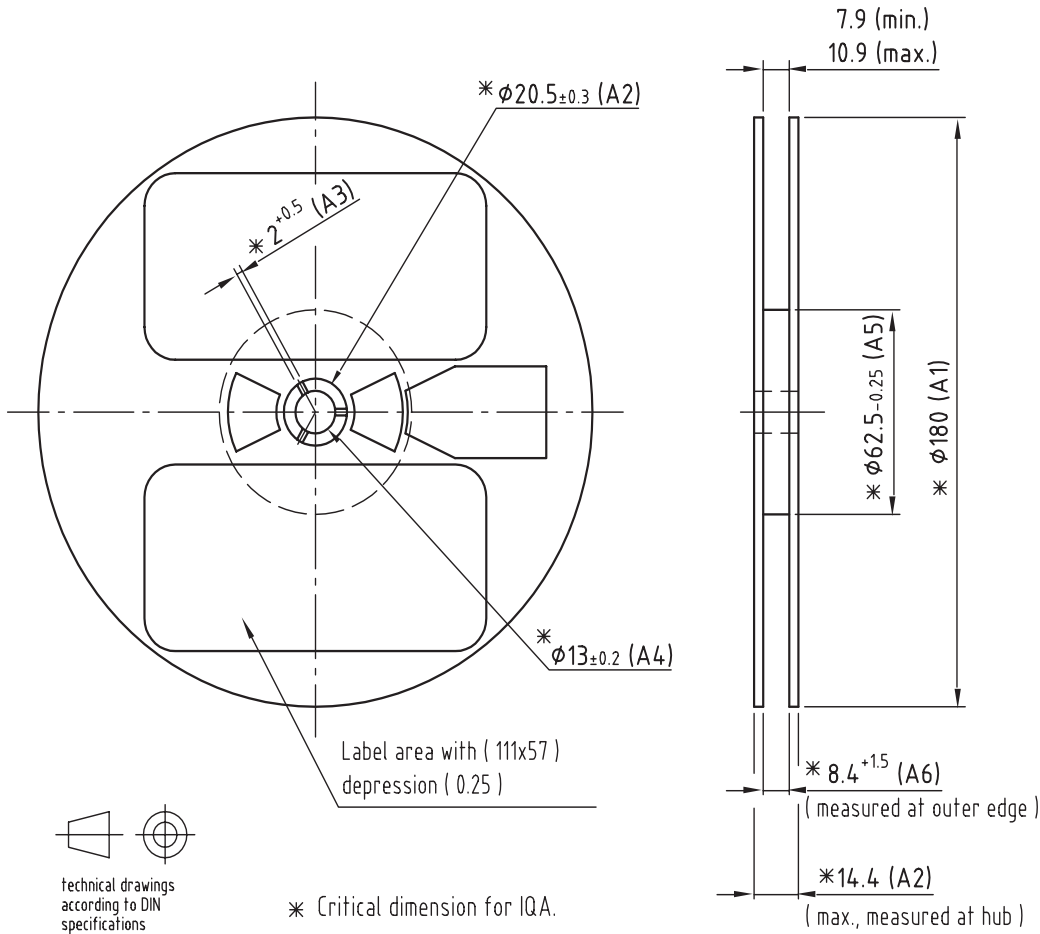

Figure 19. Forward Voltage vs. Ambient Temperature

Reel Dimensions



Drawing-No.: 9.800-5086.01-4
Issue: 1; 29.04.04

Not indicated tolerances ± 0.05
Material: black static dissipative

19043

Tape Dimensions

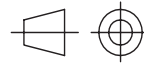
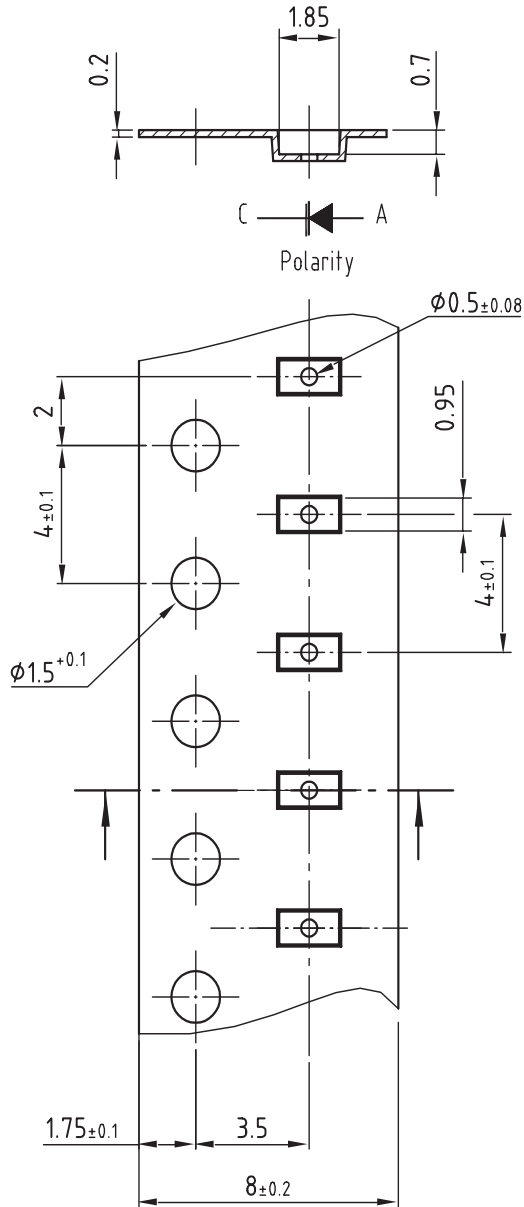

technical drawings
according to DIN
specifications

Dimensions in mm

Not indicated tolerances ± 0.05

Material: Conductive black PC

Drawing-No.: 9.700-5290.01-4

Issue: 1; 29.04.04

19044

Package Dimensions in mm

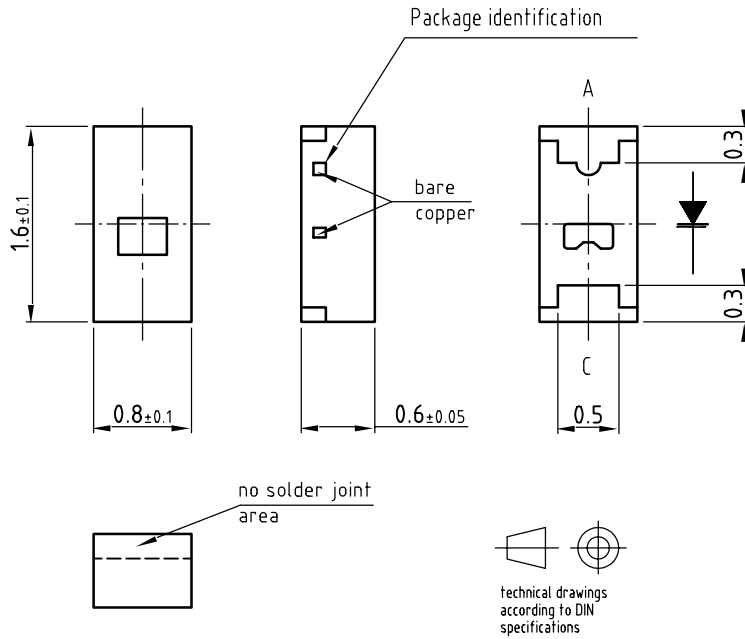

Dimensions in mm

Not indicated tolerances ± 0.1

19426

Recommended solder pad

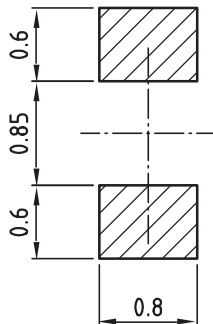

Drawing refers to following types: TLM. 1..

Drawing-No.: 6.541-5056.01-4

Issue: 2; 04.05.05



Ozone Depleting Substances Policy Statement

It is the policy of Vishay Semiconductor GmbH to

1. Meet all present and future national and international statutory requirements.
2. Regularly and continuously improve the performance of our products, processes, distribution and operating systems with respect to their impact on the health and safety of our employees and the public, as well as their impact on the environment.

It is particular concern to control or eliminate releases of those substances into the atmosphere which are known as ozone depleting substances (ODSs).

The Montreal Protocol (1987) and its London Amendments (1990) intend to severely restrict the use of ODSs and forbid their use within the next ten years. Various national and international initiatives are pressing for an earlier ban on these substances.

Vishay Semiconductor GmbH has been able to use its policy of continuous improvements to eliminate the use of ODSs listed in the following documents.

1. Annex A, B and list of transitional substances of the Montreal Protocol and the London Amendments respectively
2. Class I and II ozone depleting substances in the Clean Air Act Amendments of 1990 by the Environmental Protection Agency (EPA) in the USA
3. Council Decision 88/540/EEC and 91/690/EEC Annex A, B and C (transitional substances) respectively.

Vishay Semiconductor GmbH can certify that our semiconductors are not manufactured with ozone depleting substances and do not contain such substances.

We reserve the right to make changes to improve technical design and may do so without further notice.

Parameters can vary in different applications. All operating parameters must be validated for each customer application by the customer. Should the buyer use Vishay Semiconductors products for any unintended or unauthorized application, the buyer shall indemnify Vishay Semiconductors against all claims, costs, damages, and expenses, arising out of, directly or indirectly, any claim of personal damage, injury or death associated with such unintended or unauthorized use.

Vishay Semiconductor GmbH, P.O.B. 3535, D-74025 Heilbronn, Germany



Notice

Specifications of the products displayed herein are subject to change without notice. Vishay Intertechnology, Inc., or anyone on its behalf, assumes no responsibility or liability for any errors or inaccuracies.

Information contained herein is intended to provide a product description only. No license, express or implied, by estoppel or otherwise, to any intellectual property rights is granted by this document. Except as provided in Vishay's terms and conditions of sale for such products, Vishay assumes no liability whatsoever, and disclaims any express or implied warranty, relating to sale and/or use of Vishay products including liability or warranties relating to fitness for a particular purpose, merchantability, or infringement of any patent, copyright, or other intellectual property right.

The products shown herein are not designed for use in medical, life-saving, or life-sustaining applications. Customers using or selling these products for use in such applications do so at their own risk and agree to fully indemnify Vishay for any damages resulting from such improper use or sale.