

TL3240 SERIES TACT SWITCH

ANTI-VANDAL SWITCHES
 DETECTOR SWITCHES
 DIP SWITCHES
 KEYLOCK SWITCHES
 NAVIGATION SWITCHES
 PUSHBUTTON SWITCHES
 ROCKER SWITCHES
 ROTARY SWITCHES
 SLIDE SWITCHES
 SNAP ACTION SWITCHES
TACTILE SWITCHES
 TOGGLE SWITCHES
 CAP OPTIONS

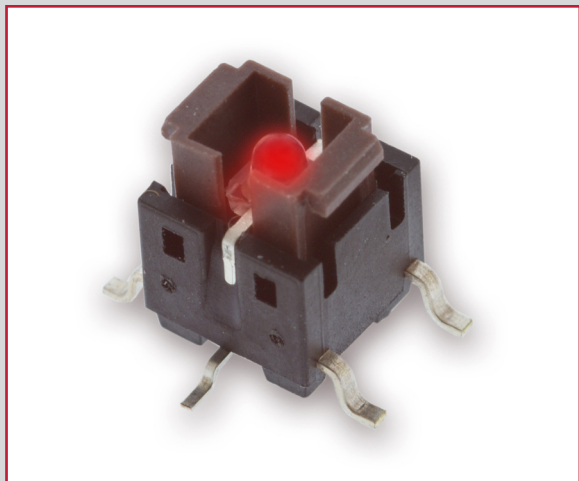

APPLICATIONS / MARKETS

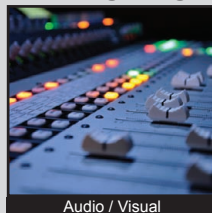

Audio / Visual

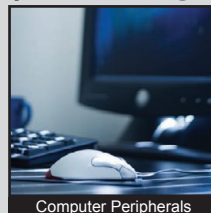

Computer Peripherals



Consumer Electronics

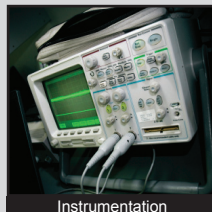

Instrumentation



Telecommunication

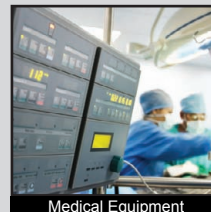

Medical Equipment

RoHS

SPECIFICATIONS

Electrical Rating: 50mA @ 12VDC
Life Expectancy: 200,000 Cycles
Contact Resistance: 100mΩ Max.
Insulation Resistance: 100 MΩ Min. at 500VDC
Dielectric Strength: 250VAC for 1 min.
Operating Temperature: -25°C to 70°C
Storage Temperature: -30°C to 80°C
Operating Force: 100 gf +/- 50 gf; 160 gf +/- 50 gf;
 260 gf +/- 50 gf
Travel: 0.2mm +/- 0.1mm
Contact Arrangement: SPST, Normally Open

FEATURES & BENEFITS

- Illumination options
- Tape & Reel packaging: 450 pieces per reel
- Caps sold separately
- Surface Mount

PART NUMBER CONFIGURATOR

Series	Model	Force	LED	Cap*	Cap Color
TL	3240	F100 - 100 gf F160 - 160 gf F260 - 260 gf	B - Blue R - Red G - Green Y - Yellow	TL3240R1CAP TL3240S1CAP	BLK - Black RED - Red BLU - Blue IVR - Ivory GRN - Green YEL - Yellow

* Cap to be ordered separately. *They cannot go thru the reflow soldering process.*

Specifications subject to change without notice



E-SWITCH®

www.e-switch.com

800.867.2717

2

TL3240 SERIES TACT SWITCH

BODY DIMENSIONS

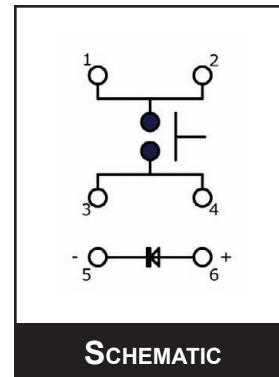
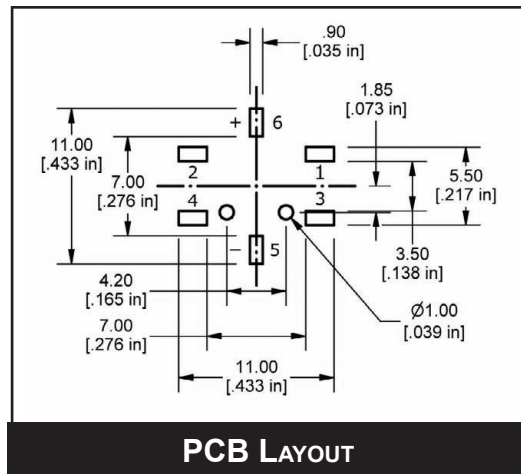
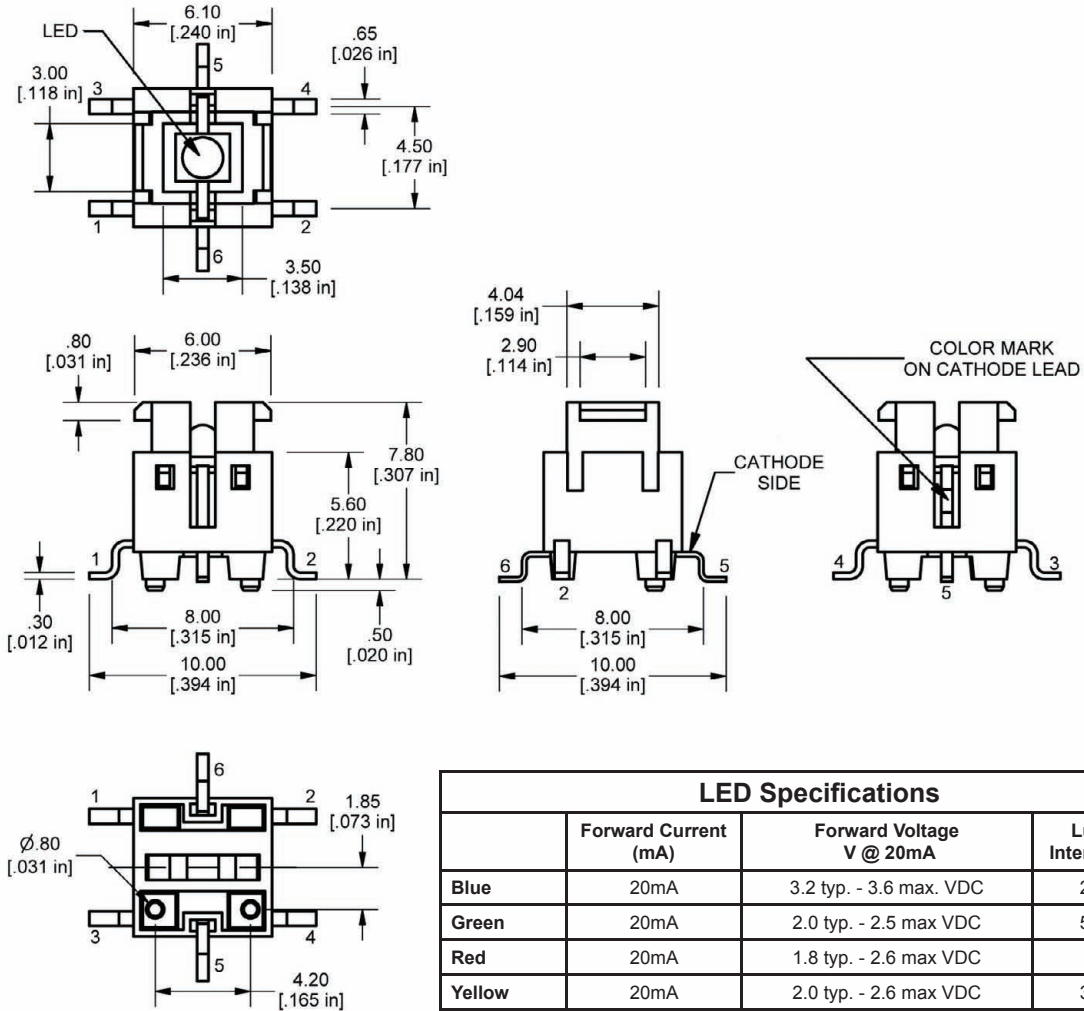

ANTI-VANDAL SWITCHES
 DETECTOR SWITCHES
 DIP SWITCHES
 KEYLOCK SWITCHES
 NAVIGATION SWITCHES
 PUSHBUTTON SWITCHES
 ROCKER SWITCHES
 ROTARY SWITCHES
 SLIDE SWITCHES
 SNAP ACTION SWITCHES
 TACTILE SWITCHES
 TOGGLE SWITCHES
 CAP OPTIONS