

TF Series Miniature Snap-acting Switches

Features/Benefits

- Broad range of operating forces
- Ratings up to 21 AMPS
- Wide variety of actuator styles
- Quick connect terminations

Typical Applications

- Motor controls
- Thermostatics
- Portable tools



Specifications

CONTACT RATING: From low level* to 21 AMPS @ 277 V AC.

ELECTRICAL LIFE: 300,000 cycles at 10 AMPS @ 250 V AC, consult Customer Service Center for typical life of higher rated switches.

INSULATION RESISTANCE: 1,000 M ohm min.

DIELECTRIC STRENGTH: 1,500 Vrms min. @ sea level.

OPERATING TEMPERATURE: -40°F to 185°F (-40°C to 85°C).

OPERATING FORCE: From 15 to 400 grams at actuator button available.

MOUNTING: Torque screws 2-5 in/lbs.

* Low Level=conditions where no arcing occurs during switching, i.e., 0.4 VA max. @ 20 V AC or DC max. Standard electrical life per UL 1054, rated for 6,000 operations.

Materials

SWITCH HOUSING: Thermoplastic (UL 94V-0).

ACTUATOR BUTTON: Thermoplastic (UL 94V-0).

SPRING: Copper alloy.

PIVOT: Brass alloy.

MOVABLE CONTACTS: Gold alloy for ratings 1 AMP or less.

Fine silver for ratings greater than 1 AMP up to 15 AMPS.

Precious metal alloy for ratings greater than 15 AMPS.

STATIONARY CONTACTS: Gold alloy for ratings 1 AMP or less.

Fine silver for ratings greater than 1 AMP.

TERMINALS: Brass alloy for ratings up to 10 AMPS.

Copper alloy for ratings greater than 10 AMPS.

NOTE: Specifications and materials listed above are switches with standard options. For information on specific and custom switches, consult Customer Service Center.

Build-A-Switch

To order, simply select desired option from each category and place in the appropriate box. Available options are shown and described on pages J-6 through J-10. For additional options not shown in catalog, consult Customer Service Center.

<p>Series</p> <p>TF SP, Mom.</p>	<p>Operating Force</p> <p>CJ 5.29 oz./150 grams</p> <p>CC .53 oz./15 grams</p> <p>CD .88 oz./25 grams</p> <p>CF 1.76 oz./50 grams</p> <p>CG 2.65 oz./75 grams</p> <p>EC 7.94 oz./225 grams</p> <p>EE 14.11 oz./400 grams</p>	<p>Electrical Rating</p> <p>J6 15 A, 277 V AC; 1/2 HP, 125, 250 V AC; 5 A, 125 V AC "L"; 0.5 A, 125 V DC; 0.25 A, 250 V DC</p> <p>F5 1 A, 125 V AC; 1 A, 30 V DC</p> <p>H8 5 A, 277 V AC; 1/10 HP, 125, 250 V AC</p> <p>J3 21 A, 277 V AC; 1 HP, 125 V AC; 2 HP, 250 V AC; 5 A, 125 V AC "L"</p> <p>K6 11 A, 277 V AC; 1/3 HP, 125, 250 V AC; 0.5 A, 125 V DC; 0.25 A, 250 V DC</p> <p>L3 20 A, 250 V AC; 1 HP, 125 V AC; 2 HP 250 V AC</p> <p>V1 1 A, 125 V AC; 1 A, 30 V DC (UL/CSA)</p> <p>V2 5 A, 277 V AC; 1/10 HP, 125, 250 V AC (UL/CSA); 5(2) A, 250 V AC (VDE)</p> <p>V3 11 A, 277 V AC; 1/3 HP, 125, 250 V AC; 0.5 A, 125 V DC; 0.25 A, 250 V DC (UL/CSA); 10(3) A, 250 V AC (VDE)</p> <p>V4 21 A, 277 V AC; 1 HP, 125 V AC; 2 HP, 250 V AC; 5 A, 125 V AC "L"; 16(3) A, 250 V AC (VDE)</p>	<p>Mounting Style</p> <p>S Standard</p> <p>V Metric</p>	<p>Actuator</p> <p>P00 Pin plunger</p> <p>A10 .81" lever roller, high force</p> <p>A15 1.34" lever roller, high force</p> <p>A20 1.05" lever roller, low force</p> <p>A25 1.56" lever roller, low force</p> <p>T10 .84" lever, high force</p> <p>T13 1.34" simulated roller, high force</p> <p>T14 1.29" simulated roller, high force</p> <p>T15 1.40" lever, high force</p> <p>T16 2.34" lever, high force</p> <p>T18 2.75" lever, high force</p> <p>T20 1.10" lever, low force</p> <p>T23 1.56" simulated roller, low force</p> <p>T24 1.50" simulated roller, low force</p> <p>T25 1.62" lever, low force</p> <p>T26 2.57" lever, low force</p> <p>T28 2.97" lever, low force</p> <p>WPO Wide pin plunger</p>	<p>Circuitry</p> <p>C SPDT</p> <p>W SPST N.C.</p> <p>Y SPST N.O.</p>	<p>Terminations</p> <p>40 .187" quick connect</p> <p>4A .250" quick connect</p> <p>5A .250" offset quick connect</p> <p>5B .187" offset quick connect</p>
--	--	--	--	---	--	--



Dimensions are shown: Inches (mm)
Specifications and dimensions subject to change

TF Series Miniature Snap-acting Switches

SERIES

TF MINIATURE SNAP-ACTING SWITCHES – SP MOMENTARY

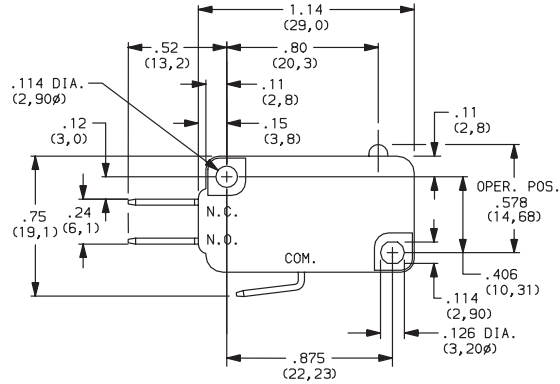
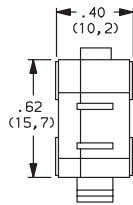

OPERATING FORCE



Snap-acting

OPTION CODE	BASIC SWITCH OPERATING FORCE (OZ./GRAMS)
CC	.53 15
CD	.88 25
CF	1.76 50
CG	2.65 75
CJ	5.29 150
EC	7.94 225
EE*	14.11 400

*Minimums may apply, consult Customer Service Center.

Operating Force option 'CC' not available with 'T18 & T26' Actuator options.
Operating force varies with actuator option, see ACTUATOR option section.

ELECTRICAL RATING

OPTION CODE	RoHS COMPLIANT *	RoHS COMPATIBLE *	CONTACT MATERIAL		ELECTRICAL RATING
			MOVABLE CONTACT	STATIONARY CONTACT	
F5	Yes	Yes	Gold alloy	Gold alloy	From low level* to 1 AMP @ 125 V AC, 1 AMP @ 30 V DC.
H8	Yes	Yes	Fine Silver	Fine Silver	5 AMPS @ 277 V AC; 1/10 HP @ 125 & 250 V AC.
J3	Yes	Yes			21 AMPS @ 277 V AC; 1 HP @ 125 V AC; 2 HP @ 250 V AC; 5 AMPS @ 125 V AC "L".
J6	Yes	Yes			15 AMPS @ 277 V AC; 1/2 HP @ 125 & 250 V AC; 5 AMPS @ 125 V AC "L". 0.5 AMP @ 125 V DC; 0.25 AMP @ 250 V DC.
K6	Yes	Yes			11 AMPS @ 277 V AC; 1/3 HP @ 125 & 250 V AC; 0.5 AMP @ 125 V DC; 0.25 AMP @ 250 V DC.
L3	Yes	Yes	Silver alloy		20 AMPS @ 250 V AC; 1 HP @ 125 V AC; 2 HP @ 250 V AC

* Note: See Technical Data section of this catalog for RoHS compliant and compatible definitions and specifications.

All models with all options, .

Consult Customer Service center for availability and delivery of nonstandard ratings.

* Low Level=conditions where no arcing occurs during switching, i.e., 0.4 VA max. @ 20 V AC or DC max.





Dimensions are shown: Inch (mm)

Specifications and dimensions subject to change



TF Series Miniature Snap-acting Switches

ELECTRICAL RATING

OPTION CODE	RoHS COMPLIANT	RoHS COMPATIBLE	CONTACT MATERIAL		INTERNATIONAL ELECTRICAL RATING   
			MOVABLE CONTACT	STATIONARY CONTACT	
V1	Yes	Yes	Gold alloy	Gold alloy	From low level* to 1 AMP @ 125 V AC; 1 AMP @ 30 V DC (UL/CSA). 0.1 (0.05) AMP @ 250 V-μ T85 50E3 (VDE).
V2	Yes	Yes	Fine Silver	Fine Silver	5 AMPS @ 277 V AC; 1/10 HP @ 125 & 250 V AC (UL/CSA). 5 (2) AMPS @ 250 V-μ T85 50E3 (VDE).
V3	Yes	Yes			11 AMPS @ 277 V AC; 1/3 HP @ 125 & 250 V AC; 0.5 AMP @ 125 V DC; 0.25 AMP @ 250 V DC (UL/CSA). 10 (3) AMPS @ 250 V-μ 50E3 T85 (VDE).
V4	Yes	Yes	Precious metal alloy		21 AMPS @ 277 V AC; 1 HP @ 125 V AC; 2 HP @ 250 V AC; 16 (3) AMPS @ 250 V-μ T85 10E3 (VDE).

* Note: See Technical Data section of this catalog for RoHS compliant and compatible definitions and specifications.

NOTE: V1-V4 ratings available with '5A or 5B' terminal styles only.

INTERNATIONAL RATING SYMBOLS	
μ	Microgap construction (less than 3 mm).
~	Alternating current.
T _{max}	Maximum rated use temperature.
50E3	Cycles over 50,000 at rated current.
10E3	Cycles over 10,000 at rated current.
10(3)	Current Rating: First number represents resistive rating; second number represents inductive (motor) rating.

ELECTRICAL RATING	AMPS (REF.)	OPERATING FORCE						
		CC (15)	CD (25)	CF (50)	CG (75)	CJ (150)	EC (225)	EE (400)
F5	1	•	•	•	•	•	•	
H8	5	•	•	•	•	•	•	•
J3	21	X	X	X	X	•	•	•
J6	15	X	X	X	X	•	•	•
K6	11	X	•	•	•	•	•	•
L3	20	X	X	X	X	•	•	•
V1	1	•	•	•	•	•	X	X
V2	5	X	X	•	•	•	•	•
V3	11	X	X	X	•	•	•	•
V4	16	X	X	X	X	•	•	•

All models   with all options, .

Consult Customer Service center for availability and delivery of nonstandard ratings.

* Low Level=conditions where no arcing occurs during switching, i.e., 0.4 VA max. @ 20 V AC or DC max.

• AVAILABLE

X NOT AVAILABLE

** Available with 4A & 5A terminations only, see page J-10.



Snap-acting

MOUNTING STYLE

S STANDARD
For 4-40 screw size

V Metric
For 3 mm screw size

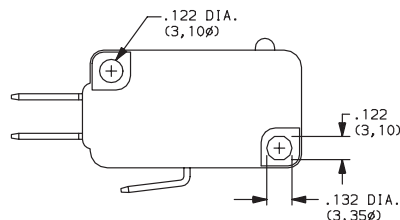
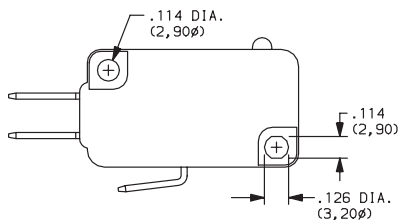

Third Angle Projection

Dimensions are shown: Inches (mm)
Specifications and dimensions subject to change



TF Series Miniature Snap-acting Switches

ACTUATOR 

OPTION CODE	FIG.	DIM. A	DIM. B	DIM. C	DIM. D
P00	1	.80 (20,3)	—	.578 ± .015 (14,68 ± 0,38)	—
A10	2	.81 (20,6)	.32 (8,1)	.810 ± .020 (20,57 ± 0,51)	.19 dia. (4,80)
A15	2	1.34 (34,0)	.32 (8,1)	.810 ± .030 (20,57 ± 0,76)	.19 dia. (4,80)
A20	2	1.05 (26,7)	.54 (13,7)	.810 ± .050 (20,57 ± 1,27)	.19 dia. (4,80)
A25	2	1.56 (39,6)	.54 (13,7)	.810 ± .075 (20,57 ± 1,91)	.19 dia. (4,80)
T10	3	.84 (21,3)	.32 (8,1)	.600 ± .020 (15,24 ± 0,51)	—
T15	3	1.40 (35,6)	.32 (8,1)	.600 ± .040 (15,24 ± 1,02)	—
T16	3	2.34 (59,4)	.32 (8,1)	.600 ± .065 (15,24 ± 1,65)	—
T18	3	2.75 (69,9)	.32 (8,1)	.600 ± .080 (15,24 ± 2,03)	—
T20	3	1.10 (27,9)	.54 (13,7)	.600 ± .050 (15,24 ± 1,27)	—
T25	3	1.62 (41,1)	.54 (13,7)	.600 ± .070 (15,24 ± 1,78)	—
T26	3	2.57 (65,3)	.54 (13,7)	.600 ± .150 (15,24 ± 3,81)	—
T28	3	2.97 (75,4)	.54 (13,7)	.600 ± .187 (15,24 ± 4,75)	—
T13	4	1.34 (34,0)	.32 (8,1)	.810 ± .030 (20,57 ± 0,76)	.19 dia. (4,80)
T14	4	1.29 (32,8)	.32 (8,1)	.730 ± .030 (18,54 ± 0,76)	.19 dia. (6,40)
T23	4	1.56 (39,6)	.54 (13,7)	.810 ± .065 (20,57 ± 1,65)	.19 dia. (4,80)
T24	4	1.50 (38,1)	.54 (13,9)	.730 ± .060 (18,54 ± 1,52)	.25 dia. (6,40)
WP0	5	.80 (20,3)	—	.635 ± .015 (16,13 ± 0,38)	—

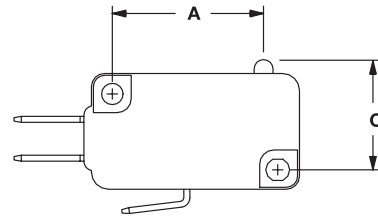

FIG. 1
Pin Plunger

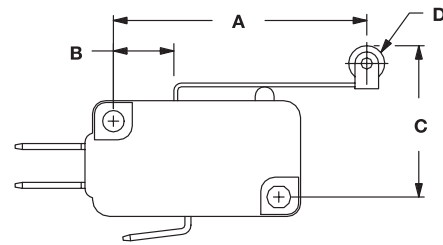

FIG. 2
Lever Roller

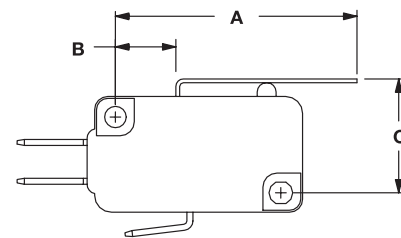

FIG. 3
Lever

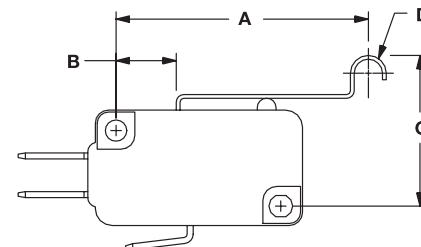

FIG. 4
Simulated Roller

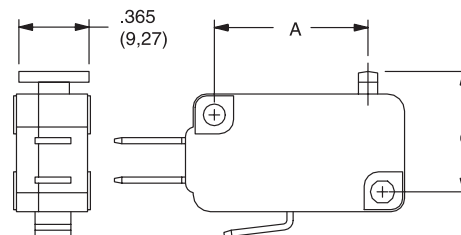

FIG. 5
Wide Pin



Third Angle
Projection

Dimensions are shown: Inch (mm)
Specifications and dimensions subject to change

NOTE: Switch characteristics chart on following page.

Snap-acting



TF Series Miniature Snap-acting Switches

ACTUATOR

SWITCH CHARACTERISTICS

OPTION CODE	MAXIMUM OPERATING FORCE (OZ./GRAMS)							MINIMUM RELEASE FORCE (OZ./GRAMS)							MAXIMUM DIFFERENTIAL TRAVEL	MAXIMUM PRETRAVEL	MINIMUM OVERTRAVEL
	CC	CD	CF	CG	CJ	EC	EE	CC	CD	CF	CG	CJ	EC	EE	ALL FORCES	ALL FORCES	ALL FORCES
	(15)	(25)	(50)	(75)	(150)	(225)	(400)	(15)	(25)	(50)	(75)	(150)	(225)	(400)			
A10	.63 18	1.06 30	2.29 65	3.17 90	6.35 180	7.94 225	14.11 400	.21 6	.35 10	.35 10	.53 15	.71 20	1.98 56	3.88 110	.015 (0,38)	.060 (1,52)	.030 (0,76)
A15	.28 8	.42 12	1.06 30	1.59 45	3 85	4.59 130	7.94 225	.07 2	.14 4	.14 4	.18 5	.35 10	.71 20	2.82 80	.030 (0,76)	.100 (2,54)	.065 (1,65)
A20	0.53 15	0.71 20	1.41 40	2.12 60	4.23 120	6 170	9.7 275	0.07 2	0.11 3	0.11 3	0.18 5	0.42 12	0.71 20	1.41 40	0.025 (0,64)	0.12 (3,05)	0.055 (1,40)
A25	.18 5	.28 8	.56 16	.85 24	1.69 48	2.65 75	4.41 125	.04 1	.07 2	.07 2	.07 2	.21 6	.35 10	.71 20	.050 (1,27)	.250 (6,35)	.120 (3,05)
P00	.53 15	.88 25	1.76 50	2.65 75	5.29 150	7.94 225	14.11 400	.21 6	.35 10	.35 10	.53 15	1.23 35	1.98 56	3.88 110	.010 (0,25)	.047 (1,19)	.050 (1,27)
T10	.63 18	1.06 30	2.29 65	3.17 90	6.35 180	7.94 225	14.11 400	.21 6	.35 10	.35 10	.53 15	.71 20	1.98 56	3.88 110	.015 (0,38)	.060 (1,52)	.030 (0,76)
T13	.28 8	.42 12	1.06 30	1.59 45	3 85	4.59 130	7.94 225	.07 2	.14 4	.14 4	.18 5	.35 10	.71 20	2.82 80	.030 (0,76)	.100 (2,54)	.065 (1,65)
T14	.28 8	.42 12	1.23 35	1.76 50	3.17 90	4.76 135	7.94 225	.07 2	.14 4	.14 4	.18 5	.35 10	.71 20	2.82 80	.030 (0,76)	.100 (2,54)	.060 (1,52)
T15	.25 7	.42 12	1.06 30	1.41 40	2.82 80	4.41 125	7.94 225	.07 2	.14 4	.14 4	.18 5	.28 8	.63 18	2.82 80	.030 (0,76)	.110 (2,59)	.065 (1,65)
T16	.18 5	.28 8	.53 15	.78 22	1.59 45	2.47 70	4.23 120	.04 1	.07 2	.07 2	.07 2	.28 8	.35 10	.71 20	.045 (1,14)	.250 (6,35)	.125 (3,18)
T18	N/A	.21 6	.42 12	.71 20	1.41 40	2.12 60	3.53 100	N/A	.04 1	.04 1	.07 2	.18 5	.28 8	.56 16	.062 (1,57)	.300 (7,62)	.155 (3,94)
T20	.53 15	.71 20	1.41 40	2.12 60	4.23 120	6 170	9.70 275	.21 6	.35 10	.35 10	.53 15	.71 20	1.98 56	3.88 110	.030 (0,76)	.140 (3,56)	.060 (1,52)
T23	.18 5	.28 8	.56 16	.85 24	1.69 48	2.65 75	4.41 125	.04 1	.07 2	.07 2	.07 2	.21 6	.35 10	.71 20	.050 (1,27)	.250 (6,35)	.120 (3,05)
T24	0.18 5	0.28 8	0.56 16	0.88 25	1.76 50	2.65 75	4.76 135	0.04 1	0.07 2	0.07 2	0.11 3	0.21 6	0.35 10	0.71 20	.005 (1,27)	0.23 (5,84)	0.11 (2,79)
T25	.18 5	.28 8	.53 15	.88 25	1.59 45	2.47 70	4.23 120	.04 1	.07 2	.07 2	.07 2	.21 6	.35 10	.99 28	.055 (1,40)	.250 (6,35)	.125 (3,18)
T26	N/A	.14 4	.28 8	.42 12	.85 24	1.27 36	2.26 64	N/A	.04 1	.04 1	.05 1.5	.12 3.5	.21 6	.39 11	.100 (2,54)	.500 (12,70)	.235 (5,97)
T28	N/A	N/A	N/A	0.42 12	0.71 20	1.06 30	1.94 55	N/A	N/A	N/A	0.04 1	0.11 3	0.18 5	0.32 9	0.12 (3,05)	.056 (14,22)	0.285 (7,24)
WP0	.53 15	.88 25	1.76 50	2.65 75	5.29 150	7.94 225	14.11 400	.21 6	.35 10	.35 10	.53 15	1.23 35	1.97 56	3.88 110	.010 (0,25)	.047 (1,19)	.030 (0,51)

NOTE: For basic switch operating forces, see page J-6.

HIGH FORCE, LOW MOTION PIVOT POSITION

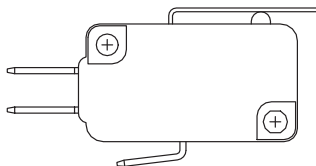

Available with actuators A10, A15, T10, T13, T14, T15, T16 and T18.

LOW FORCE, HIGH MOTION PIVOT POSITION

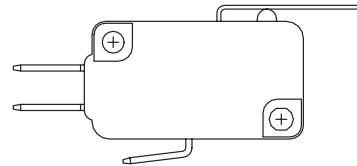

Available with actuators A20, A25, T20, T23, T24, T25, T26, and T28.

NOTE: Lever actuator options are available in either of two pivot positions. Levers located in the forward pivot position have lower forces and higher motions. Levers located in the rear pivot position have higher forces and lower motions.



Third Angle
Projection

Dimensions are shown: Inches (mm)
Specifications and dimensions subject to change



Snap-acting

TF Series Miniature Snap-acting Switches

TERMINATIONS

40 .187" QUICK CONNECT

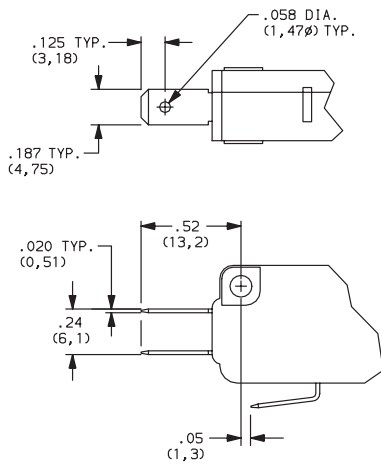

4A .250" QUICK CONNECT

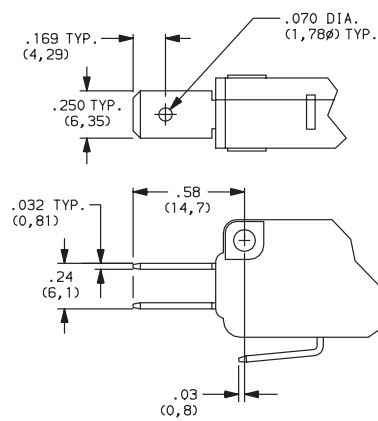

5A OFFSET .250" QUICK CONNECT

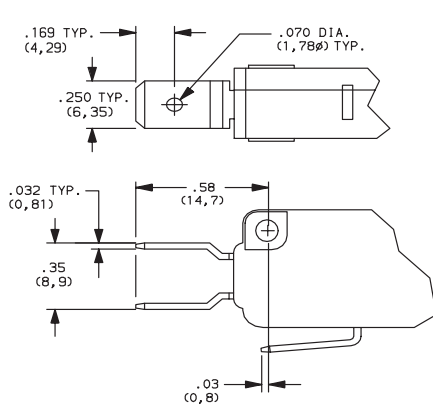

5B OFFSET .187" QUICK CONNECT

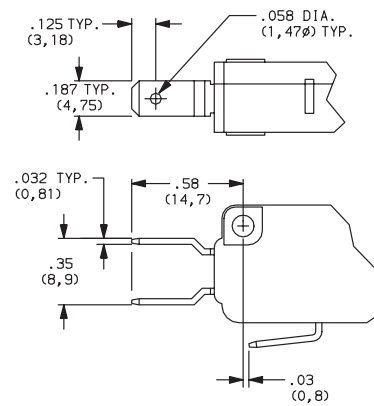

CIRCUITRY

- C** SPDT (Single Pole, Double Throw)
- W** SPST N.C. (Single Pole, Single Throw, Normally Closed)
- Y** SPST N.O. (Single Pole, Single Throw, Normally Open)



Third Angle
Projection

Dimensions are shown: Inch (mm)
Specifications and dimensions subject to change