

TF Series Miniature Snap-acting Switches

Features/Benefits

- Broad range of operating forces
- Ratings up to 21 AMPS
- Wide variety of actuator styles
- Quick connect terminations

Typical Applications

- Motor controls
- Thermostatics
- Portable tools



Specifications

CONTACT RATING: From low level* to 21 AMPS @ 277 V AC.
 ELECTRICAL LIFE: 300,000 cycles at 10 AMPS @ 250 V AC, consult Customer Service Center for typical life of higher rated switches.
 INSULATION RESISTANCE: 1,000 M ohm min.
 DIELECTRIC STRENGTH: 1,500 Vrms min. @ sea level.
 OPERATING TEMPERATURE: -40°F to 185°F (-40°C to 85°C).
 OPERATING FORCE: From 15 to 400 grams at actuator button available.
 MOUNTING: Torque screws 2-5 in/lbs.

* Low Level=conditions where no arcing occurs during switching, i.e., 0.4 VA max. @ 20 V AC or DC max. Standard electrical life per UL 1054, rated for 6,000 operations.

Materials

SWITCH HOUSING: Thermoplastic (UL 94V-0).
 ACTUATOR BUTTON: Thermoplastic (UL 94V-0).
 SPRING: Copper alloy.
 PIVOT: Brass alloy.
 MOVABLE CONTACTS: Gold alloy for ratings 1 AMP or less.
 Fine silver for ratings greater than 1 AMP up to 15 AMPS.
 Precious metal alloy for ratings greater than 15 AMPS.
 STATIONARY CONTACTS: Gold alloy for ratings 1 AMP or less.
 Fine silver for ratings greater than 1 AMP.
 TERMINALS: Brass alloy for ratings up to 10 AMPS.
 Copper alloy for ratings greater than 10 AMPS.

NOTE: Specifications and materials listed above are switches with standard options. For information on specific and custom switches, consult Customer Service Center.

Build-A-Switch

To order, simply select desired option from each category and place in the appropriate box. Available options are shown and described on pages J-6 through J-10. For additional options not shown in catalog, consult Customer Service Center.

<p>Series TF SP, Mom.</p> <p>Operating Force CJ 5.29 oz./150 grams CC .53 oz./15 grams CD .88 oz./25 grams CF 1.76 oz./50 grams CG 2.65 oz./75 grams EC 7.94 oz./225 grams EE 14.11 oz./400 grams</p> <p>Electrical Rating J6 15 A, 277 V AC; 1/2 HP, 125, 250 V AC; 5 A, 125 V AC "L"; 0.5 A, 125 V DC; 0.25 A, 250 V DC F5 1 A, 125 V AC; 1 A, 30 V DC H8 5 A, 277 V AC; 1/10 HP, 125, 250 V AC J3 21 A, 277 V AC; 1 HP, 125 V AC; 2 HP, 250 V AC; 5 A, 125 V AC "L" K6 11 A, 277 V AC; 1/3 HP, 125, 250 V AC; 0.5 A, 125 V DC; 0.25 A, 250 V DC L3 20 A, 250 V AC; 1 HP, 125 V AC; 2 HP 250 V AC V1 1 AMP @ 125 V AC; 1 AMP @ 30 V DC (UL/CSA); 0.1 (0.05) AMP @ 250 V~μ T85 50E3 (VDE) V2 5 A, 277 V AC; 1/10 HP, 125, 250 V AC (UL/CSA); 5(2) A, 250 V AC (VDE) V3 11 A, 277 V AC; 1/3 HP, 125, 250 V AC; 0.5 A, 125 V DC; 0.25 A, 250 V DC (UL/CSA); 10(3) A, 250 V AC (VDE) V4 21 A, 277 V AC; 1 HP, 125 V AC; 2 HP, 250 V AC; 5 A, 125 V AC "L"; 16(3) A, 250 V AC (VDE)</p>	<p>Mounting Style S Standard V Metric</p> <p>Actuator P00 Pin plunger A10 .81" lever roller, high force A15 1.34" lever roller, high force A20 1.05" lever roller, low force A25 1.56" lever roller, low force T10 .84" lever, high force T13 1.34" simulated roller, high force T14 1.29" simulated roller, high force T15 1.40" lever, high force T16 2.34" lever, high force T18 2.75" lever, high force T20 1.10" lever, low force T23 1.56" simulated roller, low force T24 1.50" simulated roller, low force T25 1.62" lever, low force T26 2.57" lever, low force T28 2.97" lever, low force WPO Wide pin plunger</p>	<p>Circuitry C SPDT W SPST N.C. Y SPST N.O.</p> <p>Terminations 40 .187" quick connect 4A .250" quick connect 5A .250" offset quick connect 5B .187" offset quick connect</p>
---	--	---



Dimensions are shown: Inches (mm)
 Specifications and dimensions subject to change

TF Series Miniature Snap-acting Switches

SERIES

TF MINIATURE SNAP-ACTING SWITCHES – SP MOMENTARY

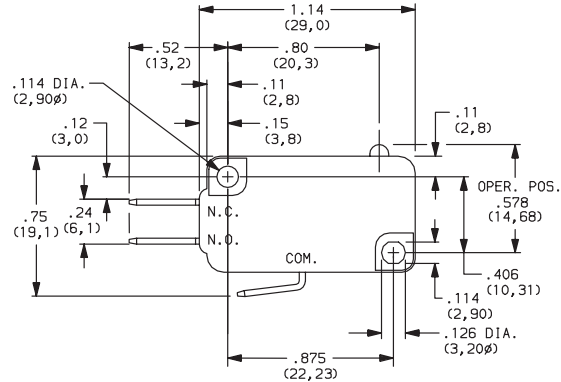
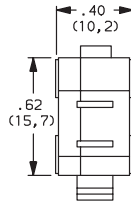

OPERATING FORCE



Snap-acting

OPTION CODE	BASIC SWITCH OPERATING FORCE (OZ./GRAMS)
CC	.53 15
CD	.88 25
CF	1.76 50
CG	2.65 75
CJ	5.29 150
EC	7.94 225
EE	14.11 400

*Minimums may apply, consult Customer Service Center.

Operating Force option 'CC' not available with 'T18 & T26' Actuator options.
Operating force varies with actuator option, see ACTUATOR option section.

ELECTRICAL RATING

OPTION CODE	RoHS COMPLIANT *	RoHS COMPATIBLE *	CONTACT MATERIAL		ELECTRICAL RATING
			MOVABLE CONTACT	STATIONARY CONTACT	
F5	Yes	Yes	Gold alloy	Gold alloy	From low level* to 1 AMP @ 125 V AC, 1 AMP @ 30 V DC.
H8	Yes	Yes	Fine Silver	Fine Silver	5 AMPS @ 277 V AC; 1/10 HP @ 125 & 250 V AC.
J3	Yes	Yes			21 AMPS @ 277 V AC; 1 HP @ 125 V AC; 2 HP @ 250 V AC; 5 AMPS @ 125 V AC "L".
J6	Yes	Yes			15 AMPS @ 277 V AC; 1/2 HP @ 125 & 250 V AC; 5 AMPS @ 125 V AC "L". 0.5 AMP @ 125 V DC; 0.25 AMP @ 250 V DC.
K6	Yes	Yes			11 AMPS @ 277 V AC; 1/3 HP @ 125 & 250 V AC; 0.5 AMP @ 125 V DC; 0.25 AMP @ 250 V DC.
L3	Yes	Yes	Silver alloy		20 AMPS @ 250 V AC; 1 HP @ 125 V AC; 2 HP @ 250 V AC

* Note: See Technical Data section of this catalog for RoHS compliant and compatible definitions and specifications.

All models specific options .

Consult Customer Service center for availability and delivery of nonstandard ratings.

* Low Level=conditions where no arcing occurs during switching, i.e., 0.4 VA max. @ 20 V AC or DC max.





Third Angle Projection

Dimensions are shown: Inch (mm)
Specifications and dimensions subject to change



TF Series Miniature Snap-acting Switches

ELECTRICAL RATING



OPTION CODE	RoHS COMPLIANT	RoHS COMPATIBLE	CONTACT MATERIAL		INTERNATIONAL ELECTRICAL RATING  
			MOVABLE CONTACT	STATIONARY CONTACT	
V1	Yes	Yes	Gold alloy	Gold alloy	From low level* to 1 AMP @ 125 V AC; 1 AMP @ 30 V DC (UL/CSA). 0.1 (0.05) AMP @ 250 V-μ T85 50E3 (VDE).
V2	Yes	Yes	Fine Silver	Fine Silver	5 AMPS @ 277 V AC; 1/10 HP @ 125 & 250 V AC (UL/CSA). 5 (2) AMPS @ 250 V-μ T85 50E3 (VDE).
V3	Yes	Yes			11 AMPS @ 277 V AC; 1/3 HP @ 125 & 250 V AC; 0.5 AMP @ 125 V DC; 0.25 AMP @ 250 V DC (UL/CSA). 10 (3) AMPS @ 250 V-μ 50E3 T85 (VDE).
V4	Yes	Yes	Precious metal alloy		21 AMPS @ 277 V AC; 1 HP @ 125 V AC; 2 HP @ 250 V AC; 16 (3) AMPS @ 250 V-μ T85 10E3 (VDE).

* Note: See Technical Data section of this catalog for RoHS compliant and compatible definitions and specifications.

NOTE: V1-V4 ratings available with '5A or 5B' terminal styles only.

INTERNATIONAL RATING SYMBOLS	
μ	Microgap construction (less than 3 mm).
~	Alternating current.
T _{max}	Maximum rated use temperature.
50E3	Cycles over 50,000 at rated current.
10E3	Cycles over 10,000 at rated current.
10(3)	Current Rating: First number represents resistive rating; second number represents inductive (motor) rating.

ELECTRICAL RATING	AMPS (REF.)	OPERATING FORCE						
		CC (15)	CD (25)	CF (50)	CG (75)	CJ (150)	EC (225)	EE (400)
F5	1	•	•	•	•	•	•	
H8	5	•	•	•	•	•	•	•
J3	21	X	X	X	X	•	•	•
J6	15	X	X	X	X	•	•	•
K6	11	X	•	•	•	•	•	•
L3	20	X	X	X	X	•	•	•
V1	1	•	•	•	•	•	X	X
V2	5	X	X	•	•	•	•	•
V3	11	X	X	X	•	•	•	•
V4	16	X	X	X	X	•	•	•

All models  specific options .

Consult Customer Service center for availability and delivery of nonstandard ratings.

* Low Level=conditions where no arcing occurs during switching, i.e., 0.4 VA max. @ 20 V AC or DC max.

• AVAILABLE

X NOT AVAILABLE

** Available with 4A & 5A terminations only, see page J-10.

MOUNTING STYLE

S STANDARD
For 4-40 screw size

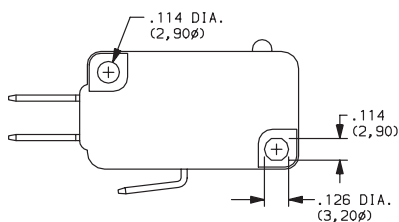

V Metric
For 3 mm screw size

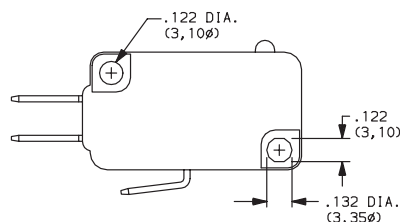

Third Angle
Projection

Dimensions are shown: Inches (mm)
Specifications and dimensions subject to change

C&K

TF Series Miniature Snap-acting Switches

ACTUATOR

OPTION CODE	FIG.	DIM. A	DIM. B	DIM. C	DIM. D
P00	1	.80 (20,3)	—	.578 ± .015 (14,68 ± 0,38)	—
A10	2	.81 (20,6)	.32 (8,1)	.810 ± .020 (20,57 ± 0,51)	.19 dia. (4,80)
A15	2	1.34 (34,0)	.32 (8,1)	.810 ± .030 (20,57 ± 0,76)	.19 dia. (4,80)
A20	2	1.05 (26,7)	.54 (13,7)	.810 ± .050 (20,57 ± 1,27)	.19 dia. (4,80)
A25	2	1.56 (39,6)	.54 (13,7)	.810 ± .075 (20,57 ± 1,91)	.19 dia. (4,80)
T10	3	.84 (21,3)	.32 (8,1)	.600 ± .020 (15,24 ± 0,51)	—
T15	3	1.40 (35,6)	.32 (8,1)	.600 ± .040 (15,24 ± 1,02)	—
T16	3	2.34 (59,4)	.32 (8,1)	.600 ± .065 (15,24 ± 1,65)	—
T18	3	2.75 (69,9)	.32 (8,1)	.600 ± .080 (15,24 ± 2,03)	—
T20	3	1.10 (27,9)	.54 (13,7)	.600 ± .050 (15,24 ± 1,27)	—
T25	3	1.62 (41,1)	.54 (13,7)	.600 ± .070 (15,24 ± 1,78)	—
T26	3	2.57 (65,3)	.54 (13,7)	.600 ± .150 (15,24 ± 3,81)	—
T28	3	2.97 (75,4)	.54 (13,7)	.600 ± .187 (15,24 ± 4,75)	—
T13	4	1.34 (34,0)	.32 (8,1)	.810 ± .030 (20,57 ± 0,76)	.19 dia. (4,80)
T14	4	1.29 (32,8)	.32 (8,1)	.730 ± .030 (18,54 ± 0,76)	.19 dia. (6,40)
T23	4	1.56 (39,6)	.54 (13,7)	.810 ± .065 (20,57 ± 1,65)	.19 dia. (4,80)
T24	4	1.50 (38,1)	.54 (13,7)	.730 ± .060 (18,54 ± 1,52)	.25 dia. (6,40)
WP0	5	.80 (20,3)	—	.635 ± .015 (16,13 ± 0,38)	—

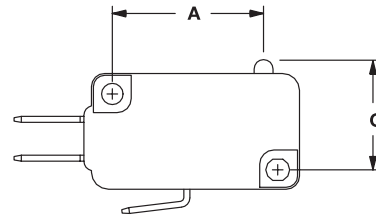

FIG. 1
Pin Plunger

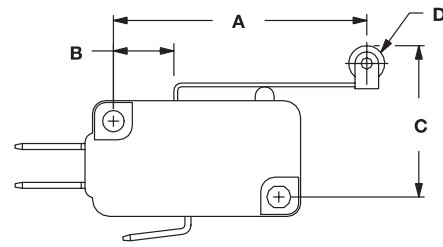

FIG. 2
Lever Roller

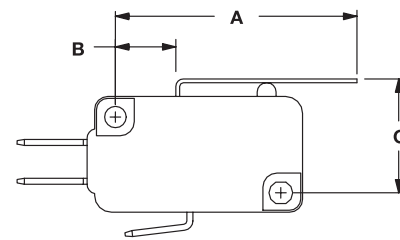

FIG. 3
Lever

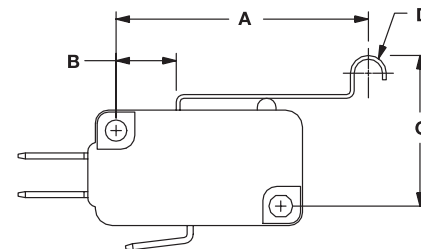

FIG. 4
Simulated Roller

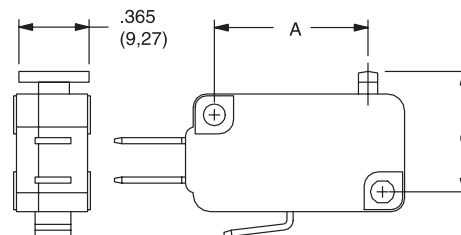

FIG. 5
Wide Pin



Third Angle
Projection

Dimensions are shown: Inch (mm)
Specifications and dimensions subject to change



TF Series Miniature Snap-acting Switches

ACTUATOR

SWITCH CHARACTERISTICS

OPTION CODE	MAXIMUM OPERATING FORCE (OZ./GRAMS)							MINIMUM RELEASE FORCE (OZ./GRAMS)							MAXIMUM DIFFERENTIAL TRAVEL	MAXIMUM PRETRAVEL	MINIMUM OVERTRAVEL
	CC (15)	CD (25)	CF (50)	CG (75)	CJ (150)	EC (225)	EE (400)	CC (15)	CD (25)	CF (50)	CG (75)	CJ (150)	EC (225)	EE (400)	ALL FORCES	ALL FORCES	ALL FORCES
A10	.63 18	1.06 30	2.29 65	3.17 90	6.35 180	7.94 225	14.11 400	.21 6	.35 10	.35 10	.53 15	.71 20	1.98 56	3.88 110	.015 (0,38)	.060 (1,52)	.030 (0,76)
A15	.28 8	.42 12	1.06 30	1.59 45	3 85	4.59 130	7.94 225	.07 2	.14 4	.14 4	.18 5	.35 10	.71 20	2.82 80	.030 (0,76)	.100 (2,54)	.065 (1,65)
A20	0.53 15	0.71 20	1.41 40	2.12 60	4.23 120	6 170	9.7 275	0.07 2	0.11 3	0.11 3	0.18 5	0.42 12	0.71 20	1.41 40	0.025 (0,64)	0.12 (3,05)	0.055 (1,40)
A25	.18 5	.28 8	.56 16	.85 24	1.69 48	2.65 75	4.41 125	.04 1	.07 2	.07 2	.07 2	.21 6	.35 10	.71 20	.050 (1,27)	.250 (6,35)	.120 (3,05)
P00	.53 15	.88 25	1.76 50	2.65 75	5.29 150	7.94 225	14.11 400	.21 6	.35 10	.35 10	.53 15	1.23 35	1.98 56	3.88 110	.010 (0,25)	.047 (1,19)	.050 (1,27)
T10	.63 18	1.06 30	2.29 65	3.17 90	6.35 180	7.94 225	14.11 400	.21 6	.35 10	.35 10	.53 15	.71 20	1.98 56	3.88 110	.015 (0,38)	.060 (1,52)	.030 (0,76)
T13	.28 8	.42 12	1.06 30	1.59 45	3 85	4.59 130	7.94 225	.07 2	.14 4	.14 4	.18 5	.35 10	.71 20	2.82 80	.030 (0,76)	.100 (2,54)	.065 (1,65)
T14	.28 8	.42 12	1.23 35	1.76 50	3.17 90	4.76 135	7.94 225	.07 2	.14 4	.14 4	.18 5	.35 10	.71 20	2.82 80	.030 (0,76)	.100 (2,54)	.060 (1,52)
T15	.25 7	.42 12	1.06 30	1.41 40	2.82 80	4.41 125	7.94 225	.07 2	.14 4	.14 4	.18 5	.28 8	.63 18	2.82 80	.030 (0,76)	.110 (2,79)	.065 (1,65)
T16	.18 5	.28 8	.53 15	.78 22	1.59 45	2.47 70	4.23 120	.04 1	.07 2	.07 2	.07 2	.28 8	.35 10	.71 20	.045 (1,14)	.250 (6,35)	.125 (3,18)
T18	N/A	.21 6	.42 12	.71 20	1.41 40	2.12 60	3.53 100	N/A	.04 1	.04 1	.07 2	.18 5	.28 8	.56 16	.062 (1,57)	.300 (7,62)	.155 (3,94)
T20	.53 15	.71 20	1.41 40	2.12 60	4.23 120	6 170	9.70 275	.21 6	.35 10	.35 10	.53 15	.71 20	1.98 56	3.88 110	.030 (0,76)	.140 (3,56)	.060 (1,52)
T23	.18 5	.28 8	.56 16	.85 24	1.69 48	2.65 75	4.41 125	.04 1	.07 2	.07 2	.07 2	.21 6	.35 10	.71 20	.050 (1,27)	.250 (6,35)	.120 (3,05)
T24	0.18 5	0.28 8	0.56 16	0.88 25	1.76 50	2.65 75	4.76 135	0.04 1	0.07 2	0.07 2	0.11 3	0.21 6	0.35 10	0.71 20	.005 (1,27)	0.23 (5,84)	0.11 (2,79)
T25	.18 5	.28 8	.53 15	.88 25	1.59 45	2.47 70	4.23 120	.04 1	.07 2	.07 2	.07 2	.21 6	.35 10	.99 28	.055 (1,40)	.250 (6,35)	.125 (3,18)
T26	N/A	.14 4	.28 8	.42 12	.85 24	1.27 36	2.26 64	N/A	.04 1	.04 1	.05 1.5	.12 3.5	.21 6	.39 11	.100 (2,54)	.500 (12,70)	.235 (5,97)
T28	N/A	N/A	N/A	0.42 12	0.71 20	1.06 30	1.94 55	N/A	N/A	N/A	0.04 1	0.11 3	0.18 5	0.32 9	0.12 (3,05)	.0560 (14,22)	0.285 (7,24)
WP0	.53 15	.88 25	1.76 50	2.65 75	5.29 150	7.94 225	14.11 400	.21 6	.35 10	.35 10	.53 15	1.23 35	1.97 56	3.88 110	.010 (0,25)	.047 (1,19)	.030 (0,51)

NOTE: For basic switch operating forces, see page J-6.

HIGH FORCE, LOW MOTION PIVOT POSITION

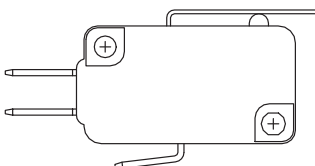

Available with actuators A10, A15, T10, T13, T14, T15, T16 and T18.

LOW FORCE, HIGH MOTION PIVOT POSITION

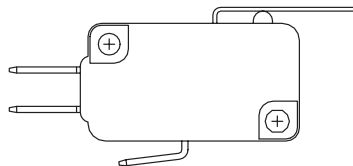

Available with actuators A20, A25, T20, T23, T24, T25, T26, and T28.

NOTE: Lever actuator options are available in either of two pivot positions. Levers located in the forward pivot position have lower forces and higher motions. Levers located in the rear pivot position have higher forces and lower motions.



Third Angle Projection

Dimensions are shown: Inches (mm)
Specifications and dimensions subject to change



Snap-acting

TF Series Miniature Snap-acting Switches

TERMINATIONS

40 .187" QUICK CONNECT

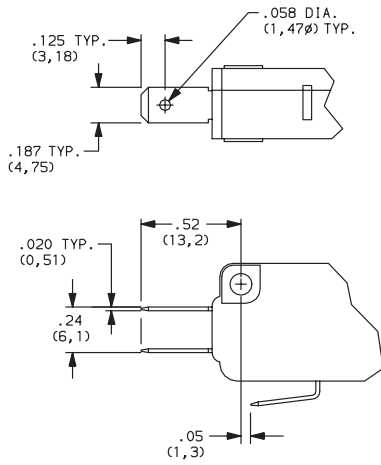

4A .250" QUICK CONNECT

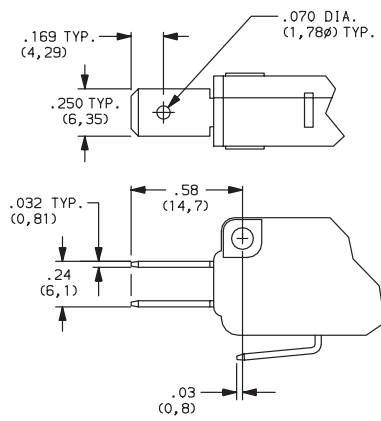

5A OFFSET .250" QUICK CONNECT

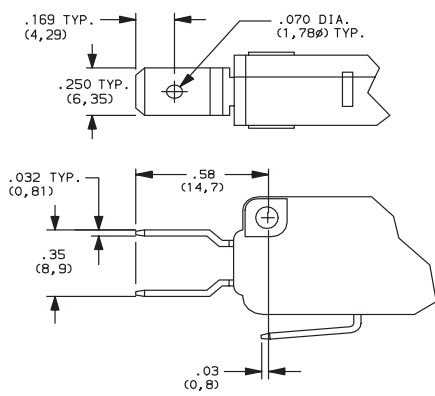

5B OFFSET .187" QUICK CONNECT

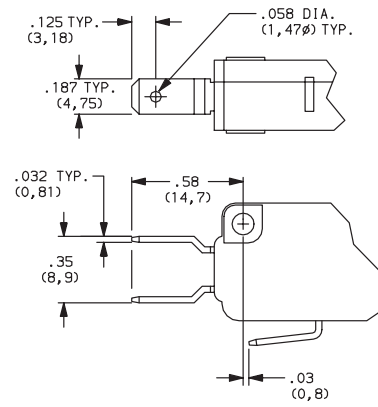

CIRCUITRY

- C** SPDT (Single Pole, Double Throw)
- W** SPST N.C. (Single Pole, Single Throw, Normally Closed)
- Y** SPST N.O. (Single Pole, Single Throw, Normally Open)

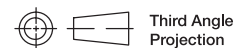

Third Angle
Projection

Dimensions are shown: Inch (mm)
Specifications and dimensions subject to change

