

Circuit Breaker for Equipment thermal, 2 pole, Rocker actuation



Description

- Thermal circuit breaker
- 1 or 2 pole thermal overload protection
- Positively trip-free release
- High configurability
- Rocker non-illuminated or illuminated
- Snap-in version
- Quick connect terminal 6.3 x 0.8 mm or screw clamp terminal M3.5 x 6 mm (lineside P1, P2)

Approvals

- Approval Reference Type: TA45
- IEC Standard: IEC 60934
- UL Standard: UL 1077
- CSA Standard: CSA C22.2 No. 235
- GB Standard: GB 17701

Applications

- Power tools
- Industrial appliances
- Power supplies

Weblinks

[pdf-datasheet](#), [html-datasheet](#), [General Product Information](#), [Approvals](#), [CE declaration of conformity](#), [RoHS](#), [CHINA-RoHS](#), [REACH](#), [Distributor-Stock-Check](#), [Detailed request for product](#), [Product News](#)

Technical Data

| | |
|------------------------------------|---|
| Rated Voltage AC | 240 V |
| Rated Voltage DC | 60 V |
| Rated current range AC | 0.05 - 20 A |
| Conditional short circuit capacity | IEC: Inc, PC1, AC 240 V: 1 kA |
| Degree of Protection | from front side IP 40 acc. to IEC 60529 |
| Dielectric Strength | 4 kVAC |
| Insulation resistance | 500VDC > 100 MΩ |
| Endurance typical | mechanical: 50'000 switching cycles |
| | AC: 1 x Ir: 50'000 switching cycles |
| | DC: 1 x Ir: 50'000 switching cycles |

| | |
|----------------------|---|
| Overload | AC: min. 40trips @ 6 x Ir |
| | DC: min. 40trips @ 4 x Ir |
| Ambient temperature | -10°C to 55°C |
| Vibration Resistance | ± 0.75 mm @ 5 - 60 Hz acc. to IEC 60068-2-6, test Fc 10 G @ 60 - 500 Hz acc. to IEC 60068-2-6, test Fc |
| Shock Resistance | 30 G / 18ms acc. to IEC 60068-2-27, test Ea |
| Tripping Type | Thermal |
| Actuation type | Rocker |
| Weight | 30 - 35g |

Dimension

Quick connect terminal

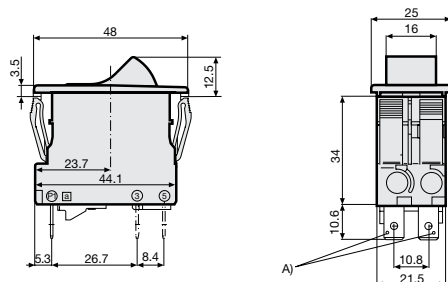

A) Quick connect terminal, IEC 61210, A6.3-0.8 mm

Screw clamp terminal

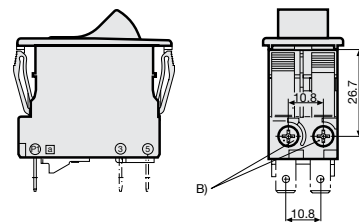

B) Screw type M3, 5x6 (Philips Form H), maximum torque 1 Nm

Accessories / factory mounted

AZM01 / Collar with cover, IP54

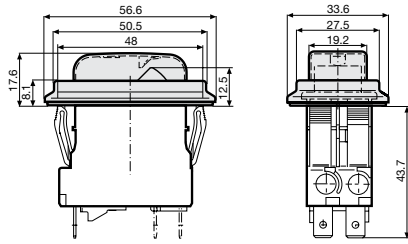

AZM02 / Raised collar with cover, narrow, IP54

AZM03 / Raised collar, IP40

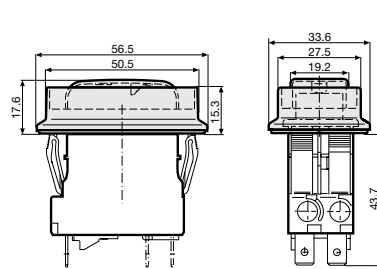

AZM10 / Collar with cover, narrow, IP54

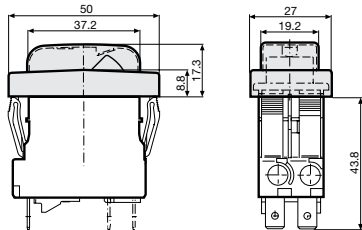

AZM11 / Partially raised collar with cover, narrow, IP54

AZM12 / Partially raised collar without cover, narrow, IP40

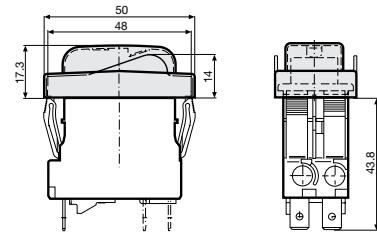

AZM13 / Raised collar narrow, IP40

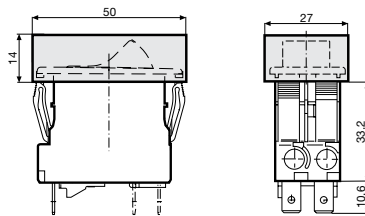

AZM14 / Raised collar with cover narrow, IP54

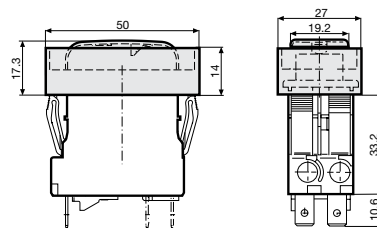

Cut-out and pin-out

Cut-out snap-in type

Pin-out

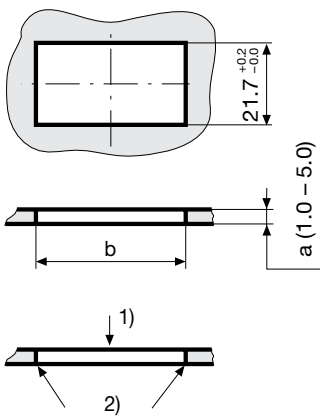

| a | b |
|-----|-------------|
| 1.0 | 44,5...45,0 |
| 1.5 | 44,5...45,0 |
| 2.0 | 44,7...45,2 |
| 2.5 | 44,7...45,2 |
| 3.0 | 44,8...45,3 |
| 4.0 | 44,9...45,4 |
| 5.0 | 45,0...45,5 |

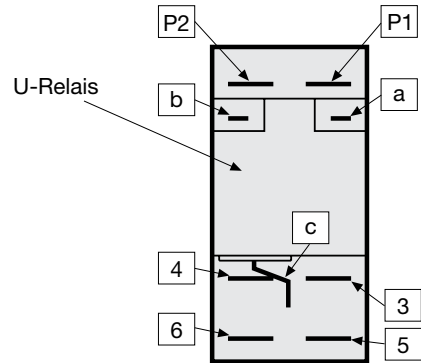

- 1) Assemble
- 2) edge must be sharp

Diagrams

Without thermal overload protection

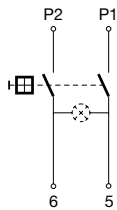

1 pole thermal overload protection

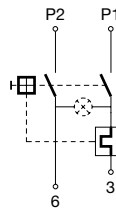

1 pole thermal overload protection, Shunt terminal

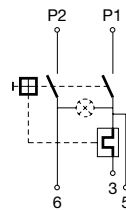

2 pole thermal overload protection

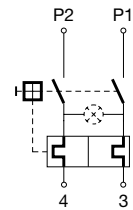

2 pole thermal overload protection, Shunt terminal

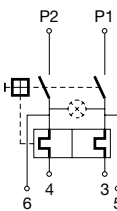

Time-Current-Curves

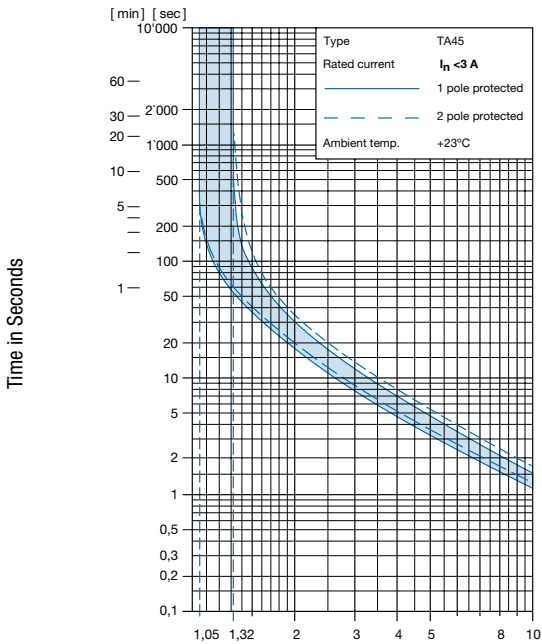

Multiple of Rated Current I_n

Reference Temperature +23°

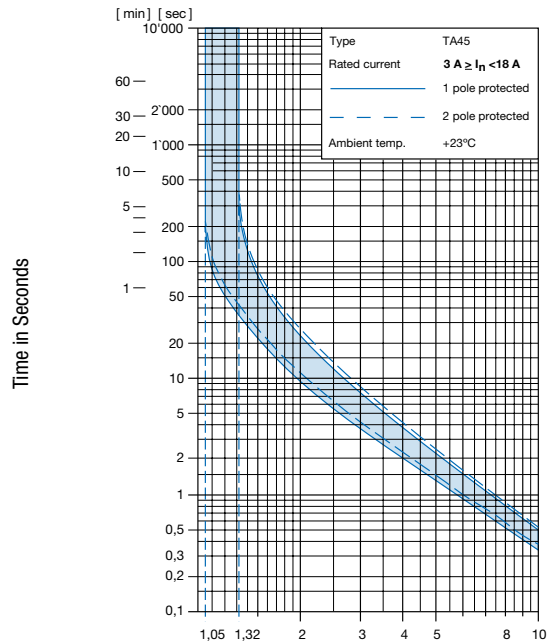

Multiple of Rated Current I_n

Reference Temperature +23°

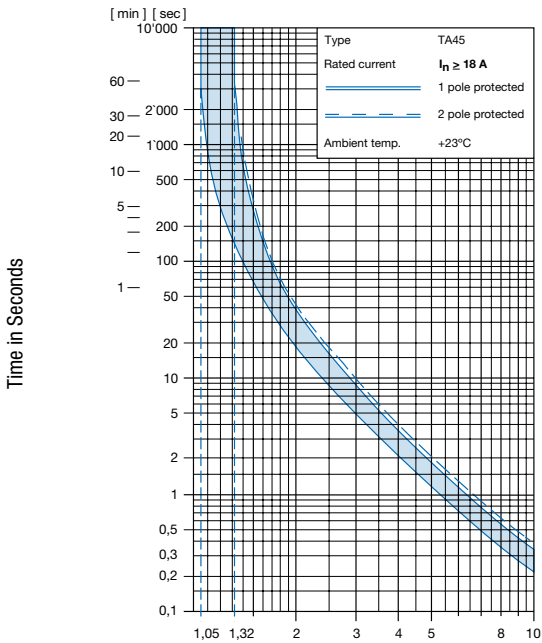

Multiple of Rated Current I_n

Reference Temperature +23°

Effect of ambient temperature

The units are calibrated for an ambient temperature of +23°C. To determine the rated current for a lower or higher ambient temperature, use a correction factor (typical value) from the table below:

| Ambient temperature [°C] | Correction factor |
|--------------------------|-------------------|
| -10 | 0.89 |
| -5 | 0.91 |
| 0 | 0.92 |
| +23 | 1.00 |
| +30 | 1.03 |
| +40 | 1.08 |
| +55 | 1.16 |

Example: Rated current = 5 A; Environmental temperature = 40 °C; --> Correction factor = 1.08; Resulting current = 5.5 A --> Fount to next higher rated current: 6 A

Config. Code

TA45 - AK2 W F 120 A2 - AZM11

The characters are placeholders for the correspondingly keys of selections from the key tables.

TA45 - AK2 W F 120 A2 - AZM11 = Basic function

| Basic function | Configuration key | Basic function | Configuration key |
|---|-------------------|--|-------------------|
| 2-pole, rocker, flat connection, illuminated 220 V...240 V | A02 | 2-pole, rocker, 2pole overload protection, shunt terminal, flat connection, illuminated 10 V...13 V | A48 |
| 2-pole, rocker, flat connection, illuminated 110 V...120 V | A04 | 2-pole, rocker, 2pole overload protection, shunt terminal, flat connection, illuminated 4 V...7 V | A49 |
| 2-pole, rocker, flat connection, illuminated 220 V...26 V | A07 | 2-pole, rocker, screw connection, illuminated 220 V...240 V | A52 |
| 2-pole, rocker, flat connection, illuminated 10 V...13 V | A08 | 2-pole, rocker, screw connection, illuminated 110 V...120 V | A54 |
| 2-pole, rocker, flat connection, illuminated 4 V...7 V | A09 | 2-pole, rocker, screw connection, illuminated 20 V...26 V | A57 |
| 2-pole, rocker, 1pole overload protection, flat connection, illuminated 220 V...240 V | A12 | 2-pole, rocker, screw connection, illuminated 10 V...13 V | A58 |
| 2-pole, rocker, 1pole overload protection, flat connection, illuminated 110 V...120 V | A14 | 2-pole, rocker, screw connection, illuminated 4 V...7 V | A59 |
| 2-pole, rocker, 1pole overload protection, flat connection, illuminated 20 V...26 V | A17 | 2-pole, rocker, 1pole overload protection, screw connection, illuminated 220 V...240 V | A62 |
| 2-pole, rocker, 1pole overload protection, flat connection, illuminated 10 V...13 V | A18 | 2-pole, rocker, 1pole overload protection, screw connection, illuminated 110 V...120 V | A64 |
| 2-pole, rocker, 1pole overload protection, flat connection, illuminated 4 V...7 V | A19 | 2-pole, rocker, 1pole overload protection, screw connection, illuminated 20 V...26 V | A67 |
| 2-pole, rocker, 1pole overload protection, shunt terminal, flat connection, illuminated 220 V...240 V | A22 | 2-pole, rocker, 1pole overload protection, screw connection, illuminated 10 V...13 V | A68 |
| 2-pole, rocker, 1pole overload protection, shunt terminal, flat connection, illuminated 110 V...120 V | A24 | 2-pole, rocker, 1pole overload protection, screw connection, illuminated 4 V...7 V | A69 |
| 2-pole, rocker, 1pole overload protection, shunt terminal, flat connection, illuminated 20 V...26 V | A27 | 2-pole, rocker, 1pole overload protection, shunt terminal, screw connection, illuminated 220 V...240 V | A72 |
| 2-pole, rocker, 1pole overload protection, shunt terminal, flat connection, illuminated 10 V...13 V | A28 | 2-pole, rocker, 1pole overload protection, shunt terminal, screw connection, illuminated 110 V...120 V | A74 |
| 2-pole, rocker, 1pole overload protection, shunt terminal, flat connection, illuminated 4 V...7 V | A29 | 2-pole, rocker, 1pole overload protection, shunt terminal, screw connection, illuminated 20 V...26 V | A77 |
| 2-pole, rocker, 2pole overload protection, flat connection, illuminated 220 V...240 V | A32 | 2-pole, rocker, 1pole overload protection, shunt terminal, screw connection, illuminated 10 V...13 V | A78 |
| 2-pole, rocker, 2pole overload protection, flat connection, illuminated 110 V...120 V | A34 | 2-pole, rocker, 1pole overload protection, shunt terminal, screw connection, illuminated 4 V...7 V | A79 |
| 2-pole, rocker, 2pole overload protection, flat connection, illuminated 20 V...26 V | A37 | 2-pole, rocker, 2pole overload protection, screw connection, illuminated 220 V...240 V | A82 |
| 2-pole, rocker, 2pole overload protection, flat connection, illuminated 10 V...13 V | A38 | 2-pole, rocker, 2pole overload protection, screw connection, illuminated 110 V...120 V | A84 |
| 2-pole, rocker, 2pole overload protection, flat connection, illuminated 4 V...7 V | A39 | 2-pole, rocker, 2pole overload protection, screw connection, illuminated 20 V...26 V | A87 |
| 2-pole, rocker, 2pole overload protection, shunt terminal, flat connection, illuminated 220 V...240 V | A42 | 2-pole, rocker, 2pole overload protection, screw connection, illuminated 10 V...13 V | A88 |
| 2-pole, rocker, 2pole overload protection, shunt terminal, flat connection, illuminated 110 V...120 V | A44 | 2-pole, rocker, 2pole overload protection, screw connection, illuminated 4 V...7 V | A89 |
| 2-pole, rocker, 2pole overload protection, shunt terminal, flat connection, illuminated 20 V...26 V | A47 | 2-pole, rocker, 2pole overload protection, shunt terminal, screw connection, illuminated 220 V...240 V | A92 |
| | | 2-pole, rocker, 2pole overload protection, shunt terminal, screw connection, illuminated 110 V...120 V | A94 |

| Basic function | Configuration key |
|---|-------------------|
| 2-pole, rocker, 2pole overload protection, shunt terminal, screw connection, illuminated 20 V...26 V | A97 |
| 2-pole, rocker, 2pole overload protection, shunt terminal, screw connection, illuminated 10 V...13 V | A98 |
| 2-pole, rocker, 2pole overload protection, shunt terminal, screw connection, illuminated 4 V...7 V | A99 |
| 2-pole, rocker, flat connection, without illumination | ABC |
| 2-pole, rocker, 2pole overload protection, flat connection, without illumination | ABD |
| 2-pole, rocker, 1pole overload protection, shunt terminal, flat connection, without illumination | ABF |
| 2-pole, rocker, 2pole overload protection, shunt terminal, flat connection, without illumination | ABG |
| 2-pole, rocker, 1pole overload protection, flat connection, without illumination | ABT |
| 2-pole, rocker, flat connection, momentary switch, without illumination | AEC |
| 2-pole, rocker, 2pole overload protection, flat connection, momentary switch, without illumination | AED |
| 2-pole, rocker, 1pole overload protection, shunt terminal, flat connection, momentary switch, without illumination | AEF |
| 2-pole, rocker, 2pole overload protection, shunt terminal, flat connection, momentary switch, without illumination | AEG |
| 2-pole, rocker, 1pole overload protection, flat connection, momentary switch, without illumination | AET |
| 2-pole, rocker, screw connection, without illumination | AHC |
| 2-pole, rocker, 2pole overload protection, screw connection, without illumination | AHD |
| 2-pole, rocker, 1pole overload protection, shunt terminal, screw connection, without illumination | AHF |
| 2-pole, rocker, 2pole overload protection, shunt terminal, screw connection, without illumination | AHG |
| 2-pole, rocker, 1pole overload protection, screw connection, without illumination | AHT |
| 2-pole, rocker, screw connection, momentary switch, without illumination | AJC |
| 2-pole, rocker, 2pole overload protection, screw connection, momentary switch, without illumination | AJD |
| 2-pole, rocker, 1pole overload protection, shunt terminal, screw connection, momentary switch, without illumination | AJF |
| 2-pole, rocker, 2pole overload protection, shunt terminal, screw connection, momentary switch, without illumination | AJG |
| 2-pole, rocker, 1pole overload protection, screw connection, momentary switch, without illumination | AJT |

TA45 - AK2 W F 120 A2 - AZM11 = Actuator colour

| Actuator colour | Configuration key |
|--------------------|-------------------|
| Clear transparent | 1 |
| Red transparent | 3 |
| Green transparent | 4 |
| Orange transparent | 6 |
| Black | B |
| Green | G |
| Red | R |
| White | W |
| Orange | X |
| Yellow | Y |

TA45 - AK2 W F 120 A2 - AZM11 = Legend

| Legend | Configuration key |
|---------------|-------------------|
| embossed | F |
| white printed | H |
| black printed | K |
| white printed | L |
| black printed | M |
| white printed | P |
| black printed | R |
| white printed | S |
| black printed | T |

TA45 - AK2 W F 120 A2 - AZM11 = Rated current

| Rated current | Configuration key |
|--|-------------------|
| without thermal overload protection / temporarily without VDE approval | C00 |
| 0.05 A | Z05 |
| 0.1 A | J01 |
| 0.2 A | J02 |
| 0.3 A | J03 |
| 0.4 A | J04 |
| 0.5 A | J05 |
| 0.6 A | J06 |
| 0.7 A | J07 |
| 0.8 A | J08 |
| 0.9 A | J09 |
| 1.0 A | J10 |
| 1.1 A | J11 |
| 1.2 A | J12 |
| 1.3 A | J13 |
| 1.4 A | J14 |
| 1.5 A | J15 |
| 1.6 A | J16 |
| 1.7 A | J17 |
| 1.8 A | J18 |
| 1.9 A | J19 |
| 2.0 A | J20 |
| 2.1 A | J21 |
| 2.2 A | J22 |
| 2.3 A | J23 |
| 2.5 A | J25 |
| 2.8 A | J28 |

Other rated currents on request

| Rated current | Configuration key |
|---------------|-------------------|
| 3.0 A | 030 |
| 3.5 A | 035 |
| 4.0 A | 040 |
| 4.5 A | 045 |
| 5.0 A | 050 |
| 6.0 A | 060 |
| 6.5 A | 065 |
| 7.0 A | 070 |
| 7.5 A | 075 |
| 8.0 A | 080 |
| 9.0 A | 090 |
| 10.0 A | 100 |
| 11.0 A | 110 |
| 12.0 A | 120 |
| 13.0 A | 130 |
| 14.0 A | 140 |
| 15.0 A | 150 |
| 16.0 A | 160 |
| 17.0 A | 170 |
| 18.0 A | 180 |
| 19.0 A | 190 |
| 20.0 A | 200 |

Other rated currents on request

TA45 - AK2 W F 120 **A2** - AZM11 = Release / lock-out latch

| Release / lock-out latch | Configuration key |
|----------------------------------|-------------------|
| without release / lock-out latch | C0 |

TA45 - AK2 W F 120 A2 - **AZM11** = Accessories

| Factory mounted accessories | Configuration key |
|---|-------------------|
| Without cover | |
| Collar with cover, IP54 | AZM01 |
| Raised collar with cover, IP54 | AZM02 |
| Raised collar, IP40 | AZM03 |
| Raised collar with cover narrow, IP54 | AZM10 |
| Partially raised collar with cover, narrow, IP54 | AZM11 |
| Partially raised collar without cover, narrow, IP40 | AZM12 |
| Raised collar narrow, IP40 | AZM13 |
| Raised collar with cover narrow, IP54 | AZM14 |

For subsequent fitting accessories see:

http://www.schurter.ch/pdf/english/typ_TA45-ACC.pdf

Variants

| Thermal overload protection | Addition | connection type | Illumination | Actuator colour | Legend | Rated current | Accessories | Config. Code | Order Number |
|-----------------------------|----------|------------------------|----------------------|-----------------|---------------|---------------|---------------|-----------------|--------------|
| 1-pole | | Quick connect terminal | without illumination | White | embossed | 10.0 A | Without cover | TA45-ABTWF100C0 | 4430.0022 |
| 2-pole | | Quick connect terminal | without illumination | Black | white printed | 15.0 A | Without cover | TA45-ABDBL150C0 | 4430.1089 |
| 2-pole | | Quick connect terminal | without illumination | Black | white printed | 15.0 A | Without cover | TA45-ABDBS150C0 | 4430.1328 |

Most Popular.

Availability for all products can be searched real-time: <http://www.schurter.com/Stock-Check/Stock-Check-SCHURTER>

Packaging Unit 1 Pcs

Accessories

