



3.3 V FULL-DUPLEX RS-485/RS-422 DRIVERS AND BALANCED RECEIVERS

FEATURES

- Designed for INTERBUS Applications
- Balanced Receiver Thresholds
- 1/2 Unit-Load (up to 64 nodes on the bus)
- Bus-Pin ESD Protection 15 kV HBM
- Bus-Fault Protection of -7V to 12V
- Thermal Shutdown Protection
- Power-Up/Down Glitch-free Bus Inputs and Outputs
- High Input Impedance with Low V_{CC}
- Monotonic Outputs During Power Cycling
- 5V Tolerant Inputs

APPLICATIONS

- Digital Motor Control
- Utility Meters
- Chassis-to-Chassis Interconnections
- Electronic Security Stations
- Industrial, Process, and Building Automation
- Point-of-Sale (POS) Terminals and Networks
- DTE/DCE Interfaces

DESCRIPTION

The SN65HVD379 is a differential line driver and differential-input line receiver that operates with a 3.3-V power supply. Each driver and receiver has separate input and output pins for full-duplex bus communication designs. They are designed for balanced transmission lines and interoperability with ANSI TIA/EIA-485A, TIA/EIA-422-B, ITU-T v.11, and ISO 8482:1993 standard-compliant devices.

These differential bus drivers and receivers are monolithic, integrated circuits designed for full-duplex bi-directional data communication on multipoint bus-transmission lines at signaling rates⁽¹⁾ up to 25 Mbps. The SN65HVD379 is fully enabled with no external enabling pins.

The 1/2 unit load receiver has a higher receiver input resistance. This results in lower bus leakage currents over the common-mode voltage range, and reduces the total amount of current that an RS-485 driver is forced to source or sink when transmitting.

The balanced differential receiver input threshold makes the SN65HVD379 more compatible with fieldbus requirements that define an external failsafe structure.

(1) The signaling rate of a line is the number of voltage transitions that are made per second expressed in the units bps (bits per second).

BALANCED RECEIVER INPUT THRESHOLDS

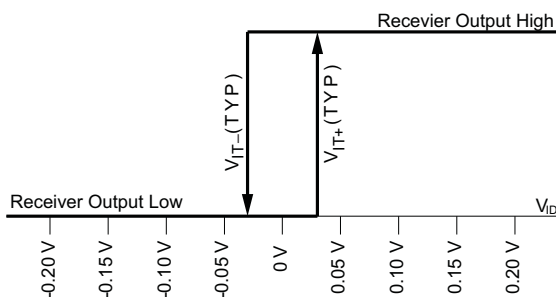

SN65HVD379

D PACKAGE (TOP VIEW)

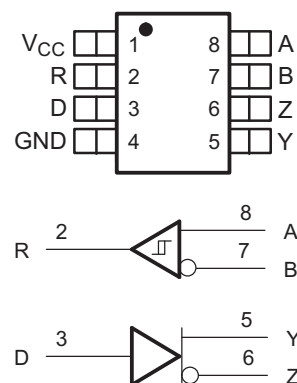

Please be aware that an important notice concerning availability, standard warranty, and use in critical applications of Texas Instruments semiconductor products and disclaimers thereto appears at the end of this data sheet.



This integrated circuit can be damaged by ESD. Texas Instruments recommends that all integrated circuits be handled with appropriate precautions. Failure to observe proper handling and installation procedures can cause damage.

ESD damage can range from subtle performance degradation to complete device failure. Precision integrated circuits may be more susceptible to damage because very small parametric changes could cause the device not to meet its published specifications.

ORDERING INFORMATION

SIGNALING RATE	UNIT LOADS	PART NUMBER ⁽¹⁾	SOIC MARKING
25 Mbps	1/2	SN65HVD379	

(1) These are The D package is available taped and reeled. Add an R suffix to the part number (ie. SN65HVD379DR).

ABSOLUTE MAXIMUM RATINGS

over operating free-air temperature range unless otherwise noted⁽¹⁾⁽²⁾

		UNIT
V_{CC}	Supply voltage range	-0.3 V to 6 V
V_A, V_B, V_Y, V_Z	Voltage range at any bus terminal (A, B, Y, Z)	-9 V to 14 V
V_{TRANS}	Voltage input, transient pulse through 100 Ω . See Figure 8 (A, B, Y, Z) ⁽³⁾	-50 to 50 V
V_I	Input voltage range (D, DE, \overline{RE})	-0.5 V to 7 V
P_{CONT}	Continuous total power dissipation	Internally limited ⁽⁴⁾
I_O	Output current (receiver output only, R)	11 mA

- Stresses beyond those listed under absolute maximum ratings may cause permanent damage to the device. These are stress ratings only, and functional operation of the device at these or any other conditions beyond those indicated under recommended operating conditions is not implied. Exposure to absolute-maximum-rated conditions for extended periods may affect device reliability.
- All voltage values, except differential I/O bus voltages, are with respect to network ground terminal.
- This tests survivability only and the output state of the receiver is not specified.
- The Thermal shutdown protection circuit internally limits the continuous total power dissipation. Thermal shutdown typically occurs when the junction temperature reaches 165°C.

RECOMMENDED OPERATING CONDITIONS

over operating free-air temperature range unless otherwise noted

PARAMETER		MIN	NOM	MAX	UNIT
V_{CC}	Supply voltage	3.0		3.6	V
V_I or V_{IC}	Voltage at any bus terminal (separately or common mode)	-7 ⁽¹⁾		12	
$1/t_{UI}$	Signaling rate			25	Mbps
R_L	Differential load resistance	54	60		Ω
V_{IH}	High-level input voltage	2		V_{CC}	
V_{IL}	Low-level input voltage	0		0.8	V
V_{ID}	Differential input voltage	-12		12	
I_{OH}	High-level output current	Driver		-60	mA
		Receiver		-8	
I_{OL}	Low-level output current	Driver		60	mA
		Receiver		8	
T_A	Ambient still-air temperature	-40		85	°C

(1) The algebraic convention, in which the least positive (most negative) limit is designated as minimum is used in this data sheet.

ELECTROSTATIC DISCHARGE PROTECTION

PARAMETER	TEST CONDITIONS	MIN	TYP ⁽¹⁾	MAX	UNIT
Human body model	Bus terminals and GND	±16			kV
Human body model ⁽²⁾	All pins	±4			
Charged-device-model ⁽³⁾	All pins	±1			

- (1) All typical values at 25°C with 3.3-V supply.
 (2) Tested in accordance with JEDEC Standard 22, Test Method A114-A.
 (3) Tested in accordance with JEDEC Standard 22, Test Method C101.

DRIVER ELECTRICAL CHARACTERISTICS

over recommended operating conditions unless otherwise noted

PARAMETER	TEST CONDITIONS	MIN	TYP ⁽¹⁾	MAX	UNIT
$V_{I(K)}$ Input clamp voltage	$I_I = -18$ mA	-1.5			V
$ V_{OD(SS)} $ Steady-state differential output voltage	$I_O = 0$	2.0		V_{CC}	
	$R_L = 54$ Ω , See Figure 1 ⁽²⁾ (RS-485)	1.5	2.0		
	$R_L = 100$ Ω , See Figure 1 (RS-422)	2.0	2.3		
	$V_{test} = -7$ V to 12 V, See Figure 2	1.5			
$\Delta V_{OD(SS)} $ Change in magnitude of steady-state differential output voltage between states	$R_L = 54$ Ω , See Figure 1 and Figure 2	-0.2		0.2	V
$V_{OD(RING)}$ Differential Output Voltage overshoot and undershoot	$R_L = 54$ Ω , $C_L = 50$ pF, See Figure 5 (Figure 3 for definitions)			10% ⁽³⁾	
$V_{OC(PP)}$ Peak-to-peak common-mode output voltage	See Figure 3		0.5		
$V_{OC(SS)}$ Steady-state common-mode output voltage		1.6	2.3		
$\Delta V_{OC(SS)}$ Change in steady-state common-mode output voltage		-0.05	0.05		
$I_{Z(Z)}$ or $I_{Y(Z)}$ High-impedance state output current		$V_{CC} = 0$ V, V_Z or $V_Y = 12$ V, Other input at 0 V			90
	$V_{CC} = 0$ V, V_Z or $V_Y = -7$ V, Other input at 0 V	-10			
$I_{Z(S)}$ or $I_{Y(S)}$ Short Circuit output Current	V_Z or $V_Y = -7$ V	Other input at 0 V	-250	250	mA
	V_Z or $V_Y = 12$ V		-250	250	
I_I Input current	D	$V_I = 0$ or $V_I = 2.0$	0	100	μ A
$C_{(OD)}$ Differential output capacitance		$V_{OD} = 0.4 \sin(4E6\pi t) + 0.5$ V, V_{CC} at 0 V		16	pF

- (1) All typical values are at 25°C and with a 3.3-V supply.
 (2) V_{CC} is 3.3 Vdc \pm 5%
 (3) 10% of the peak-to-peak Differential Output voltage swing, per TIA/EIA-485.

DRIVER SWITCHING CHARACTERISTICS

over recommended operating conditions unless otherwise noted

PARAMETER	TEST CONDITIONS	MIN	TYP ⁽¹⁾	MAX	UNIT
t_{PLH} Propagation delay time, low-to-high-level output	$R_L = 54$ Ω , $C_L = 50$ pF, See Figure 5	4	10	18	ns
t_{PHL} Propagation delay time, high-to-low-level output					
t_r Differential output signal rise time		2.5	5	12	ns
t_f Differential output signal fall time					
$t_{sk(p)}$ Pulse skew ($ t_{PHL} - t_{PLH} $)				0.6	ns
$t_{sk(pp)}$ ⁽²⁾ Part-to-part skew				1	ns

- (1) All typical values are at 25°C and with a 3.3-V supply.
 (2) $t_{sk(pp)}$ is the magnitude of the difference in propagation delay times between any specified terminals of two devices when both devices operate with the same supply voltages, at the same temperature, and have identical packages and test circuits.

RECEIVER ELECTRICAL CHARACTERISTICS

over recommended operating conditions unless otherwise noted

PARAMETER		TEST CONDITIONS	MIN	TYP ⁽¹⁾	MAX	UNIT
V_{IT+}	Positive-going differential input threshold voltage	$I_O = -8$ mA			0.2	V
V_{IT-}	Negative-going differential input threshold voltage	$I_O = 8$ mA	-0.2			
V_{hys}	Hysteresis voltage ($V_{IT+} - V_{IT-}$)			50		mV
V_O	Output voltage	$V_{ID} = 200$ mV, $I_O = -8$ mA, See Figure 7	2.4			V
		$V_{ID} = -200$ mV, $I_O = 8$ mA, See Figure 7			0.4	
I_A or I_B	Bus input current	V_A or $V_B = 12$ V	Other input at 0 V	0.20	0.35	mA
		V_A or $V_B = 12$ V, $V_{CC} = 0$ V		0.24	0.40	
		V_A or $V_B = -7$ V		-0.35	-0.18	
		V_A or $V_B = -7$ V, $V_{CC} = 0$ V		-0.25	-0.13	
C_{ID}	Differential input capacitance	$V_{ID} = 0.4 \sin(4E6\pi t) + 0.5$ V, DE at 0 V		15		pF
I_{CC}	Supply current	D at 0 V or V_{CC} and No Load			2.1	mA

(1) All typical values are at 25°C and with a 3.3-V supply.

RECEIVER SWITCHING CHARACTERISTICS

over recommended operating conditions unless otherwise noted

PARAMETER		TEST CONDITIONS	MIN	TYP ⁽¹⁾	MAX	UNIT
t_{PLH}	Propagation delay time, low-to-high-level output	$V_{ID} = -1.5$ V to 1.5 V, $C_L = 15$ pF, See Figure 7		26	45	ns
t_{PHL}	Propagation delay time, high-to-low-level output					
$t_{sk(p)}$	Pulse skew ($ t_{PHL} - t_{PLH} $)				7	
$t_{sk(pp)}$	Part-to-part skew ⁽²⁾			5		
t_r	Output signal rise time				5	
t_f	Output signal fall time				6	

(1) All typical values are at 25°C and with a 3.3-V supply

(2) $t_{sk(pp)}$ is the magnitude of the difference in propagation delay times between any specified terminals of two devices when both devices operate with the same supply voltages, at the same temperature, and have identical packages and test circuits.

DEVICE POWER DISSIPATION – P_D

PARAMETER	TEST CONDITIONS	MIN	TYP	MAX	UNIT
P_D	$R_L = 60$, $C_L = 50$ pF, Input to D a 50% duty cycle square wave at indicated signaling rate $T_A = 85^\circ\text{C}$			197	mW

FUNCTION TABLES

DRIVER			RECEIVER	
INPUT	OUTPUTS		DIFFERENTIAL INPUTS	OUTPUTS
D	Y	Z	$V_{ID} = V_A - V_B$	R
H	H	L	$V_{ID} \leq -0.2$ V	L
L	L	H	-0.2 V $< V_{ID} < 0.2$ V	?
Open	L	H	0.2 V $\leq V_{ID}$	H

PARAMETER MEASUREMENT INFORMATION

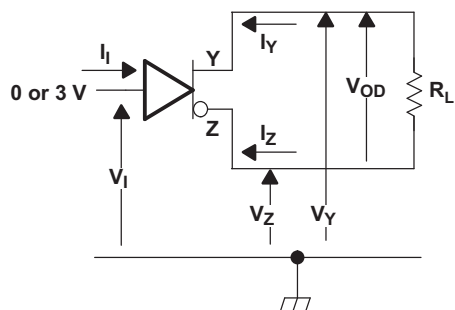

Figure 1. Driver V_{OD} Test Circuit and Voltage and Current Definitions

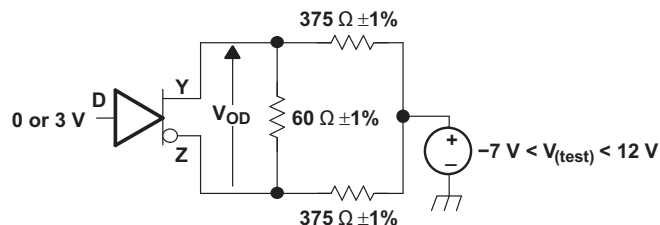

Figure 2. Driver V_{OD} With Common-Mode Loading Test Circuit

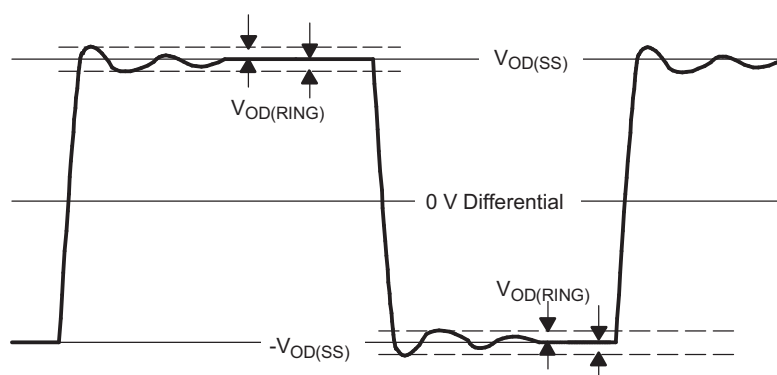
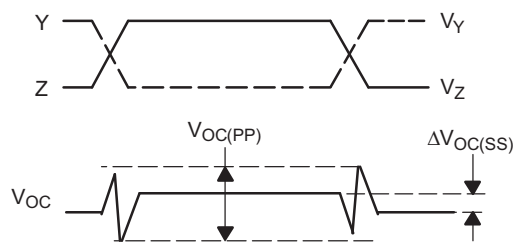
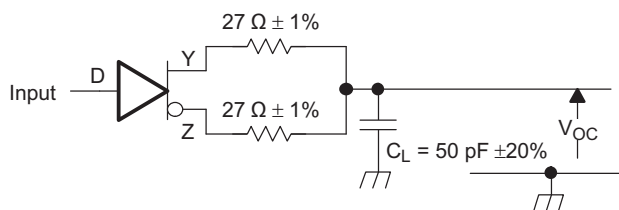

Figure 3. $V_{OD(RING)}$ Waveform and Definitions

$V_{OD(RING)}$ is measured at four points on the output waveform, corresponding to overshoot and undershoot from the $V_{OD(H)}$ and $V_{OD(L)}$ steady state values.



C_L Includes Fixture and Instrumentation Capacitance

Input: PRR = 500 kHz, 50% Duty Cycle, $t_r < 6ns$, $t_f < 6ns$, $Z_O = 50 \Omega$

Figure 4. Test Circuit and Definitions for the Driver Common-Mode Output Voltage

PARAMETER MEASUREMENT INFORMATION (continued)

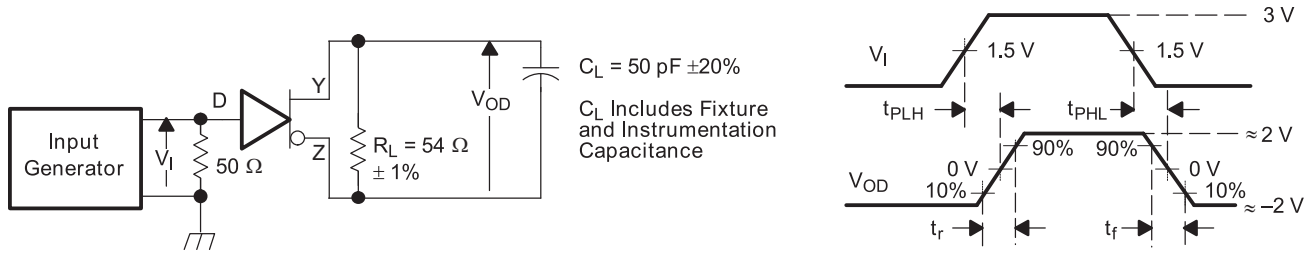

Figure 5. Driver Switching Test Circuit and Voltage Waveforms

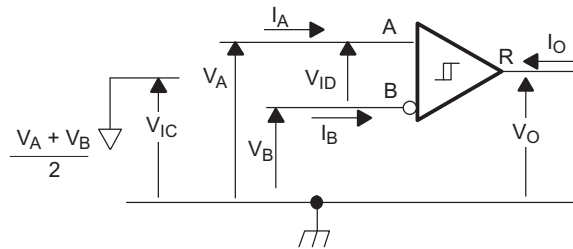

Figure 6. Receiver Voltage and Current Definitions

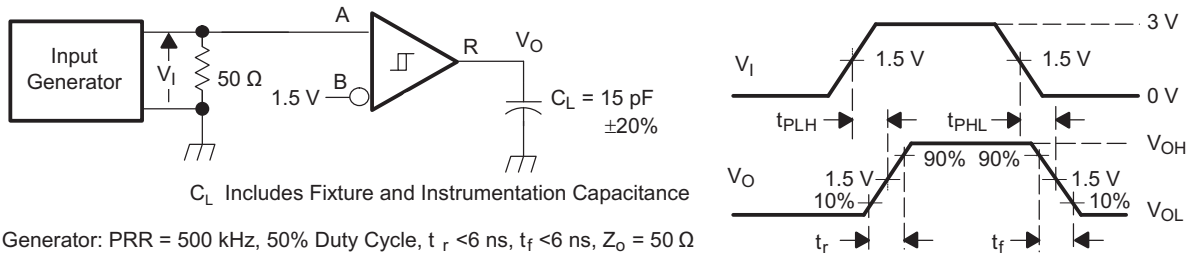

Figure 7. Receiver Switching Test Circuit and Voltage Waveforms

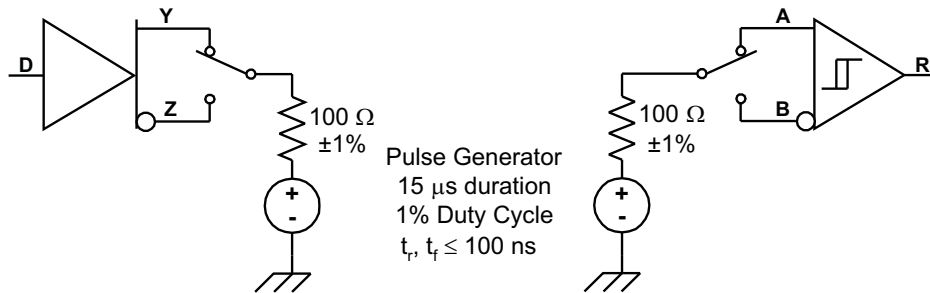
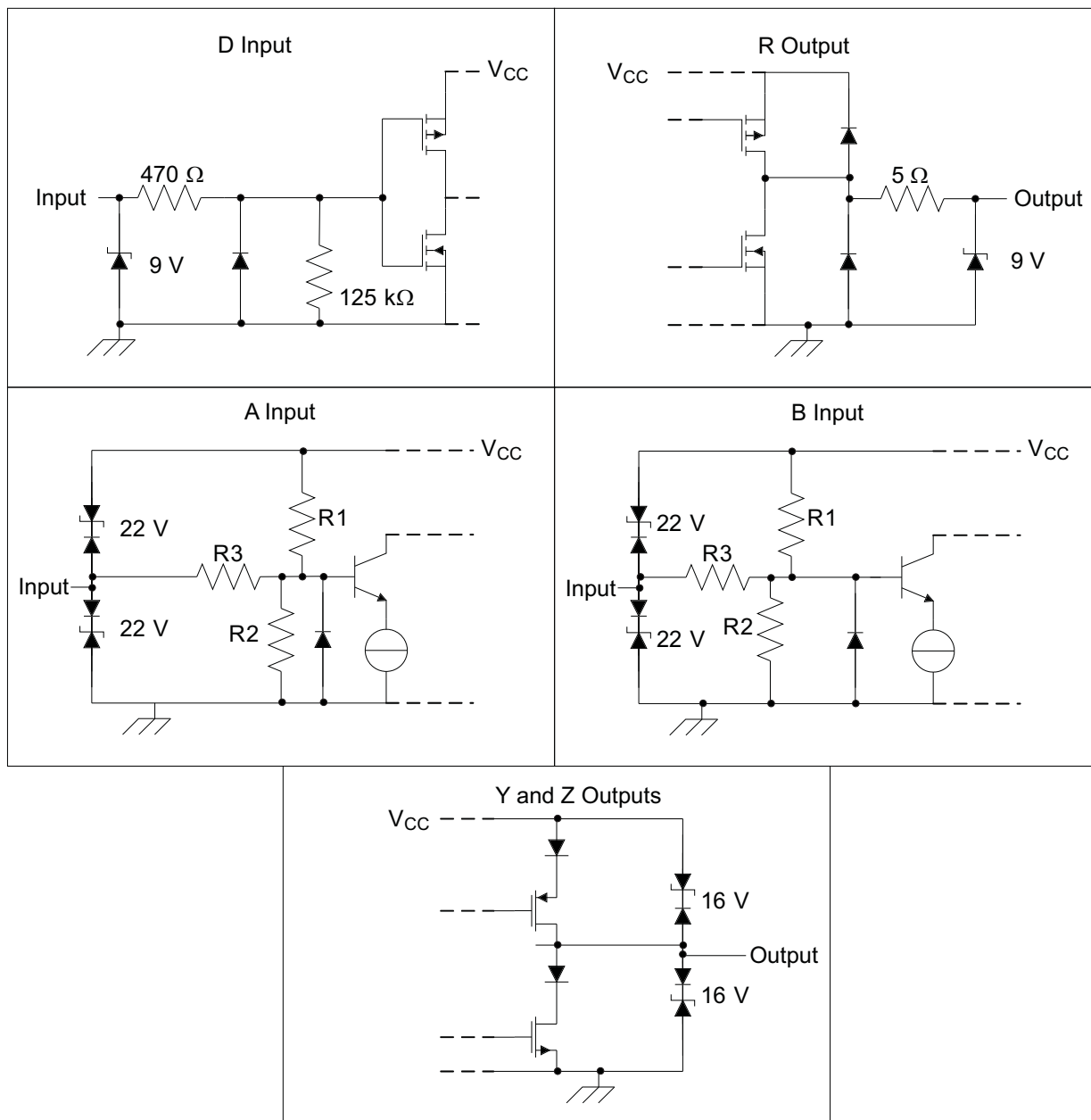

Figure 8. Test Circuit, Transient Over Voltage Test

EQUIVALENT INPUT AND OUTPUT SCHEMATIC DIAGRAMS



	R1/R2	R3
SN65HVD379	9 kΩ	45 kΩ

TYPICAL CHARACTERISTICS

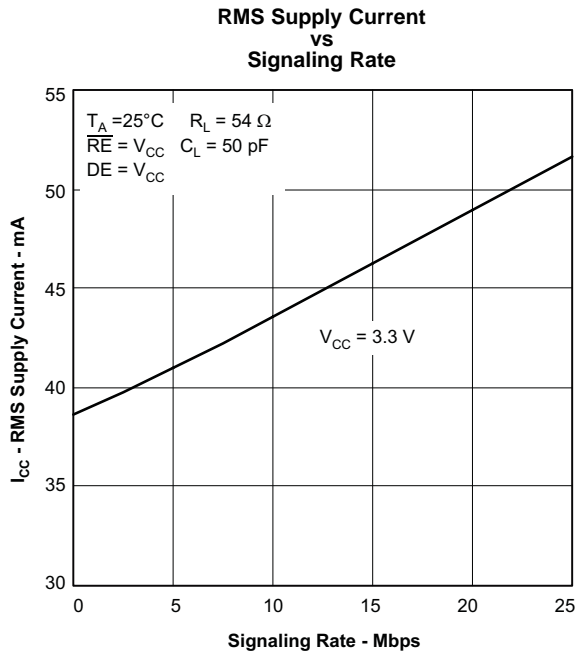

Figure 9.

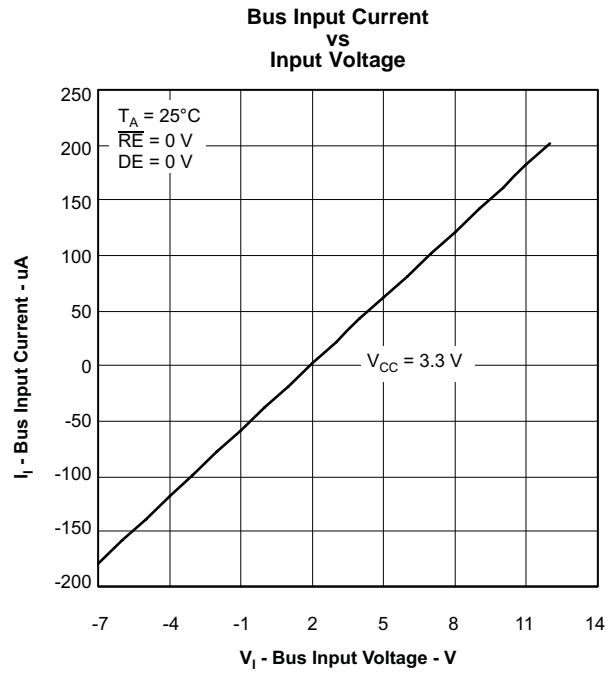

Figure 10.

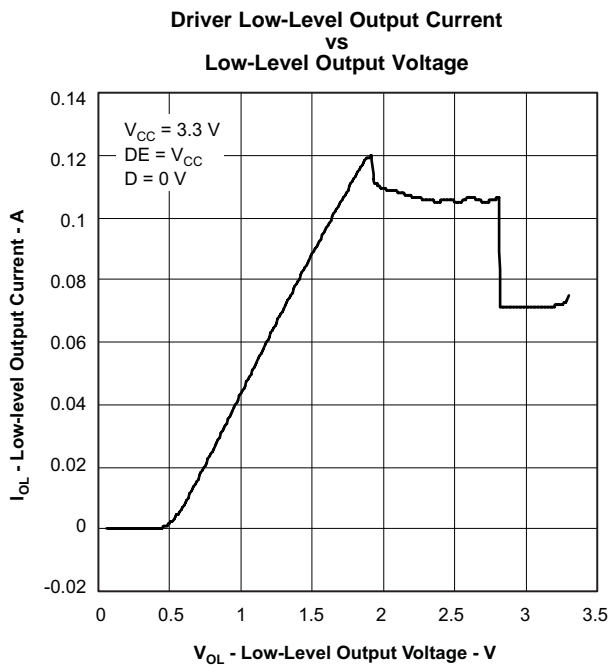

Figure 11.

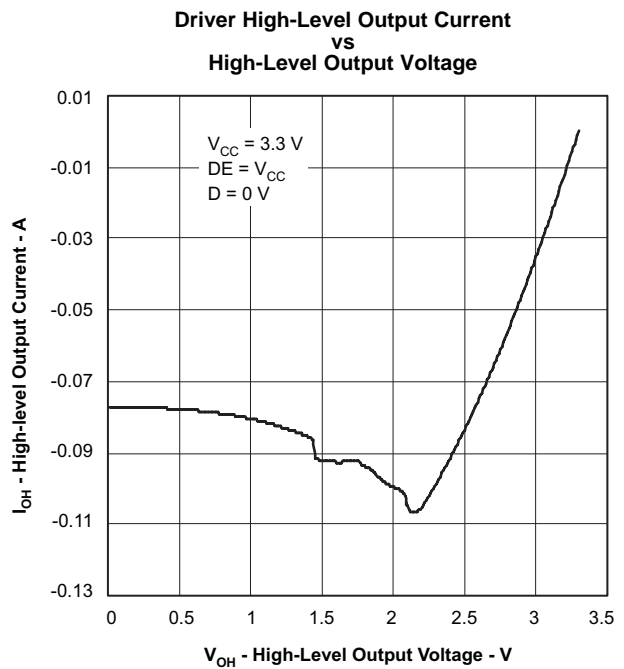

Figure 12.

TYPICAL CHARACTERISTICS (continued)

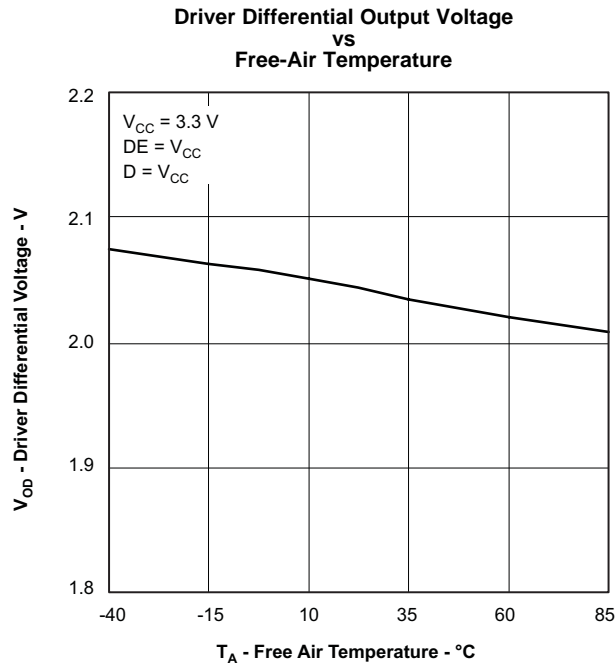

Figure 13.

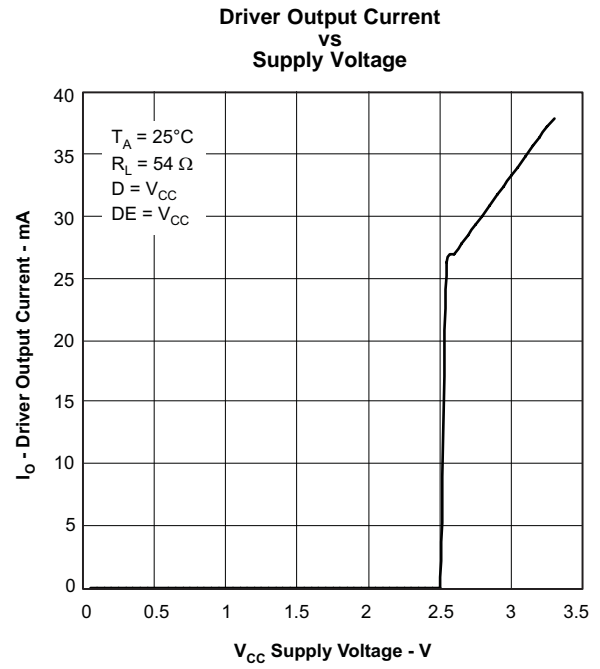

Figure 14.

PACKAGING INFORMATION

Orderable Device	Status ⁽¹⁾	Package Type	Package Drawing	Pins	Package Qty	Eco Plan ⁽²⁾	Lead/Ball Finish	MSL Peak Temp ⁽³⁾
SN65HVD379D	ACTIVE	SOIC	D	8	75	Green (RoHS & no Sb/Br)	CU NIPDAU	Level-1-260C-UNLIM
SN65HVD379DG4	ACTIVE	SOIC	D	8	75	Green (RoHS & no Sb/Br)	CU NIPDAU	Level-1-260C-UNLIM
SN65HVD379DR	ACTIVE	SOIC	D	8	2500	Green (RoHS & no Sb/Br)	CU NIPDAU	Level-1-260C-UNLIM
SN65HVD379DRG4	ACTIVE	SOIC	D	8	2500	Green (RoHS & no Sb/Br)	CU NIPDAU	Level-1-260C-UNLIM

⁽¹⁾ The marketing status values are defined as follows:

ACTIVE: Product device recommended for new designs.

LIFEBUY: TI has announced that the device will be discontinued, and a lifetime-buy period is in effect.

NRND: Not recommended for new designs. Device is in production to support existing customers, but TI does not recommend using this part in a new design.

PREVIEW: Device has been announced but is not in production. Samples may or may not be available.

OBSOLETE: TI has discontinued the production of the device.

⁽²⁾ Eco Plan - The planned eco-friendly classification: Pb-Free (RoHS), Pb-Free (RoHS Exempt), or Green (RoHS & no Sb/Br) - please check <http://www.ti.com/productcontent> for the latest availability information and additional product content details.

TBD: The Pb-Free/Green conversion plan has not been defined.

Pb-Free (RoHS): TI's terms "Lead-Free" or "Pb-Free" mean semiconductor products that are compatible with the current RoHS requirements for all 6 substances, including the requirement that lead not exceed 0.1% by weight in homogeneous materials. Where designed to be soldered at high temperatures, TI Pb-Free products are suitable for use in specified lead-free processes.

Pb-Free (RoHS Exempt): This component has a RoHS exemption for either 1) lead-based flip-chip solder bumps used between the die and package, or 2) lead-based die adhesive used between the die and leadframe. The component is otherwise considered Pb-Free (RoHS compatible) as defined above.

Green (RoHS & no Sb/Br): TI defines "Green" to mean Pb-Free (RoHS compatible), and free of Bromine (Br) and Antimony (Sb) based flame retardants (Br or Sb do not exceed 0.1% by weight in homogeneous material)

⁽³⁾ MSL, Peak Temp. -- The Moisture Sensitivity Level rating according to the JEDEC industry standard classifications, and peak solder temperature.

Important Information and Disclaimer:The information provided on this page represents TI's knowledge and belief as of the date that it is provided. TI bases its knowledge and belief on information provided by third parties, and makes no representation or warranty as to the accuracy of such information. Efforts are underway to better integrate information from third parties. TI has taken and continues to take reasonable steps to provide representative and accurate information but may not have conducted destructive testing or chemical analysis on incoming materials and chemicals. TI and TI suppliers consider certain information to be proprietary, and thus CAS numbers and other limited information may not be available for release.

In no event shall TI's liability arising out of such information exceed the total purchase price of the TI part(s) at issue in this document sold by TI to Customer on an annual basis.

D (R-PDSO-G8)

PLASTIC SMALL-OUTLINE PACKAGE



- NOTES:
- A. All linear dimensions are in inches (millimeters).
 - B. This drawing is subject to change without notice.
 - C. Body length does not include mold flash, protrusions, or gate burrs. Mold flash, protrusions, or gate burrs shall not exceed .006 (0,15) per end.
 - D. Body width does not include interlead flash. Interlead flash shall not exceed .017 (0,43) per side.
 - E. Reference JEDEC MS-012 variation AA.

IMPORTANT NOTICE

Texas Instruments Incorporated and its subsidiaries (TI) reserve the right to make corrections, modifications, enhancements, improvements, and other changes to its products and services at any time and to discontinue any product or service without notice. Customers should obtain the latest relevant information before placing orders and should verify that such information is current and complete. All products are sold subject to TI's terms and conditions of sale supplied at the time of order acknowledgment.

TI warrants performance of its hardware products to the specifications applicable at the time of sale in accordance with TI's standard warranty. Testing and other quality control techniques are used to the extent TI deems necessary to support this warranty. Except where mandated by government requirements, testing of all parameters of each product is not necessarily performed.

TI assumes no liability for applications assistance or customer product design. Customers are responsible for their products and applications using TI components. To minimize the risks associated with customer products and applications, customers should provide adequate design and operating safeguards.

TI does not warrant or represent that any license, either express or implied, is granted under any TI patent right, copyright, mask work right, or other TI intellectual property right relating to any combination, machine, or process in which TI products or services are used. Information published by TI regarding third-party products or services does not constitute a license from TI to use such products or services or a warranty or endorsement thereof. Use of such information may require a license from a third party under the patents or other intellectual property of the third party, or a license from TI under the patents or other intellectual property of TI.

Reproduction of information in TI data books or data sheets is permissible only if reproduction is without alteration and is accompanied by all associated warranties, conditions, limitations, and notices. Reproduction of this information with alteration is an unfair and deceptive business practice. TI is not responsible or liable for such altered documentation.

Resale of TI products or services with statements different from or beyond the parameters stated by TI for that product or service voids all express and any implied warranties for the associated TI product or service and is an unfair and deceptive business practice. TI is not responsible or liable for any such statements.

Following are URLs where you can obtain information on other Texas Instruments products and application solutions:

Products		Applications	
Amplifiers	amplifier.ti.com	Audio	www.ti.com/audio
Data Converters	dataconverter.ti.com	Automotive	www.ti.com/automotive
DSP	dsp.ti.com	Broadband	www.ti.com/broadband
Interface	interface.ti.com	Digital Control	www.ti.com/digitalcontrol
Logic	logic.ti.com	Military	www.ti.com/military
Power Mgmt	power.ti.com	Optical Networking	www.ti.com/opticalnetwork
Microcontrollers	microcontroller.ti.com	Security	www.ti.com/security
Low Power Wireless	www.ti.com/lpw	Telephony	www.ti.com/telephony
		Video & Imaging	www.ti.com/video
		Wireless	www.ti.com/wireless

Mailing Address: Texas Instruments
Post Office Box 655303 Dallas, Texas 75265