

## N-Channel 150-V (D-S) MOSFET

### PRODUCT SUMMARY

$V_{DS}$ (V)	$r_{DS(on)}$ ( $\Omega$ )	$I_D$ (A)
150	0.050 at $V_{GS} = 10$ V	6.7

### FEATURES

- TrenchFET<sup>®</sup> Power MOSFETS
- New Low Thermal Resistance PowerPAK<sup>®</sup> Package with Low 1.07-mm Profile
- PWM Optimized for Fast Switching
- 100 %  $R_g$  Tested



**RoHS\***  
COMPLIANT

### APPLICATIONS

- Primary Side Switch for High Density DC/DC
- Telecom/Server 48-V DC/DC
- Industrial and 42-V Automotive

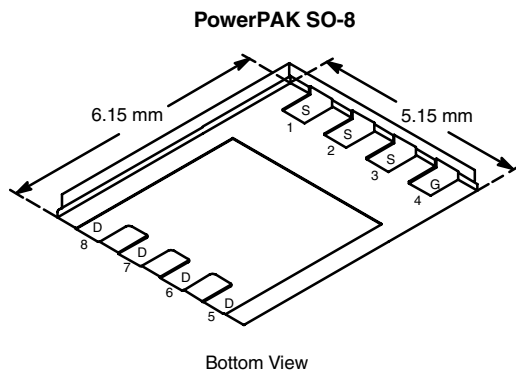

Ordering Information: Si7846DP-T1  
Si7846DP-T1—E3 (Lead (Pb)-free)

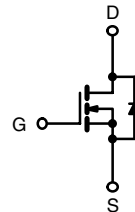

N-Channel MOSFET

### ABSOLUTE MAXIMUM RATINGS $T_A = 25^\circ\text{C}$ , unless otherwise noted

Parameter	Symbol	10 secs	Steady State	Unit	
Drain-Source Voltage	$V_{DS}$	150		V	
Gate-Source Voltage	$V_{GS}$	$\pm 20$			
Continuous Drain Current ( $T_J = 150^\circ\text{C}$ ) <sup>a</sup>	$I_D$	$T_C = 25^\circ\text{C}$		A	
		$T_C = 70^\circ\text{C}$			
		6.7	4.0		
		5.4	3.3		
Pulsed Drain Current	$I_{DM}$	50		A	
Avalanche Current	$I_{AS}$	25			
Continuous Source Current (Diode Conduction) <sup>a</sup>	$I_S$	4.3	1.6	W	
Maximum Power Dissipation <sup>a</sup>	$P_D$	$T_A = 25^\circ\text{C}$	5.2		1.9
		$T_A = 70^\circ\text{C}$	3.3		1.2
Operating Junction and Storage Temperature Range	$T_J, T_{stg}$	- 55 to 150		$^\circ\text{C}$	
Soldering Recommendations (Peak Temperature) <sup>b,c</sup>		260			

### THERMAL RESISTANCE RATINGS

Parameter	Symbol	Typical	Maximum	Unit	
Maximum Junction-to-Ambient <sup>a</sup>	$R_{thJA}$	$t \leq 10$ sec	19	24	$^\circ\text{C/W}$
		Steady State	52	65	
Maximum Junction-to-Case (Drain)	$R_{thJC}$	1.5	1.8		

#### Notes

a. Surface Mounted on 1" x 1" FR4 Board.

b. See Solder Profile (<http://www.vishay.com/ppg?73257>). The PowerPAK SO-8 is a leadless package. The end of the lead terminal is exposed copper (not plated) as a result of the singulation process in manufacturing. A solder fillet at the exposed copper tip cannot be guaranteed and is not required to ensure adequate bottom side solder interconnection.

c. Rework Conditions: manual soldering with a soldering iron is not recommended for leadless components.

\* Pb containing terminations are not RoHS compliant, exemptions may apply.

<b>SPECIFICATIONS</b> $T_J = 25\text{ }^\circ\text{C}$ , unless otherwise noted						
Parameter	Symbol	Test Condition	Min	Typ	Max	Unit
<b>Static</b>						
Gate Threshold Voltage	$V_{GS(th)}$	$V_{DS} = V_{GS}, I_D = 250\text{ }\mu\text{A}$	2.0		4.5	V
Gate-Body Leakage	$I_{GSS}$	$V_{DS} = 0\text{ V}, V_{GS} = \pm 20\text{ V}$			$\pm 100$	nA
Zero Gate Voltage Drain Current	$I_{DSS}$	$V_{DS} = 150\text{ V}, V_{GS} = 0\text{ V}$			1	$\mu\text{A}$
		$V_{DS} = 150\text{ V}, V_{GS} = 0\text{ V}, T_J = 55\text{ }^\circ\text{C}$			5	
On-State Drain Current <sup>a</sup>	$I_{D(on)}$	$V_{DS} \geq 5\text{ V}, V_{GS} = 10\text{ V}$	50			A
Drain-Source On-State Resistance <sup>a</sup>	$r_{DS(on)}$	$V_{GS} = 10\text{ V}, I_D = 5\text{ A}$		0.041	0.050	$\Omega$
Forward Transconductance <sup>a</sup>	$g_{fs}$	$V_{DS} = 15\text{ V}, I_D = 5\text{ A}$		18		S
Diode Forward Voltage <sup>a</sup>	$V_{SD}$	$I_S = 2.8\text{ A}, V_{GS} = 0\text{ V}$		0.75	1.1	V
<b>Dynamic<sup>b</sup></b>						
Total Gate Charge	$Q_g$	$V_{DS} = 75\text{ V}, V_{GS} = 10\text{ V}, I_D = 5\text{ A}$		30	36	nC
Gate-Source Charge	$Q_{gs}$		8.5			
Gate-Drain Charge	$Q_{gd}$		8.5			
Gate Resistance	$R_g$		0.2	0.85	1.4	$\Omega$
Turn-On Delay Time	$t_{d(on)}$	$V_{DD} = 75\text{ V}, R_L = 15\text{ }\Omega$ $I_D \approx 5\text{ A}, V_{GEN} = 10\text{ V}, R_G = 6\text{ }\Omega$		12	18	ns
Rise Time	$t_r$		7	11		
Turn-Off Delay Time	$t_{d(off)}$		22	33		
Fall Time	$t_f$		10	15		
Source-Drain Reverse Recovery Time	$t_{rr}$	$I_F = 2.8\text{ A}, di/dt = 100\text{ A}/\mu\text{s}$		40	70	

Notes

- a. Pulse test; pulse width  $\leq 300\text{ }\mu\text{s}$ , duty cycle  $\leq 2\%$ .
- b. Guaranteed by design, not subject to production testing.

Stresses beyond those listed under "Absolute Maximum Ratings" may cause permanent damage to the device. These are stress ratings only, and functional operation of the device at these or any other conditions beyond those indicated in the operational sections of the specifications is not implied. Exposure to absolute maximum rating conditions for extended periods may affect device reliability.

**TYPICAL CHARACTERISTICS**  $25\text{ }^\circ\text{C}$ , unless noted

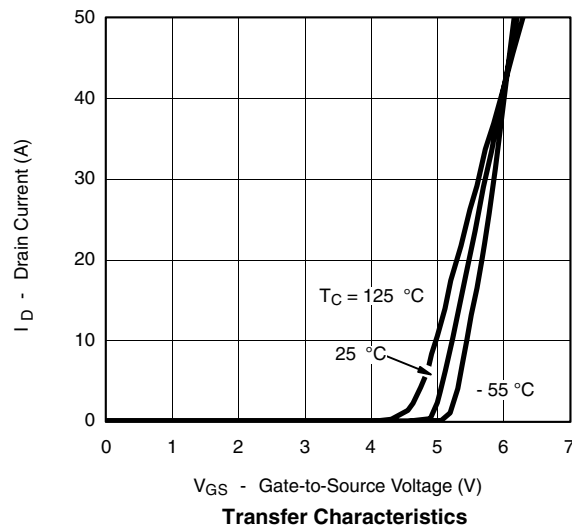
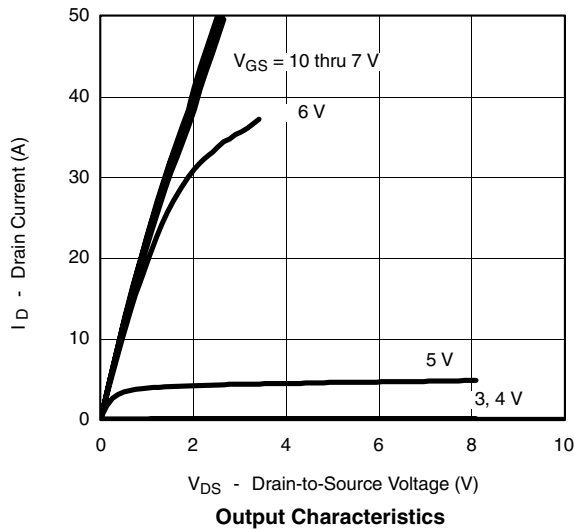

**TYPICAL CHARACTERISTICS** 25 °C, unless noted

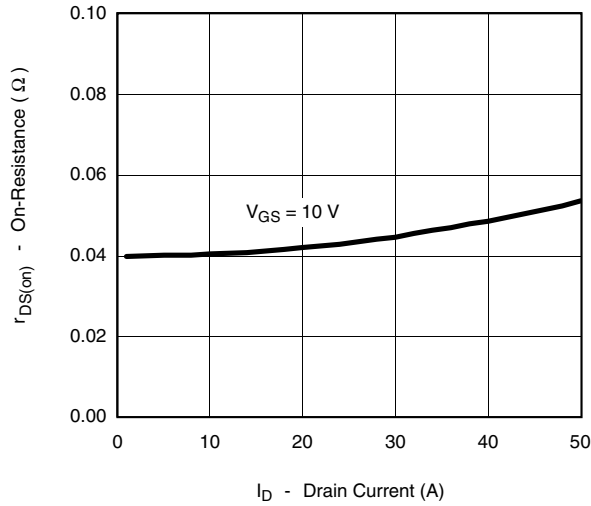

**On-Resistance vs. Drain Current**

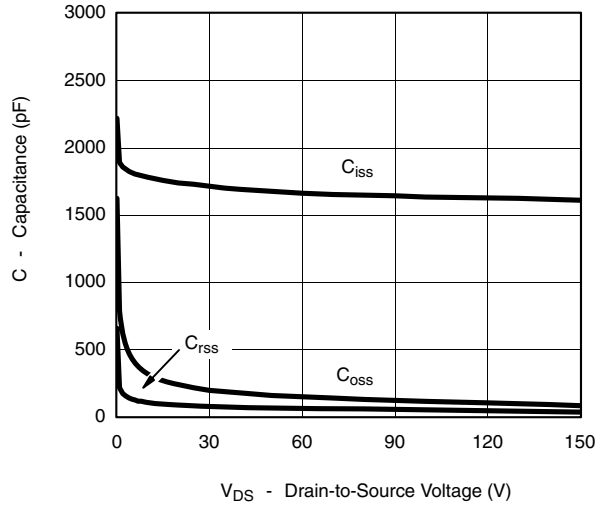

**Capacitance**

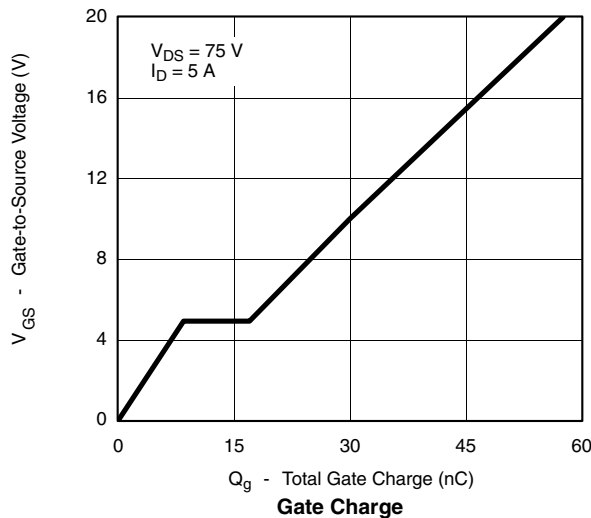

**Gate Charge**

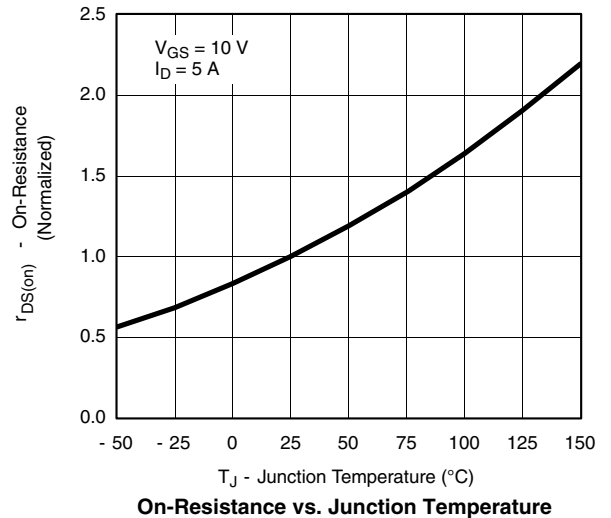

**On-Resistance vs. Junction Temperature**

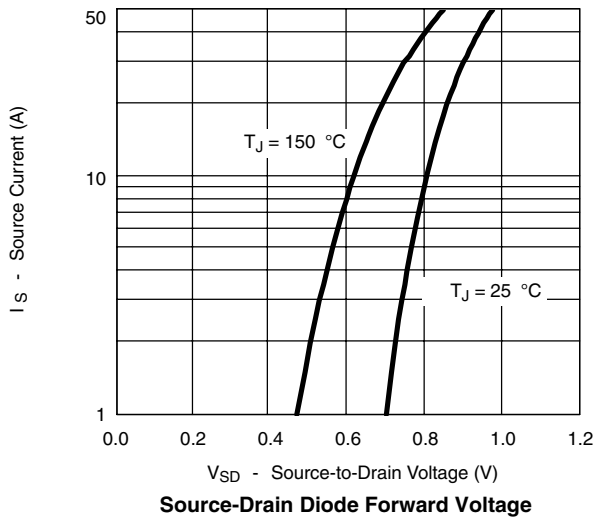

**Source-Drain Diode Forward Voltage**

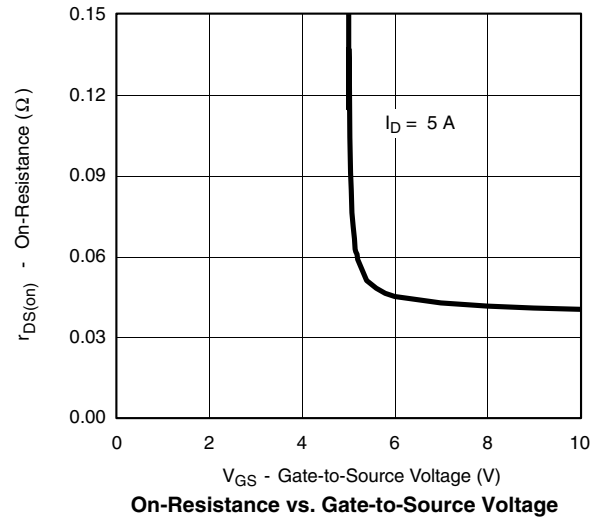

**On-Resistance vs. Gate-to-Source Voltage**

**TYPICAL CHARACTERISTICS** 25 °C, unless noted

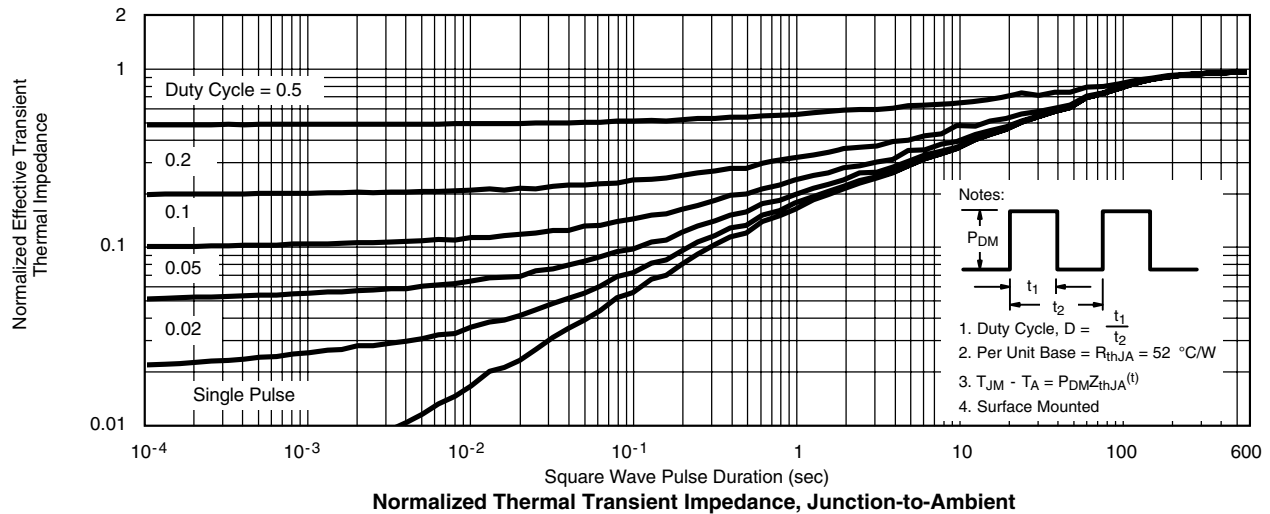
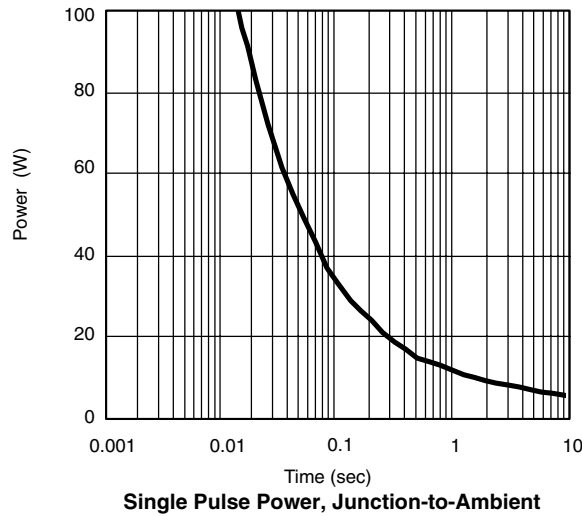
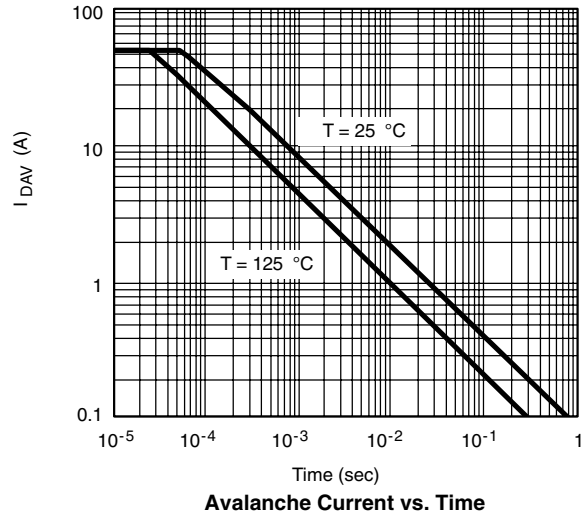
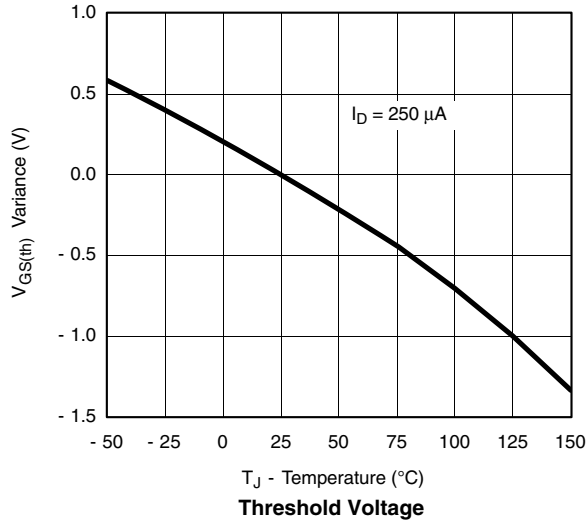



**TYPICAL CHARACTERISTICS** 25 °C, unless noted

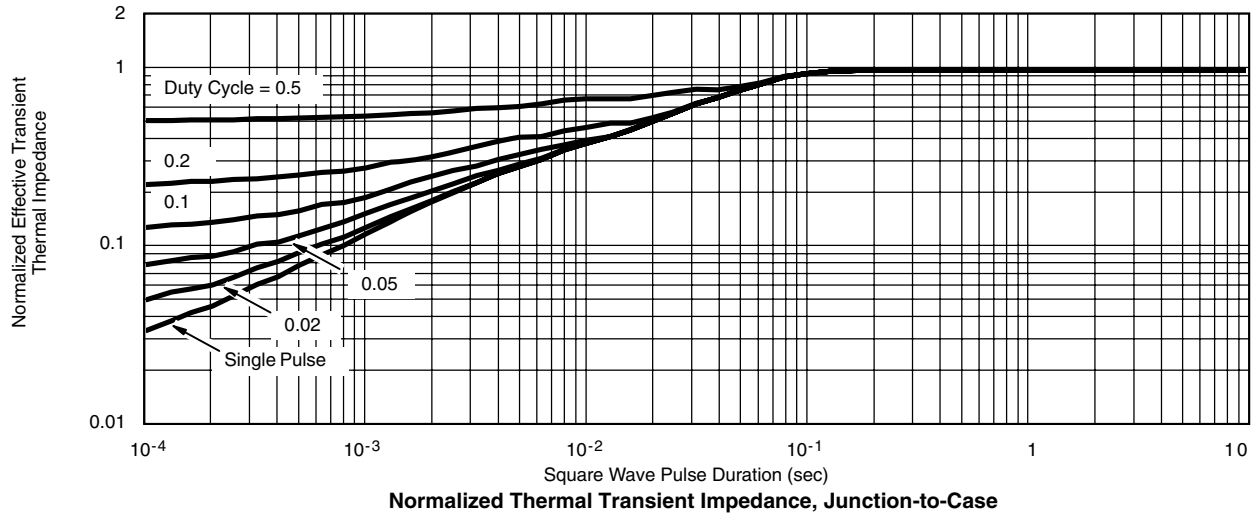

Vishay Siliconix maintains worldwide manufacturing capability. Products may be manufactured at one of several qualified locations. Reliability data for Silicon Technology and Package Reliability represent a composite of all qualified locations. For related documents such as package/tape drawings, part marking, and reliability data, see <http://www.vishay.com/ppg?71442>.



## Notice

Specifications of the products displayed herein are subject to change without notice. Vishay Intertechnology, Inc., or anyone on its behalf, assumes no responsibility or liability for any errors or inaccuracies.

Information contained herein is intended to provide a product description only. No license, express or implied, by estoppel or otherwise, to any intellectual property rights is granted by this document. Except as provided in Vishay's terms and conditions of sale for such products, Vishay assumes no liability whatsoever, and disclaims any express or implied warranty, relating to sale and/or use of Vishay products including liability or warranties relating to fitness for a particular purpose, merchantability, or infringement of any patent, copyright, or other intellectual property right.

The products shown herein are not designed for use in medical, life-saving, or life-sustaining applications. Customers using or selling these products for use in such applications do so at their own risk and agree to fully indemnify Vishay for any damages resulting from such improper use or sale.