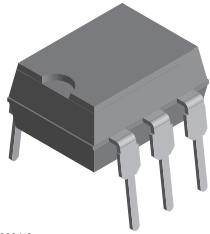
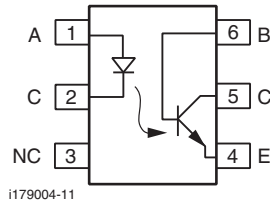


Optocoupler, Phototransistor Output, with Base Connection



i179004-3



i179004-11

DESCRIPTION

The SFH601 is an optocoupler with a gallium arsenide LED emitter which is optically coupled with a silicon planar phototransistor detector. The component is packaged in a plastic plug-in case 20 AB DIN 41866.

The coupler transmits signals between two electrically isolated circuits.

FEATURES

- Isolation test voltage (1.0 s), 5300 V_{RMS}
- V_{CEsat} 0.25 (≤ 0.4) V, I_F = 10 mA, I_C = 2.5 mA
- Built to conform to VDE requirements
- Highest quality premium device
- Long term stability
- Storage temperature, -55 ° to +150 °C
- Material categorization: for definitions of compliance please see www.vishay.com/doc?99912

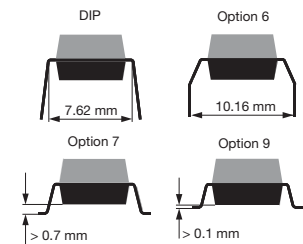
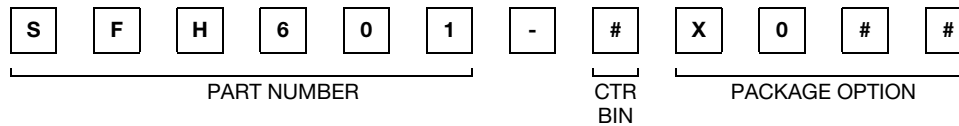


RoHS
COMPLIANT

AGENCY APPROVALS

- UL1577, file no. E52744 system code H or J, double protection
- DIN EN 60747-5-5 (VDE 0884-5) available with option 1
- CSA 93751
- BSI IEC 60950; IEC 60065

ORDERING INFORMATION



AGENCY CERTIFIED/PACKAGE	CTR (%)			
	40 to 80	63 to 125	100 to 200	160 to 320
UL, BSI, CSA	40 to 80	63 to 125	100 to 200	160 to 320
DIP-6	SFH601-1	SFH601-2	SFH601-3	SFH601-4
DIP-6, 400 mil, option 6	SFH601-1X006	SFH601-2X006	SFH601-3X006	SFH601-4X006
SMD-6, option 7	SFH601-1X007	SFH601-2X007T	SFH601-3X007(T)	SFH601-4X007(T)
SMD-6, option 9	SFH601-1X009T	SFH601-2X009	SFH601-3X009	SFH601-4X009(T)
VDE, cUL, UL, BSI	40 to 80	63 to 125	100 to 200	160 to 320
DIP-6, option 1	SFH601-1X001	SFH601-2X001	-	SFH601-4X001
DIP-6, 400 mil, option 6	SFH601-1X016	-	SFH601-3X016	SFH601-4X016
SMD-6, option 7	SFH601-1X017	SFH601-2X017(T)	SFH601-3X017(T)	-
SMD-6, option 9	-	-	SFH601-3X019(T)	-

Note

- For additional information on the available options refer to option information.



ABSOLUTE MAXIMUM RATINGS ($T_{amb} = 25\text{ }^{\circ}\text{C}$, unless otherwise specified)				
PARAMETER	TEST CONDITION	SYMBOL	VALUE	UNIT
INPUT				
Reverse voltage		V_R	6	V
DC forward current		I_F	60	mA
Surge forward current	$t = 10\text{ }\mu\text{s}$	I_{FSM}	2.5	A
Total power dissipation		P_{diss}	100	mW
OUTPUT				
Collector emitter voltage		V_{CEO}	100	V
Emitter base voltage		V_{EBO}	7	V
Collector current		I_C	50	mA
	$t = 1.0\text{ ms}$	I_C	100	mA
Power dissipation		P_{diss}	150	mW
COUPLER				
Storage temperature range		T_{stg}	-55 to +150	$^{\circ}\text{C}$
Ambient temperature range		T_{amb}	-55 to +100	$^{\circ}\text{C}$
Junction temperature		T_j	100	$^{\circ}\text{C}$
Soldering temperature ⁽¹⁾	Max. 10 s, dip soldering: distance to seating plane $\geq 1.5\text{ mm}$	T_{sld}	260	$^{\circ}\text{C}$

Notes

- Stresses in excess of the absolute maximum ratings can cause permanent damage to the device. Functional operation of the device is not implied at these or any other conditions in excess of those given in the operational sections of this document. Exposure to absolute maximum ratings for extended periods of the time can adversely affect reliability.
- ⁽¹⁾ Refer to reflow profile for soldering conditions for surface mounted devices (SMD). Refer to wave profile for soldering conditions for through hole devices (DIP).

ELECTRICAL CHARACTERISTICS ($T_{amb} = 25\text{ }^{\circ}\text{C}$, unless otherwise specified)							
PARAMETER	TEST CONDITION	PART	SYMBOL	MIN.	TYP.	MAX.	UNIT
INPUT							
Forward voltage	$I_F = 60\text{ mA}$		V_F	-	1.25	1.65	V
Breakdown voltage	$I_R = 10\text{ }\mu\text{A}$		V_{BR}	6	-	-	V
Reverse current	$V_R = 6\text{ V}$		I_R	-	0.01	10	μA
Capacitance	$V_F = 0\text{ V}$, $f = 1\text{ MHz}$		C_O	-	25	-	pF
Thermal resistance			R_{thja}	-	750	-	K/W
OUTPUT							
Collector emitter capacitance	$f = 1\text{ MHz}$, $V_{CE} = 5\text{ V}$		C_{CE}	-	6.8	-	pF
Collector base capacitance	$f = 1\text{ MHz}$, $V_{CB} = 5\text{ V}$		C_{CB}	-	8.5	-	pF
Emitter base capacitance	$f = 1\text{ MHz}$, $V_{EB} = 5\text{ V}$		C_{EB}	-	11	-	pF
Thermal resistance			R_{thja}	-	500	-	K/W
Collector emitter leakage current	$V_{CE} = 10\text{ V}$	SFH601-1	I_{CEO}	-	2	50	nA
		SFH601-2	I_{CEO}	-	2	50	nA
		SFH601-3	I_{CEO}	-	5	100	nA
		SFH601-4	I_{CEO}	-	5	100	nA
COUPLER							
Saturation voltage collector emitter	$I_F = 10\text{ mA}$, $I_C = 2.5\text{ mA}$		V_{CEsat}	-	0.25	0.4	V
Capacitance (input to output)	$V_{I-O} = 0$, $f = 1\text{ MHz}$		C_{IO}	-	0.6	-	pF

Note

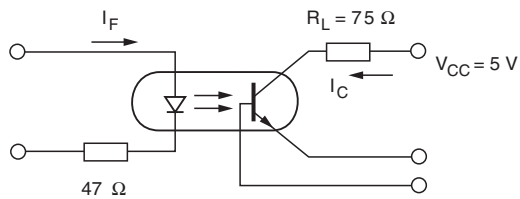
- Minimum and maximum values are testing requirements. Typical values are characteristics of the device and are the result of engineering evaluation. Typical values are for information only and are not part of the testing requirements.

CURRENT TRANSFER RATIO							
PARAMETER	TEST CONDITION	PART	SYMBOL	MIN.	TYP.	MAX.	UNIT
I_C/I_F at $V_{CE} = 5.0$ V	$I_F = 10$ mA	SFH601-1	CTR	40	-	80	%
		SFH601-2	CTR	63	-	125	%
		SFH601-3	CTR	100	-	200	%
		SFH601-4	CTR	160	-	320	%
	$I_F = 1$ mA	SFH601-1	CTR	13	30	-	%
		SFH601-2	CTR	22	45	-	%
		SFH601-3	CTR	34	70	-	%
		SFH601-4	CTR	56	90	-	%

Note

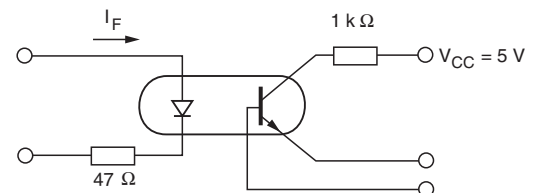
- Current transfer ratio and collector emitter leakage current by dash number.

SWITCHING CHARACTERISTICS							
PARAMETER	TEST CONDITION	PART	SYMBOL	MIN.	TYP.	MAX.	UNIT
NON-SATURATED							
Current	$V_{CC} = 5$ V, $R_L = 75$ Ω		I_F	-	10	-	mA
Rise time	$V_{CC} = 5$ V, $R_L = 75$ Ω		t_r	-	2	-	μ s
Fall time	$V_{CC} = 5$ V, $R_L = 75$ Ω		t_f	-	2	-	μ s
Turn-on time	$V_{CC} = 5$ V, $R_L = 75$ Ω		t_{on}	-	3	-	μ s
Turn-off time	$V_{CC} = 5$ V, $R_L = 75$ Ω		t_{off}	-	2.3	-	μ s
SATURATED							
Current		SFH601-1	I_F	-	20	-	mA
		SFH601-2	I_F	-	10	-	mA
		SFH601-3	I_F	-	10	-	mA
		SFH601-4	I_F	-	0.5	-	mA
Rise time		SFH601-1	t_r	-	2	-	μ s
		SFH601-2	t_r	-	3	-	μ s
		SFH601-3	t_r	-	3	-	μ s
		SFH601-4	t_r	-	4.6	-	μ s
Fall time		SFH601-1	t_f	-	11	-	μ s
		SFH601-2	t_f	-	14	-	μ s
		SFH601-3	t_f	-	14	-	μ s
		SFH601-4	t_f	-	15	-	μ s
Turn-on time		SFH601-1	t_{on}	-	3	-	μ s
		SFH601-2	t_{on}	-	4.2	-	μ s
		SFH601-3	t_{on}	-	4.2	-	μ s
		SFH601-4	t_{on}	-	6	-	μ s
Turn-off time		SFH601-1	t_{off}	-	18	-	μ s
		SFH601-2	t_{off}	-	23	-	μ s
		SFH601-3	t_{off}	-	23	-	μ s
		SFH601-4	t_{off}	-	25	-	μ s



isfh601_01

Fig. 1 - Linear Operation (without Saturation)



isfh601_02

Fig. 2 - Switching Operation (with Saturation)

SAFETY AND INSULATION RATINGS				
PARAMETER	TEST CONDITION	SYMBOL	VALUE	UNIT
Climatic classification	According to IEC 68 part 1		55 / 100 / 21	
Comparative tracking index		CTI	175	
Maximum rated withstanding isolation voltage	t = 1 min	V_{ISO}	4420	V_{RMS}
Maximum transient isolation voltage		V_{IOTM}	8000	V
Maximum repetitive peak isolation voltage		V_{IORM}	890	V
Isolation resistance	$V_{IO} = 500\text{ V}, T_{amb} = 25\text{ }^{\circ}\text{C}$	R_{IO}	$\geq 10^{12}$	Ω
	$V_{IO} = 500\text{ V}, T_{amb} = 100\text{ }^{\circ}\text{C}$	R_{IO}	$\geq 10^{11}$	Ω
Output safety power		P_{SO}	700	mW
Input safety current		I_{SI}	400	mA
Input safety temperature		T_{SI}	175	$^{\circ}\text{C}$
Creepage distance	Standard DIP-4		≥ 7	mm
Clearance distance	Standard DIP-4		≥ 7	mm
Creepage distance	400 mil DIP-4		≥ 8	mm
Clearance distance	400 mil DIP-4		≥ 8	mm
Insulation thickness		DTI	≥ 0.4	mm

Note

- As per IEC 60747-5-5, § 7.4.3.8.2, this optocoupler is suitable for “safe electrical insulation” only within the safety ratings. Compliance with the safety ratings shall be ensured by means of protective circuits.

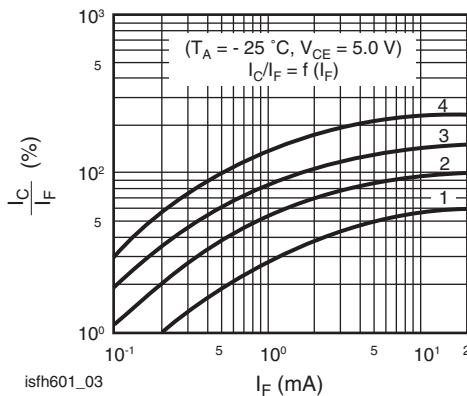
TYPICAL CHARACTERISTICS ($T_{amb} = 25\text{ }^{\circ}\text{C}$, unless otherwise specified)


Fig. 3 - Current Transfer Ratio vs. Diode Current

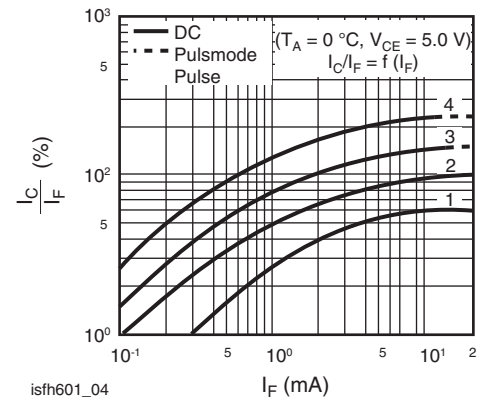


Fig. 4 - Current Transfer Ratio vs. Diode Current

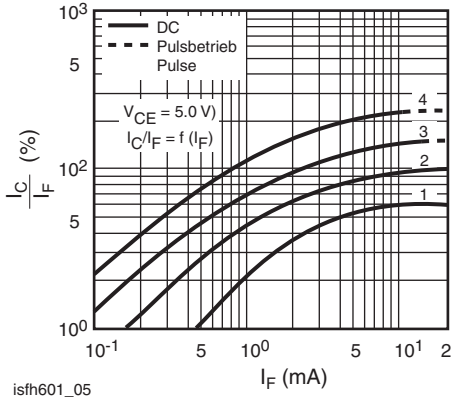


Fig. 5 - Current Transfer Ratio vs. Diode Current

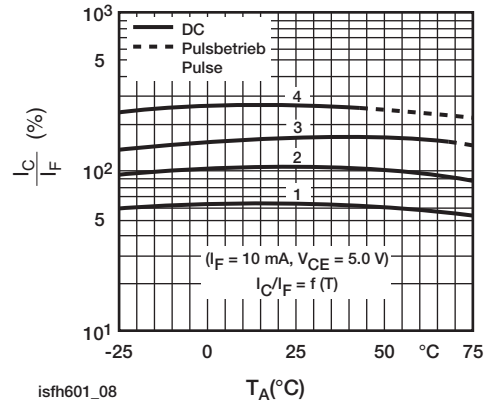


Fig. 8 - Current Transfer Ratio vs. Diode Current

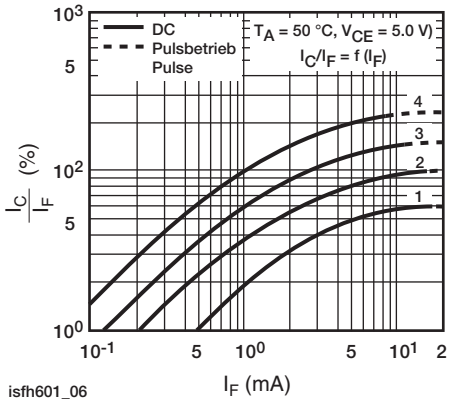


Fig. 6 - Current Transfer Ratio vs. Diode Current

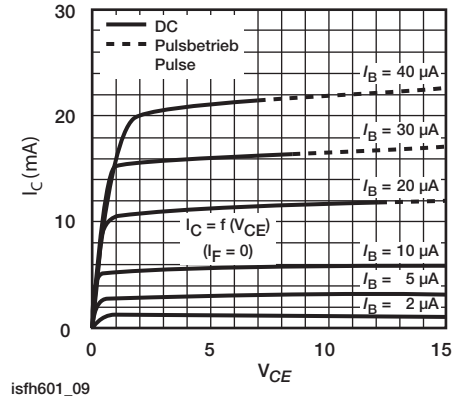


Fig. 9 - Transistor Characteristics

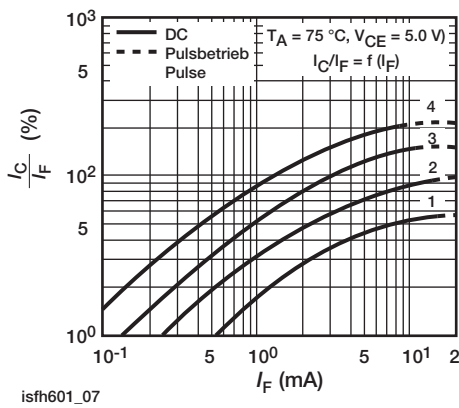


Fig. 7 - Current Transfer Ratio vs. Diode Current

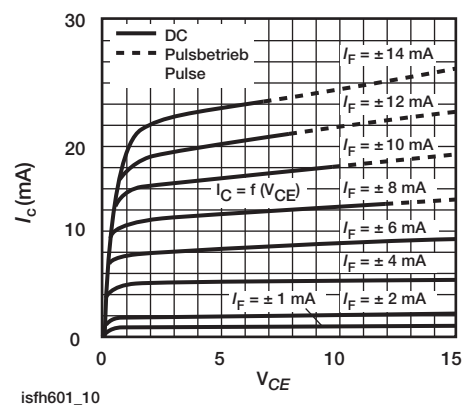


Fig. 10 - Output Characteristics

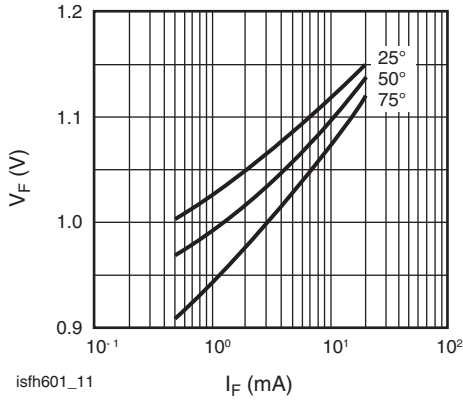


Fig. 11 - Forward Voltage

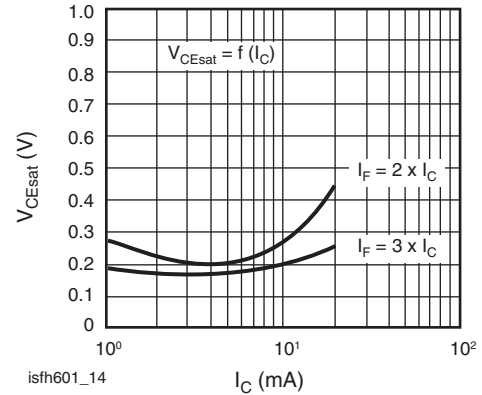


Fig. 14 - Saturation Voltage vs. Collector Current and Modulation Depth SFH601-2

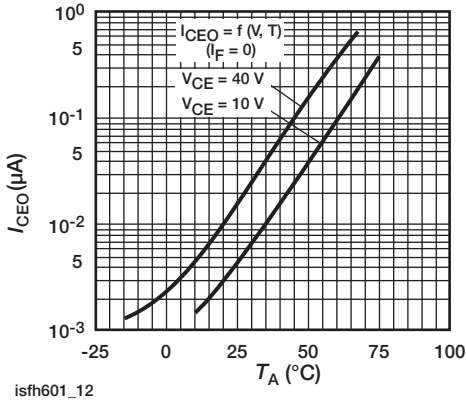


Fig. 12 - Collector Emitter Off-state Current

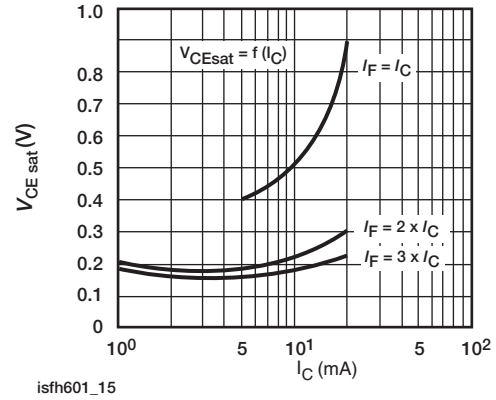


Fig. 15 - Saturation Voltage vs. Collector Current and Modulation Depth SFH601-3

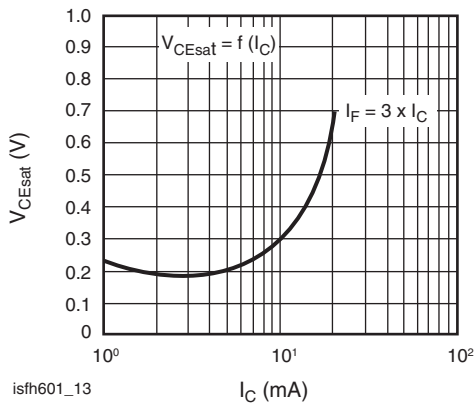


Fig. 13 - Saturation Voltage vs. Collector Current and Modulation Depth SFH601-1

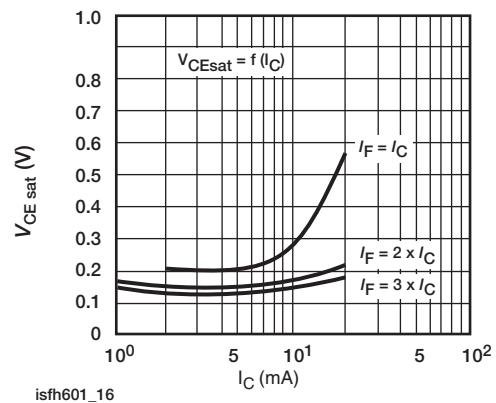


Fig. 16 - Saturation Voltage vs. Collector Current and Modulation Depth SFH601-4

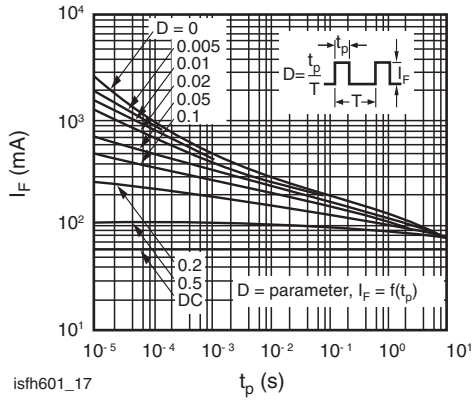


Fig. 17 - Permissible Pulse Load

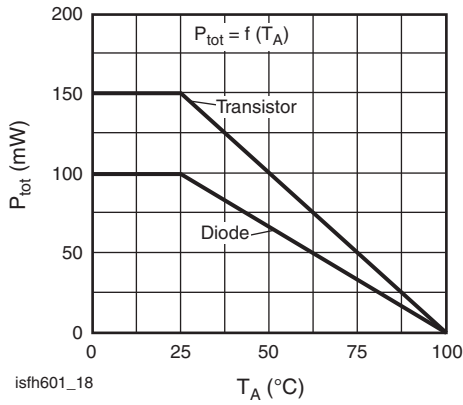


Fig. 18 - Permissible Power Dissipation for Transistor and Diode

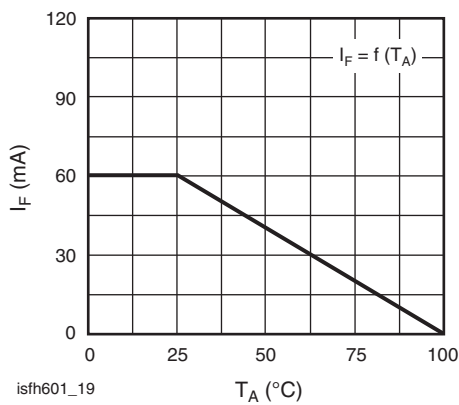
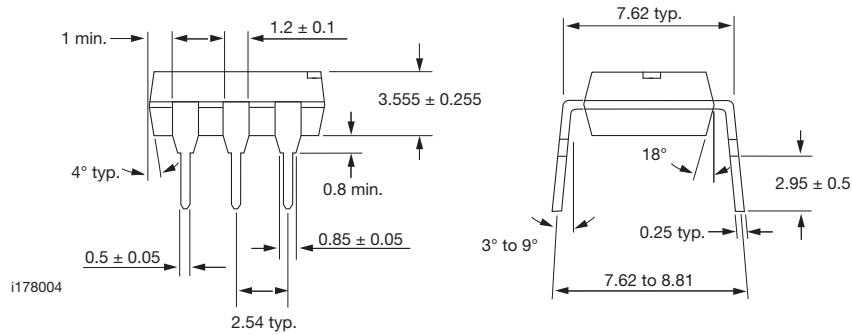
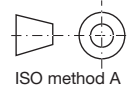
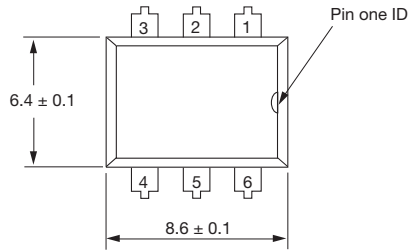


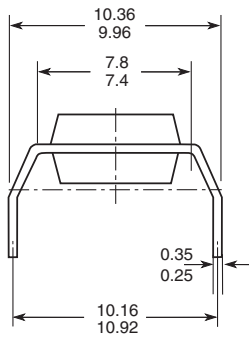
Fig. 19 - Permissible Forward Current Diode



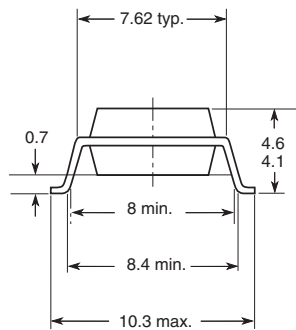
PACKAGE DIMENSIONS in inches (millimeters)



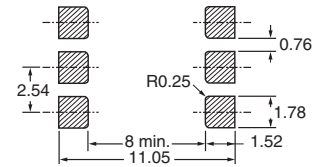
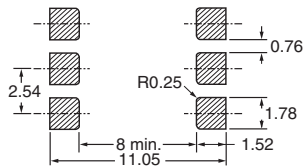
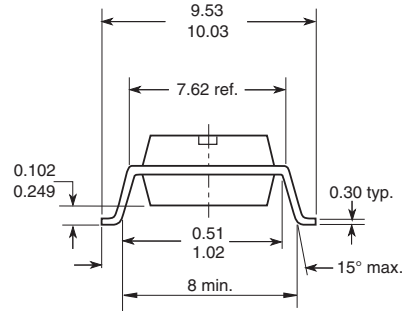
Option 6



Option 7



Option 9

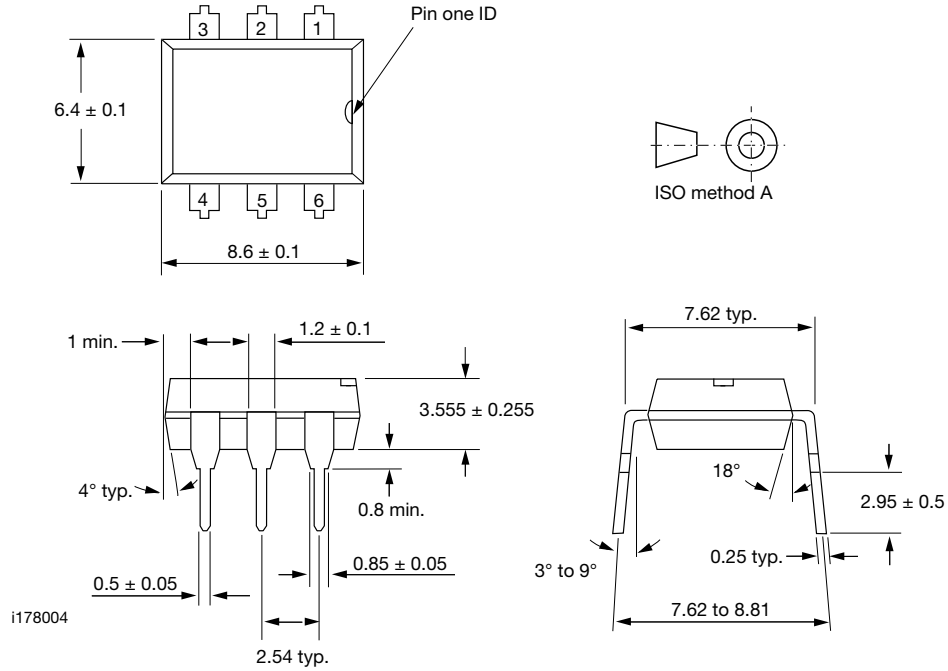


18450-16



DIP-6A

PACKAGE DIMENSIONS in inches (millimeters)



Note

The information in this document provides generic information but for specific information on a product the appropriate product datasheet should be used.



Disclaimer

ALL PRODUCT, PRODUCT SPECIFICATIONS AND DATA ARE SUBJECT TO CHANGE WITHOUT NOTICE TO IMPROVE RELIABILITY, FUNCTION OR DESIGN OR OTHERWISE.

Vishay Intertechnology, Inc., its affiliates, agents, and employees, and all persons acting on its or their behalf (collectively, "Vishay"), disclaim any and all liability for any errors, inaccuracies or incompleteness contained in any datasheet or in any other disclosure relating to any product.

Vishay makes no warranty, representation or guarantee regarding the suitability of the products for any particular purpose or the continuing production of any product. To the maximum extent permitted by applicable law, Vishay disclaims (i) any and all liability arising out of the application or use of any product, (ii) any and all liability, including without limitation special, consequential or incidental damages, and (iii) any and all implied warranties, including warranties of fitness for particular purpose, non-infringement and merchantability.

Statements regarding the suitability of products for certain types of applications are based on Vishay's knowledge of typical requirements that are often placed on Vishay products in generic applications. Such statements are not binding statements about the suitability of products for a particular application. It is the customer's responsibility to validate that a particular product with the properties described in the product specification is suitable for use in a particular application. Parameters provided in datasheets and / or specifications may vary in different applications and performance may vary over time. All operating parameters, including typical parameters, must be validated for each customer application by the customer's technical experts. Product specifications do not expand or otherwise modify Vishay's terms and conditions of purchase, including but not limited to the warranty expressed therein.

Except as expressly indicated in writing, Vishay products are not designed for use in medical, life-saving, or life-sustaining applications or for any other application in which the failure of the Vishay product could result in personal injury or death. Customers using or selling Vishay products not expressly indicated for use in such applications do so at their own risk. Please contact authorized Vishay personnel to obtain written terms and conditions regarding products designed for such applications.

No license, express or implied, by estoppel or otherwise, to any intellectual property rights is granted by this document or by any conduct of Vishay. Product names and markings noted herein may be trademarks of their respective owners.