

# 4V Drive Nch+Nch MOSFET

## SP8K5

### ●Structure

Silicon N-channel MOSFET

### ●Features

- 1) Low on-resistance.
- 2) Built-in G-S Protection Diode.
- 3) Small surface Mount Package (SOP8).

### ●Application

Power switching, DC / DC converter.

### ●Dimensions (Unit : mm)

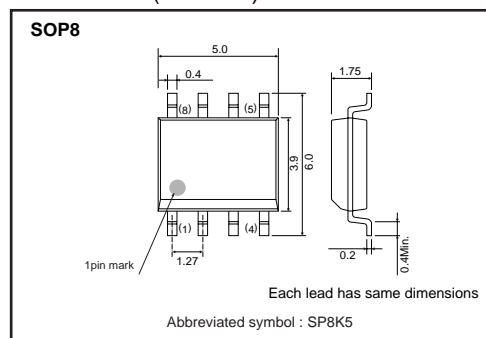

### ●Packaging specifications

Type	Package	Taping
	Code	TB
	Basic ordering unit (pieces)	2500
SP8K5		○

### ●Equivalent circuit

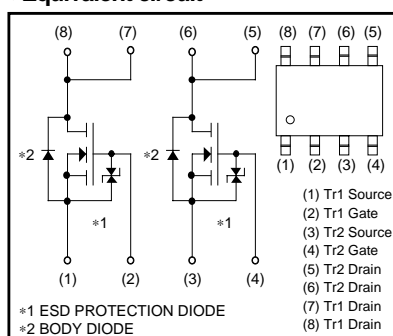

\*A protection diode is included between the gate and the source terminals to protect the diode against static electricity when the product is in use. Use the protection circuit when the fixed voltages are exceeded.

### ●Absolute maximum ratings (Ta=25°C)

<It is the same ratings for the Tr1 and Tr2.>

Parameter	Symbol	Limits	Unit	
Drain-source voltage	$V_{DSS}$	30	V	
Gate-source voltage	$V_{GSS}$	$\pm 20$	V	
Drain current	Continuous	$I_D$	$\pm 3.5$	A
	Pulsed	$I_{DP}$ *1	$\pm 14$	A
Source current (Body diode)	Continuous	$I_S$	1.6	A
	Pulsed	$I_{SP}$ *1	6.4	A
Total power dissipation	$P_D$ *2	2	W	
Channel temperature	$T_{ch}$	150	°C	
Storage temperature	$T_{stg}$	-55 to +150	°C	

\*1  $P_w \leq 10 \mu s$ , Duty cycle  $\leq 1\%$

\*2 MOUNTED ON A CERAMIC BOARD.

### ●Thermal resistance

Parameter	Symbol	Limits	Unit
Channel to ambient	$R_{th(ch-a)}$ *	62.5	°C / W

\*MOUNTED ON A CERAMIC BOARD.

## Transistors

## ●Electrical characteristics (Ta=25°C)

&lt;It is the same characteristics for the Tr1 and Tr2.&gt;

Parameter	Symbol	Min.	Typ.	Max.	Unit	Conditions
Gate-source leakage	I <sub>GSS</sub>	–	–	±10	μA	V <sub>GS</sub> =±20V, V <sub>DS</sub> =0V
Drain-source breakdown voltage	V <sub>(BR) DSS</sub>	30	–	–	V	I <sub>D</sub> =1mA, V <sub>GS</sub> =0V
Zero gate voltage drain current	I <sub>DSS</sub>	–	–	1	μA	V <sub>DS</sub> =30V, V <sub>GS</sub> =0V
Gate threshold voltage	V <sub>GS(th)</sub>	1.0	–	2.5	V	V <sub>DS</sub> =10V, I <sub>D</sub> =1mA
Static drain-source on-state resistance	R <sub>DS(on)</sub> *	–	59	83	mΩ	I <sub>D</sub> =3.5A, V <sub>GS</sub> =10V
		–	93	130		I <sub>D</sub> =3.5A, V <sub>GS</sub> =4.5V
		–	107	150		I <sub>D</sub> =3.5A, V <sub>GS</sub> =4V
Forward transfer admittance	Y <sub>fs</sub>  *	2.0	–	–	S	I <sub>D</sub> =3.5A, V <sub>DS</sub> =10V
Input capacitance	C <sub>iss</sub>	–	140	–	pF	V <sub>DS</sub> =10V
Output capacitance	C <sub>oss</sub>	–	45	–	pF	V <sub>GS</sub> =0V
Reverse transfer capacitance	C <sub>rss</sub>	–	30	–	pF	f=1MHz
Turn-on delay time	t <sub>d(on)</sub> *	–	6	–	ns	I <sub>D</sub> =1.75A, V <sub>DD</sub> ≐15V
Rise time	t <sub>r</sub> *	–	6	–	ns	V <sub>GS</sub> =10V
Turn-off delay time	t <sub>d(off)</sub> *	–	17	–	ns	R <sub>L</sub> =8.57Ω
Fall time	t <sub>f</sub> *	–	4	–	ns	R <sub>G</sub> =10Ω
Total gate charge	Q <sub>g</sub> *	–	2.5	3.5	nC	V <sub>DD</sub> ≐15V
Gate-source charge	Q <sub>gs</sub> *	–	0.8	–	nC	V <sub>GS</sub> =5V
Gate-drain charge	Q <sub>gd</sub> *	–	0.8	–	nC	I <sub>D</sub> =3.5A

\*Pulsed

## ●Body diode characteristics (Source-drain) (Ta=25°C)

&lt;It is the same characteristics for the Tr1 and Tr2.&gt;

Parameter	Symbol	Min.	Typ.	Max.	Unit	Conditions
Forward voltage	V <sub>SD</sub> *	–	–	1.2	V	I <sub>S</sub> =6.4A, V <sub>GS</sub> =0V

\*Pulsed

Transistors

●Electrical characteristic curves

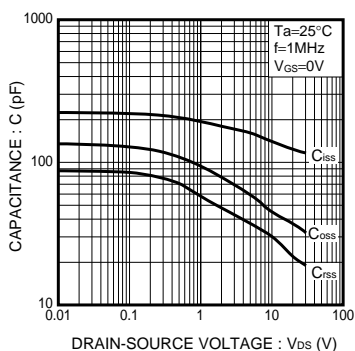

Fig.1 Typical Capacitance vs. Drain-Source Voltage

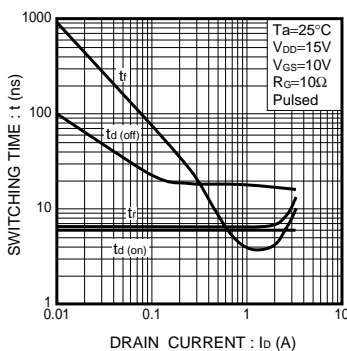

Fig.2 Switching Characteristics

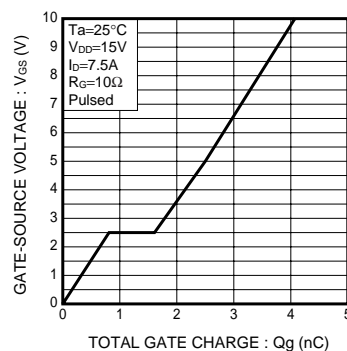

Fig.3 Dynamic Input Characteristics

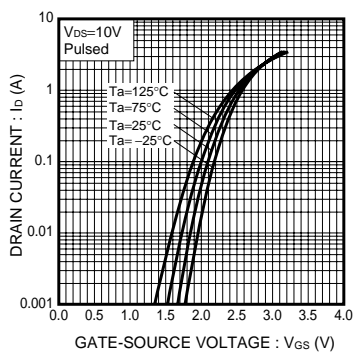

Fig.4 Typical Transfer Characteristics

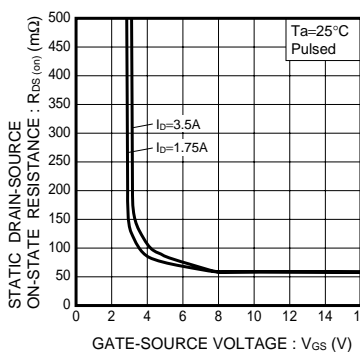

Fig.5 Static Drain-Source On-State Resistance vs. Gate-Source Voltage

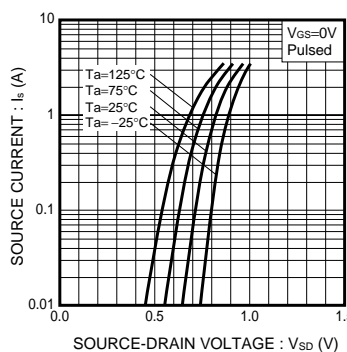

Fig.6 Source Current vs. Source-Drain Voltage

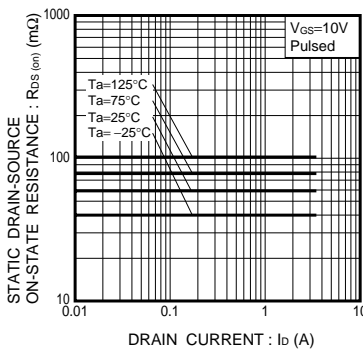

Fig.7 Static Drain-Source On-State Resistance vs. Drain Current (I)

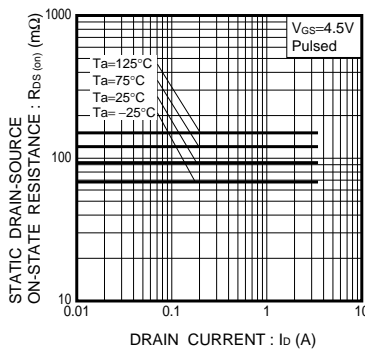

Fig.8 Static Drain-Source On-State Resistance vs. Drain Current (II)

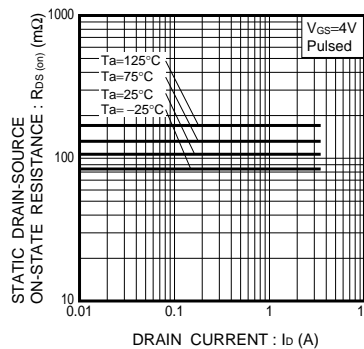

Fig.9 Static Drain-Source On-State Resistance vs. Drain Current (III)

### Notes

- No technical content pages of this document may be reproduced in any form or transmitted by any means without prior permission of ROHM CO.,LTD.
- The contents described herein are subject to change without notice. The specifications for the product described in this document are for reference only. Upon actual use, therefore, please request that specifications to be separately delivered.
- Application circuit diagrams and circuit constants contained herein are shown as examples of standard use and operation. Please pay careful attention to the peripheral conditions when designing circuits and deciding upon circuit constants in the set.
- Any data, including, but not limited to application circuit diagrams information, described herein are intended only as illustrations of such devices and not as the specifications for such devices. ROHM CO.,LTD. disclaims any warranty that any use of such devices shall be free from infringement of any third party's intellectual property rights or other proprietary rights, and further, assumes no liability of whatsoever nature in the event of any such infringement, or arising from or connected with or related to the use of such devices.
- Upon the sale of any such devices, other than for buyer's right to use such devices itself, resell or otherwise dispose of the same, no express or implied right or license to practice or commercially exploit any intellectual property rights or other proprietary rights owned or controlled by
- ROHM CO., LTD. is granted to any such buyer.
- Products listed in this document are no antiradiation design.

The products listed in this document are designed to be used with ordinary electronic equipment or devices (such as audio visual equipment, office-automation equipment, communications devices, electrical appliances and electronic toys).

Should you intend to use these products with equipment or devices which require an extremely high level of reliability and the malfunction of which would directly endanger human life (such as medical instruments, transportation equipment, aerospace machinery, nuclear-reactor controllers, fuel controllers and other safety devices), please be sure to consult with our sales representative in advance.

It is our top priority to supply products with the utmost quality and reliability. However, there is always a chance of failure due to unexpected factors. Therefore, please take into account the derating characteristics and allow for sufficient safety features, such as extra margin, anti-flammability, and fail-safe measures when designing in order to prevent possible accidents that may result in bodily harm or fire caused by component failure. ROHM cannot be held responsible for any damages arising from the use of the products under conditions out of the range of the specifications or due to non-compliance with the NOTES specified in this catalog.

Thank you for your accessing to ROHM product informations.

More detail product informations and catalogs are available, please contact your nearest sales office.

**ROHM** Customer Support System

THE AMERICAS / EUROPE / ASIA / JAPAN

[www.rohm.com](http://www.rohm.com)

Contact us : [webmaster@rohm.co.jp](mailto:webmaster@rohm.co.jp)