

# MINIATURE RELAY

## 2 POLES—1 to 2 A (FOR SIGNAL SWITCHING)

### RY SERIES

RoHS Compliant

#### ■ FEATURES

- Ultra high sensitivity
- UL, CSA recognized
- Conforms to FCC rules and regulations Part 68  
—Surge strength 1,500 V
- High dielectric strength type available (RY-WF type)
- Contact arrangement MBB type available (RY-D type)
- High reliability-bifurcated contacts
- Wide operating range
- DIL pitch terminals
- Plastic sealed type
- RoHS compliant since date code: 0438B9  
Please see page 8 for more information

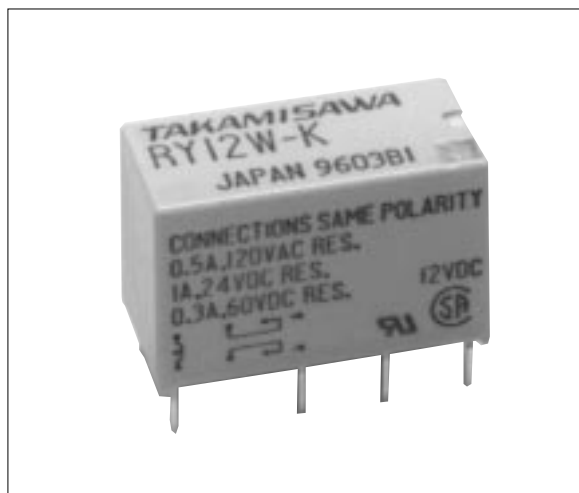

#### ■ ORDERING INFORMATION

[Example]       $\frac{RY}{(a)}$  -  $\frac{12}{(*)}$   $\frac{WF}{(b)}$  -  $\frac{K}{(d)}$

(a)	Series Name	RY : RY Series
(b)	Nominal Voltage	Refer to the COIL DATA CHART
(c)	Coil and Contact Function	W : High sensitive type WZ : Nominal 0.5 W type WF : High dielectric strength type WFZ : 2 A type D : 2 FORM D (2 MBB type)
(d)	Enclosure	K : Plastic sealed type

Note: Actual marking omits the hyphen (-) of (\*)  
For movable and stationary contact with gold overlay type, add suffix “-OH”.

## ■ SAFETY STANDARD AND FILE NUMBERS

UL478, 508 (File No. E45026)

C22.2 No. 14 (File No. LR35579)

Please request when the approval markings are required on the cover.

Please note that UL/CSA ratings may differ from the standard ratings.

Type	Nominal voltage	Contact rating* <sup>1</sup>	
RY-W RY-WZ	3 to 48 VDC	0.5 A 120 VAC 1 A 24 VDC 0.3 A 60 VDC	resistive
RY-WF	5 to 48 VDC	0.25 A 120 VAC 1 A 48 VDC 0.3 A 60 VDC	resistive
RY-WFZ	3 to 48 VDC	0.5 A 120 VAC 2 A 30 VDC 0.6 A 110 VDC	resistive
RY-D	4.5 to 48 VDC	0.3 A 120 VAC 0.2 A 60 VDC	resistive

Note: \*<sup>1</sup> Contact ratings mentioned above are subject to same polarity.

# RY SERIES

## ■ SPECIFICATIONS

Item		High Sensitive Type	500 mW Type	High Dielectric Strength	2 A Type	Continuous (MBB) Type	
		RY-( ) W-K	RY-( ) WZ-K	RY-( ) WF-K	RY-( ) WFZ-K	RY-( ) D-K	
Contact	Arrangement	2 form C (DPDT)				2 Form D (2 MBB)	
	Material	Gold overlay silver-palladium			Gold overlay silver-nickel	Gold overlay silver-palladium	
	Style	Bifurcated				Single	
	Resistance (initial)	Maximum 100 mΩ (at 1 A 6 VDC)					
	Maximum Carrying Current	1.25 A			2 A	0.6 A	
	Rating	1 A 24 VD 0.5 A 120 VAC		1 A 24 VDC 0.25 A 120 VAC	2 A 30 VDC 0.5 A 125 VAC	0.15 A 48 VDC 0.3 A 120 VAC	
	Maximum Switching Power	60 VA/24 W		30 VA/24 W	62.5 VA/60 W	36 VA/7.2 W	
	Maximum Switching Voltage	120 VAC, 60 VDC			125 VAC, 150 VDC	120 VAC, 60 VDC	
	Maximum Switching Current	1 A			2 A	0.6 A	
	Minimum Switching Load*1	0.01 mA 10 mVDC				0.1 mA 10 mVDC	
	Capacitance	Approx. 0.9 pF (between open contacts) 1.4 pF (adjacent contacts) Approx. 1.9 pF (between coil and contacts)					
Coil	Nominal Power (at 20°C)	0.15 to 0.30 W	0.5 to 0.58 W	0.45 to 0.46 W	0.5 to 0.58W	0.45 to 0.48 W	
	Operate Power (at 20°C)	0.075 to 0.14 W	0.125 to 0.145 W	0.2 to 0.21 W	0.2 to 0.324 W	0.2 to 0.21 W	
	Operating Temperature (No frost)	-30°C to +90°C	-30°C to +60°C (refer to the CHARACTERISTIC DATA)			-30°C to +70°C	
Time Value	Operate (at nominal voltage)	Maximum 6 ms					
	Release (at nominal voltage)	Maximum 3 ms					
Insulation	Resistance (at 500 VDC)	Minimum 1,000 MΩ					
	Dielectric Strength	between open contacts	AC 500 V 1 minute	1,000 VAC 1 minute	500 VAC 1 minute		
		between adjacent contacts	1,000 VAC 1 minute				
		between coil and contacts	1,000 VAC 1 minute				
Surge Strength	1,500 V						
Life	Mechanical	2 × 10 <sup>7</sup> ops. min.	1 × 10 <sup>7</sup> operations minimum			1 × 10 <sup>6</sup> ops. min.	
	Electrical (at contact rating)	2 × 10 <sup>5</sup> ops. min. (0.5 A 120 VAC) 5 × 10 <sup>5</sup> ops. min. ( 1 A 24 VD C)	5 × 10 <sup>5</sup> ops. min. (0.25 A 120 VAC 1 A 24 VDC	1 × 10 <sup>5</sup> ops. min. (2 A 30 VDC)		2 × 10 <sup>5</sup> ops. min. (0.3 A 120 VAC) 5 × 10 <sup>5</sup> ops. min. (0.15 A 48 VDC)	
Other	Vibration	Misoperation	10 to 55 Hz (double amplitude of 1.5 mm)				
		Endurance	10 to 55 Hz (double amplitude of 4.5 mm)				
	Shock	Misoperation	100 m/s <sup>2</sup> (11±1 ms)				
		Endurance	1,000 m/s <sup>2</sup> ( 6±1 ms)				
	Weight	Approximately 5 g					

\*1 Minimum switching loads mentioned above are reference values. Please perform the confirmation test with the actual load before production since reference values may vary according to switching frequencies, environmental conditions and expected reliability levels.

# RY SERIES

## ■ COIL DATA CHART

	MODEL	Nominal voltage	Coil resistance (±10%)	Must operate voltage	Must release voltage	Nominal power
High Sensitive Type	RY-4.5 W-K	4.5 VDC	135Ω	3.2 VDC	0.23 VDC	150 mW
	RY- 5 W-K	5 VDC	165Ω	3.6 VDC	0.25 VDC	150 mW
	RY- 6 W-K	6 VDC	240Ω	4.3 VDC	0.3 VDC	150 mW
	RY- 9 W-K	9 VDC	540Ω	6.4 VDC	0.45 VDC	150 mW
	RY- 12 W-K	12 VDC	960Ω	8.5 VDC	0.6 VDC	150 mW
	RY- 18 W-K	18 VDC	1,620Ω	12.6 VDC	0.9 VDC	200 mW
	RY- 24 W-K	24 VDC	2,880Ω	16.8 VDC	1.2 VDC	200 mW
	RY- 48 W-K	48 VDC	7,680Ω	32.6 VDC	2.4 VDC	300 mW
500 mW Type	RY- 3 WZ-K	3 VDC	18Ω	1.5 VDC	0.15 VDC	500 mW
	RY-4.5 WZ-K	4.5 VDC	36Ω	2.25 VDC	0.23 VDC	560 mW
	RY- 5 WZ-K	5 VDC	45Ω	2.5 VDC	0.25 VDC	560 mW
	RY- 6 WZ-K	6 VDC	66Ω	3.0 VDC	0.3 VDC	550 mW
	RY- 9 WZ-K	9 VDC	140Ω	4.5 VDC	0.45 VDC	580 mW
	RY- 12 WZ-K	12 VDC	280Ω	6.0 VDC	0.6 VDC	510 mW
	RY- 18 WZ-K	18 VDC	560Ω	9.0 VDC	0.9 VDC	580 mW
	RY- 24 WZ-K	24 VDC	1,070Ω	12.0 VDC	1.2 VDC	540 mW
RY- 48 WZ-K	48 VDC	4,000Ω	24.0 VDC	2.4 VDC	580 mW	
High Dielectric Strength	RY- 5 WF-K	5 VDC	56Ω	3.3 VDC	0.25 VDC	450 mW
	RY- 6 WF-K	6 VDC	80Ω	4.0 VDC	0.3 VDC	450 mW
	RY- 9 WF-K	9 VDC	180Ω	6.0 VDC	0.45 VDC	450 mW
	RY- 12 WF-K	12 VDC	320Ω	8.0 VDC	0.6 VDC	450 mW
	RY- 18 WF-K	18 VDC	720Ω	12.0 VDC	0.9 VDC	450 mW
	RY- 24 WF-K	24 VDC	1,260Ω	15.9 VDC	1.2 VDC	450 mW
	RY- 48 WF-K	48 VDC	5,000Ω	33.0 VDC	2.4 VDC	460 mW
2 A Type	RY- 3 WFZ-K	3 VDC	18Ω	1.9 VDC	0.15 VDC	500 mW
	RY-4.5 WFZ-K	4.5 VDC	36Ω	2.9 VDC	0.23 VDC	560 mW
	RY- 5 WFZ-K	5 VDC	45Ω	3.2 VDC	0.25 VDC	560 mW
	RY- 6 WFZ-K	6 VDC	66Ω	3.8 VDC	0.3 VDC	550 mW
	RY- 9 WFZ-K	9 VDC	140Ω	5.7 VDC	0.45 VDC	580 mW
	RY- 12 WFZ-K	12 VDC	280Ω	7.6 VDC	0.6 VDC	510 mW
	RY- 18 WFZ-K	18 VDC	560Ω	11.4 VDC	0.9 VDC	580 mW
	RY- 24 WFZ-K	24 VDC	1,070Ω	15.2 VDC	1.2 VDC	540 mW
	RY -48 WFZ-K	48 VDC	4,000Ω	36.0 VDC	2.4 VDC	580 mW

Note : All values in the table are measured at 20°C.

# RY SERIES

MODEL		Nominal voltage	Coil resistance ( $\pm 10\%$ )	Must operate voltage	Must release voltage	Nominal power
Continuous (MBB) Type	RY-4.5 D-K	4.5 VDC	45 $\Omega$	3.0 VDC	0.23 VDC	450 mW
	RY- 5 D-K	5 VDC	55 $\Omega$	3.3 VDC	0.25 VDC	450 mW
	RY- 6 D-K	6 VDC	80 $\Omega$	3.95 VDC	0.3 VDC	450 mW
	RY- 9 D-K	9 VDC	180 $\Omega$	5.9 VDC	0.45 VDC	450 mW
	RY- 12 D-K	12 VDC	320 $\Omega$	7.9 VDC	0.6 VDC	450 mW
	RY- 18 D-K	18 VDC	720 $\Omega$	11.8 VDC	0.9 VDC	450 mW
	RY- 24 D-K	24 VDC	1,280 $\Omega$	15.8 VDC	1.2 VDC	450 mW
	RY- 48 D-K	48 VDC	4,800 $\Omega$	31.8 VDC	2.4 VDC	480 mW

Note : All values in the table are measured at 20°C.

## CHARACTERISTIC DATA

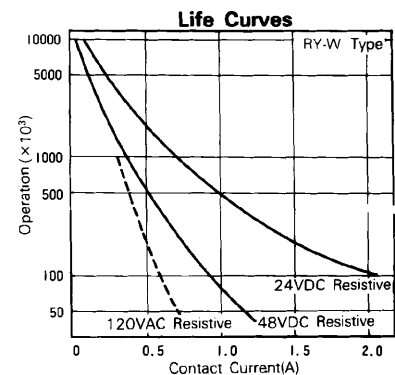
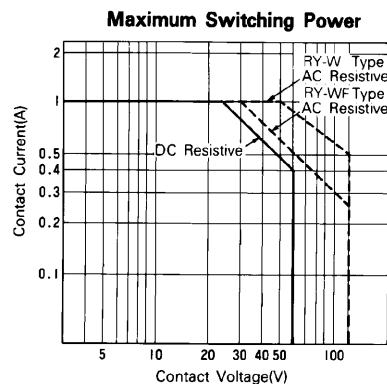
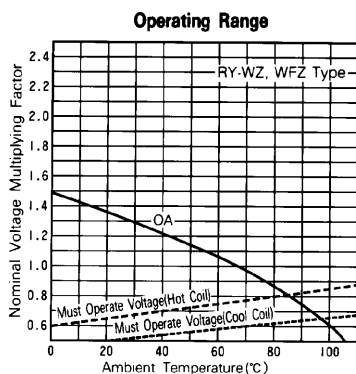
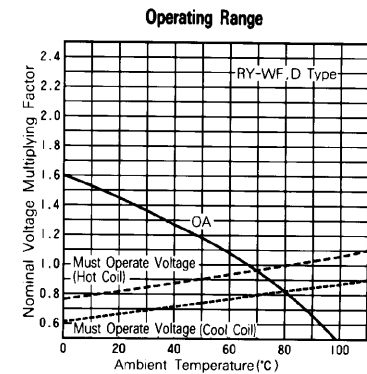
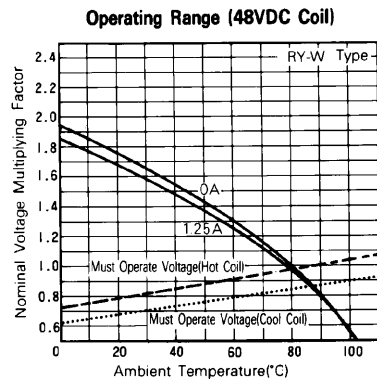
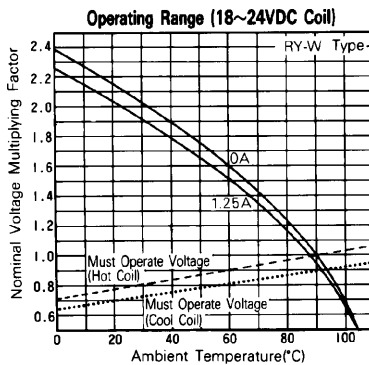
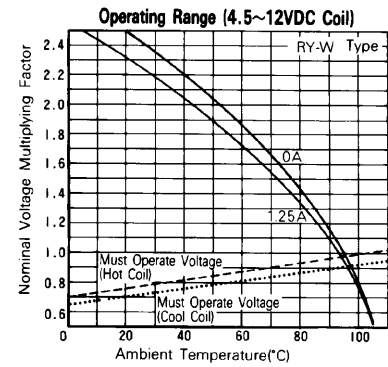
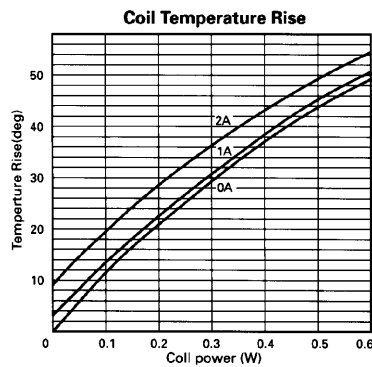
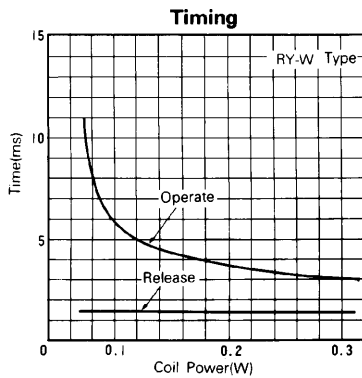

## REFERENCE DATA

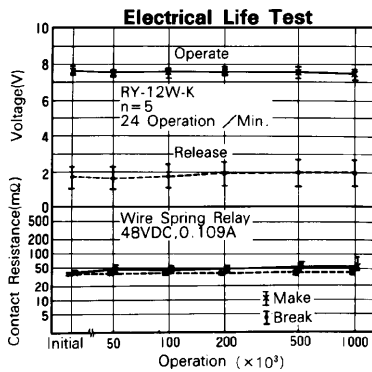
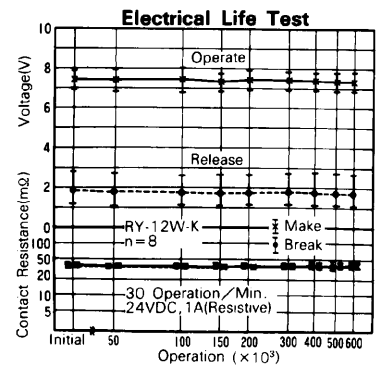
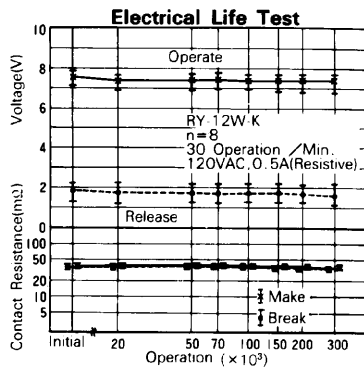
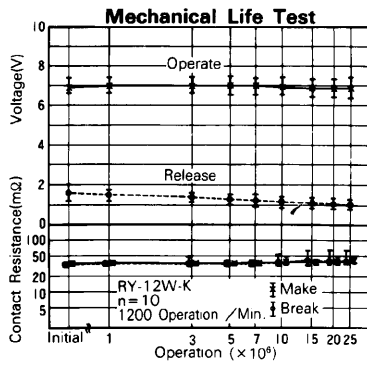
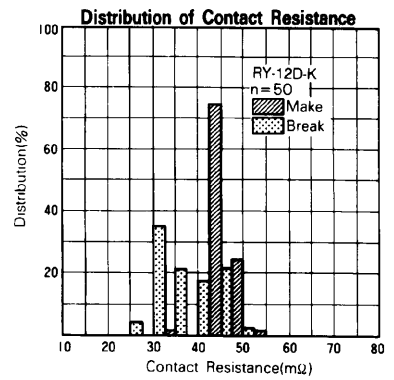
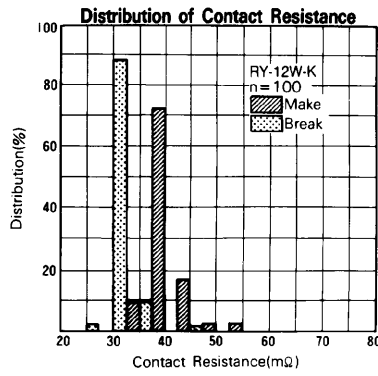
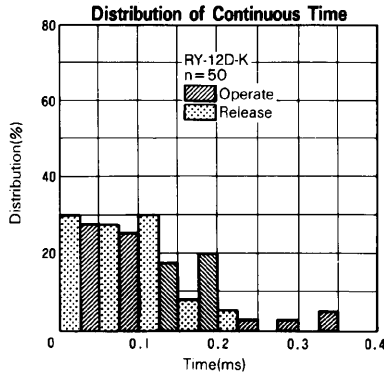
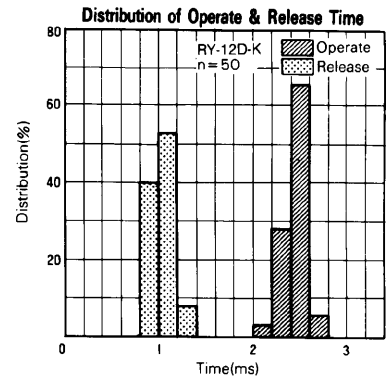
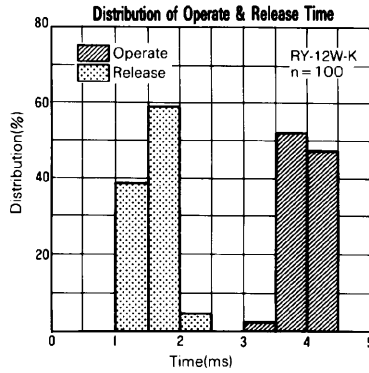
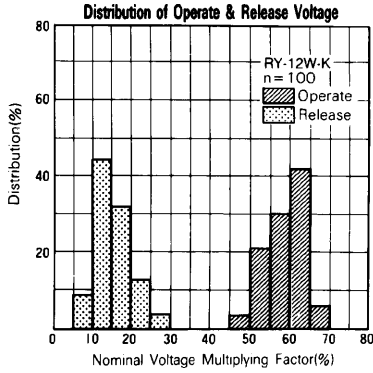

## ■ DIMENSIONS

### ● Dimensions

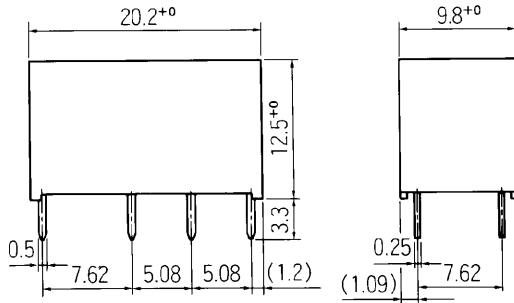

### ● Schematics (Bottom view)

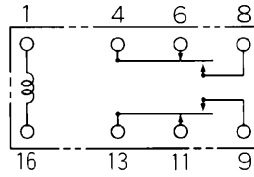

### ● PC board mounting hole layout (Bottom view)

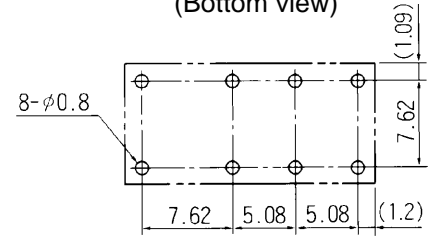

Unit: mm

## RoHS Compliance and Lead Free Relay Information

### 1. General Information

- Relays produced after the specific date code that is indicated on each data sheet are lead-free now. Most of our signal and power relays are lead-free. Please refer to Lead-Free Status Info. (<http://www.fcai.fujitsu.com/pdf/LeadFreeLetter.pdf>)
- Lead free solder paste currently used in relays is Sn-3.0Ag-0.5Cu. From February 2005 forward Sn-3.0Cu-Ni will be used for FTRB3 and FTR-B4 series relays.
- Most signal and some power relays also comply with RoHS. Please refer to individual data sheets. Relays that are RoHS compliant do not contain the 6 hazardous materials that are restricted by RoHS directive (lead, mercury, cadmium, chromium IV, PBB, PBDE).
- It has been verified that using lead-free relays in lead assembly process will not cause any problems (compatible).
- "LF" is marked on each outer and inner carton. (No marking on individual relays).
- To avoid leaded relays (for lead-free sample, etc.) please consult with area sales office. We will ship leaded relays as long as the leaded relay inventory exists.

### 2. Recommended Lead Free Solder Profile

- Recommended solder paste Sn-3.0Ag-0.5Cu and Sn-3.0 Cu-Ni (only FTR-B3 and FTR-B4 from February 2005)

#### Reflow Solder condition

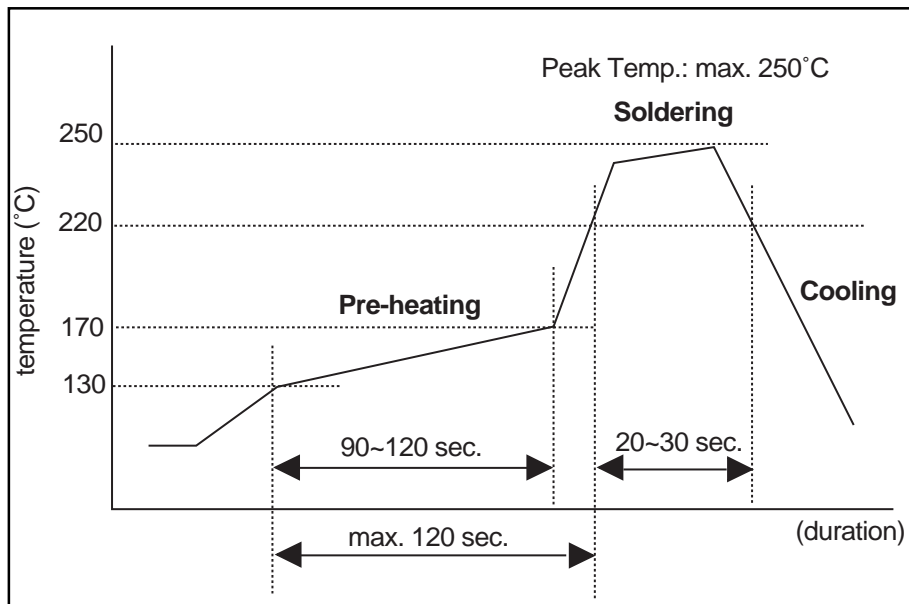

#### Flow Solder condition:

Pre-heating: maximum 120°C  
Soldering: dip within 5 sec. at 260°C solder bath

#### Solder by Soldering Iron:

Soldering Iron  
Temperature: maximum 360°C  
Duration: maximum 3 sec.

**We highly recommend that you confirm your actual solder conditions**

### 3. Moisture Sensitivity

- Moisture Sensitivity Level standard is not applicable to electromechanical relays.

### 4. Tin Whisker

- SnAgCu solder is known as low risk of tin whisker. No considerable length whisker was found by our in-house test.

### 5. Solid State Relays

- Each lead terminal will be changed from solder plating to Sn plating and Nickel plating. A layer of Nickel plating is between the terminal and the Sn plating to avoid whisker.



## **Fujitsu Components International Headquarter Offices**

### **Japan**

Fujitsu Component Limited  
Gotanda-Chuo Building  
3-5, Higashigotanda 2-chome, Shinagawa-ku  
Tokyo 141, Japan  
Tel: (81-3) 5449-7010  
Fax: (81-3) 5449-2626  
Email: [promothq@ft.ed.fujitsu.com](mailto:promothq@ft.ed.fujitsu.com)  
Web: [www.fcl.fujitsu.com](http://www.fcl.fujitsu.com)

### **North and South America**

Fujitsu Components America, Inc.  
250 E. Caribbean Drive  
Sunnyvale, CA 94089 U.S.A.  
Tel: (1-408) 745-4900  
Fax: (1-408) 745-4970  
Email: [marcom@fcai.fujitsu.com](mailto:marcom@fcai.fujitsu.com)  
Web: [www.fcai.fujitsu.com](http://www.fcai.fujitsu.com)

### **Europe**

Fujitsu Components Europe B.V.  
Diamantlaan 25  
2132 WV Hoofddorp  
Netherlands  
Tel: (31-23) 5560910  
Fax: (31-23) 5560950  
Email: [info@fceu.fujitsu.com](mailto:info@fceu.fujitsu.com)  
Web: [www.fceu.fujitsu.com](http://www.fceu.fujitsu.com)

### **Asia Pacific**

Fujitsu Components Asia Ltd.  
102E Pasir Panjang Road  
#04-01 Citilink Warehouse Complex  
Singapore 118529  
Tel: (65) 6375-8560  
Fax: (65) 6273-3021  
Email: [fcal@fcal.fujitsu.com](mailto:fcal@fcal.fujitsu.com)  
[www.fcal.fujitsu.com](http://www.fcal.fujitsu.com)

© 2004 Fujitsu Components America, Inc. All company and product names are trademarks or registered trademarks of their respective owners. Rev. 12/07/2004.