

DATA BOOK

Thin Film Components

Thin Film Chip Resistors

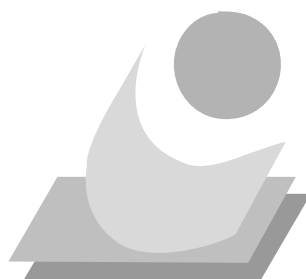

Thin Film Power

SUSUMU CO., LTD.

Thin Film Chip Resistors

Structure

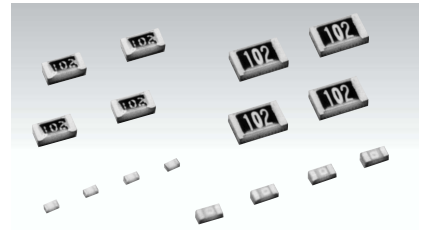
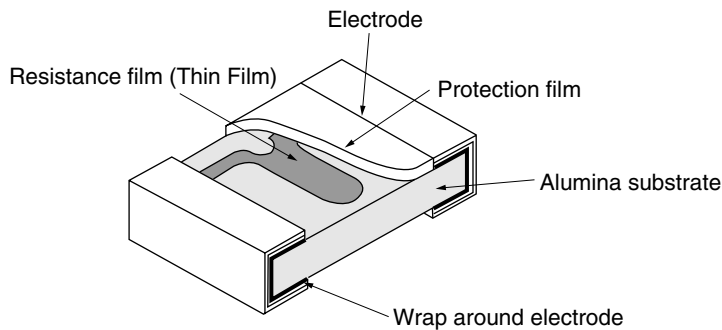

Features

- Excellent TCR
- Excellent current noise characteristics
- Excellent third harmonic distortion characteristics
- Tight resistance tolerance and high stability

Specifications

<Dimensions>

Dimension (mm)	RR0306 (0201)	RR0510 (0402)	RR0816 (0603)	RR1220 (0805)	RR1632 (1206)	RR2632 (1210)	
L	0.60±0.05	1.00±0.05	1.60±0.20	2.00±0.20	3.20±0.20	3.20±0.20	
W	0.30±0.05	0.50±0.05	0.80±0.20	1.25±0.20	1.60±0.20	2.60±0.20	
P	0.12±0.05	0.20±0.10	0.30±0.20	0.40±0.20	0.50±0.30	0.50±0.20	
T	0.23±0.03	0.35±0.05	0.40±0.10	0.40±0.10	0.40±0.10	0.45±0.10	

<Electric characteristics>

Type	RR0306 (0201)		RR0510 (0402)		RR0816 (0603)		RR1220 (0805)		RR1632 (1206)		RR2632 (1210)	
Power	1/20W		1/16W		1/16W		1/10W		1/8W		1/4W	
Resistance Tolerance (code)	±1.0% (F)	±0.5% (D)	±0.5% (D)									
Reference Range (ohm)	10~30	33~22K	10~97.6	100~100K	10~97.6	100~360K	10~97.6	100~1M	51~1M	10~1M	51~2M	10~2M
Temperature Coefficient of Resistance ppm/°C	±100 (R)	±25 (P)	±100 (R)	±25 (P)	±50 (Q)	±25 (P)	±50 (Q)	±25 (P)	±25 (P)	±50 (Q)	±25 (P)	±50 (Q)
Resistance Values	E-24		E-24/E-96		E-24/E-96		E-24/E-96		E-24/E-96		E-24/E-96	
Maximum Operating Voltage	15V		25V		75V		100V		150V		200V	

◆ Precision type

Type	RR0816 (0603)	RN73		RR1220 (0805)	RR1632 (1206)		RR2632 (1210)		
Power	1/16W	1/10W			1/8W		1/4W		
Resistance Tolerance (code)	±0.1% (B)	±0.1% (B)	±0.5% (D)	±0.1% (B)					
Reference Range (ohm)	100~332K	100~33K	100~100K	100~1M	100~200K	100~200K	51~1M	100~330K	51~2M
Temperature Coefficient of Resistance ppm/°C	±25 (P)	±5 (V)	±10 (N)	±25 (P)	±5 (V)	±10 (N)	±25 (P)	±10 (N)	±25 (P)
Resistance Values	E-24/E-96	E-24/E-96		E-24/E-96			E-24/E-96		
Maximum Operating Voltage	75V	100V		150V			200V		

Application

Excellent characteristics of thin film performances for broad applications

●Temperature coefficient of resistance

On a high density board, the rising temperature of peripheral parts would change resistance value. As shown in this schematic view of the op-amp of HDD motor control circuit, the amplification is decided by the ratio of R1/R2, which is affected by the heat of the coil of HDD motor. The tight TCR for R1 and R2 are needed.

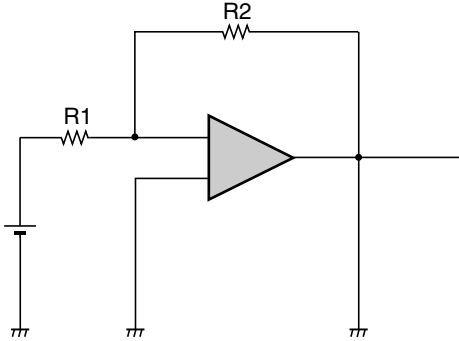

●Current noise and third harmonic distortion characteristics

- (1) In an analog circuit, this series can offer advantages in signal-to-noise ratio and dynamic range in the amplification of low level signals. Especially, the use of this series in the first stage amplification is most effective.
- (2) The use of this series in a digital circuit, the matching could be obtained easily due to low reflection in high frequency band.

●Tight resistance tolerance

- (1) In the above amplifier of an analog circuit, the accuracy of amplification rate could be effectively improved.
- (2) Lower voltage is required in lower power consumption for high frequency digital signals. In order to obtain low distortion of signal wave form, the accuracy of terminators is required.

DATA

<Electric characteristics>

●Resistance distribution

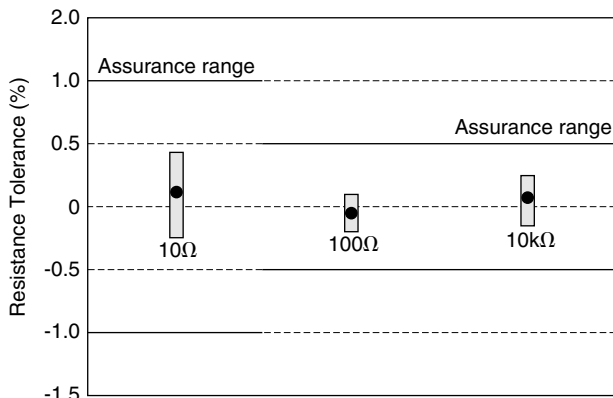

RR0306

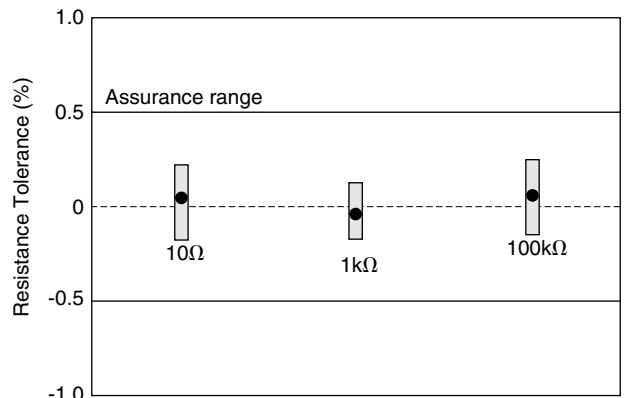

RR0510

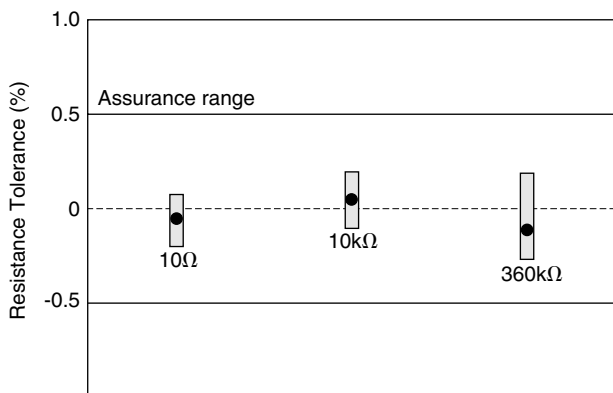

RR0816

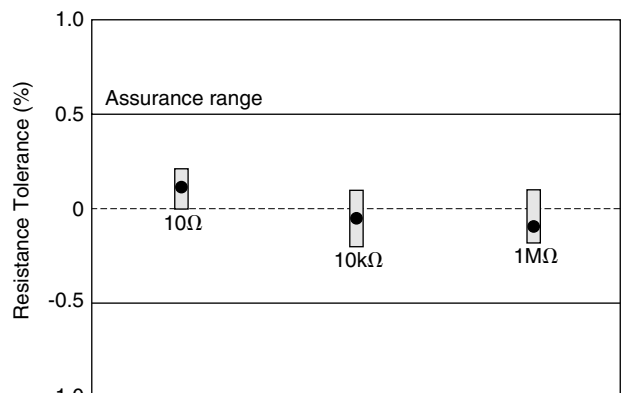

RR1220

● Precision chip resistor Resistance distribution

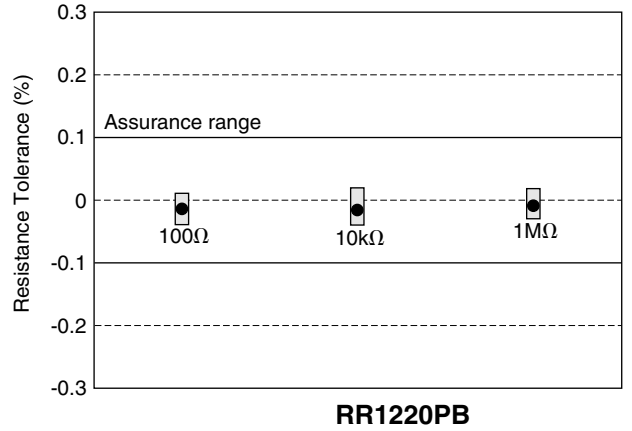
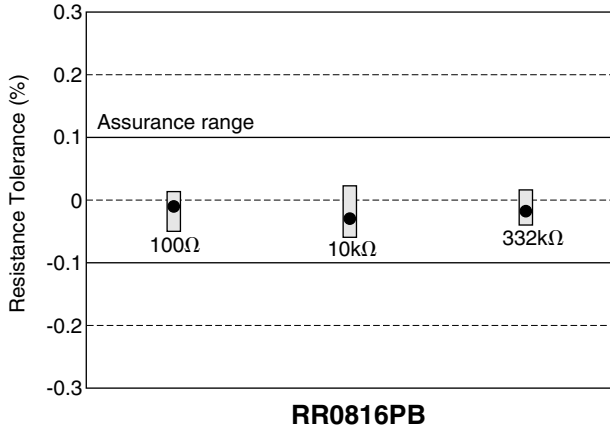

● Temperature Coefficient of Resistance distribution

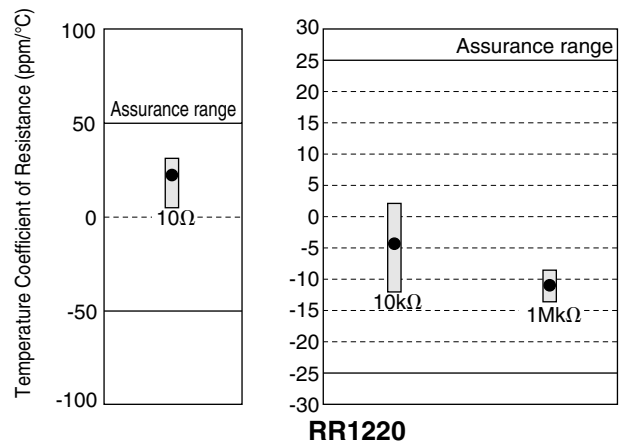
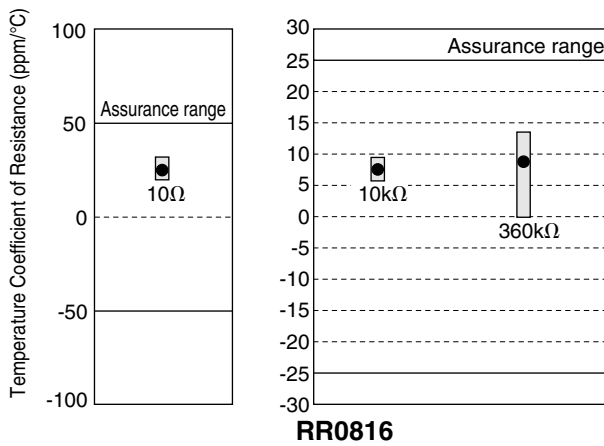
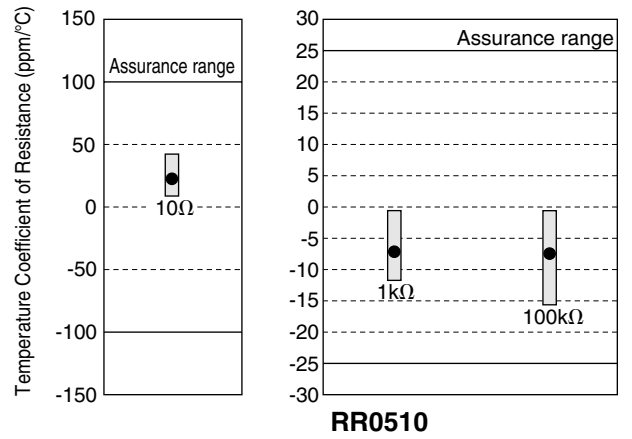
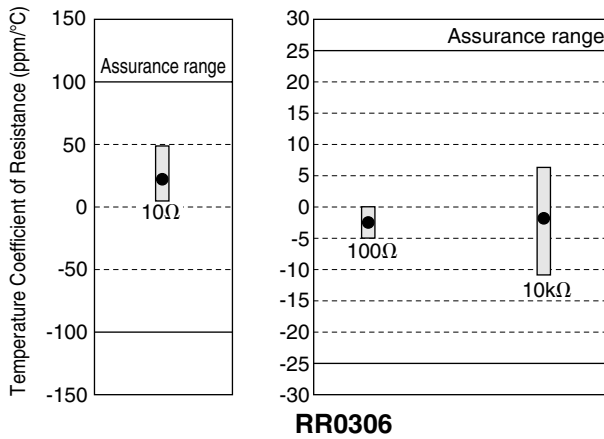

● Precision chip resistor Temperature Coefficient of Resistance distribution

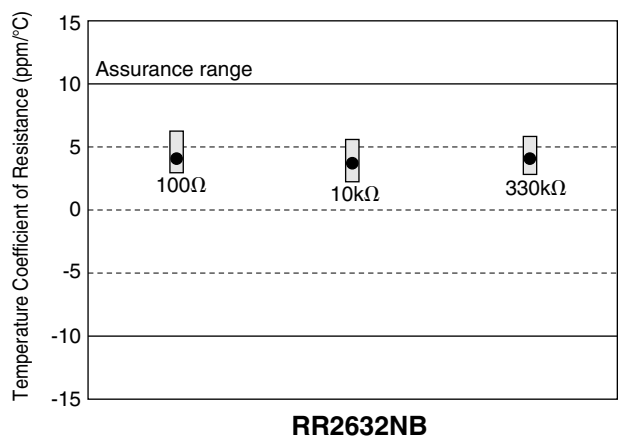
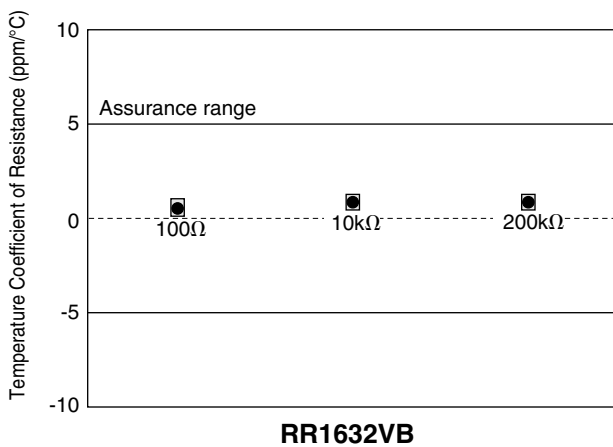

● Current Noise Characteristics

Current noise of resistors was measured in accordance with Annex 1 of JISC5202.

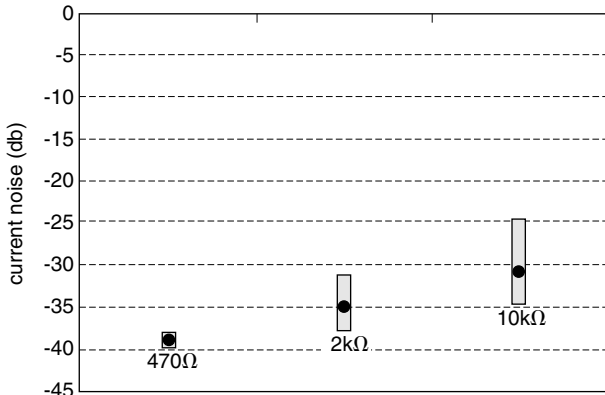

RR0306PD

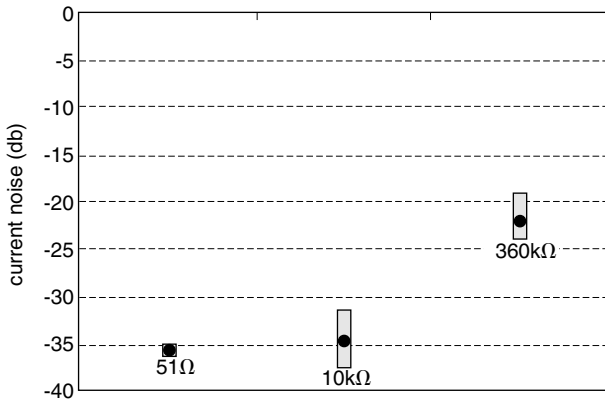

RR0816PD

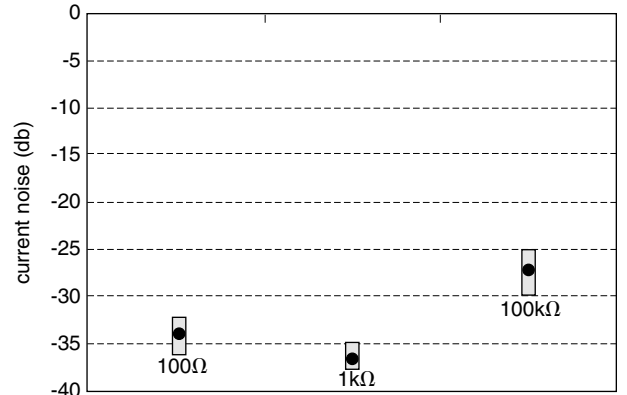

RR0510PD

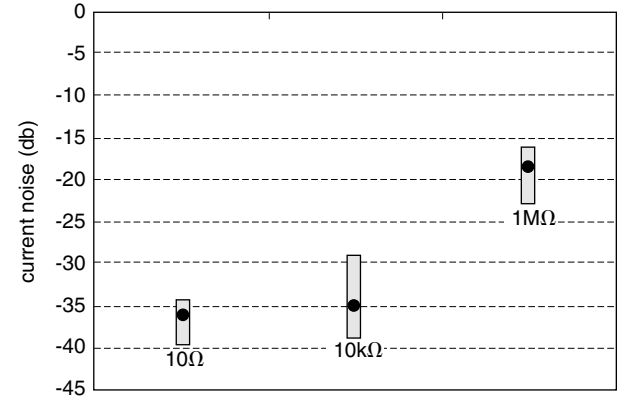

RR1220PD

● The third harmonic distortion Characteristics

Thermal electromotive force generate high harmonic waves, if a sine wave current is applied on the two terminals of a resistor. These high harmonic waves are disproportionate to the sine current wave. Only third harmonic wave is filtered out and its distortion measured. Thin film resistors are excellent at matching impedance in high-frequency circuits because of their small electromotive force and third harmonic component.

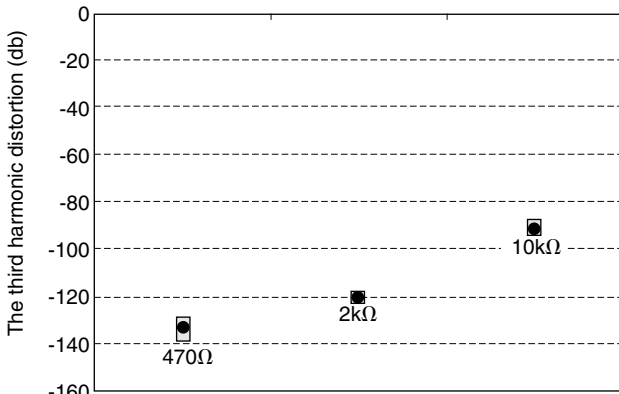

RR0306PD

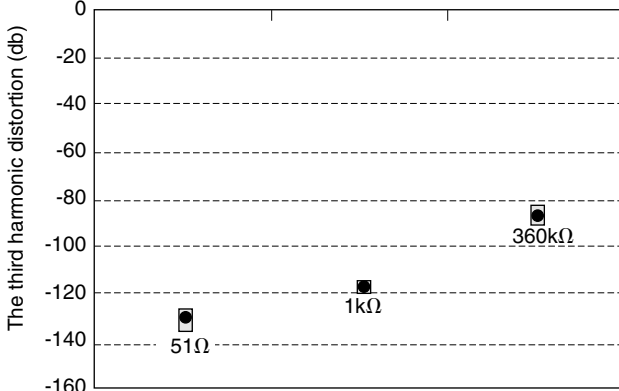

RR0816PD

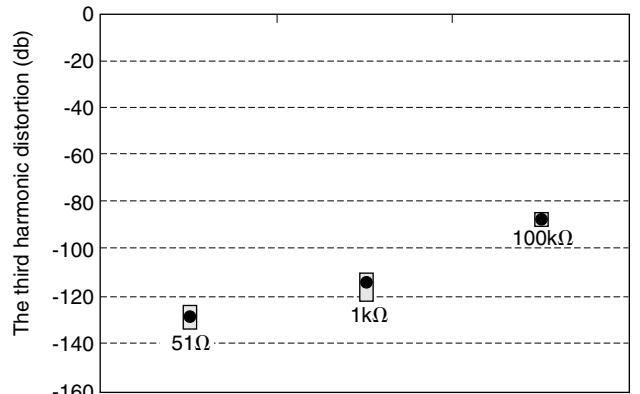

RR0510PD

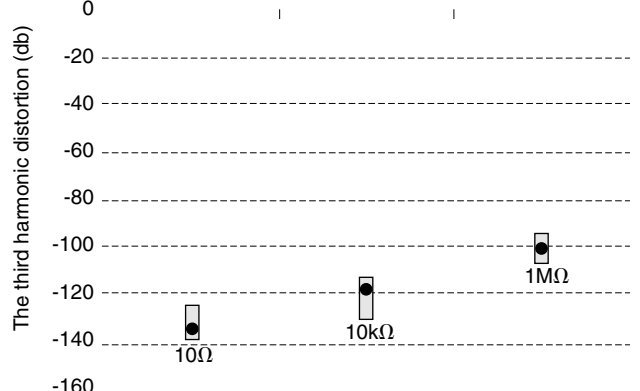

RR1220PD

<High frequency characteristics>

The characteristics shown below is the ratio of effective high frequency resistances over DC Resistances as defined in JISC5202.

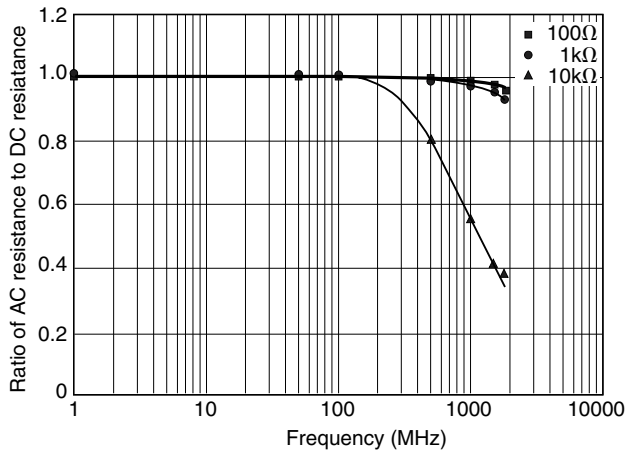

RR0306

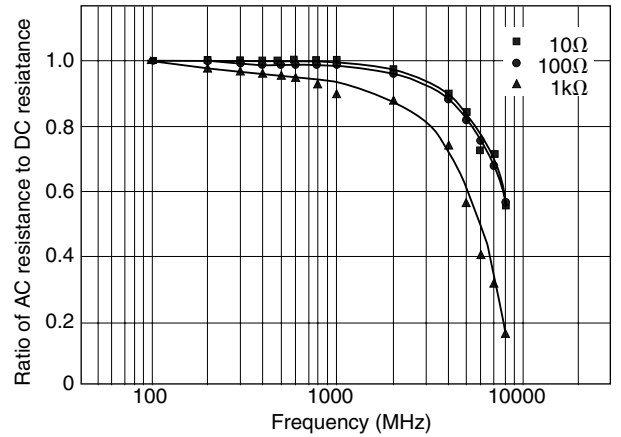

RR0510

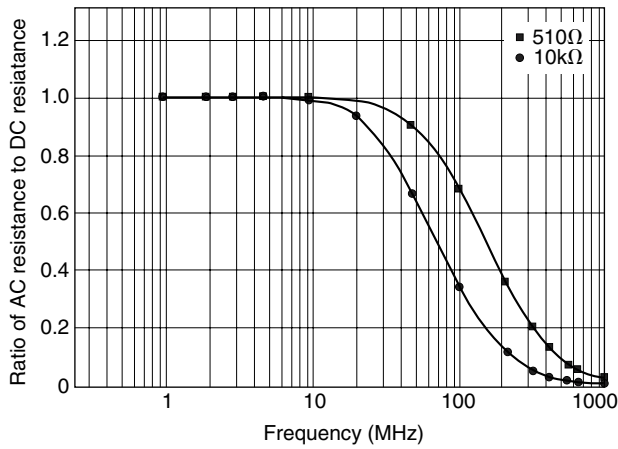

RR0816

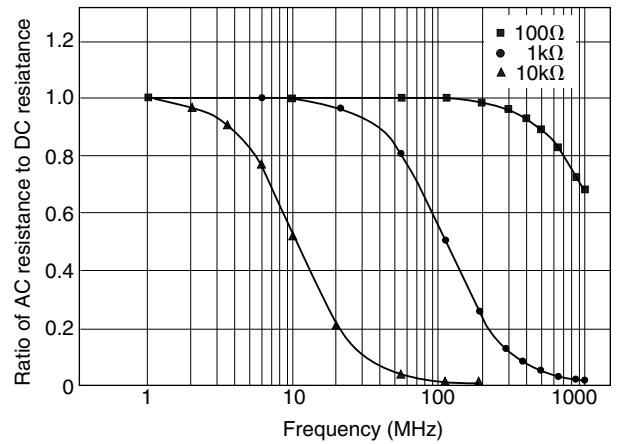

RR1220

Reliability Test DATA

● Load Life Test

Test conditions : 70°C Apply rated voltage for 90 minutes followed by 30 minute intermission. This cycle is repeated for 1,000 hours.

RR0306

Sample:RR0306P-101-D (n = 10pcs)

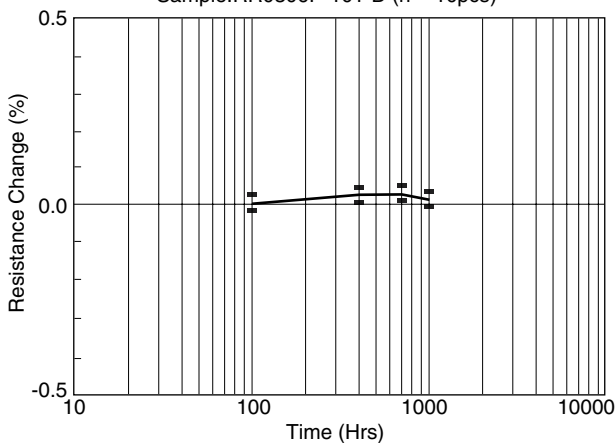

RR0510

Sample:RR0510R-101-D (n = 10pcs)

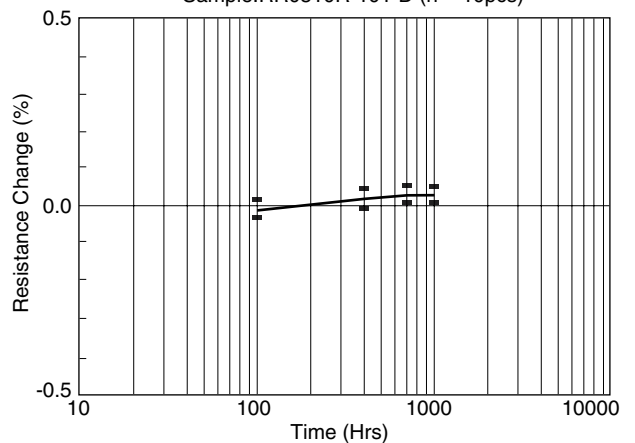

RR0816

Sample:RR0816P-101-D (n = 10pcs)

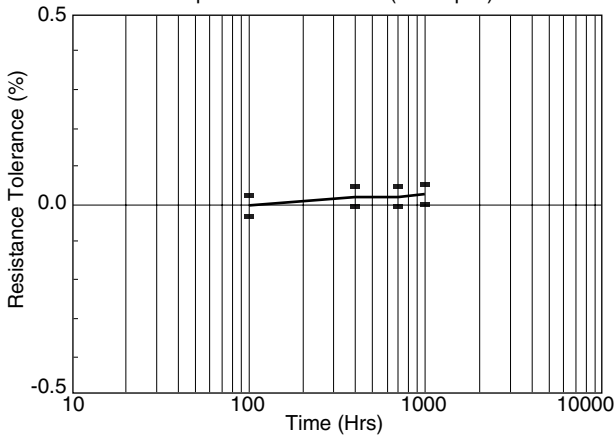

RR1220

Sample:RR1220-101-D (n = 10pcs)

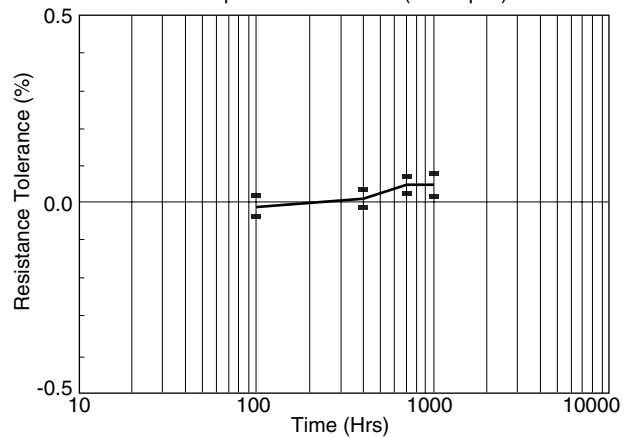

Moisture Load Life Test

Test conditions : 40°C, 95%RH Apply rated voltage for 90 minutes followed by 30 minute intermission. This cycle is repeated for 1,000 hours.

RR0306

Sample:RR0306P-101-D (n = 10pcs)

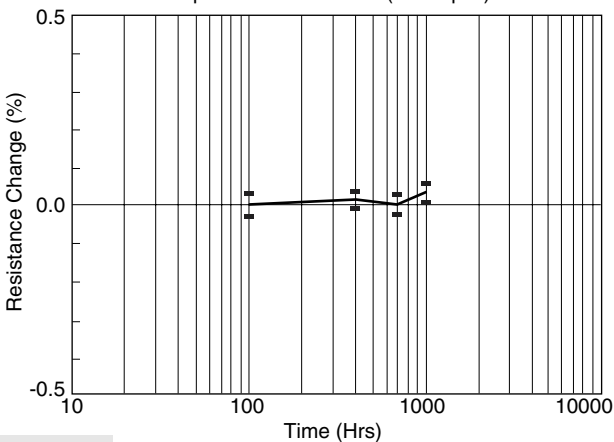

RR0510

Sample:RT0510R-101-D (n = 10pcs)

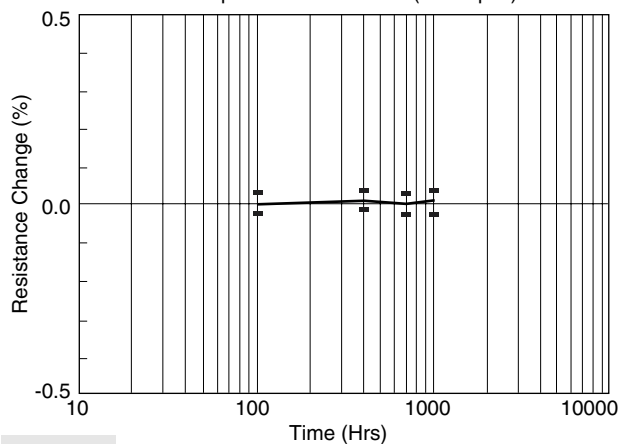

RR0816

Sample:RR0816P-101-D (n = 10pcs)

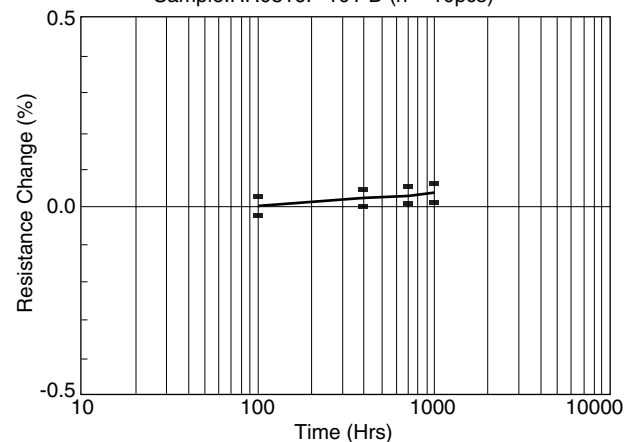

RR1220

Sample:RR1220-101-D (n = 10pcs)

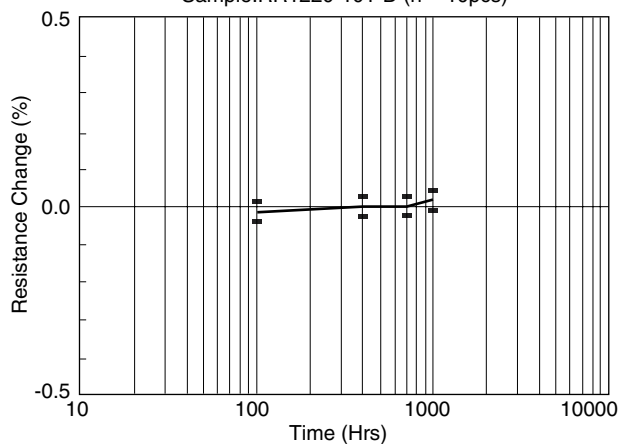

Recommended land patterns

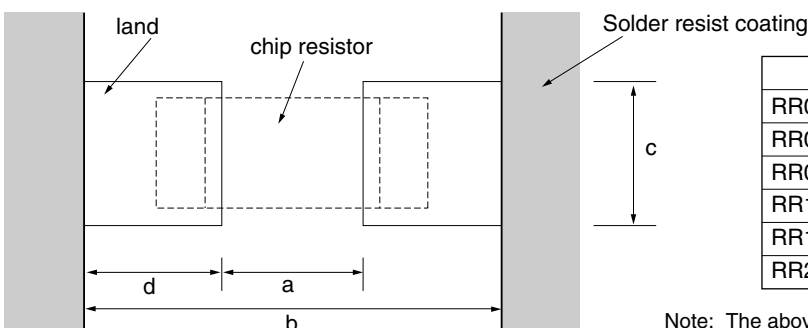

	a	b	c	d
RR0306	0.26~0.30	0.72~0.84	0.32~0.36	0.23~0.27
RR0510	0.5~0.6	1.5~1.8	0.5~0.6	0.5~0.6
RR0816	0.7~0.9	2.4~2.8	0.6~1.0	0.9~1.1
RR1220	1.0~1.4	3.2~3.8	0.9~1.6	0.9~1.4
RR1632	2.0~2.4	4.4~5.0	1.3~2.2	1.0~1.5
RR2632	2.0~2.4	4.4~5.0	2.3~3.2	1.0~1.5

dimension : mm

Note: The above figures are recommended for reflow-soldering or flow-soldering.