

Features

ICE Technology*

- Up to 96°C ambient, no derating
- 120°C Maximum Case Temperature
- -45°C Minimum Temp. (optional: -55°C)
- Built-in FCC/EN55022 Class B Filter
- 2:1 Wide Input Voltage Range
- Six Sided Shielded Enclosure
- Ribbed, Flat or Baseplate Case Styles
- Efficiency to 92%
- 3kVDC Isolation
- Fully Protected Outputs
- Low Quiescent Current

Description

The RPP30 series 2:1 input range DC/DC converters are ideal for high end industrial applications and COTS Military applications where a very wide operating temperature range of -45°C to +120°C is required. The converters are also optionally available with a -55°C start-up temperature. Although the case size is compact, the converter contains a built-in filter EN55022 Class B / FCC Level B without the need for any external components. The RPP30 is available in three case styles: the high operating temperature ribbed case, the low profile flat case and the baseplate case for high vibration or bulkhead-mounting applications. They are UL-60950-1 certified.

Selection Guide 12V, 24V and 48V Input Types

Part Number	Input Range VDC	Output Voltage VDC	Output Current mA	Input ⁽¹⁾ Current mA	Efficiency ⁽²⁾	Max ⁽³⁾ Operating Temp
RPP30-123.3S	9-18	3.3	8500	78/2666	87.5%	86°C
RPP30-1205S	9-18	5	6000	109/2768	90.3%	91°C
RPP30-1212S	9-18	12	2500	26/2784	89.8%	89°C
RPP30-1215S	9-18	15	2000	31/2775	90.1%	91°C
RPP30-1224S	9-18	24	1250	31/2775	90.1%	91°C
RPP30-243.3S	18-36	3.3	8000	59/1394	89.7%	89°C
RPP30-2405S	18-36	5	6000	62/1372	91.1%	93°C
RPP30-2412S	18-36	12	2500	18/1400	90.4%	91°C
RPP30-2415S	18-36	15	2000	18/1380	91.4%	94°C
RPP30-2424S	18-36	24	1250	18/1380	91.4%	94°C
RPP30-483.3S	36-75	3.3	8000	24/697	89.6%	89°C
RPP30-4805S	36-75	5	6000	37/680	92.0%	96°C
RPP30-4812S	36-75	12	2500	11/687	91.0%	94°C
RPP30-4815S	36-75	15	2000	12/682	91.6%	94°C
RPP30-4824S	36-75	24	1250	12/682	91.6%	94°C
RPP30-1212D	9-18	±12	±1250	29/2790	89.6%	89°C
RPP30-1215D	9-18	±15	±1000	33/2784	89.8%	89°C
RPP30-1224D	9-18	±24	±625	33/2784	89.8%	89°C
RPP30-2412D	18-36	±12	±1250	20/1300	88.4%	86°C
RPP30-2415D	18-36	±15	±1000	10/1392	89.8%	89°C
RPP30-2424D	18-36	±24	±625	10/1384	90.3%	91°C
RPP30-4812D	36-75	±12	±1250	11/647	88.8%	87°C
RPP30-4815D	36-75	±15	±1000	12/689	90.7%	94°C
RPP30-4824D	36-75	±24	±625	26/622	90.7%	94°C

**SUFFIX INFORMATION

- none = Standard Ribbed Case
- B = Baseplate Case
- F = Flat Case
- L = Low Temp (-55°C) Ribbed Case
- M = Low Temp (-55°C) Baseplate Case
- T = Low Temp (-55°C) Flat Case

add "1" before suffix for neg. CTRL logic
e.g. -1, -1B, -1F, etc.

Derating graphs are valid only for the shown part numbers.
Please contact Technical Support for more information
info@recom-development.at

POWERLINE+

DC/DC-Converter

with 3 year Warranty

30 Watt

2:1 Single & Dual Output

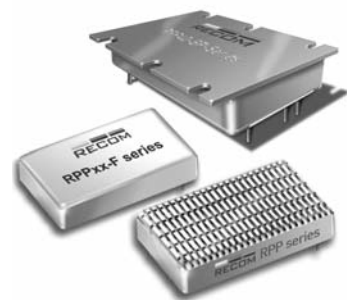

UL-60950-1 Certified
E224736

RPP30

Derating Graph (Ambient Temperature)

RPP30-4805S

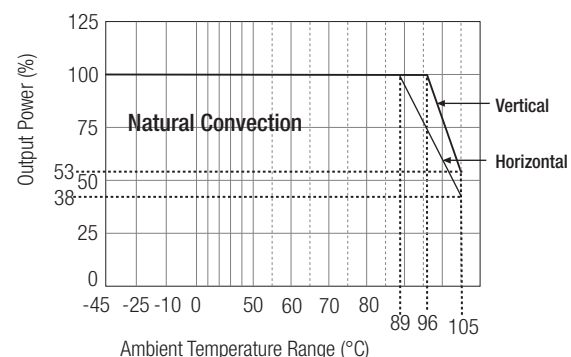

* ICE Technology

ICE (Innovation in Converter Excellence) uses state-of-the-art techniques to minimise internal power dissipation and to increase the internal temperature limits to extend the ambient operating temperature range to the maximum. Refer to Application Notes

Specifications (typical at nominal input and 25°C unless otherwise noted)

Input Voltage Range	12V nominal input	9-18VDC	
	24V nominal input	18-36VDC	
	48V nominal input	36-75VDC	
Under Voltage Lockout	12V input	DC-DC ON (min.)	8.5VDC
		DC-DC OFF (max.)	8VDC
	24V input	DC-DC ON (min.)	17.5VDC
		DC-DC OFF (max.)	17VDC
	48V input	DC-DC ON (min.)	35VDC
		DC-DC OFF (max.)	34VDC
Input Filter		Common Mode EMCType	
Input Voltage Variation dv/dt (Complies with ETS300 132 part 4.4)		5V/ms max	
Input Surge Voltage (100 ms max.)	12V, 24V Input	50VDC	
	48V Input	100VDC	
Input Reflected Ripple	nominal Vin and full load	30mA _{p-p}	
Start Up Time	nominal Vin and constant resistor load	2ms typ., 5ms max.	
Remote ON/OFF ⁽⁴⁾	DC-DC ON	Open or 3.0V < Vr < 5.5V	
Remote OFF input current	DC-DC OFF	Short or 0V < Vr < 1.2V	
	Nominal input	2mA typ.	
Output Power		30W max.	
Output Voltage Accuracy	50% Load and nominal Vin	±1.5%	
Voltage Adjustability	Single Output only	±10%	
Minimum Load		0%	
Line Regulation	low line, high line at full load	±0.3%	
Load Regulation	10% to 100% full load	±0.5%	
Cross Regulation (10% <> 100% Load)	Dual Outputs only	3% typ./ 5% max.	
Ripple and Noise (20MHz bandwidth limited) (measured with 1µF capacitor across outputs)	3.3V, 5V	60mV _{p-p} typ.	
	All others	25mV-45mV _{p-p} max.	
Temperature Coefficient		±0.04%/°C max.	
Transient Response	25% load step change	800µs	
Over Load Protection	% of full load at nominal Vin	120% typ.	
Short Circuit Protection		Hiccup, automatic recovery	
Output Over Voltage Protection (refer to block diagram in Application Notes)		Converter shutdown if Vout > Vout nominal + 20%	
Isolation Voltage		Rated at 2250VDC/1 minute, Flash tested at 3000VDC/1 second	
Isolation Resistance		10MΩ min.	
Isolation Capacitance (refer to block diagram in Application Notes)		3000pF max.	
Operating Frequency		260kHz ± 40kHz	
Operating Temperature Range	Ambient, Free Convection	-45°C to +96°C max (without derating)	
		-45°C to +105°C max (with derating)	
	-55°C Version	-55°C to +96°C (without derating)	
Maximum Case Temperature		+120°C	
Storage Temperature Range		-55°C to +125°C	
Over Temperature Protection (refer to block diagram in Application Notes)		internal thermistor	
Thermal Impedance (Natural convection)	Ribbed Case: Vertical	7.3°C/Watt	
	Ribbed Case: Horizontal	10°C/Watt	
Relative Humidity		5% to 95% RH	
Case Material ⁽⁷⁾		Aluminium	
Potting Material		Silicone (UL94-V0)	

continued on next page

Specifications (typical at nominal input and 25°C unless otherwise noted)

Weight	Ribbed Case	39g
	Flat Case	34g
	Basplate Case	43g
Packing Quantity	Ribbed and Flat Case	4 pcs per Tube
	Baseplate Case	Single Packed
Safety Standards	certified UL-60950-1, 1st Edition	
Thermal Cycling	complies with MIL-STD-810F	
Vibration	10-55Hz, 12G, 30 Min. along X, Y and Z	
Conducted Emissions	EN55022	Class B
Radiated Emissions	EN55022	Class B
ESD	EN61000-4-2	Perf. Criteria B
Radiated Immunity	EN61000-4-3	Perf. Criteria A
Fast Transient ⁽⁶⁾	EN61000-4-4	Perf. Criteria B
Surge ⁽⁶⁾	EN61000-4-5	Perf. Criteria B
Conducted Immunity	EN61000-4-6	Perf. Criteria A
MTBF calculated according to BELLCORE TR-NWT-000332 ⁽⁶⁾	2195 x 10 ³ hours	

Notes :

1. Typical values at nominal input voltage and no load/full load.
2. Typical values at nominal input voltage and full load.
3. Typical values at nominal input voltage and full load in vertical orientation and with Eurocard-sized PCB ground planes to assist in heat dissipation. For horizontal orientation, reduce the maximum temperatures by 10°C.
4. The ON/OFF pin voltage is referenced to negative input. The pin is pulled high internally
ON/OFF control is standard with positive logic: e.g. RPP30-2405S, RPP30-4805D-B
Add "1" before the suffix for negative logic: e.g. RPP30-2405S-1, RPP30-4805D-1B.
Positive logic: 0 = OFF, 1 = ON. The converter will be ON if the CTRL is left open.
Negative logic: 1 = OFF, 0 = ON. The converter will be OFF if the CTRL is left open.
5. Requires an external 100µF low ESR capacitor to meet EN61000-4-4 and EN61000-4-5
6. Case I: 50% Stress, Temperature at 50°C (Ground Benign).
7. To ensure a good all-round electrical contact, the baseplate is pressed firmly into place within the aluminium housing. The hydraulic press can leave tooling marks and deformations to both the housing and baseplate. The case is anodised aluminium, so there will be natural variations in the case colour and the aluminium is not scratch resistant. Any resultant marks, scratches and colour variations are cosmetic only and do not affect the operation or performance of the converters.

External Output Trimming
Refer to Application Notes for suggested resistor values

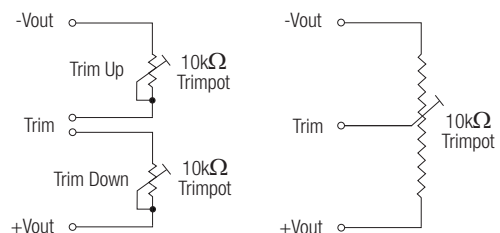

Typical Characteristics

RPP30-4805S

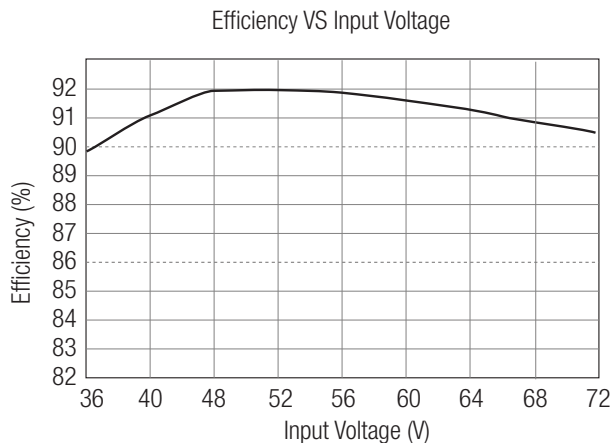
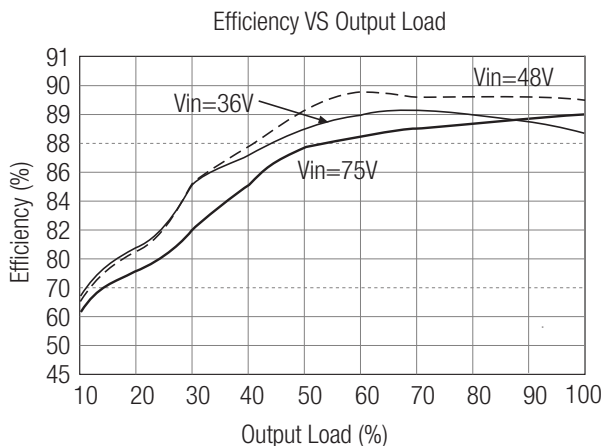

Recommended PCB Layout

Single Output

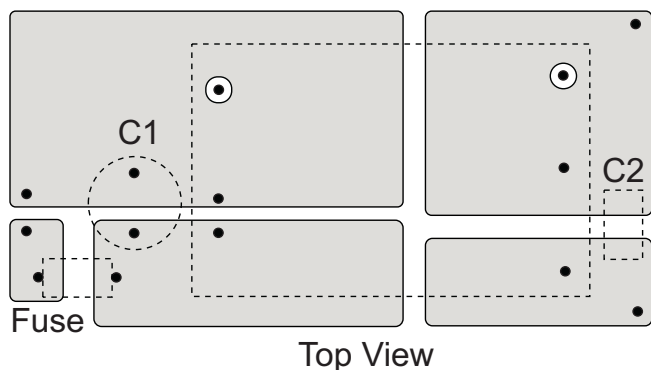

Dual Output

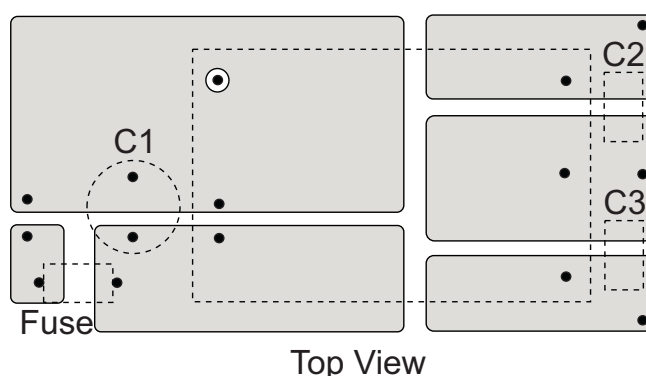

Baseplate Case- suggested PCB layout

Single Output

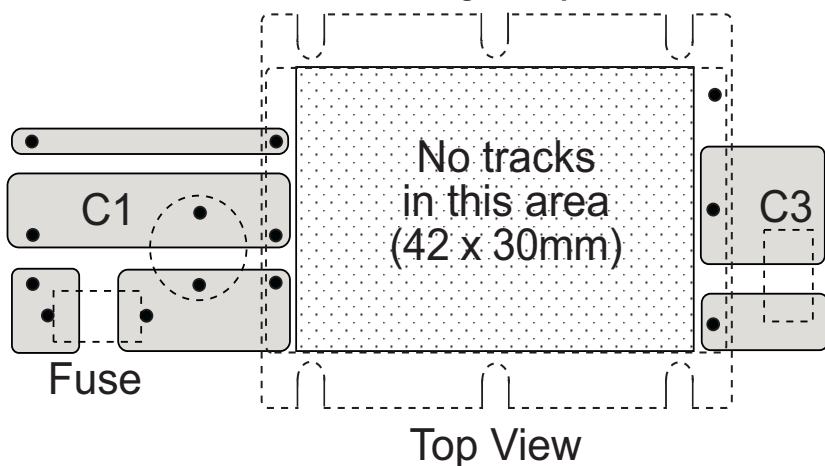

Dual Output

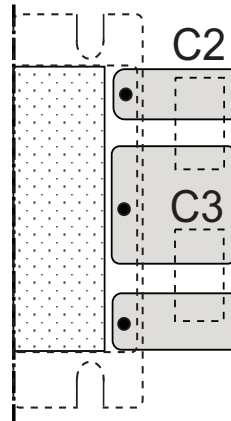

Input Fuse is recommended, but optional. Recommended fuse rating = double maximum input current, time delay type.
 Input Capacitor, C1, is required to meet EN61000 Surge and Fast Transient, otherwise it is not required for normal operation.
 Output Capacitors C2/C3 are recommended, but not required for normal operation. Typical capacitor values are 1µF MLCC
 To ensure optimum thermal performance, use large areas of copper on the PCB to assist with heat dissipation and mount the converter vertically.

POWERLINE+

DC/DC-Converter

RPP30-S_D Series

Package Style and Pinning (mm)

Ribbed Case (Standard - no Suffix)

(Low temperature version = suffix -L)

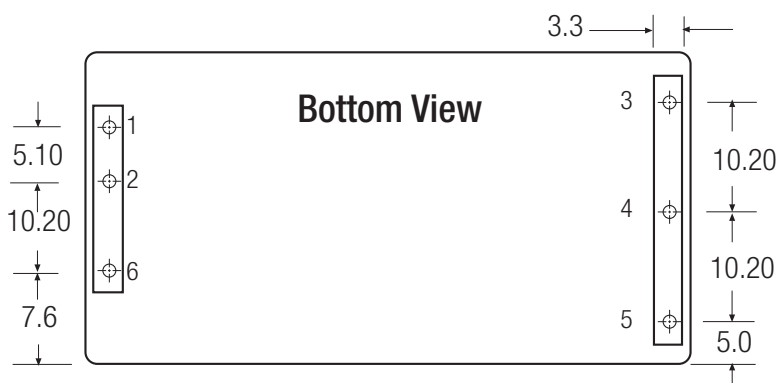
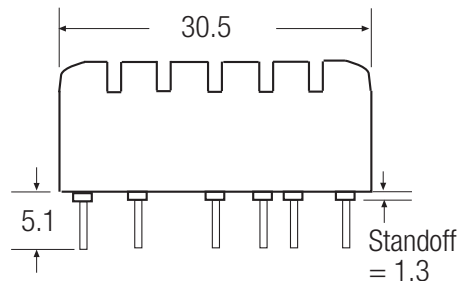
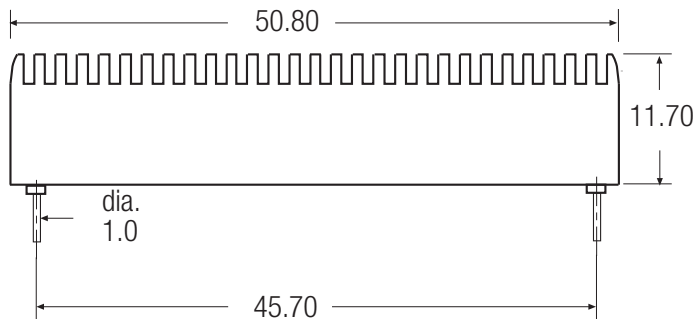

Pin Connections

Pin #	Single	Dual
1	+Vin	+Vin
2	-Vin	-Vin
3	+Vout	+Vout
4	-Vout	Com
5	Trim	-Vout
6	CTRL	CTRL

Pin Pitch Tolerance ± 0.35 mm

Flat Case (-F Suffix)

(Low temperature version = suffix -T)

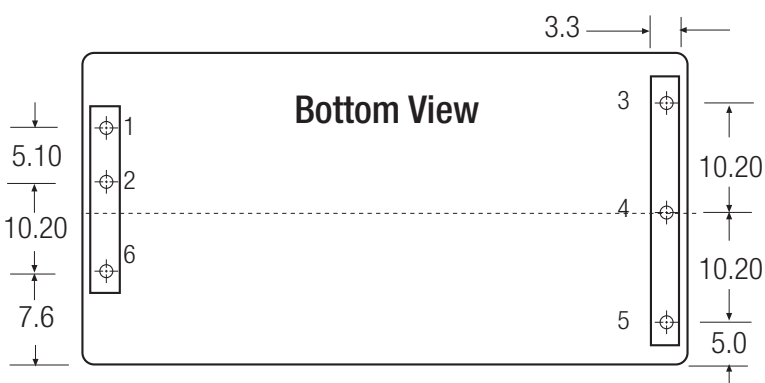
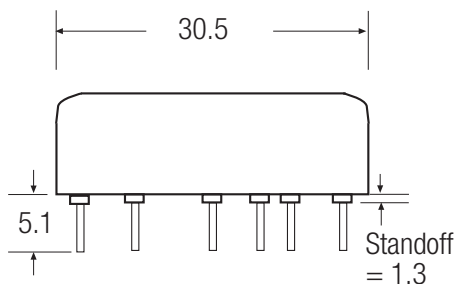
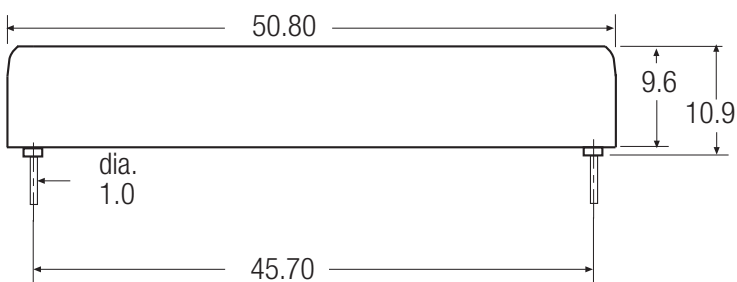

Pin Connections

Pin #	Single	Dual
1	+Vin	+Vin
2	-Vin	-Vin
3	+Vout	+Vout
4	-Vout	Com
5	Trim	-Vout
6	CTRL	CTRL

Pin Pitch Tolerance ± 0.35 mm

RPP30

Package Style and Pinning (mm)

Baseplate Case (-B Suffix)
(Low temperature version = suffix -M)

3rd angle projection 

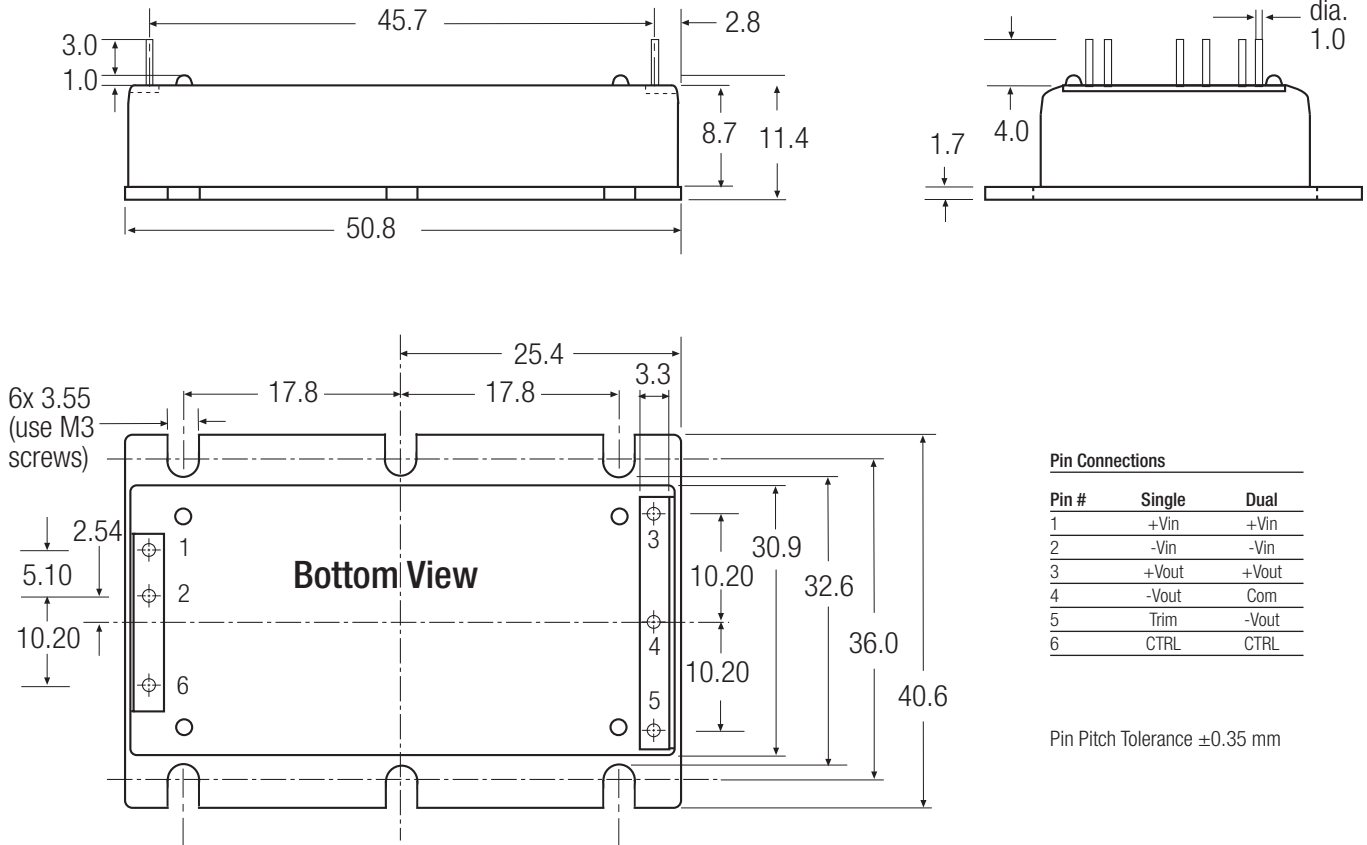

RPP30

Baseplate Case Fixing - Mounting onto Heatsink/Bulkhead

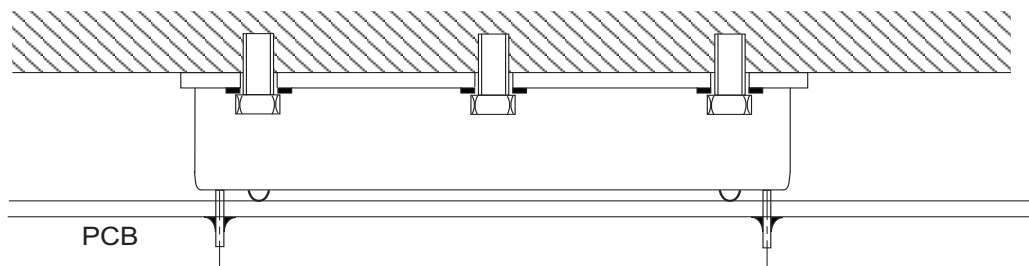

Baseplate Case Fixing - Anti Vibration Mounting onto PCB

