

PTS635 Series 3,5 mm Tact Switches

Features/Benefits

- Compact size 6 x 3.5 mm
- Variety of switch heights
- Choice of actuation force
- RoHS compliant and compatible

Typical Applications

- Consumer products
- Instrumentation
- Computer products
- Industrial

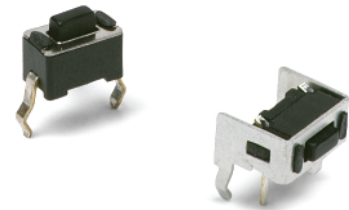

B

Tactile Switches

Specification

FUNCTION: Momentary action
CONTACT ARRANGEMENT: SPST, N.O.
TERMINALS: PC pins

Mechanical

ACTUATION FORCE: PTS635L models: 130 grams.
PTS635H models: 200 grams.
LIFE EXPECTANCY: 20,000 operations.

Electrical

CONTACT RATING: 50 mA @ 12 V DC.
DIELECTRIC STRENGTH: 250 V AC min.
CONTACT RESISTANCE: 100 mΩ max. initial.
INSULATION RESISTANCE: 10¹¹Ω min.

Environmental

OPERATING TEMPERATURE: -40°C to 60°C

NOTE: Specifications listed above are for switches with standard options.
For information on specific and custom switches, consult Customer Service Center.

Process

SOLDERING: Preheating to 100°C for 45 sec. max. Keep flux flush with top surface of PCB; do not apply to component side of PCB and area where terminals are located. Soldering to 255°C for 5 sec. max. Clean by brushing on solder surface. Do not clean switch with solvents.

Materials

BASE: 6/6 nylon or glass filled polyester (PBT) (UL 94V-0).
ACTUATOR: 6/6 nylon or polyacetal (UL 94HB).
COVER PLATE: PTS635S and PTS635V models: Tin plated stainless steel
DOME CONTACTS: Phosphor bronze, silver clad.
STATIONARY CONTACTS: Brass, silver plated.
TERMINALS: Brass, silver plated. Insert molded.

Packaging

Bulk packaging.

Tape & reel for:

PTS635Sx43SMTR, 1700 pcs per reel

How To Order

Our easy build-a-switch concept allows you to mix and match options to create the switch you need. To order, select desired option from each category and place it in the appropriate box.

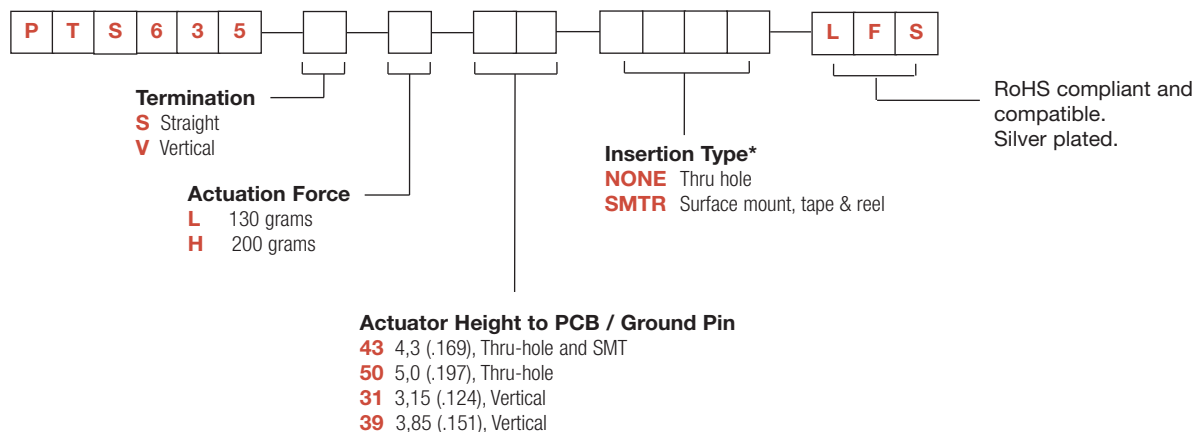

* SMTR only available with PTS635 43 Actuator Height options.

PTS635 Series 3,5 mm Tact Switches

SERIES

PTS635

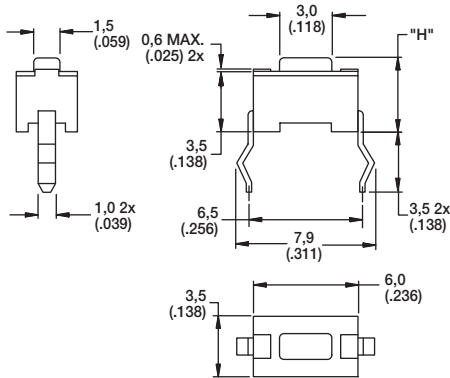

For "H" dimension please refer to chart on next page

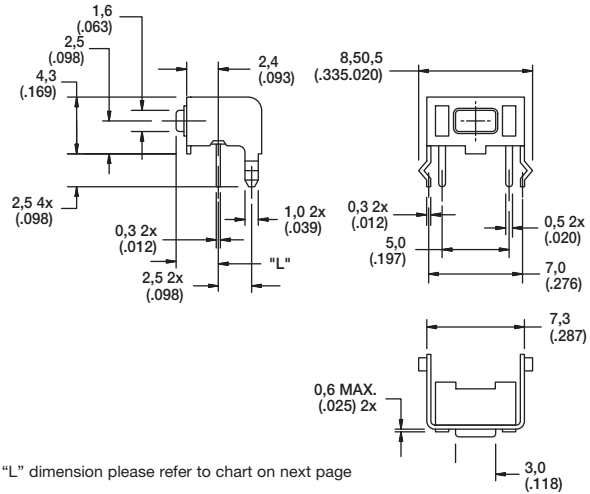

For "L" dimension please refer to chart on next page

Tactile Switches

B

TERMINATION

S STRAIGHT

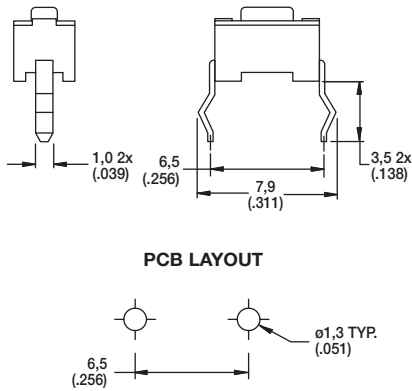

V VERTICAL

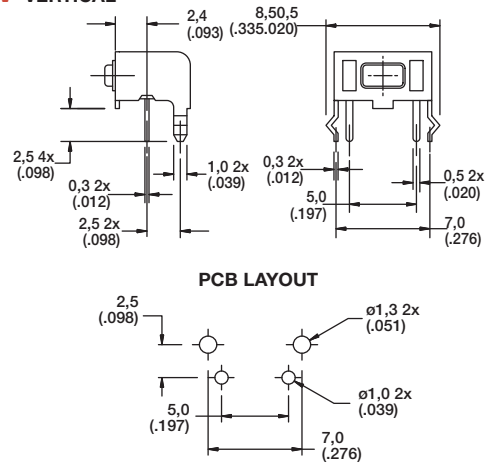

SMT 43

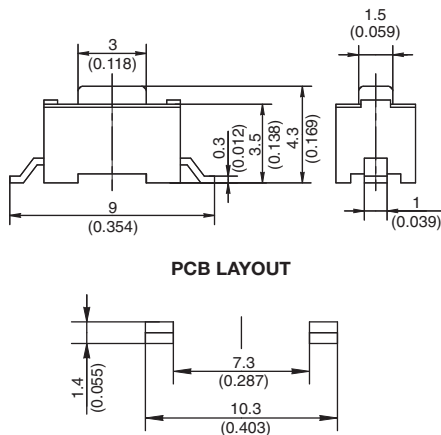

First Angle
Projection

Dimensions are shown: mm (inches)
Specifications and dimensions subject to change

PTS635 Series 3,5 mm Tact Switches



ACTUATION FORCE



OPTION CODE	FORCE
L	130 grams
H	200 grams

ACTUATOR HEIGHT

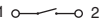

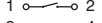
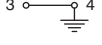
OPTION CODE	HEIGHT "H" or LENGTH "L"	TERMINATION	SCHEMATIC
43	4,3 (.169)	Thru-hole & SMT	1  2
50	5,0 (.197)	Thru-hole	1  2
31	3,15 (.124)	Vertical	1  2
39	3,85 (.151)	Vertical	3  4

INSERTION TYPE



SMTR 43

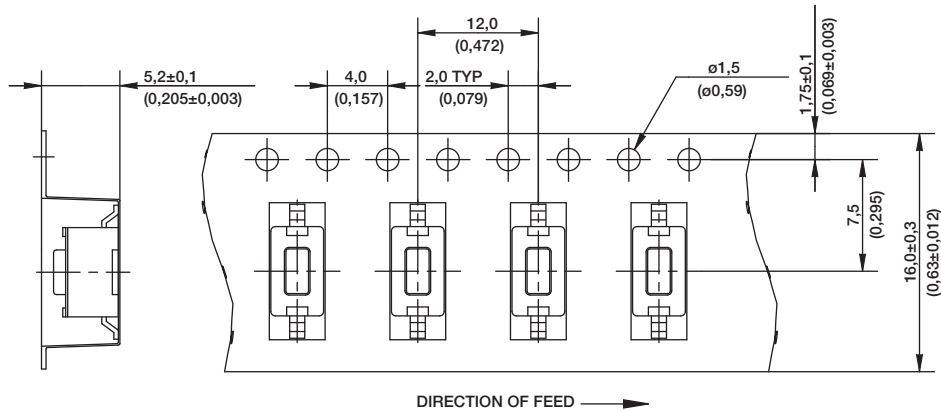

First Angle
Projection

Dimensions are shown: mm (inches)
Specifications and dimensions subject to change