

# NTR0202PL, NVTR0202PL

## Power MOSFET

-20 V, -400 mA, P-Channel  
SOT-23 Package



ON Semiconductor®

<http://onsemi.com>

### Features

- Low  $R_{DS(on)}$  Provides Higher Efficiency and Extends Battery Life  
 $R_{DS(on)} = 0.80 \Omega$ ,  $V_{GS} = -10 \text{ V}$   
 $R_{DS(on)} = 1.10 \Omega$ ,  $V_{GS} = -4.5 \text{ V}$
- Miniature SOT-23 Surface Mount Package Saves Board Space
- AEC-Q101 Qualified and PPAP Capable – NVTR0202PL
- These Devices are Pb-Free and are RoHS Compliant

### Applications

- DC-DC Converters
- Computers
- Printers
- PCMCIA Cards
- Cellular and Cordless Telephones

### MAXIMUM RATINGS ( $T_J = 25^\circ\text{C}$ unless otherwise noted)

Rating	Symbol	Value	Unit
Drain-to-Source Voltage	$V_{DSS}$	-20	V
Gate-to-Source Voltage – Continuous	$V_{GS}$	$\pm 20$	V
Continuous Drain Current @ $T_A = 25^\circ\text{C}$ Pulsed Drain Current ( $t_p \leq 10 \mu\text{s}$ )	$I_D$ $I_{DM}$	-0.4 -1.0	A
Total Power Dissipation @ $T_A = 25^\circ\text{C}$ (Note 1)	$P_D$	225	mW
Operating and Storage Temperature Range	$T_J, T_{stg}$	-55 to 150	$^\circ\text{C}$
Thermal Resistance – Junction-to-Ambient	$R_{\theta JA}$	556	$^\circ\text{C}/\text{W}$
Source Current (Body Diode)	$I_S$	0.4	A
Maximum Lead Temperature for Soldering Purposes, 1/8" from case for 10 s	$T_L$	260	$^\circ\text{C}$

Stresses exceeding Maximum Ratings may damage the device. Maximum Ratings are stress ratings only. Functional operation above the Recommended Operating Conditions is not implied. Extended exposure to stresses above the Recommended Operating Conditions may affect device reliability.

1. Pulse Test: Pulse Width  $\leq 300 \mu\text{s}$ , Duty Cycle  $\leq 2\%$ .

$V_{(BR)DSS}$	$R_{DS(on)}$ Typ	$I_D$ MAX
-20 V	550 m $\Omega$ @ -10 V	-400 mA

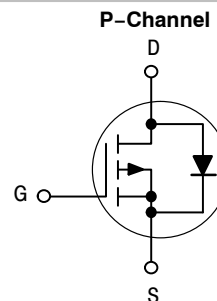

### MARKING DIAGRAM & PIN ASSIGNMENT

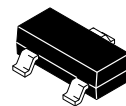

SOT-23  
CASE 318  
STYLE 21

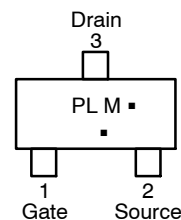

PL = Specific Device Code  
M = Date Code\*  
▪ = Pb-Free Package

(Note: Microdot may be in either location)

\*Date Code orientation may vary depending upon manufacturing location.

### ORDERING INFORMATION

Device	Package	Shipping†
NTR0202PLT1G	SOT-23 (Pb-Free)	3000 / Tape & Reel
NTR0202PLT3G	SOT-23 (Pb-Free)	10000 / Tape & Reel
NVTR0202PLT1G	SOT-23 (Pb-Free)	3000 / Tape & Reel

†For information on tape and reel specifications, including part orientation and tape sizes, please refer to our Tape and Reel Packaging Specification Brochure, BRD8011/D.

# NTR0202PL, NVTR0202PL

## ELECTRICAL CHARACTERISTICS (T<sub>A</sub> = 25°C unless otherwise noted)

Characteristic	Symbol	Min	Typ	Max	Unit
----------------	--------	-----	-----	-----	------

### OFF CHARACTERISTICS

Drain-to-Source Breakdown Voltage (V <sub>GS</sub> = 0 V, I <sub>D</sub> = -10 μA) (Positive Temperature Coefficient)	V <sub>(BR)DSS</sub>	-20	33		V mV/°C
Zero Gate Voltage Drain Current (V <sub>DS</sub> = -20 V, V <sub>GS</sub> = 0 V, T <sub>J</sub> = 25°C) (V <sub>DS</sub> = -20 V, V <sub>GS</sub> = 0 V, T <sub>J</sub> = 150°C)	I <sub>DSS</sub>			-1.0 -10	μA
Gate-Body Leakage Current (V <sub>GS</sub> = ±20 V, V <sub>DS</sub> = 0 V)	I <sub>GSS</sub>			±100	nA

### ON CHARACTERISTICS (Note 2)

Gate Threshold Voltage (V <sub>DS</sub> = V <sub>GS</sub> , I <sub>D</sub> = -250 μA) (Negative Temperature Coefficient)	V <sub>GS(th)</sub>	-1.1	-1.9 3.0	-2.3	V mV/°C
Static Drain-to-Source On-Resistance (V <sub>GS</sub> = -10 V, I <sub>D</sub> = -200 mA) (V <sub>GS</sub> = -4.5 V, I <sub>D</sub> = -50 mA)	R <sub>DS(on)</sub>		0.55 0.80	0.80 1.10	Ω
Forward Transconductance (V <sub>DS</sub> = -10 V, I <sub>D</sub> = -200 mA)	g <sub>fs</sub>		0.5		Mhos

### DYNAMIC CHARACTERISTICS

Input Capacitance	(V <sub>DS</sub> = -5.0 V, V <sub>GS</sub> = 0 V, F = 1.0 MHz)	C <sub>iss</sub>	70		pF
Output Capacitance		C <sub>oss</sub>	74		
Reverse Transfer Capacitance		C <sub>rss</sub>	26		

### SWITCHING CHARACTERISTICS (Note 3)

Turn-On Delay Time	(V <sub>DD</sub> = -15 V, I <sub>D</sub> = -200 mA, V <sub>GS</sub> = -10 V, R <sub>G</sub> = 6.0 Ω)	t <sub>d(on)</sub>	3.0		ns
Rise Time		t <sub>r</sub>	6.0		
Turn-Off Delay Time		t <sub>d(off)</sub>	18		
Fall Time		t <sub>f</sub>	4		
Total Gate Charge	(V <sub>DS</sub> = -15 V, I <sub>D</sub> = -200 mA, V <sub>GS</sub> = -10 V)	Q <sub>TOT</sub>	2.18		nC
Gate-Source Charge		Q <sub>GS</sub>	0.41		
Gate-Drain Charge		Q <sub>GD</sub>	0.40		

### BODY-DRAIN DIODE CHARACTERISTICS (Note 2)

Diode Forward Voltage (Note 2) (I <sub>S</sub> = -400 mA, V <sub>GS</sub> = 0 V) (I <sub>S</sub> = -400 mA, V <sub>GS</sub> = 0 V, T <sub>J</sub> = 150°C)	V <sub>SD</sub>		-0.8 -0.65	-1.0	V
Reverse Recovery Time	(I <sub>S</sub> = -1.0 A, V <sub>GS</sub> = 0 V, dI <sub>S</sub> /dt = 100 A/μs)	t <sub>rr</sub>	11.8		ns
		t <sub>a</sub>	9		
		t <sub>b</sub>	3		
Reverse Recovery Stored Charge	(I <sub>S</sub> = -1.0 A, V <sub>GS</sub> = 0 V, dI <sub>S</sub> /dt = 100 A/μs)	Q <sub>RR</sub>	0.007		μC

2. Pulse Test: Pulse Width ≤ 300 μs, Duty Cycle ≤ 2%.
3. Switching characteristics are independent of operating junction temperature.

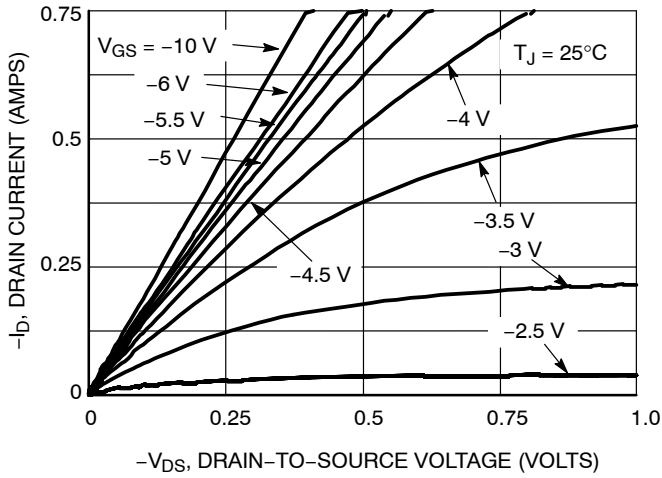

Figure 1. On-Region Characteristics

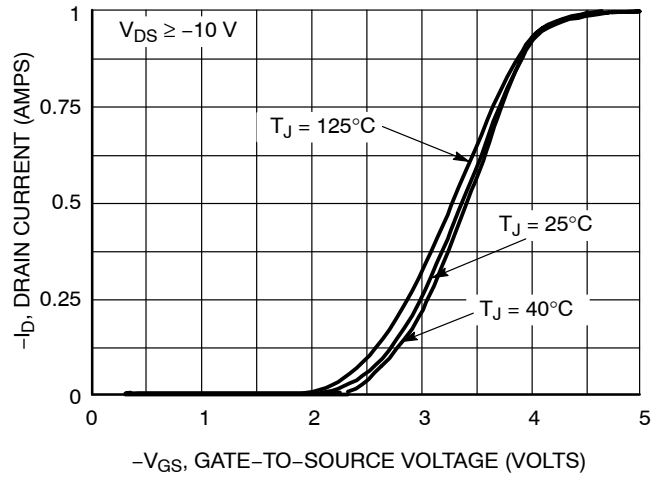

Figure 2. Transfer Characteristics

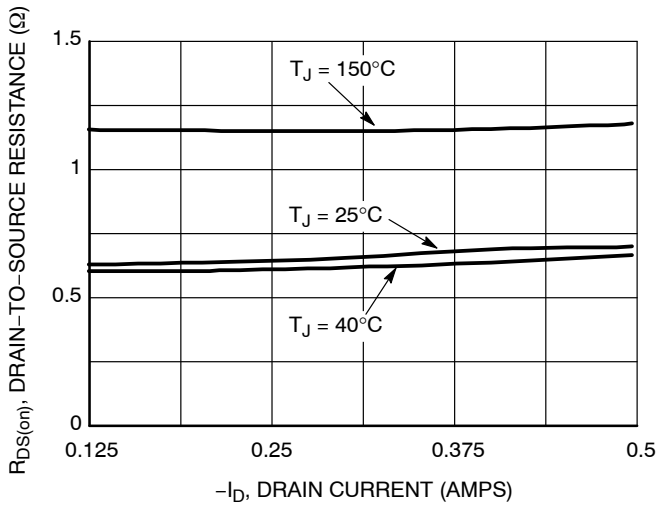

Figure 3. On-Resistance versus Drain Current

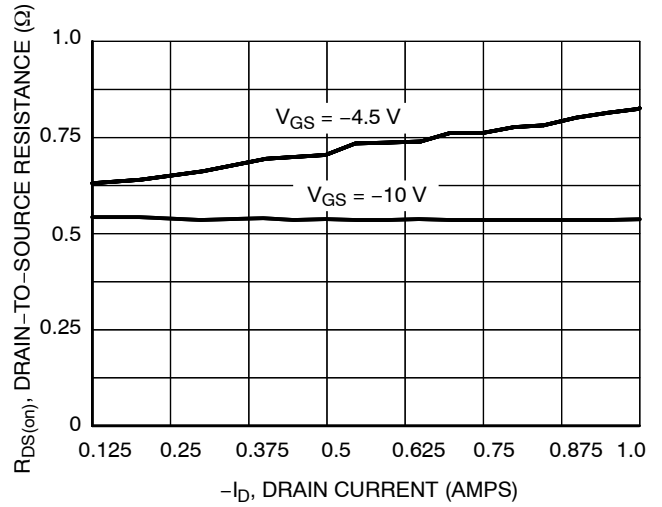

Figure 4. On-Resistance versus Drain Current and Gate Voltage

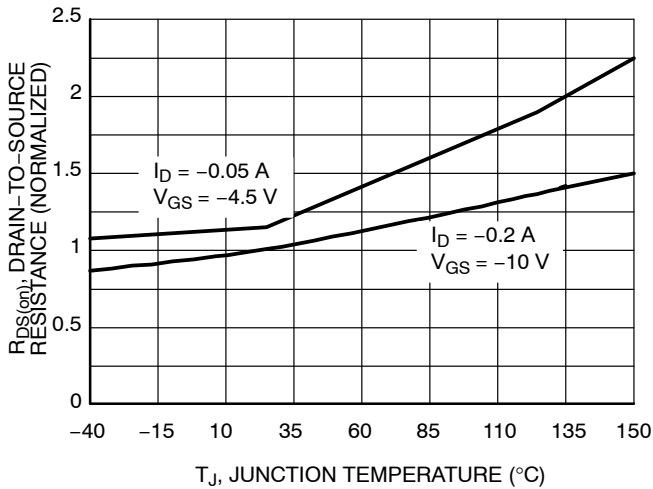

Figure 5. On-Resistance Variation with Temperature

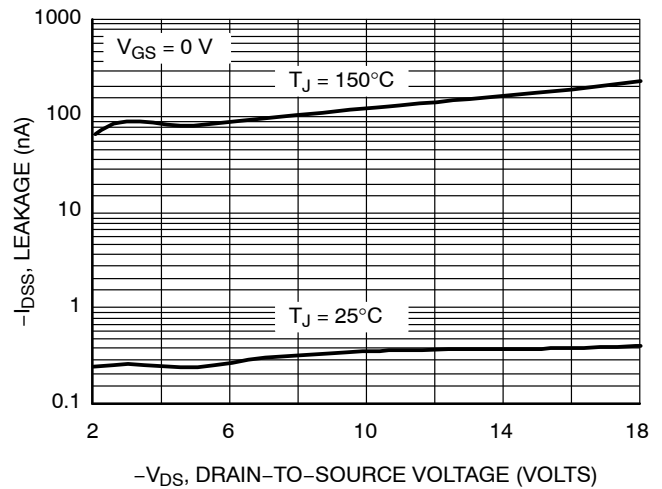
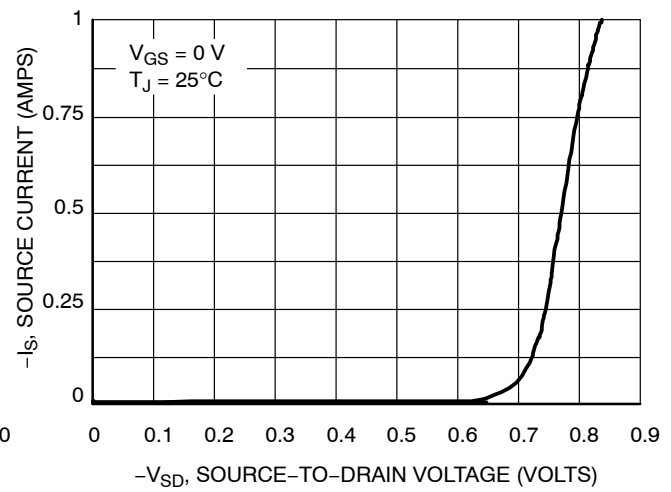
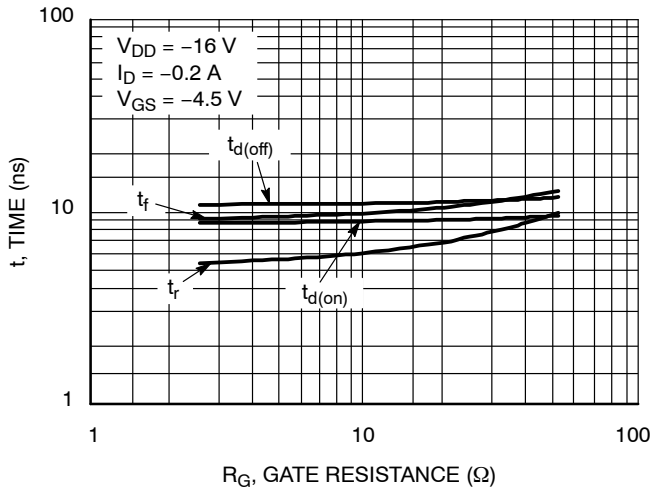
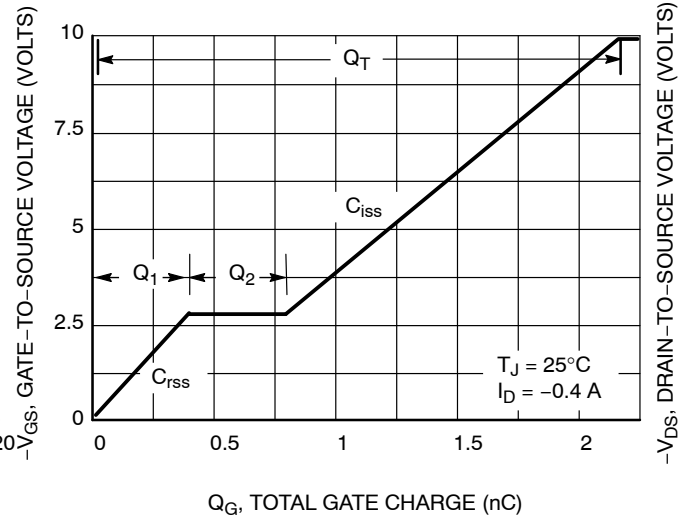
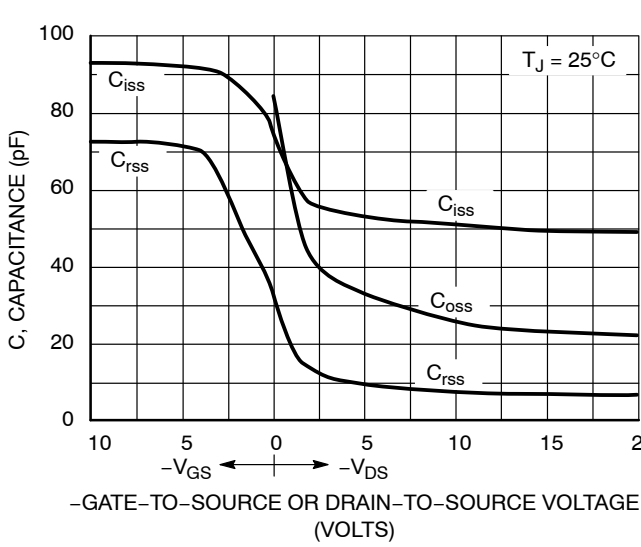

Figure 6. Drain-to-Source Leakage Current versus Voltage



# NTR0202PL, NVTR0202PL

## PACKAGE DIMENSIONS

SOT-23 (TO-236)  
CASE 318-08  
ISSUE AP

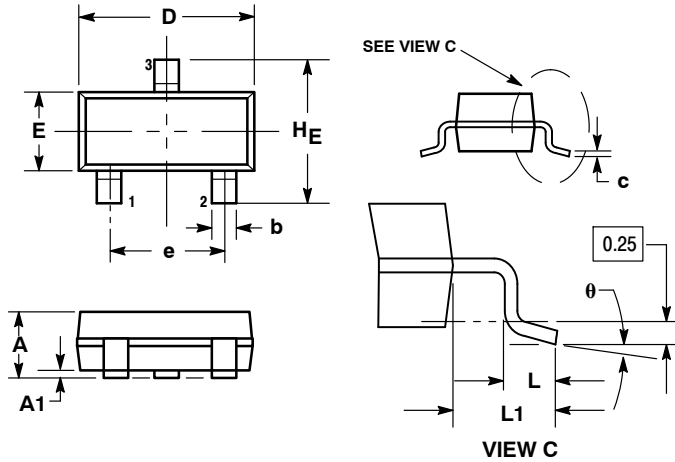

- NOTES:
1. DIMENSIONING AND TOLERANCING PER ANSI Y14.5M, 1982.
  2. CONTROLLING DIMENSION: INCH.
  3. MAXIMUM LEAD THICKNESS INCLUDES LEAD FINISH THICKNESS. MINIMUM LEAD THICKNESS IS THE MINIMUM THICKNESS OF BASE MATERIAL.
  4. DIMENSIONS D AND E DO NOT INCLUDE MOLD FLASH, PROTRUSIONS, OR GATE BURRS.

DIM	MILLIMETERS			INCHES		
	MIN	NOM	MAX	MIN	NOM	MAX
A	0.89	1.00	1.11	0.035	0.040	0.044
A1	0.01	0.06	0.10	0.001	0.002	0.004
b	0.37	0.44	0.50	0.015	0.018	0.020
c	0.09	0.13	0.18	0.003	0.005	0.007
D	2.80	2.90	3.04	0.110	0.114	0.120
E	1.20	1.30	1.40	0.047	0.051	0.055
e	1.78	1.90	2.04	0.070	0.075	0.081
L	0.10	0.20	0.30	0.004	0.008	0.012
L1	0.35	0.54	0.69	0.014	0.021	0.029
HE	2.10	2.40	2.64	0.083	0.094	0.104
θ	0°	---	10°	0°	---	10°

- STYLE 21:  
PIN 1. GATE  
2. SOURCE  
3. DRAIN

### SOLDERING FOOTPRINT\*

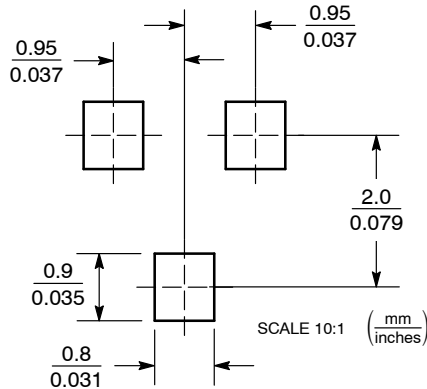

\*For additional information on our Pb-Free strategy and soldering details, please download the ON Semiconductor Soldering and Mounting Techniques Reference Manual, SOLDERRM/D.

ON Semiconductor and are registered trademarks of Semiconductor Components Industries, LLC (SCILLC). SCILLC reserves the right to make changes without further notice to any products herein. SCILLC makes no warranty, representation or guarantee regarding the suitability of its products for any particular purpose, nor does SCILLC assume any liability arising out of the application or use of any product or circuit, and specifically disclaims any and all liability, including without limitation special, consequential or incidental damages. "Typical" parameters which may be provided in SCILLC data sheets and/or specifications can and do vary in different applications and actual performance may vary over time. All operating parameters, including "Typicals" must be validated for each customer application by customer's technical experts. SCILLC does not convey any license under its patent rights nor the rights of others. SCILLC products are not designed, intended, or authorized for use as components in systems intended for surgical implant into the body, or other applications intended to support or sustain life, or for any other application in which the failure of the SCILLC product could create a situation where personal injury or death may occur. Should Buyer purchase or use SCILLC products for any such unintended or unauthorized application, Buyer shall indemnify and hold SCILLC and its officers, employees, subsidiaries, affiliates, and distributors harmless against all claims, costs, damages, and expenses, and reasonable attorney fees arising out of, directly or indirectly, any claim of personal injury or death associated with such unintended or unauthorized use, even if such claim alleges that SCILLC was negligent regarding the design or manufacture of the part. SCILLC is an Equal Opportunity/Affirmative Action Employer. This literature is subject to all applicable copyright laws and is not for resale in any manner.

### PUBLICATION ORDERING INFORMATION

LITERATURE FULFILLMENT:  
Literature Distribution Center for ON Semiconductor  
P.O. Box 5163, Denver, Colorado 80217 USA  
Phone: 303-675-2175 or 800-344-3860 Toll Free USA/Canada  
Fax: 303-675-2176 or 800-344-3867 Toll Free USA/Canada  
Email: orderlit@onsemi.com

N. American Technical Support: 800-282-9855 Toll Free  
USA/Canada  
Europe, Middle East and Africa Technical Support:  
Phone: 421 33 790 2910  
Japan Customer Focus Center  
Phone: 81-3-5817-1050

ON Semiconductor Website: [www.onsemi.com](http://www.onsemi.com)  
Order Literature: <http://www.onsemi.com/orderlit>  
For additional information, please contact your local Sales Representative