

Notice for TAIYO YUDEN products

Please read this notice before using the TAIYO YUDEN products.

REMINDERS

- Product information in this catalog is as of October 2011. All of the contents specified herein are subject to change without notice due to technical improvements, etc. Therefore, please check for the latest information carefully before practical application or usage of the Products.

Please note that Taiyo Yuden Co., Ltd. shall not be responsible for any defects in products or equipment incorporating such products, which are caused under the conditions other than those specified in this catalog or individual specification.

- Please contact Taiyo Yuden Co., Ltd. for further details of product specifications as the individual specification is available.
- Please conduct validation and verification of products in actual condition of mounting and operating environment before commercial shipment of the equipment.

- All electronic components or functional modules listed in this catalog are developed, designed and intended for use in general electronics equipment.(for AV, office automation, household, office supply, information service, telecommunications, (such as mobile phone or PC) etc.). Before incorporating the components or devices into any equipment in the field such as transportation,(automotive control, train control, ship control), transportation signal, disaster prevention, medical, public information network (telephone exchange, base station) etc. which may have direct influence to harm or injure a human body, please contact Taiyo Yuden Co., Ltd. for more detail in advance. Do not incorporate the products into any equipment in fields such as aerospace, aviation, nuclear control, submarine system, military, etc. where higher safety and reliability are especially required.

In addition, even electronic components or functional modules that are used for the general electronic equipment, if the equipment or the electric circuit require high safety or reliability function or performances, a sufficient reliability evaluation check for safety shall be performed before commercial shipment and moreover, due consideration to install a protective circuit is strongly recommended at customer's design stage.

- The contents of this catalog are applicable to the products which are purchased from our sales offices or distributors (so called "TAIYO YUDEN' s official sales channel"). It is only applicable to the products purchased from any of TAIYO YUDEN' s official sales channel.

- Please note that Taiyo Yuden Co., Ltd. shall have no responsibility for any controversies or disputes that may occur in connection with a third party's intellectual property rights and other related rights arising from your usage of products in this catalog. Taiyo Yuden Co., Ltd. grants no license for such rights.

- Caution for export

Certain items in this catalog may require specific procedures for export according to "Foreign Exchange and Foreign Trade Control Law" of Japan, "U.S. Export Administration Regulations", and other applicable regulations. Should you have any question or inquiry on this matter, please contact our sales staff.

SMD POWER INDUCTORS (NR SERIES/NR SERIES H TYPE/S TYPE/V TYPE)



REFLOW

FEATURES

- Small and Low profile inductor.
- It corresponds to High current.
- Simple and original magnetic shield structure.
- Durable structure against dropping impact.

APPLICATIONS

- For small DC/DC converter (cellular Phone, HDD, DVC, DSC, PDA, LCD display etc).

OPERATING TEMP.

- NR/NRS20/NRV20/NRH24/NRH30/NRV3012 : -25°C~120°C (Including self-generated heat)
- NRS40/50/60/80 : -25°C~125°C (Including self-generated heat)

ORDERING CODE

N R \triangle 4 0 1 8 T \triangle 1 0 0 M \triangle

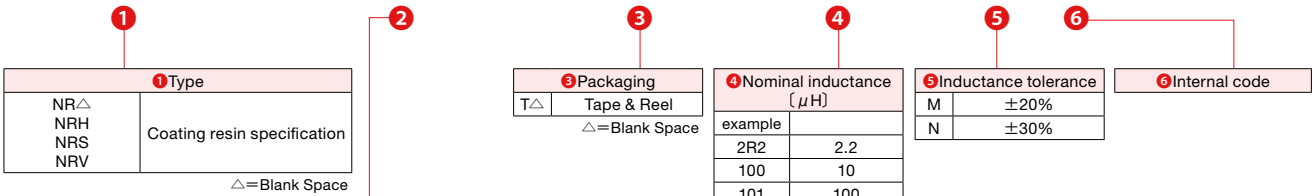

2 External dimensions (W×L×H)

2012	2.0×2.0×1.2 mm	5020	4.9×4.9×2.0 mm
2410	2.4×2.4×1.0 mm	5024	4.9×4.9×2.4 mm
2412	2.4×2.4×1.2 mm	5040	4.9×4.9×4.0 mm
3010	3.0×3.0×1.0 mm	6010	6.0×6.0×1.0 mm
3012	3.0×3.0×1.2 mm	6012	6.0×6.0×1.2 mm
4010	4.0×4.0×1.0 mm	6014	6.0×6.0×1.4 mm
4012	4.0×4.0×1.2 mm	6020	6.0×6.0×2.0 mm
4018	4.0×4.0×1.8 mm	6028	6.0×6.0×2.8 mm
5010	4.9×4.9×1.0 mm	6045	6.0×6.0×4.5 mm
5012	4.9×4.9×1.2 mm	8030	8.0×8.0×3.0 mm
5014	4.9×4.9×1.4 mm	8040	8.0×8.0×4.0 mm

EXTERNAL DIMENSIONS/STANDARD QUANTITY

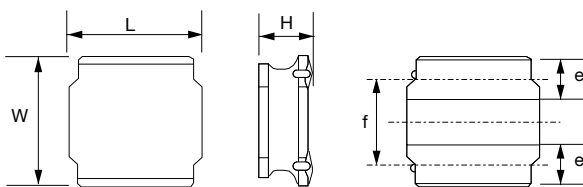

Type	L	W	H	e	f	Standard Quantity [pcs] Tape & Reel
NRS2012	2.0±0.1 (0.079±0.004)	2.0±0.1 (0.079±0.004)	1.2 max (0.047 max)	0.5±0.2 (0.020±0.008)	1.25±0.2 (0.050±0.008)	2500
NRV2012						
NRH2410	2.4±0.1 (0.095±0.004)	2.4±0.1 (0.095±0.004)	1.0 max (0.039 max)	0.6±0.2 (0.024±0.008)	1.45±0.2 (0.057±0.008)	2500
NRH2412			1.2 max (0.047 max)			
NR 3010	3.0±0.1 (0.118±0.004)	3.0±0.1 (0.118±0.004)	1.0 max (0.039 max)	0.9±0.2 (0.035±0.008)	1.9±0.2 (0.075±0.008)	2000
NRH3010						
NR3012			1.2 max (0.047 max)			
NRH3012						
NRV3012			1.5 max (0.059 max)			2000
NR 3015						
NR 4010	4.0±0.2 (0.157±0.008)	4.0±0.2 (0.157±0.008)	1.0 max (0.039 max)	1.1±0.2 (0.043±0.008)	2.5±0.2 (0.098±0.008)	5000
NRS4010						
NR 4012			1.2 max (0.047 max)			
NRS4012						
NR 4018			1.8 max (0.071 max)			3500
NRS4018						
NRS8030	8.0±0.2 (0.315±0.008)	8.0±0.2 (0.315±0.008)	3.0 max (0.118 max)	1.60±0.3 (0.063±0.012)	5.6±0.3 (0.22±0.012)	1000
NR 8040			4.2 max (0.165 max)			1000
NRS8040			4.0 max (0.157 max)			

*1) 0R9~6R8 Type
*2) 100~101 Type

Unit : mm (inch)

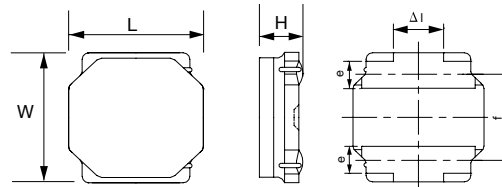

Type	L	W	H	e	f	Δ l	Standard Quantity [pcs] Tape & Reel					
NRS5010	4.9±0.2 (0.193±0.008)	4.9±0.2 (0.193±0.008)	1.0 max (0.039 max)	1.2±0.2 (0.047±0.008)	3.3±0.2 (0.130±0.008)	1.3typ (0.051typ)	1000					
NRS5012			1.2 max (0.047 max)				1000					
NRS5014			1.4 max (0.055 max)				1000					
NRS5020			2.0 max (0.079 max)				800					
NRS5024			2.4 max (0.094 max)				2500					
NR 5040			4.1 max (0.161 max)				1500					
NRS5040			4.0 max (0.157 max)									
NRS6010			6.0±0.2 (0.236±0.008)				6.0±0.2 (0.236±0.008)	1.0 max (0.039 max)	1.35±0.2 (0.053±0.008)	4.0±0.2 (0.157±0.008)	2.3typ (0.091typ)	1000
NR 6012								1.2 max (0.047 max)				1000
NRS6012												
NRS6014	1.4 max (0.055 max)	1000										
NR 6020	2.0 max (0.079 max)	2500										
NRS6020												
NR 6028	2.8 max (0.110 max)	2000										
NRS6028												
NR 6045	4.5 max (0.177 max)	1500										
NRS6045												

*3) 1R5~100Type
*4) 150~470Type

Unit : mm (inch)

* This catalog contains the typical specification only due to the limitation of space. When you consider the purchase of our products, please check our specification. For details of each product (characteristics graph, reliability information, precautions for use, and so on), see our Web site (<http://www.ty-top.com/>) or CD catalogs.

Recommended Land Patterns

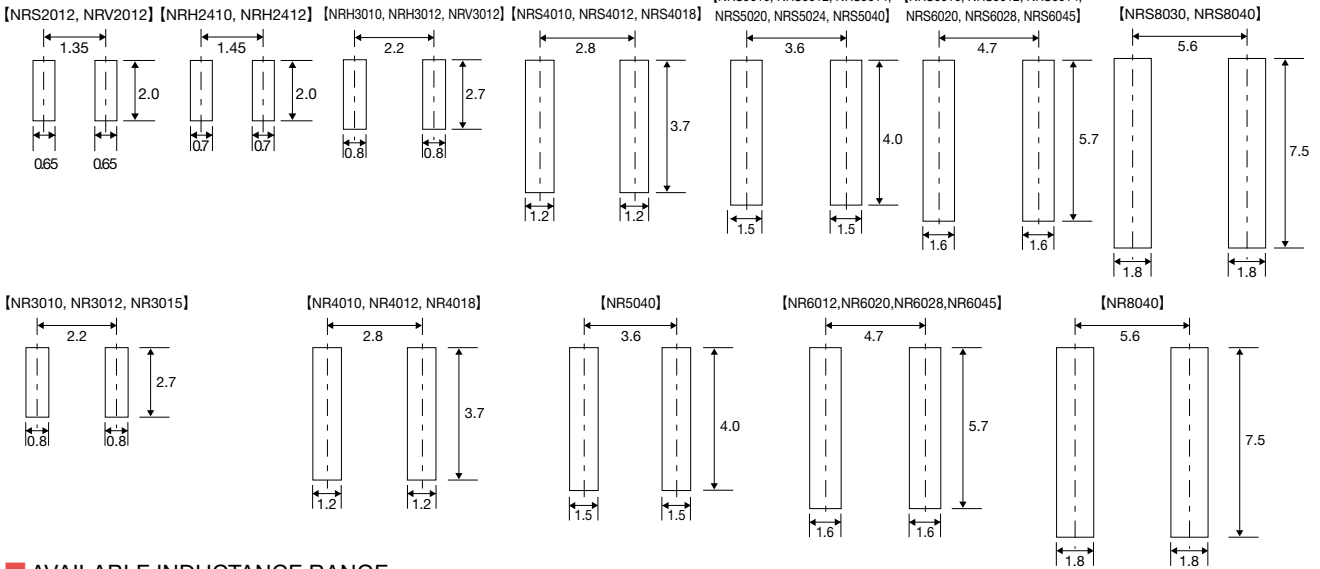

AVAILABLE INDUCTANCE RANGE

Range	Type	NRS2012		NRV2012		NRH2410		NRH2412		NRH3010		NRH3012		NRV3012		NRS4010									
		I _{max} [mA]	R _{dc} ±20% [Ω]	I _{max} [mA]	R _{dc} ±20% [Ω]	I _{max} [mA]	R _{dc} ±20% [Ω]	I _{max} [mA]	R _{dc} ±20% [Ω]	I _{max} [mA]	R _{dc} ±20% [Ω]	I _{max} [mA]	R _{dc} ±20% [Ω]	I _{max} [mA]	R _{dc} ±20% [Ω]	I _{max} [mA]	R _{dc} ±20% [Ω]								
Inductance [μH]	0.68	1700	0.070	1650	0.073	1570	0.060	1300	0.077	1480	0.065	1710	0.048	1600	0.065	1900	0.056								
	1.0	910	0.241	750	0.325			650	0.300																
	4.7					450	0.690	450	0.600	600	0.350	720	0.270	550	0.470	620	0.300								
	10									380	0.770														
	22					300	1.47					500	0.630			450	0.570								
100																									
Range	Type	NRS4012		NRS4018		NRS5010		NRS5012		NRS5014		NRS5020		NRS5024		NRS5040									
		I _{max} [mA]	R _{dc} ±20% [Ω]	I _{max} [mA]	R _{dc} ±20% [Ω]	I _{max} [mA]	R _{dc} ±20% [Ω]	I _{max} [mA]	R _{dc} ±20% [Ω]	I _{max} [mA]	R _{dc} ±20% [Ω]	I _{max} [mA]	R _{dc} ±20% [Ω]	I _{max} [mA]	R _{dc} ±30% [Ω]	I _{max} [mA]	R _{dc} ±30% [Ω]								
Inductance [μH]	0.68	2200	0.042	3200	0.027	1750	0.070	2300	0.053	2800	0.045	3600	0.021	4400	0.016	4500	0.017								
	1.0	800	0.170	1200	0.150	850	0.250	850	0.420	1050	0.200	1300	0.120	1200	0.125	2100	0.056								
	4.7							640	0.670																
	10											900	0.260	630	0.370										
	22	500	0.400	550	0.460	450	0.600									900	0.31								
100																									
Range	Type	NRS6010		NRS6012		NRS6014		NRS6020		NRS6028		NRS6045		NRS8030		NRS8040									
		I _{max} [mA]	R _{dc} ±20% [Ω]	I _{max} [mA]	R _{dc} ±20% [Ω]	I _{max} [mA]	R _{dc} ±20% [Ω]	I _{max} [mA]	R _{dc} ±20% [Ω]	I _{max} [mA]	R _{dc} ±30% [Ω]	I _{max} [mA]	R _{dc} ±30% [Ω]	I _{max} [mA]	R _{dc} ±30% [Ω]	I _{max} [mA]	R _{dc} ±30% [Ω]								
Inductance [μH]	1.0	1900	0.090	1800	0.090	2750	0.042	4100	0.020	4600	0.013	4500	0.014			7800	0.006								
	4.7																								
	10	1000	0.270	1000	0.200	1800	0.140	1500	0.125	1900	0.065	2400	0.046	2400	0.033	3100	0.034								
	22	700	0.580			950	0.300	950	0.290					1100	0.170	2200	0.066								
	100			320	1.670						650	0.600	750	0.466											
Range	Type	NR 3010		NR 3012		NR 3015		NR 4010		NR 4012		NR 4018		NR 5040		NR 6012		NR 6020		NR 6028		NR 6045		NR 8040	
		I _{MAX} [mA]	R _{dc} ±20% [Ω]	I _{MAX} [mA]	R _{dc} ±20% [Ω]	I _{MAX} [mA]	R _{dc} ±20% [Ω]	I _{MAX} [mA]	R _{dc} ±20% [Ω]	I _{MAX} [mA]	R _{dc} ±20% [Ω]	I _{MAX} [mA]	R _{dc} ±20% [Ω]	I _{MAX} [mA]	R _{dc} ±30% [Ω]	I _{MAX} [mA]	R _{dc} ±20% [Ω]	I _{MAX} [mA]	R _{dc} ±30% [Ω]	I _{MAX} [mA]	R _{dc} ±30% [Ω]	I _{MAX} [mA]	R _{dc} ±30% [Ω]	I _{MAX} [mA]	R _{dc} ±30% [Ω]
Inductance [μH]	0.8	1300	0.065	1490	0.05	2100	0.030	1050	0.100	1500	0.060	1830	0.030												
	1.0													3600	0.020										
	3.3													1730	0.090										
	10	500	0.450	540	0.290	700	0.230	560	0.380	740	0.240	840	0.180	2100	0.056	1000	0.235	1400	0.125	1900	0.065	2500	0.047	3100	0.034
	47	220	2.05	250	1.45	300	1.34	240	1.81	350	1.00			900	0.310			950	0.290						
100																									
220																									

* This catalog contains the typical specification only due to the limitation of space. When you consider the purchase of our products, please check our specification. For details of each product (characteristics graph, reliability information, precautions for use, and so on), see our Web site (<http://www.ty-top.com/>) or CD catalogs.

PART NUMBERS

● NRS2012 Shielded type

Ordering code	EHS (Environmental Hazardous Substances)	Inductance [μ H]	Inductance Tolerance	DC Resistance [Ω] ($\pm 20\%$)	Rated current ※) [mA]		Measuring frequency [kHz]
					Saturation current Idc1	Temperature rise current Idc2	
NRS2012T 1R0N GJ	RoHS	1.0	$\pm 30\%$	0.070	1,900	1,700	100
NRS2012T 1R5N GJ	RoHS	1.5		0.090	1,650	1,500	
NRS2012T 2R2M GJ	RoHS	2.2	$\pm 20\%$	0.107	1,350	1,370	
NRS2012T 3R3M GJ	RoHS	3.3		0.190	1,000	1,020	
NRS2012T 4R7M GJ	RoHS	4.7		0.241	900	910	

● NRV2012 type

Ordering code	EHS (Environmental Hazardous Substances)	Inductance [μ H]	Inductance Tolerance	DC Resistance [Ω] ($\pm 20\%$)	Rated current ※) [mA]		Measuring frequency [kHz]
					Saturation current Idc1	Temperature rise current Idc2	
NRV2012T 1R0N GF	RoHS	1.0	$\pm 30\%$	0.073	2,200	1,650	100
NRV2012T 1R5N GF	RoHS	1.5		0.100	1,800	1,400	
NRV2012T 2R2M GF	RoHS	2.2	$\pm 20\%$	0.129	1,600	1,200	
NRV2012T 3R3M GF	RoHS	3.3		0.227	1,250	900	
NRV2012T 4R7M GF	RoHS	4.7		0.325	1,100	750	

● NRH2410 Shielded type

Ordering code	EHS (Environmental Hazardous Substances)	Inductance [μ H]	Inductance Tolerance	Self-resonant frequency [MHz] (min.)	DC Resistance [Ω] ($\pm 20\%$)	Rated current ※) [mA]		Measuring frequency [kHz]
						Saturation current Idc1	Temperature rise current Idc2	
NRH2410T R68NN 4	RoHS	0.68	$\pm 30\%$	120	0.060	2,200	1,570	100
NRH2410T 1R0NN 4	RoHS	1.0		106	0.070	1,800	1,410	
NRH2410T 1R5MN	RoHS	1.5	$\pm 20\%$	94	0.110	1,550	1,160	
NRH2410T 2R2MN	RoHS	2.2		77	0.150	1,290	970	
NRH2410T 3R3MN	RoHS	3.3		56	0.220	1,000	770	
NRH2410T 4R7MN	RoHS	4.7		50	0.290	880	670	
NRH2410T 6R8MN	RoHS	6.8		43	0.410	750	570	
NRH2410T 100MN	RoHS	10		32	0.690	550	450	
NRH2410T 150MN	RoHS	15		27	1.02	470	370	
NRH2410T 220MN	RoHS	22		22	1.47	390	300	

● NRH2412 Shielded type

Ordering code	EHS (Environmental Hazardous Substances)	Inductance [μ H]	Inductance Tolerance	Self-resonant frequency [MHz] (min.)	DC Resistance [Ω] ($\pm 20\%$)	Rated current ※) [mA]		Measuring frequency [kHz]
						Saturation current Idc1	Temperature rise current Idc2	
NRH2412T 1R0NNGH	RoHS	1.0	$\pm 30\%$	101	0.077	2,350	1,300	100
NRH2412T 1R5NNGH	RoHS	1.5		89	0.100	2,100	1,150	
NRH2412T 2R2MNGH	RoHS	2.2	$\pm 20\%$	72	0.140	1,700	1,000	
NRH2412T 3R3MNGH	RoHS	3.3		56	0.225	1,400	750	
NRH2412T 4R7MNGH	RoHS	4.7		45	0.300	1,150	650	
NRH2412T 6R8MNGH	RoHS	6.8		34	0.420	950	550	
NRH2412T 100MNGH	RoHS	10		29	0.600	810	450	

● NRH3010 Shielded type

Ordering code	EHS (Environmental Hazardous Substances)	Inductance [μ H]	Inductance Tolerance	Self-resonant frequency [MHz] (min.)	DC Resistance [Ω] ($\pm 20\%$)	Rated current ※) [mA]		Measuring frequency [kHz]
						Saturation current Idc1	Temperature rise current Idc2	
NRH3010T 1R2NN	RoHS	1.2	$\pm 30\%$	120	0.065	1,700	1,480	100
NRH3010T 1R5NN	RoHS	1.5		99	0.075	1,440	1,370	
NRH3010T 2R2MN	RoHS	2.2	$\pm 20\%$	86	0.083	1,300	1,300	
NRH3010T 3R3MN	RoHS	3.3		64	0.130	1,000	1,030	
NRH3010T 4R7MN	RoHS	4.7		50	0.170	850	900	
NRH3010T 6R8MN	RoHS	6.8		44	0.250	700	745	
NRH3010T 100MN	RoHS	10		34	0.350	600	620	
NRH3010T 150MN	RoHS	15		25	0.550	450	480	
NRH3010T 220MN	RoHS	22		22	0.770	380	410	

● NRH3012 Shielded type

Ordering code	EHS (Environmental Hazardous Substances)	Inductance [μ H]	Inductance Tolerance	Self-resonant frequency [MHz] (min.)	DC Resistance [Ω] ($\pm 20\%$)	Rated current ※) [mA]		Measuring frequency [kHz]
						Saturation current Idc1	Temperature rise current Idc2	
NRH3012T 1R0NN	RoHS	1.0	$\pm 30\%$	111	0.048	2,200	1,710	100
NRH3012T 1R5NN	RoHS	1.5		95	0.055	1,700	1,600	
NRH3012T 2R2MN	RoHS	2.2	$\pm 20\%$	78	0.075	1,500	1,370	
NRH3012T 3R3MN	RoHS	3.3		61	0.100	1,200	1,210	
NRH3012T 4R7MN	RoHS	4.7		50	0.130	1,000	1,060	
NRH3012T 6R8MN	RoHS	6.8		43	0.190	850	890	
NRH3012T 100MN	RoHS	10		32	0.270	730	720	
NRH3012T 150MN	RoHS	15		26	0.450	530	570	
NRH3012T 220MN	RoHS	22		22	0.630	500	500	

※) The saturation current value (Idc1) is the DC current value having inductance decrease down to 30%. (at 20°C)

※) The temperature rise current value (Idc2) is the DC current value having temperature increase up to 40°C. (at 20°C)

※) The rated current is the DC current value that satisfies both of current value saturation current value and temperature rise current value.

* This catalog contains the typical specification only due to the limitation of space. When you consider the purchase of our products, please check our specification. For details of each product (characteristics graph, reliability information, precautions for use, and so on), see our Web site (<http://www.ty-top.com/>) or CD catalogs.

PART NUMBERS

●NRV3012 type

Ordering code	EHS (Environmental Hazardous Substances)	Inductance [μ H]	Inductance Tolerance	Self-resonant frequency [MHz] (min.)	DC Resistance [Ω] ($\pm 20\%$)	Rated current ※) [mA]		Measuring frequency (kHz)
						Saturation current Idc1	Temperature rise current Idc2	
NRV3012T 1R0N	RoHS	1.0	$\pm 30\%$	110	0.065	2,500	1,600	100
NRV3012T 1R5N	RoHS	1.5		92	0.075	2,100	1,400	
NRV3012T 2R2M	RoHS	2.2	$\pm 20\%$	70	0.120	1,800	1,100	
NRV3012T 3R3M	RoHS	3.3		55	0.150	1,600	1,000	
NRV3012T 4R7M	RoHS	4.7		48	0.190	1,250	850	
NRV3012T 6R8M	RoHS	6.8		40	0.300	950	650	
NRV3012T 100M	RoHS	10		32	0.470	800	550	

●NRS4010 Shielded type

Ordering code	EHS (Environmental Hazardous Substances)	Inductance [μ H]	Inductance Tolerance	Self-resonant frequency [MHz] (min.)	DC Resistance [Ω] ($\pm 20\%$)	Rated current ※) [mA]		Measuring frequency (kHz)
						Saturation current Idc1	Temperature rise current Idc2	
NRS4010T 1R0NDGG	RoHS	1.0	$\pm 30\%$	116	0.056	2,000	1,900	100
NRS4010T 2R2MDGG	RoHS	2.2		73	0.085	1,200	1,500	
NRS4010T 3R3MDGG	RoHS	3.3	$\pm 20\%$	58	0.100	1,100	1,400	
NRS4010T 4R7MDGG	RoHS	4.7		47	0.140	950	1,200	
NRS4010T 6R8MDGG	RoHS	6.8		38	0.200	800	1,000	
NRS4010T 100MDGG	RoHS	10		31	0.300	620	750	
NRS4010T 150MDGG	RoHS	15		24	0.430	540	600	
NRS4010T 220MDGG	RoHS	22		19	0.570	450	500	

●NRS4012 Shielded type

Ordering code	EHS (Environmental Hazardous Substances)	Inductance [μ H]	Inductance Tolerance	Self-resonant frequency [MHz] (min.)	DC Resistance [Ω] ($\pm 20\%$)	Rated current ※) [mA]		Measuring frequency (kHz)
						Saturation current Idc1	Temperature rise current Idc2	
NRS4012T 1R0NDGG	RoHS	1.0	$\pm 30\%$	100	0.042	2,800	2,200	100
NRS4012T 2R2MDGJ	RoHS	2.2		70	0.060	1,650	1,900	
NRS4012T 3R3MDGJ	RoHS	3.3	$\pm 20\%$	60	0.070	1,400	1,700	
NRS4012T 4R7MDGJ	RoHS	4.7		45	0.095	1,200	1,500	
NRS4012T 6R8MDGJ	RoHS	6.8		35	0.125	900	1,300	
NRS4012T 100MDGJ	RoHS	10		30	0.170	800	1,100	
NRS4012T 150MDGJ	RoHS	15		24	0.260	650	750	
NRS4012T 220MDGJ	RoHS	22		18	0.400	500	620	

●NRS4018 Shielded type

Ordering code	EHS (Environmental Hazardous Substances)	Inductance [μ H]	Inductance Tolerance	Self-resonant frequency [MHz] (min.)	DC Resistance [Ω] ($\pm 20\%$)	Rated current ※) [mA]		Measuring frequency (kHz)
						Saturation current Idc1	Temperature rise current Idc2	
NRS4018T 1R0NDGJ	RoHS	1.0	$\pm 30\%$	90	0.027	4,000	3,200	100
NRS4018T 2R2MDGJ	RoHS	2.2		60	0.042	3,000	2,200	
NRS4018T 3R3MDGJ	RoHS	3.3	$\pm 20\%$	45	0.055	2,300	2,000	
NRS4018T 4R7MDGJ	RoHS	4.7		35	0.070	2,000	1,700	
NRS4018T 6R8MDGJ	RoHS	6.8		30	0.098	1,600	1,450	
NRS4018T 100MDGJ	RoHS	10		25	0.150	1,300	1,200	
NRS4018T 150MDGJ	RoHS	15		18	0.210	1,100	850	
NRS4018T 220MDGJ	RoHS	22		15	0.290	900	720	
NRS4018T 330MDGJ	RoHS	33		12	0.460	700	550	

●NRS5010 type

Ordering code	EHS (Environmental Hazardous Substances)	Inductance [μ H]	Inductance Tolerance	Self-resonant frequency [MHz] (min.)	DC Resistance [Ω] ($\pm 20\%$)	Rated current ※) [mA]		Measuring frequency (kHz)
						Saturation current Idc1	Temperature rise current Idc2	
NRS5010T 1R0NMGF	RoHS	1.0	$\pm 30\%$	95	0.070	2,350	1,750	100
NRS5010T 2R2NMGF	RoHS	2.2		65	0.105	1,500	1,400	
NRS5010T 3R3MMGF	RoHS	3.3	$\pm 20\%$	42	0.125	1,400	1,250	
NRS5010T 4R7MMGF	RoHS	4.7		37	0.145	1,200	1,150	
NRS5010T 6R8MMGF	RoHS	6.8		33	0.185	1,000	1,000	
NRS5010T 100MMGF	RoHS	10		23	0.250	850	900	
NRS5010T 150MMGF	RoHS	15		19	0.400	680	650	
NRS5010T 220MMGF	RoHS	22		15	0.600	550	450	

●NRS5012 type

Ordering code	EHS (Environmental Hazardous Substances)	Inductance [μ H]	Inductance Tolerance	Self-resonant frequency [MHz] (min.)	DC Resistance [Ω] ($\pm 20\%$)	Rated current ※) [mA]		Measuring frequency (kHz)
						Saturation current Idc1	Temperature rise current Idc2	
NRS5012T 1R0NMGF	RoHS	1.0	$\pm 30\%$	100	0.053	4,500	2,300	100
NRS5012T 1R5NMGF	RoHS	1.5		86	0.070	3,800	2,200	
NRS5012T 2R2MMGF	RoHS	2.2	$\pm 20\%$	70	0.085	3,100	2,000	
NRS5012T 3R3MMGF	RoHS	3.3		48	0.160	2,400	1,450	
NRS5012T 4R7MMGF	RoHS	4.7		40	0.180	2,200	1,400	
NRS5012T 6R8MMGF	RoHS	6.8		36	0.260	1,700	1,100	
NRS5012T 100MMGF	RoHS	10		26	0.420	1,400	850	
NRS5012T 150MMGF	RoHS	15		22	0.670	1,200	640	

※) The saturation current value (Idc1) is the DC current value having inductance decrease down to 30%. (at 20°C)

※) The temperature rise current value (Idc2) is the DC current value having temperature increase up to 40°C. (at 20°C)

※) The rated current is the DC current value that satisfies both of current value saturation current value and temperature rise current value.

* This catalog contains the typical specification only due to the limitation of space. When you consider the purchase of our products, please check our specification. For details of each product (characteristics graph, reliability information, precautions for use, and so on), see our Web site (<http://www.ty-top.com/>) or CD catalogs.

PART NUMBERS

● NRS5014 Shielded type

Ordering code	EHS (Environmental Hazardous Substances)	Inductance [μ H]	Inductance Tolerance	Self-resonant frequency (MHz) (min.)	DC Resistance [Ω] ($\pm 20\%$)	Rated current ※) (mA)		Measuring frequency (kHz)
						Saturation current ldc1	Temperature rise current ldc2	
NRS5014T 1R2NMGG	RoHS	1.2	$\pm 30\%$	86	0.045	3,800	2,400	100
NRS5014T 2R2NMGG	RoHS	2.2		56	0.065	2,800	2,000	
NRS5014T 3R3NMGG	RoHS	3.3		48	0.080	2,350	1,700	
NRS5014T 4R7NMGG	RoHS	4.7	$\pm 20\%$	41	0.100	2,050	1,400	
NRS5014T 6R8MMGG	RoHS	6.8		33	0.150	1600	1,200	
NRS5014T 100MMGG	RoHS	10		27	0.200	1400	1,050	

● NRS5020 Shielded type

Ordering code	EHS (Environmental Hazardous Substances)	Inductance [μ H]	Inductance Tolerance	Self-resonant frequency (MHz) (min.)	DC Resistance [Ω] ($\pm 20\%$)	Rated current ※) (mA)		Measuring frequency (kHz)
						Saturation current ldc1	Temperature rise current ldc2	
NRS5020T 1R0NMGJ	RoHS	1.0	$\pm 30\%$	81	0.021	4,000	3,600	100
NRS5020T 1R5NMGJ	RoHS	1.5		68	0.026	3,350	3,200	
NRS5020T 2R2NMGJ	RoHS	2.2		57	0.035	2,900	2,900	
NRS5020T 3R3NMGJ	RoHS	3.3	$\pm 20\%$	46	0.048	2,400	2,400	
NRS5020T 4R7MMGJ	RoHS	4.7		37	0.060	2,000	2,000	
NRS5020T 6R8MMGJ	RoHS	6.8		30	0.090	1,600	1,650	
NRS5020T 100MMGJ	RoHS	10		24	0.120	1,300	1,450	
NRS5020T 150MMGJ	RoHS	15		20	0.165	1,100	1,200	
NRS5020T 220MMGJ	RoHS	22		17	0.260	900	1,000	

● NRS5024 Shielded type

Ordering code	EHS (Environmental Hazardous Substances)	Inductance [μ H]	Inductance Tolerance	Self-resonant frequency (MHz) (min.)	DC Resistance [Ω] ($\pm 20\%$)	Rated current ※) (mA)		Measuring frequency (kHz)
						Saturation current ldc1	Temperature rise current ldc2	
NRS5024T 1R0NMGJ	RoHS	1.0	$\pm 30\%$	85	0.016	5,800	4,400	100
NRS5024T 1R5NMGJ	RoHS	1.5		67	0.022	5,200	3,600	
NRS5024T 2R2NMGJ	RoHS	2.2		51	0.029	4,100	3,100	
NRS5024T 3R3NMGJ	RoHS	3.3	$\pm 20\%$	41	0.043	3,100	2,400	
NRS5024T 4R7MMGJ	RoHS	4.7		37	0.055	2,700	2,000	
NRS5024T 6R8MMGJ	RoHS	6.8		28	0.080	2,200	1,600	
NRS5024T 100MMGJ	RoHS	10		21	0.125	1,700	1,200	
NRS5024T 150MMGJ	RoHS	15		18	0.170	1,400	1,000	
NRS5024T 220MMGJ	RoHS	22		15	0.230	1,200	820	
NRS5024T 330MMGJ	RoHS	33		11	0.370	1,000	630	

● NRS5040 Shielded type

Ordering code	EHS (Environmental Hazardous Substances)	Inductance [μ H]	Inductance Tolerance	Self-resonant frequency (MHz) (min.)	DC Resistance [Ω] ($\pm 20\%$)	Rated current ※) (mA)		Measuring frequency (kHz)
						Saturation current ldc1	Temperature rise current ldc2	
NRS5040T 1R5NMGJ	RoHS	1.5	$\pm 30\%$	60	0.017	6,400	4,500	100
NRS5040T 2R2NMGJ	RoHS	2.2		42	0.022	5,000	3,700	
NRS5040T 3R3NMGJ	RoHS	3.3		32	0.027	4,000	3,300	
NRS5040T 4R7NMGK	RoHS	4.7	$\pm 20\%$	28	0.029	3,300	3,100	
NRS5040T 6R8MMGJ	RoHS	6.8		21	0.049	2,800	2,400	
NRS5040T 100MMGJ	RoHS	10		18	0.056	2,300	2,100	
NRS5040T 150MMGJ	RoHS	15		13	0.080	2,000	1,800	
NRS5040T 220MMGK	RoHS	22		9	0.126	1,500	1,400	
NRS5040T 330MMGJ	RoHS	33		7	0.180	1,300	1,200	
NRS5040T 470MMGJ	RoHS	47		6	0.310	1,100	900	

● NRS6010 type

Ordering code	EHS (Environmental Hazardous Substances)	Inductance [μ H]	Inductance Tolerance	Self-resonant frequency (MHz) (min.)	DC Resistance [Ω] ($\pm 20\%$)	Rated current ※) (mA)		Measuring frequency (kHz)
						Saturation current ldc1	Temperature rise current ldc2	
NRS6010T 1R5MMGF	RoHS	1.5	$\pm 20\%$	77	0.090	2,400	1,900	100
NRS6010T 2R2MMGF	RoHS	2.2		56	0.110	1,900	1,700	
NRS6010T 3R3MMGF	RoHS	3.3		42	0.135	1,600	1,500	
NRS6010T 4R7MMGF	RoHS	4.7		36	0.165	1,300	1,400	
NRS6010T 6R8MMGF	RoHS	6.8		30	0.220	1,200	1,200	
NRS6010T 100MMGF	RoHS	10		25	0.270	1,000	1,100	
NRS6010T 220MMGF	RoHS	22		12	0.580	650	700	

※) The saturation current value (ldc1) is the DC current value having inductance decrease down to 30%. (at 20°C)
 ※) The temperature rise current value (ldc2) is the DC current value having temperature increase up to 40°C. (at 20°C)
 ※) The rated current is the DC current value that satisfies both of current value saturation current value and temperature rise current value.

* This catalog contains the typical specification only due to the limitation of space. When you consider the purchase of our products, please check our specification. For details of each product (characteristics graph, reliability information, precautions for use, and so on), see our Web site (<http://www.ty-top.com/>) or CD catalogs.

PART NUMBERS

● NRS6012 Shielded type

Ordering code	EHS (Environmental Hazardous Substances)	Inductance [μ H]	Inductance Tolerance	Self-resonant frequency [MHz] (min.)	DC Resistance [Ω] ($\pm 20\%$)	Rated current ※) [mA]		Measuring frequency [kHz]
						Saturation current Idc1	Temperature rise current Idc2	
NRS6012T 2R5NMGG	RoHS	2.5	± 30	45	0.090	2,100	1,800	100
NRS6012T 3R3NMGG	RoHS	3.3		42	0.105	1,800	1,700	
NRS6012T 4R7MMGG	RoHS	4.7		36	0.125	1,600	1,550	
NRS6012T 5R3MMGJ	RoHS	5.3		34	0.125	1,500	1,550	
NRS6012T 6R8MMGJ	RoHS	6.8		30	0.165	1,300	1,350	
NRS6012T 100MMGJ	RoHS	10	± 20	22	0.200	1,000	1,200	
NRS6012T 150MMGJ	RoHS	15		18	0.295	800	800	
NRS6012T 220MMGJ	RoHS	22		12	0.465	760	650	
NRS6012T 330MMGJ	RoHS	33		8	0.580	590	550	
NRS6012T 470MMGJ	RoHS	47		6	0.965	520	460	
NRS6012T 680MMGJ	RoHS	68		3	1.160	440	410	
NRS6012T 101MMGJ	RoHS	100		1	1.670	350	320	

● NRS6014 Shielded type

Ordering code	EHS (Environmental Hazardous Substances)	Inductance [μ H]	Inductance Tolerance	Self-resonant frequency [MHz] (min.)	DC Resistance [Ω] ($\pm 20\%$)	Rated current ※) [mA]		Measuring frequency [kHz]
						Saturation current Idc1	Temperature rise current Idc2	
NRS6014T 1R2NMGG	RoHS	1.2	$\pm 30\%$	77	0.042	4,100	2,750	100
NRS6014T 2R2NMGG	RoHS	2.2		61	0.055	3,000	2,300	
NRS6014T 3R3MMGG	RoHS	3.3		41	0.075	2,500	2,000	
NRS6014T 4R7MMGG	RoHS	4.7	$\pm 20\%$	36	0.090	2,000	1,900	
NRS6014T 6R8MMGG	RoHS	6.8		30	0.115	1,700	1,650	
NRS6014T 100MMGG	RoHS	10		24	0.140	1,400	1,400	
NRS6014T 150MMGG	RoHS	15		20	0.210	1,150	1,200	
NRS6014T 220MMGG	RoHS	22		16	0.300	950	1,000	

● NRS6020 Shielded type

Ordering code	EHS (Environmental Hazardous Substances)	Inductance [μ H]	Inductance Tolerance	Self-resonant frequency [MHz] (min.)	DC Resistance [Ω] ($\pm 20\%$)	Rated current ※) [mA]		Measuring frequency [kHz]
						Saturation current Idc1	Temperature rise current Idc2	
NRS6020T 0R8NMGG	RoHS	0.8	$\pm 30\%$	110	0.020	6,400	4,100	100
NRS6020T 1R5NMGJ	RoHS	1.5		93	0.026	4,300	3,600	
NRS6020T 2R2NMGJ	RoHS	2.2		73	0.034	3,200	2,900	
NRS6020T 3R3NMGJ	RoHS	3.3		55	0.040	2,800	2,750	
NRS6020T 4R7NMGJ	RoHS	4.7		43	0.058	2,400	2,150	
NRS6020T 6R8NMGJ	RoHS	6.8	$\pm 20\%$	30	0.085	2,000	1,800	
NRS6020T 100MMGG	RoHS	10		18	0.125	1,900	1,500	
NRS6020T 220MMGG	RoHS	22		11	0.290	1,250	950	

● NRS6028 Shielded type

Ordering code	EHS (Environmental Hazardous Substances)	Inductance [μ H]	Inductance Tolerance	Self-resonant frequency [MHz] (min.)	DC Resistance [Ω] ($\pm 30\%$)	Rated current ※) [mA]		Measuring frequency [kHz]
						Saturation current Idc1	Temperature rise current Idc2	
NRS6028T 0R9NMGJ	RoHS	0.9	$\pm 30\%$	90	0.013	6,700	4,600	100
NRS6028T 1R5NMGJ	RoHS	1.5		78	0.016	5,100	4,200	
NRS6028T 2R2NMGJ	RoHS	2.2		68	0.020	4,200	3,700	
NRS6028T 3R0NMGJ	RoHS	3.0		55	0.023	3,600	3,400	
NRS6028T 4R7MMGK	RoHS	4.7		39	0.031	2,700	3,000	
NRS6028T 6R0MMGK	RoHS	6.0		30	0.040	2,500	2,500	
NRS6028T 100MMGK	RoHS	10		20	0.065	1,900	1,900	
NRS6028T 150MMGJ	RoHS	15	$\pm 20\%$	17	0.095	1,600	1,800	
NRS6028T 220MMGJ	RoHS	22		12	0.135	1,300	1,400	
NRS6028T 330MMGJ	RoHS	33		10	0.220	1,100	1,100	
NRS6028T 470MMGJ	RoHS	47		8	0.300	1,000	920	
NRS6028T 680MMGJ	RoHS	68		5	0.420	800	770	
NRS6028T 101MMGJ	RoHS	100		3	0.600	650	660	

● NRS6045 Shielded type

Ordering code	EHS (Environmental Hazardous Substances)	Inductance [μ H]	Inductance Tolerance	Self-resonant frequency [MHz] (min.)	DC Resistance [Ω] ($\pm 30\%$)	Rated current ※) [mA]		Measuring frequency [kHz]
						Saturation current Idc1	Temperature rise current Idc2	
NRS6045T 1R0NMGK	RoHS	1.0	$\pm 30\%$	110	0.014	9,800	4,500	100
NRS6045T 1R3NMGK	RoHS	1.3		95	0.016	8,200	4,200	
NRS6045T 1R8NMGK	RoHS	1.8		80	0.019	7,200	3,900	
NRS6045T 2R3NMGK	RoHS	2.3		60	0.022	6,400	3,600	
NRS6045T 3R0NMGK	RoHS	3.0		45	0.024	5,600	3,300	
NRS6045T 4R5MMGK	RoHS	4.5	$\pm 20\%$	25	0.030	4,400	3,100	
NRS6045T 6R3MMGK	RoHS	6.3		15	0.036	3,600	3,000	
NRS6045T 100MMGK	RoHS	10		12	0.046	3,100	2,400	
NRS6045T 150MMGK	RoHS	15		10	0.070	2,500	1,900	
NRS6045T 220MMGK	RoHS	22		7	0.107	2,000	1,600	
NRS6045T 330MMGK	RoHS	33		6	0.141	1,650	1,400	
NRS6045T 470MMGK	RoHS	47		5	0.211	1,400	1,150	
NRS6045T 680MMGK	RoHS	68		4	0.304	1,100	950	
NRS6045T 101MMGK	RoHS	100		3	0.466	900	750	

※) The saturation current value (Idc1) is the DC current value having inductance decrease down to 30%. (at 20°C)

※) The temperature rise current value (Idc2) is the DC current value having temperature increase up to 40°C. (at 20°C)

※) The rated current is the DC current value that satisfies both of current value saturation current value and temperature rise current value.

* This catalog contains the typical specification only due to the limitation of space. When you consider the purchase of our products, please check our specification. For details of each product (characteristics graph, reliability information, precautions for use, and so on), see our Web site (<http://www.ty-top.com/>) or CD catalogs.

PART NUMBERS

● NRS8030 Shielded type

Ordering code	EHS (Environmental Hazardous Substances)	Inductance [μ H]	Inductance Tolerance	Self-resonant frequency [MHz] (min.)	DC Resistance [Ω] ($\pm 30\%$)	Rated current ※) [mA]		Measuring frequency [kHz]
						Saturation current ldc1	Temperature rise current ldc2	
NRS8030T 1R0NJGJ	RoHS	1.0	$\pm 30\%$	120	0.009	7,800	6,200	100
NRS8030T 1R5NJGJ	RoHS	1.5		80	0.012	6,200	5,300	
NRS8030T 2R2NJGJ	RoHS	2.2		60	0.015	4,900	4,800	
NRS8030T 3R3MJGJ	RoHS	3.3		50	0.019	4,200	4,300	
NRS8030T 4R7MJGJ	RoHS	4.7		40	0.022	3,600	4,000	
NRS8030T 6R8MJGJ	RoHS	6.8	$\pm 20\%$	32	0.029	3,000	3,400	
NRS8030T 100MJGJ	RoHS	10		27	0.033	2,400	3,000	
NRS8030T 150MJGJ	RoHS	15		20	0.060	2,000	2,200	
NRS8030T 220MJGJ	RoHS	22		16	0.070	1,750	1,900	
NRS8030T 330MJGJ	RoHS	33		13	0.120	1,300	1,500	
NRS8030T 470MJGJ	RoHS	47		11	0.170	1,100	1,300	

● NRS8040 Shielded type

Ordering code	EHS (Environmental Hazardous Substances)	Inductance [μ H]	Inductance Tolerance	Self-resonant frequency [MHz] (min.)	DC Resistance [Ω] ($\pm 30\%$)	Rated current ※) [mA]		Measuring frequency [kHz]
						Saturation current ldc1	Temperature rise current ldc2	
NRS8040T 0R9NJGJ	RoHS	0.9	$\pm 30\%$	85	0.006	13,000	7,800	100
NRS8040T 1R4NJGJ	RoHS	1.4		63	0.007	10,000	7,000	
NRS8040T 2R0NJGJ	RoHS	2.0		50	0.009	8,100	6,300	
NRS8040T 3R6NJGJ	RoHS	3.6		34	0.015	6,400	4,900	
NRS8040T 4R7NJGJ	RoHS	4.7		30	0.018	5,400	4,100	
NRS8040T 6R8NJGJ	RoHS	6.8	$\pm 20\%$	24	0.025	4,400	3,700	
NRS8040T 100MJGJ	RoHS	10		22	0.034	3,800	3,100	
NRS8040T 150MJGJ	RoHS	15		16	0.050	2,900	2,400	
NRS8040T 220MJGJ	RoHS	22		13	0.066	2,400	2,200	

● NR 3010 Shielded type

Ordering code	EHS (Environmental Hazardous Substances)	Inductance [μ H]	Inductance Tolerance	Self-resonant frequency [MHz] (min.)	DC Resistance [Ω] ($\pm 20\%$)	Rated current ※) [mA]		Measuring frequency [kHz]
						Saturation current ldc1	Temperature rise current ldc2	
NR 3010T 1R0N	RoHS	1.0	$\pm 30\%$	126	0.065	1,300	1,400	100
NR 3010T 1R5N	RoHS	1.5		98	0.080	1,200	1,300	
NR 3010T 2R2M	RoHS	2.2		82	0.095	1,100	1,100	
NR 3010T 3R3M	RoHS	3.3		63	0.140	870	940	
NR 3010T 4R7M	RoHS	4.7		56	0.190	750	780	
NR 3010T 6R8M	RoHS	6.8	$\pm 20\%$	46	0.300	610	630	
NR 3010T 100M	RoHS	10		35	0.450	500	510	
NR 3010T 150M	RoHS	15		30	0.740	400	400	
NR 3010T 220M	RoHS	22		25	1.03	350	350	
NR 3010T 330M	RoHS	33		20	1.55	260	275	
NR 3010T 470M	RoHS	47		17	2.05	220	235	

● NR 3012 Shielded type

Ordering code	EHS (Environmental Hazardous Substances)	Inductance [μ H]	Inductance Tolerance	Self-resonant frequency [MHz] (min.)	DC Resistance [Ω] ($\pm 20\%$)	Rated current ※) [mA]		Measuring frequency [kHz]
						Saturation current ldc1	Temperature rise current ldc2	
NR 3012T 1R0N	RoHS	1.0	$\pm 30\%$	110	0.050	1,500	1,490	100
NR 3012T 1R5N	RoHS	1.5		92	0.060	1,360	1,400	
NR 3012T 2R2M	RoHS	2.2		70	0.080	1,100	1,200	
NR 3012T 3R3M	RoHS	3.3		55	0.100	910	1,050	
NR 3012T 4R7M	RoHS	4.7		48	0.130	770	980	
NR 3012T 6R8M	RoHS	6.8	$\pm 20\%$	40	0.190	670	740	
NR 3012T 100M	RoHS	10		32	0.290	540	630	
NR 3012T 150M	RoHS	15		27	0.450	440	485	
NR 3012T 220M	RoHS	22		22	0.630	375	420	
NR 3012T 330M	RoHS	33		19	1.03	310	330	
NR 3012T 470M	RoHS	47		17	1.45	250	280	

● NR 3015 Shielded type

Ordering code	EHS (Environmental Hazardous Substances)	Inductance [μ H]	Inductance Tolerance	Self-resonant frequency [MHz] (min.)	DC Resistance [Ω] ($\pm 20\%$)	Rated current ※) [mA]		Measuring frequency [kHz]
						Saturation current ldc1	Temperature rise current ldc2	
NR 3015T 1R0N	RoHS	1.0	$\pm 30\%$	100	0.030	2,100	2,100	100
NR 3015T 1R5N	RoHS	1.5		87	0.040	1,800	1,820	
NR 3015T 2R2M	RoHS	2.2		64	0.060	1,480	1,500	
NR 3015T 3R3M	RoHS	3.3		49	0.080	1,210	1,230	
NR 3015T 4R7M	RoHS	4.7		40	0.120	1,020	1,040	
NR 3015T 6R8M	RoHS	6.8	$\pm 20\%$	36	0.160	870	880	
NR 3015T 100M	RoHS	10		28	0.230	700	710	
NR 3015T 150M	RoHS	15		23	0.360	560	560	
NR 3015T 220M	RoHS	22		20	0.520	470	470	
NR 3015T 330M	RoHS	33		18	0.840	390	370	
NR 3015T 470M	RoHS	47		17	1.34	320	300	

※) The saturation current value (ldc1) is the DC current value having inductance decrease down to 30%. (at 20°C)

※) The temperature rise current value (ldc2) is the DC current value having temperature increase up to 40°C. (at 20°C)

※) The rated current is the DC current value that satisfies both of current value saturation current value and temperature rise current value.

* This catalog contains the typical specification only due to the limitation of space. When you consider the purchase of our products, please check our specification. For details of each product (characteristics graph, reliability information, precautions for use, and so on), see our Web site (<http://www.ty-top.com/>) or CD catalogs.

PART NUMBERS

● NR 4010 Shielded type

Ordering code	EHS (Environmental Hazardous Substances)	Inductance [μ H]	Inductance Tolerance	Self-resonant frequency [MHz] (min.)	DC Resistance [Ω] ($\pm 20\%$)	Rated current ※) [mA]		Measuring frequency [kHz]
						Saturation current Idc1	Temperature rise current Idc2	
NR 4010T 1R0N	RoHS	1.0	$\pm 30\%$	116	0.100	1,800	1,050	100
NR 4010T 2R2N	RoHS	2.2		73	0.150	1,150	890	
NR 4010T 3R3M	RoHS	3.3		58	0.180	1,100	820	
NR 4010T 4R7M	RoHS	4.7	$\pm 20\%$	47	0.210	900	750	
NR 4010T 6R8M	RoHS	6.8		38	0.300	740	620	
NR 4010T 100M	RoHS	10		31	0.380	560	600	
NR 4010T 150M	RoHS	15		24	0.510	470	510	
NR 4010T 220M	RoHS	22		19	0.870	360	400	
NR 4010T 330M	RoHS	33		15	1.54	280	300	
NR 4010T 470M	RoHS	47		13	1.81	240	280	

● NR 4012 Shielded type

Ordering code	EHS (Environmental Hazardous Substances)	Inductance [μ H]	Inductance Tolerance	Self-resonant frequency [MHz] (min.)	DC Resistance [Ω] ($\pm 20\%$)	Rated current ※) [mA]		Measuring frequency [kHz]
						Saturation current Idc1	Temperature rise current Idc2	
NR 4012T 1R0N	RoHS	1.0	$\pm 30\%$	131	0.060	2,500	1,500	100
NR 4012T 2R2M	RoHS	2.2		66	0.090	1,650	1,200	
NR 4012T 3R3M	RoHS	3.3		50	0.130	1,200	980	
NR 4012T 4R7M	RoHS	4.7	$\pm 20\%$	45	0.140	1,050	960	
NR 4012T 6R8M	RoHS	6.8		35	0.180	900	840	
NR 4012T 100M	RoHS	10		28	0.240	740	770	
NR 4012T 150M	RoHS	15		23	0.400	560	600	
NR 4012T 220M	RoHS	22		18	0.480	510	540	
NR 4012T 330M	RoHS	33		15	0.810	400	420	
NR 4012T 470M	RoHS	47		12	1.00	350	370	

● NR 4018 Shielded type

Ordering code	EHS (Environmental Hazardous Substances)	Inductance [μ H]	Inductance Tolerance	Self-resonant frequency [MHz] (min.)	DC Resistance [Ω] ($\pm 20\%$)	Rated current ※) [mA]		Measuring frequency [kHz]
						Saturation current Idc1	Temperature rise current Idc2	
NR 4018T 1R0N	RoHS	1.0	$\pm 30\%$	80	0.030	4,000	1,830	100
NR 4018T 2R2M	RoHS	2.2		52	0.060	2,700	1,440	
NR 4018T 3R3M	RoHS	3.3		44	0.070	2,000	1,230	
NR 4018T 4R7M	RoHS	4.7	$\pm 20\%$	34	0.090	1,700	1,200	
NR 4018T 6R8M	RoHS	6.8		29	0.110	1,450	1,060	
NR 4018T 100M	RoHS	10		24	0.180	1,200	840	
NR 4018T 150M	RoHS	15		19	0.250	940	650	
NR 4018T 220M	RoHS	22		16	0.360	800	590	
NR 4018T 330M	RoHS	33		12	0.530	650	490	
NR 4018T 470M	RoHS	47		10	0.650	570	420	
NR 4018T 680M	RoHS	68		8.3	1.00	470	320	
NR 4018T 101M	RoHS	100		6.5	1.50	400	270	
NR 4018T 151M	RoHS	150		5.5	2.50	310	220	
NR 4018T 221M	RoHS	220	4.0	4.00	270	170		

● NR 5040 Shielded type

Ordering code	EHS (Environmental Hazardous Substances)	Inductance [μ H]	Inductance Tolerance	Self-resonant frequency [MHz] (min.)	DC Resistance [Ω] ($\pm 30\%$)	Rated current ※) [mA]		Measuring frequency [kHz]
						Saturation current Idc1	Temperature rise current Idc2	
NR 5040T 1R5N	RoHS	1.5	$\pm 30\%$	60	0.020	6,000	3,600	100
NR 5040T 2R2N	RoHS	2.2		42	0.022	4,600	3,500	
NR 5040T 3R3N	RoHS	3.3		32	0.027	3,800	3,300	
NR 5040T 4R7N	RoHS	4.7	$\pm 20\%$	28	0.029	3,300	3,100	
NR 5040T 6R8M	RoHS	6.8		21	0.049	2,600	2,300	
NR 5040T 100M	RoHS	10		18	0.056	2,300	2,100	
NR 5040T 150M	RoHS	15		13	0.080	2,000	1,800	
NR 5040T 220M	RoHS	22		9	0.126	1,600	1,400	
NR 5040T 330M	RoHS	33		7	0.180	1,300	1,200	
NR 5040T 470M	RoHS	47		6	0.310	1,100	900	

● NR 6012 Shielded type

Ordering code	EHS (Environmental Hazardous Substances)	Inductance [μ H]	Inductance Tolerance	Self-resonant frequency [MHz] (min.)	DC Resistance [Ω] ($\pm 20\%$)	Rated current ※) [mA]		Measuring frequency [kHz]
						Saturation current Idc1	Temperature rise current Idc2	
NR 6012T 2R5NE	RoHS	2.5	$\pm 30\%$	45	0.090	2,100	1,730	100
NR 6012T 4R0NE	RoHS	4.0		39	0.105	1,800	1,570	
NR 6012T 5R3ME	RoHS	5.3		34	0.125	1,500	1,400	
NR 6012T 6R8ME	RoHS	6.8	$\pm 20\%$	30	0.165	1,300	1,180	
NR 6012T 100ME	RoHS	10		22	0.235	1,000	1,000	
NR 6012T 150ME	RoHS	15		18	0.330	800	790	
NR 6012T 220ME	RoHS	22		12	0.530	760	630	
NR 6012T 330ME	RoHS	33		8	0.700	590	530	
NR 6012T 470ME	RoHS	47		6	1.05	520	460	
NR 6012T 680ME	RoHS	68		3	1.35	440	410	
NR 6012T 101ME	RoHS	100	1	2.18	350	320		

※) The saturation current value (Idc1) is the DC current value having inductance decrease down to 30%. (at 20°C)

※) The temperature rise current value (Idc2) is the DC current value having temperature increase up to 40°C. (at 20°C)

※) The rated current is the DC current value that satisfies both of current value saturation current value and temperature rise current value.

* This catalog contains the typical specification only due to the limitation of space. When you consider the purchase of our products, please check our specification. For details of each product (characteristics graph, reliability information, precautions for use, and so on), see our Web site (<http://www.ty-top.com/>) or CD catalogs.

PART NUMBERS

● NR 6020 Shielded type

Ordering code	EHS (Environmental Hazardous Substances)	Inductance [μ H]	Inductance Tolerance	Self-resonant frequency [MHz] (min.)	DC Resistance [Ω] ($\pm 20\%$)	Rated current ※) [mA]		Measuring frequency [kHz]
						Saturation current Idc1	Temperature rise current Idc2	
NR 6020T 0R8N	RoHS	0.8	$\pm 30\%$	110	0.020	5,500	3,800	100
NR 6020T 1R5N	RoHS	1.5		93	0.026	4,000	3,200	
NR 6020T 2R2N	RoHS	2.2		73	0.034	3,200	2,700	
NR 6020T 3R3N	RoHS	3.3		55	0.040	2,800	2,600	
NR 6020T 4R7N	RoHS	4.7		43	0.058	2,400	2,000	
NR 6020T 6R8N	RoHS	6.8	$\pm 20\%$	30	0.085	2,000	1,800	
NR 6020T 100M	RoHS	10		18	0.125	1,700	1,400	
NR 6020T 220M	RoHS	22		11	0.290	1,050	950	

● NR 6028 Shielded type

Ordering code	EHS (Environmental Hazardous Substances)	Inductance [μ H]	Inductance Tolerance	Self-resonant frequency [MHz] (min.)	DC Resistance [Ω] ($\pm 30\%$)	Rated current ※) [mA]		Measuring frequency [kHz]
						Saturation current Idc1	Temperature rise current Idc2	
NR 6028T 0R9N	RoHS	0.9	$\pm 30\%$	90	0.013	6,600	4,600	100
NR 6028T 1R5N	RoHS	1.5		78	0.016	5,000	4,200	
NR 6028T 2R2N	RoHS	2.2		68	0.020	4,200	3,700	
NR 6028T 3R0N	RoHS	3.0		55	0.023	3,600	3,400	
NR 6028T 4R7M	RoHS	4.7		39	0.031	2,700	3,000	
NR 6028T 6R0M	RoHS	6.0	$\pm 20\%$	30	0.040	2,500	2,500	
NR 6028T 100M	RoHS	10		20	0.065	1,900	1,900	
NR 6028T 150M	RoHS	15		17	0.095	1,600	1,800	
NR 6028T 220M	RoHS	22		12	0.135	1,300	1,400	
NR 6028T 330M	RoHS	33		10	0.220	1,100	1,100	
NR 6028T 470M	RoHS	47		8	0.300	950	920	
NR 6028T 680M	RoHS	68		5	0.420	760	770	
NR 6028T 101M	RoHS	100		3	0.600	620	660	

● NR 6045 Shielded type

Ordering code	EHS (Environmental Hazardous Substances)	Inductance [μ H]	Inductance Tolerance	Self-resonant frequency [MHz] (min.)	DC Resistance [Ω] ($\pm 30\%$)	Rated current ※) [mA]		Measuring frequency [kHz]
						Saturation current Idc1	Temperature rise current Idc2	
NR 6045T 1R0N	RoHS	1.0	$\pm 30\%$	110	0.014	8,500	4,200	100
NR 6045T 1R3N	RoHS	1.3		95	0.016	8,000	4,000	
NR 6045T 1R8N	RoHS	1.8		80	0.018	7,000	3,700	
NR 6045T 2R3N	RoHS	2.3		60	0.021	6,000	3,500	
NR 6045T 3R0N	RoHS	3.0		45	0.024	5,000	3,200	
NR 6045T 4R5M	RoHS	4.5	$\pm 20\%$	25	0.031	4,000	3,000	
NR 6045T 6R3M	RoHS	6.3		15	0.038	3,800	2,800	
NR 6045T 100M	RoHS	10		12	0.047	3,000	2,500	
NR 6045T 150M	RoHS	15		10	0.077	2,300	1,900	
NR 6045T 220M	RoHS	22		7	0.115	1,900	1,500	
NR 6045T 330M	RoHS	33		6	0.145	1,500	1,400	
NR 6045T 470M	RoHS	47		5	0.220	1,300	1,100	
NR 6045T 680M	RoHS	68		4	0.330	1,000	900	
NR 6045T 101M	RoHS	100		3	0.500	800	700	

● NR 8040 Shielded type

Ordering code	EHS (Environmental Hazardous Substances)	Inductance [μ H]	Inductance Tolerance	Self-resonant frequency [MHz] (min.)	DC Resistance [Ω] ($\pm 30\%$)	Rated current ※) [mA]		Measuring frequency [kHz]
						Saturation current Idc1	Temperature rise current Idc2	
NR 8040T 0R9N	RoHS	0.9	$\pm 30\%$	85	0.006	11,000	7,800	100
NR 8040T 1R4N	RoHS	1.4		63	0.007	9,000	7,000	
NR 8040T 2R0N	RoHS	2.0		50	0.009	7,400	6,300	
NR 8040T 3R6N	RoHS	3.6		34	0.015	5,300	4,900	
NR 8040T 4R7N	RoHS	4.7		30	0.018	4,700	4,100	
NR 8040T 6R8N	RoHS	6.8	$\pm 20\%$	24	0.025	4,000	3,700	
NR 8040T 100M	RoHS	10		22	0.034	3,400	3,100	
NR 8040T 150M	RoHS	15		16	0.050	2,700	2,400	
NR 8040T 220M	RoHS	22		13	0.066	2,200	2,200	
NR 8040T 330M	RoHS	33		12	0.100	1,900	1,700	
NR 8040T 470M	RoHS	47		8	0.150	1,500	1,400	
NR 8040T 680M	RoHS	68		7	0.230	1,200	1,100	
NR 8040T 101M	RoHS	100		6	0.290	1,000	1,000	

※) The saturation current value (Idc1) is the DC current value having inductance decrease down to 30%. (at 20°C)

※) The temperature rise current value (Idc2) is the DC current value having temperature increase up to 40°C. (at 20°C)

※) The rated current is the DC current value that satisfies both of current value saturation current value and temperature rise current value.

* This catalog contains the typical specification only due to the limitation of space. When you consider the purchase of our products, please check our specification. For details of each product (characteristics graph, reliability information, precautions for use, and so on), see our Web site (<http://www.ty-top.com/>) or CD catalogs.

DC Bias characteristics

(Measured by HP4285A)



* This catalog contains the typical specification only due to the limitation of space. When you consider the purchase of our products, please check our specification. For details of each product (characteristics graph, reliability information, precautions for use, and so on), see our Web site (<http://www.ty-top.com/>) or CD catalogs.

DC Bias characteristics

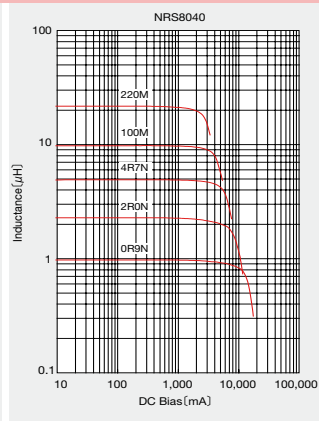
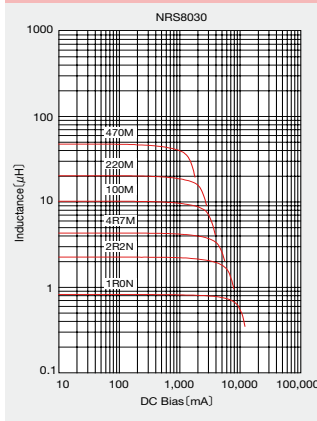
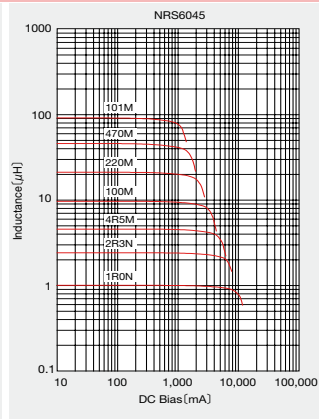
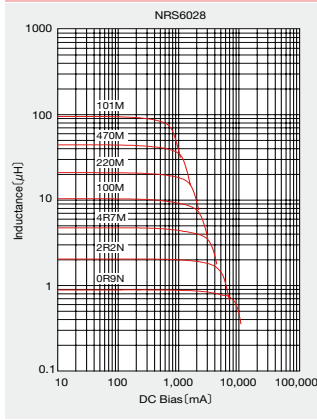
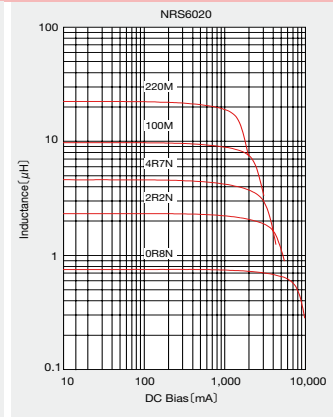
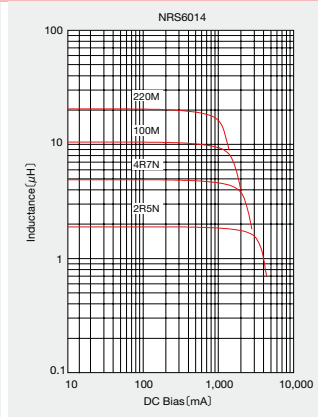
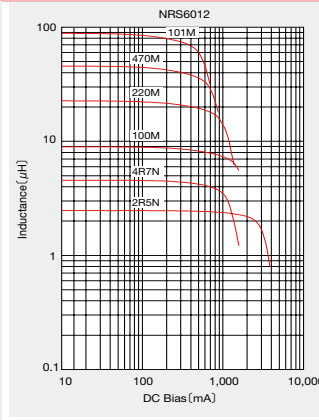
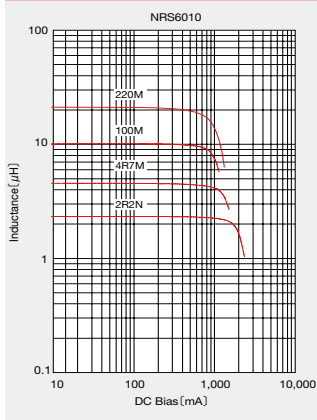
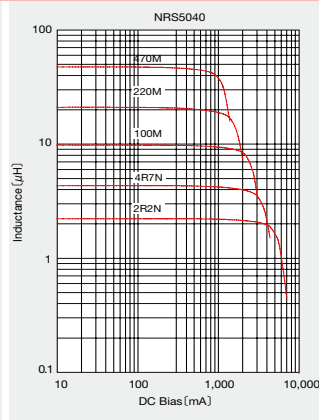
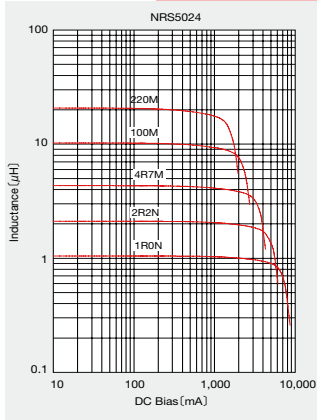

* This catalog contains the typical specification only due to the limitation of space. When you consider the purchase of our products, please check our specification. For details of each product (characteristics graph, reliability information, precautions for use, and so on), see our Web site (<http://www.ty-top.com/>) or CD catalogs.

DC Bias characteristics

(Measured by HP4285A)



* This catalog contains the typical specification only due to the limitation of space. When you consider the purchase of our products, please check our specification. For details of each product (characteristics graph, reliability information, precautions for use, and so on), see our Web site (<http://www.ty-top.com/>) or CD catalogs.

① Minimum Quantity

Type	Standard Quantity [pcs]	
	Tape & Reel	
NRS2012/NRV2012	2500	
NRH2410	2500	
NRH2412	2500	
NR 3010/NRH3010	2000	
NR 3012/NRH3012/NRV3012	2000	
NR 3015	2000	
NR 4010/NRS4010	5000	
NR 4012/NRS4012	4500	
NR 4018/NRS4018	3500	
NRS5010	1000	
NRS5012	1000	
NRS5014	1000	
NRS5020	800	
NRS5024	2500	
NR 5040/NRS5040	1500	
NRS6010	1000	
NR 6012/NRS6012	1000	
NRS6014	1000	
NR 6020/NRS6020	2500	
NR 6028/NRS6028	2000	
NR 6045/NRS6045	1500	
NRS8030	1000	
NR 8040/NRS8040	1000	

② Tape Material

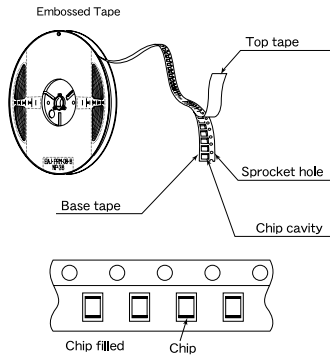

③ Taping dimensions

● Embossed tape 8mm wide (0.315 inches wide)

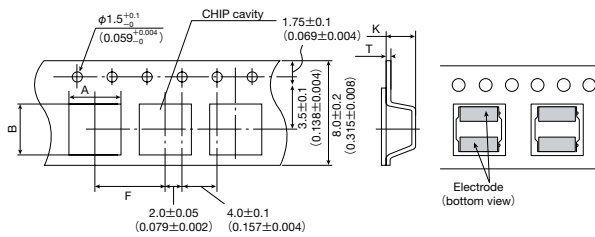

Type	Chip cavity		Insertion pitch F	Tape thickness	
	A	B		T	K
NRS2012	2.2±0.1	2.2±0.1	4.0±0.1 (0.157±0.004)	0.25±0.05	1.3±0.1
NRV2012	(0.102±0.004)	(0.102±0.004)		(0.009±0.002)	(0.051±0.004)
NRH2410	2.6±0.1	2.6±0.1		0.25±0.05	1.3±0.1
NRH2412	(0.087±0.004)	(0.102±0.004)		(0.009±0.002)	(0.051±0.004)
NR 3010	3.2±0.1	3.2±0.1	4.0±0.1 (0.157±0.004)	1.4±0.1	1.4±0.1
NRH3010				(0.055±0.004)	(0.055±0.004)
NR 3012				0.3±0.05	1.6±0.1
NRH3012	(0.012±0.002)	(0.063±0.004)	(0.063±0.004)		
NRV3012	(0.126±0.004)	(0.126±0.004)		1.9±0.1	1.9±0.1
NR 3015				(0.075±0.004)	(0.075±0.004)

Unit : mm (inch)

● Embossed tape 12mm wide (0.47 inches wide)

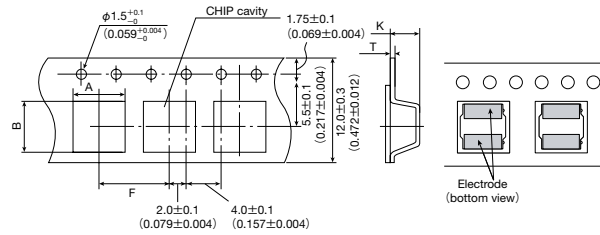

Type	Chip cavity		Insertion pitch F	Tape thickness		
	A	B		T	K	
NR 4010	4.3±0.1	4.3±0.1	8.0±0.1 (0.315±0.004)	0.3±0.1	1.4±0.1	
NRS4010				(0.012±0.004)	(0.055±0.004)	
NR 4012				1.6±0.1	1.6±0.1	
NRS4012				(0.063±0.004)	(0.063±0.004)	
NR 4018	5.25±0.1	5.25±0.1	8.0±0.1 (0.315±0.004)	2.1±0.1	2.1±0.1	
NRS4018				(0.083±0.004)	(0.083±0.004)	
NRS5010	1.4±0.1	1.4±0.1				
NRS5012	(0.055±0.004)	(0.055±0.004)				
NRS5014	1.6±0.1	1.6±0.1				
NRS5014	(0.063±0.004)	(0.063±0.004)				
NRS5020	2.3±0.1	2.3±0.1				
NRS5020	(0.091±0.004)	(0.091±0.004)				
NRS5024	2.7±0.1	2.7±0.1				
NRS5024	(0.106±0.004)	(0.106±0.004)				
NR 5040	5.15±0.1	5.15±0.1	0.4±0.1 (0.016±0.004)	4.2±0.1	4.2±0.1	
NRS5040	(0.203±0.004)	(0.203±0.004)		(0.165±0.004)	(0.165±0.004)	
NRS6010	6.3±0.1	6.3±0.1		1.4±0.1	1.4±0.1	
NR 6012				(0.055±0.004)	(0.055±0.004)	
NRS6012				1.6±0.1	1.6±0.1	
NRS6012				(0.063±0.004)	(0.063±0.004)	
NRS6014	1.6±0.1	1.6±0.1		0.4±0.1 (0.016±0.004)	2.3±0.1	2.3±0.1
NR 6020	(0.063±0.004)	(0.063±0.004)			(0.090±0.004)	(0.090±0.004)
NRS6020	2.3±0.1	2.3±0.1				
NR 6028	3.1±0.1	3.1±0.1				
NRS6028	(0.122±0.004)	(0.122±0.004)				
NR 6045	4.7±0.1	4.7±0.1				
NRS6045	(0.185±0.004)	(0.185±0.004)				

Unit : mm (inch)

● Embossed tape 16mm wide (0.63 inches wide)

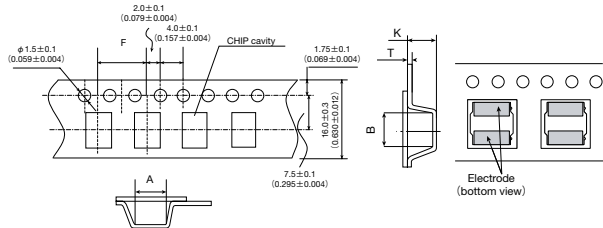

Type	Chip cavity		Insertion pitch F	Tape thickness	
	A	B		T	K
NRS8030	8.3±0.1	8.3±0.1	12.0±0.1	0.5±0.1	3.4±0.1
NR 8040	(0.327±0.004)	(0.327±0.004)	(0.472±0.004)	(0.020±0.004)	(0.134±0.004)
NRS8040					4.5±0.1
					(0.177±0.004)

Unit : mm (inch)

④ Leader and Blank portion

● NR, NRH, NRS, NRV

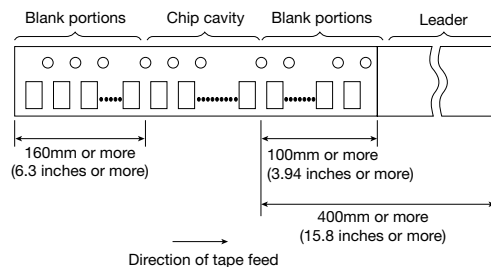

* This catalog contains the typical specification only due to the limitation of space. When you consider the purchase of our products, please check our specification. For details of each product (characteristics graph, reliability information, precautions for use, and so on), see our Web site (<http://www.ty-top.com/>) or CD catalogs.

⑤ Reel size

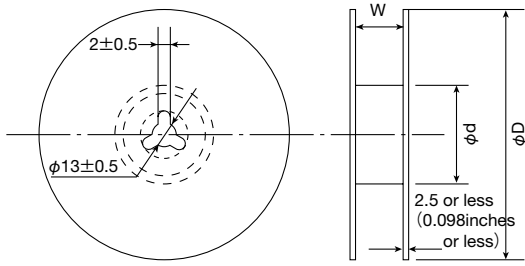

Type	Reel size (Reference values)		
	φD	φd	W
NRS2012	180±0.5 (7.087±0.019)	60±1.0 (2.36±0.04)	10.0±1.5 (0.394±0.059)
NRV2012			
NRH2410			
NRH2412			
NR 3010			
NRH3010			
NR 3012	180±3.0 (7.087±0.118)	60±2.0 (2.36±0.08)	14.0±1.5 (0.551±0.059)
NRH3012			
NRV3012			
NR 3015			
NRS5010			
NRS5012			
NRS5014	180±3.0 (7.087±0.118)	60±2.0 (2.36±0.08)	14.0±1.5 (0.551±0.059)
NRS5020			
NRS6010			
NR 6012			
NRS6012			
NRS6014			

Unit : mm (inch)

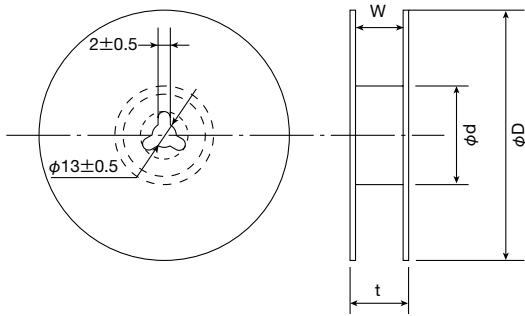

Type	Reel size (Reference values)			
	φD	φd	t (max.)	W
NR 4010	330±3.0 (12.99±0.118)	80±2.0 (3.15±0.078)	18.5 (0.72)	13.5±1.0 (0.531±0.04)
NRS4010				
NR 4012				
NRS4012				
NR 4018				
NRS4018				
NRS5024				
NR 5040				
NRS5040				
NR 6020				
NRS6020				
NR 6028				
NRS6028				
NR 6045				
NRS6045				
NRS8030			22.5 (0.89)	17.5±1.0 (0.689±0.04)
NR 8040				
NRS8040			22.5 (0.89)	17.5±1.0 (0.689±0.04)
NRS8040				

Unit : mm (inch)

⑥ Top Tape Strength

The top tape requires a peel-off force of 0.1 to 1.3N in the direction of the arrow as illustrated below.

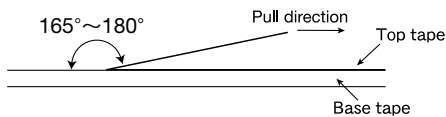

* This catalog contains the typical specification only due to the limitation of space. When you consider the purchase of our products, please check our specification. For details of each product (characteristics graph, reliability information, precautions for use, and so on), see our Web site (<http://www.ty-top.com/>) or CD catalogs.

RELIABILITY DATA

SMD inductor (NR□, NS series)

1. Operating Temperature Range	
NR30/40/50/60/80, NRS20, NRV20/30, NRH24/30 Type	-25~+120°C
NRS40/50/60/80 Type	-25~+125°C
NR10050 Type	-25~+105°C
NS101, NS125Type	-40~+125°C

[Test Method and Remarks]
Including self-generated heat

2. Storage Temperature Range	
NR30/40/50/60/80, NRV20/30, NRH24/30, NRS20/40/50/60/80 Type	-40~+85°C
NR10050 Type	
NS101, NS125Type	

[Test Method and Remarks]
NR30/40/50/60/80, NRV20/30, NRH24/30, NRS20/40/50/60/80Type, NR10050 Type, NS101/125 Type : -5 to 40°C for the product with taping.

3. Rated current	
NR30/40/50/60/80, NRV20/30, NRH24/30, NRS20/40/50/60/80 Type	Within the specified tolerance
NR10050 Type	
NS101, NS125Type	

4. Inductance	
NR30/40/50/60/80, NRV20/30, NRH24/30, NRS20/40/50/60/80 Type	Within the specified tolerance
NR10050 Type	
NS101, NS125Type	

[Test Method and Remarks]
LCR Meter : HP 4285A or equivalent, Measuring frequency : Specified frequency
NR30/40/50/60/80, NRV20/30, NRH24/30, NRS20/40/50/60/80Type, NS101/125 Type : LCR Meter : HP 4285A or equivalent, 100kHz, 1V
NR10050 Type : LCR Meter : HP 4263A or equivalent, 100kHz, 1V

5. DC Resistance	
NR30/40/50/60/80, NRV20/30, NRH24/30, NRS20/40/50/60/80 Type	Within the specified tolerance
NR10050 Type	
NS101, NS125Type	

[Test Method and Remarks]
DC ohmmeter : HIOKI 3227 or equivalent

6. Self resonance frequency	
NR30/40/50/60/80, NRV30, NRH24/30, NRS40/50/60/80 Type	Within the specification
NR10050 Type	
NS101, NS125Type	

[Test Method and Remarks]
NR30/40/50/60/80, NRV30, NRH24/30, NRS40/50/60/80Type, NR10050 Type, NS101/125 Type :
Impedance analyzer/material analyzer : HP4291A or equivalent HP4191A, 4192A or equivalent

7. Temperature characteristic	
NR30/40/50/60/80, NRV20/30, NRH24/30, NRS20/40/50/60/80 Type	Inductance change : Within ±20%
NR10050 Type	
NS101, NS125Type	Inductance change : Within ±15%

[Test Method and Remarks]
NR30/40/50/60/80, NRV20/30, NRH24/30, NRS20/40/50/60/80 Type, NR10050 Type : Measurement of inductance shall be taken at temperature range within -25°C~+85°C. With reference to inductance value at +20°C., change rate shall be calculated.
NS101, NS125 Type : Measurement of inductance shall be taken at temperature range within -40°C~+125°C. With reference to inductance value at +20°C., change rate shall be calculated.
Change of maximum inductance deviation in step 1 to 5

Temperature at step 1	20°C
Temperature at step 2	Minimum operating temperature
Temperature at step 3	20°C (Standard temperature)
Temperature at step 4	Maximum operating temperature
Temperature at step 5	20°C

8. Resistance to flexure of substrate	
NR30/40/50/60/80, NRV20/30, NRH24/30, NRS20/40/50/60/80 Type	No damage
NR10050 Type	
NS101, NS125Type	No damage

[Test Method and Remarks]
NR30/40/50/60/80, NRV20/30, NRH24/30, NRS20/40/50/60/80 Type, NS101/125Type :

The test samples shall be soldered to the test board by the reflow. As illustrated below, apply force in the direction of the arrow indicating until deflection of the test board reaches to 2 mm.

Test board size : 100×40×1.0
Test board material : glass epoxy-resin
Solder cream thickness : 0.10 (NR30, NRS20, NRH24/30, NRV20/30)
0.15 (NR40/50/60/80, NRS40/50/60, NS101/125Type)

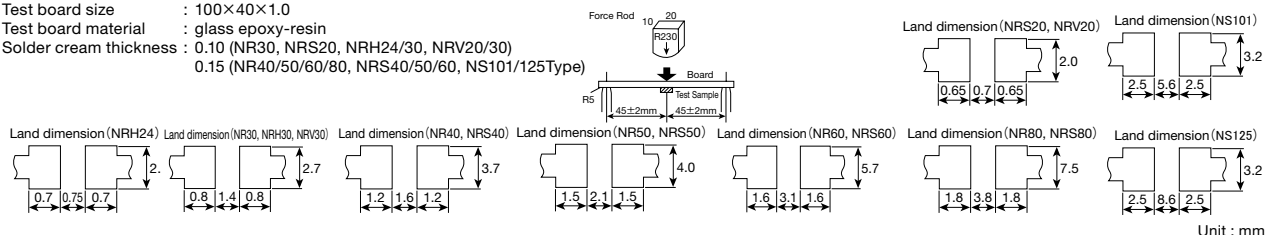

Unit : mm

* This catalog contains the typical specification only due to the limitation of space. When you consider the purchase of our products, please check our specification. For details of each product (characteristics graph, reliability information, precautions for use, and so on), see our Web site (<http://www.ty-top.com/>) or CD catalogs.

RELIABILITY DATA

SMD inductor (NR□, NS series)

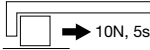
9. Insulation resistance : between wires															
NR30/40/50/60/80, NRV20/30, NRH24/30, NRS20/40/50/60/80 Type															
NR10050 Type															
NS101, NS125Type															
10. Insulation resistance : between wire and core															
NR30/40/50/60/80, NRV20/30, NRH24/30, NRS20/40/50/60/80 Type															
NR10050 Type															
NS101, NS125Type															
11. Withstanding voltage : between wire and core															
NR30/40/50/60/80, NRV20/30, NRH24/30, NRS20/40/50/60/80 Type															
NR10050 Type															
NS101, NS125Type															
12. Adhesion of terminal electrode															
NR30/40/50/60/80, NRV20/30, NRH24/30, NRS20/40/50/60/80 Type	Shall not come off PC board														
NR10050 Type															
NS101, NS125Type															
[Test Method and Remarks] NR30/40/50/60/80, NRV20/30, NRH24/30, NRS20/40/50/60/80Type, NS101/125 Type : The test samples shall be soldered to the test board by the reflow. •Applied force : 10N to X and Y directions. •Duration : 5s. •Solder cream thickness : 0.15mm. 															
NR10050 Type : •Applied force : 5N to X and Y directions. •Duration : 5s.															
13. Resistance to vibration															
NR30/40/50/60/80, NRV20/30, NRH24/30, NRS20/40/50/60/80 Type	Inductance change : Within $\pm 10\%$ No significant abnormality in appearance.														
NR10050 Type															
NS101, NS125Type															
[Test Method and Remarks] NR30/40/50/60/80, NRV20/30, NRH24/30, NRS20/40/50/60/80Type, NR10050 Type, NS101/125 Type : The test samples shall be soldered to the test board by the reflow. Then it shall be submitted to below test conditions. <table border="1" data-bbox="180 1043 727 1185"> <tr> <td>Frequency Range</td> <td colspan="2">10~55Hz</td> </tr> <tr> <td>Total Amplitude</td> <td colspan="2">1.5mm (May not exceed acceleration 196m/s²)</td> </tr> <tr> <td>Sweeping Method</td> <td colspan="2">10Hz to 55Hz to 10Hz for 1min.</td> </tr> <tr> <td rowspan="3">Time</td> <td>X</td> <td rowspan="3">For 2 hours on each X, Y, and Z axis.</td> </tr> <tr> <td>Y</td> </tr> <tr> <td>Z</td> </tr> </table>		Frequency Range	10~55Hz		Total Amplitude	1.5mm (May not exceed acceleration 196m/s ²)		Sweeping Method	10Hz to 55Hz to 10Hz for 1min.		Time	X	For 2 hours on each X, Y, and Z axis.	Y	Z
Frequency Range	10~55Hz														
Total Amplitude	1.5mm (May not exceed acceleration 196m/s ²)														
Sweeping Method	10Hz to 55Hz to 10Hz for 1min.														
Time	X	For 2 hours on each X, Y, and Z axis.													
	Y														
	Z														
Recovery : At least 2hrs of recovery under the standard condition after the test, followed by the measurement within 48hrs.															
14. Solderability															
NR30/40/50/60/80, NRV20/30, NRH24/30, NRS20/40/50/60/80 Type	At least 90% of surface of terminal electrode is covered by new solder.														
NR10050 Type															
NS101, NS125Type															
[Test Method and Remarks] The test samples shall be dipped in flux, and then immersed in molten solder as shown in below table. Flux : Methanol solution containing rosin 25%. <table border="1" data-bbox="180 1443 469 1493"> <tr> <td>Solder Temperature</td> <td>245\pm5$^{\circ}$C</td> </tr> <tr> <td>Time</td> <td>5\pm1.0 sec.</td> </tr> </table>		Solder Temperature	245 \pm 5 $^{\circ}$ C	Time	5 \pm 1.0 sec.										
Solder Temperature	245 \pm 5 $^{\circ}$ C														
Time	5 \pm 1.0 sec.														
NR30/40/50/60/80, NRV20/30, NRH24/30, NRS20/40/50/60/80 Type, NR10050 Type, NS101/125 Type : ※Immersion depth : All sides of mounting terminal shall be immersed.															
15. Resistance to soldering heat															
NR30/40/50/60/80, NRV20/30, NRH24/30, NRS20/40/50/60/80 Type	Inductance change : Within $\pm 10\%$ No significant abnormality in appearance.														
NR10050 Type															
NS101, NS125Type															
[Test Method and Remarks] NR30/40/50/60/80, NRV20/30, NRH24/30, NRS20/40/50/60/80Type, NR10050 Type, NS101/125 Type : The test sample shall be exposed to reflow oven at 230 \pm 5 $^{\circ}$ C for 40 seconds, with peak temperature at 260 \pm 5 $^{\circ}$ C for 5 seconds, 2 times. <table border="1" data-bbox="153 1731 1027 1771"> <tr> <td>Test board thickness : 1.0mm (NR30/40/50/60/80, NRV20/30, NRH24/30, NRS20/40/50/60/80Type, NS101/125 Type)</td> </tr> <tr> <td>1.6mm (NR10050 Type)</td> </tr> <tr> <td>Test board material : glass epoxy-resin</td> </tr> </table>		Test board thickness : 1.0mm (NR30/40/50/60/80, NRV20/30, NRH24/30, NRS20/40/50/60/80Type, NS101/125 Type)	1.6mm (NR10050 Type)	Test board material : glass epoxy-resin											
Test board thickness : 1.0mm (NR30/40/50/60/80, NRV20/30, NRH24/30, NRS20/40/50/60/80Type, NS101/125 Type)															
1.6mm (NR10050 Type)															
Test board material : glass epoxy-resin															

* This catalog contains the typical specification only due to the limitation of space. When you consider the purchase of our products, please check our specification. For details of each product (characteristics graph, reliability information, precautions for use, and so on), see our Web site (<http://www.ty-top.com/>) or CD catalogs.

RELIABILITY DATA

SMD inductor (NR□, NS series)

16. Thermal shock

NR30/40/50/60/80, NRV20/30, NRH24/30, NRS20/40/50/60/80 Type	Inductance change : Within $\pm 10\%$ No significant abnormality in appearance.
NR10050 Type	
NS101, NS125Type	

[Test Method and Remarks]

NR30/40/50/60/80, NRV20/30, NRH24/30, NRS20/40/50/60/80Type, NR10050 Type, NS101/125 Type :

The test samples shall be soldered to the test board by the reflow. The test samples shall be placed at specified temperature for specified time by step 1 to step 4 as shown in below table in sequence. The temperature cycle shall be repeated 100 cycles.

Conditions of 1 cycle		
Step	Temperature (°C)	Duration (min)
1	-40 ± 3	30 ± 3
2	Room temperature	Within 3
3	$+85 \pm 2$	30 ± 3
4	Room temperature	Within 3

17. Damp heat

NR30/40/50/60/80, NRV20/30, NRH24/30, NRS20/40/50/60/80 Type	Inductance change : Within $\pm 10\%$ No significant abnormality in appearance.
NR10050 Type	
NS101, NS125Type	Inductance change : Within $\pm 10\%$ No significant abnormality in appearance.

[Test Method and Remarks]

NR30/40/50/60/80, NRV20/30, NRH24/30, NRS20/40/50/60/80Type, NS101/125Type :

The test samples shall be soldered to the test board by the reflow.

The test samples shall be placed in thermostatic oven set at specified temperature and humidity as shown in below table.

Temperature	$60 \pm 2^\circ\text{C}$
Humidity	90~95%RH
Time	500+24/-0 hour

18. Loading under damp heat

NR30/40/50/60/80, NRV20/30, NRH24/30, NRS20/40/50/60/80 Type	Inductance change : Within $\pm 10\%$ No significant abnormality in appearance.
NR10050 Type	
NS101, NS125Type	

[Test Method and Remarks]

NR30/40/50/60/80, NRV20/30, NRH24/30, NRS20/40/50/60/80Type, NR10050 Type, NS101/125Type :

The test samples shall be soldered to the test board by the reflow.

The test samples shall be placed in thermostatic oven set at specified temperature and humidity and applied the rated current continuously as shown in below table.

Temperature	$60 \pm 2^\circ\text{C}$
Humidity	90~95%RH
Applied current	Rated current
Time	500+24/-0 hour

19. Low temperature life test

NR30/40/50/60/80, NRV20/30, NRH24/30, NRS20/40/50/60/80 Type	Inductance change : Within $\pm 10\%$ No significant abnormality in appearance.
NR10050 Type	
NS101, NS125Type	

[Test Method and Remarks]

NR30/40/50/60/80, NRV20/30, NRH24/30, NRS20/40/50/60/80Type, NR10050 Type, NS101/125Type :

The test samples shall be soldered to the test board by the reflow. After that, the test samples shall be placed at test conditions as shown in below table.

Temperature	$-40 \pm 2^\circ\text{C}$
Time	500+24/-0 hour

20. High temperature life test

NR30/40/50/60/80, NRV20/30, NRH24/30, NRS20/40/50/60/80 Type	Inductance change : Within $\pm 10\%$ No significant abnormality in appearance.
NR10050 Type	
NS101, NS125Type	

[Test Method and Remarks]

NR10050 Type :

Temperature	$105 \pm 3^\circ\text{C}$
Time	500+24/-0 hour

Recovery : At least 2hrs of recovery under the standard condition after the test, followed by the measurement within 48hrs.

21. Loading at high temperature life test

NR30/40/50/60/80, NRV20/30, NRH24/30, NRS20/40/50/60/80 Type	Inductance change : Within $\pm 10\%$ No significant abnormality in appearance.
NR10050 Type	
NS101, NS125Type	Inductance change : Within $\pm 10\%$ No significant abnormality in appearance.

[Test Method and Remarks]

NR30/40/50/60/80, NRV20/30, NRH24/30, NRS20/40/50/60/80Type, NS101/125 Type :

The test samples shall be soldered to the test board by the reflow soldering.

Temperature	$85 \pm 2^\circ\text{C}$
Applied current	Rated current
Time	500+24/-0 hour

22. Standard condition

NR30/40/50/60/80, NRV20/30, NRH24/30, NRS20/40/50/60/80 Type	Standard test condition : Unless otherwise specified, temperature is $20 \pm 15^\circ\text{C}$ and $65 \pm 20\%$ of relative humidity. When there is any question concerning measurement result: In order to provide correlation data, the test shall be condition of $20 \pm 2^\circ\text{C}$ of temperature, $65 \pm 5\%$ relative humidity. Inductance is in accordance with our measured value.
NR10050 Type	
NS101, NS125Type	

* This catalog contains the typical specification only due to the limitation of space. When you consider the purchase of our products, please check our specification. For details of each product (characteristics graph, reliability information, precautions for use, and so on), see our Web site (<http://www.ty-top.com/>) or CD catalogs.

PRECAUTIONS

SMD inductor (NR□, NS series)

1. Circuit Design	
Precautions	<ul style="list-style-type: none"> ◆ Operating environment <ol style="list-style-type: none"> 1. The products described in this specification are intended for use in general electronic equipment, (office supply equipment, telecommunications systems, measuring equipment, and household equipment). They are not intended for use in mission-critical equipment or systems requiring special quality and high reliability (traffic systems, safety equipment, aerospace systems, nuclear control systems and medical equipment including life-support systems,) where product failure might result in loss of life, injury or damage. For such uses, contact TAIYO YUDEN Sales Department in advance.
2. PCB Design	
Precautions	<ul style="list-style-type: none"> ◆ Land pattern design <ol style="list-style-type: none"> 1. Please refer to a recommended land pattern.
Technical considerations	<ul style="list-style-type: none"> ◆ Land pattern design <ul style="list-style-type: none"> Surface Mounting • Mounting and soldering conditions should be checked beforehand. • Applicable soldering process to this products is reflow soldering only.
3. Considerations for automatic placement	
Precautions	<ul style="list-style-type: none"> ◆ Adjustment of mounting machine <ol style="list-style-type: none"> 1. Excessive impact load should not be imposed on the products when mounting onto the PC boards. 2. Mounting and soldering conditions should be checked beforehand.
Technical considerations	<ul style="list-style-type: none"> ◆ Adjustment of mounting machine <ol style="list-style-type: none"> 1. When installing products, care should be taken not to apply distortion stress as it may deform the products.
4. Soldering	
Precautions	<ul style="list-style-type: none"> ◆ Reflow soldering <ol style="list-style-type: none"> 1. Please contact any of our offices for a reflow soldering, and refer to the recommended condition specified. 2. The product shall be used reflow soldering only. 3. Please do not add any stress to a product until it returns in normal temperature after reflow soldering. ◆ Lead free soldering <ol style="list-style-type: none"> 1. When using products with lead free soldering, we request to use them after confirming adhesion, temperature of resistance to soldering heat, soldering etc sufficiently. ◆ Recommended conditions for using a soldering iron (NR10050 Type) <ul style="list-style-type: none"> • Put the soldering iron on the land-pattern. • Soldering iron's temperature - Below 350°C • Duration - 3 seconds or less • The soldering iron should not directly touch the inductor.
Technical considerations	<ul style="list-style-type: none"> ◆ Reflow soldering <ol style="list-style-type: none"> 1. If products are used beyond the range of the recommended conditions, heat stresses may deform the products, and consequently degrade the reliability of the products. <ul style="list-style-type: none"> • NR30/40/50/60/80, NRV20/30, NRH24/30, NRS20/40/50/60/80 Type, NR10050 Type, NS101/125 Type Recommended reflow condition (Pb free solder)
5. Cleaning	
Precautions	<ul style="list-style-type: none"> ◆ Cleaning conditions <ol style="list-style-type: none"> 1. Washing by supersonic waves shall be avoided.
Technical considerations	<ul style="list-style-type: none"> ◆ Cleaning conditions <ol style="list-style-type: none"> 1. if washed by supersonic waves, the products might be broken.
6. Handling	
Precautions	<ul style="list-style-type: none"> ◆ Handling <ol style="list-style-type: none"> 1. Keep the product away from all magnets and magnetic objects. ◆ Breakaway PC boards (splitting along perforations) <ol style="list-style-type: none"> 1. When splitting the PC board after mounting product, care should be taken not to give any stresses of deflection or twisting to the board. 2. Board separation should not be done manually, but by using the appropriate devices. ◆ Mechanical considerations <ol style="list-style-type: none"> 1. Please do not give the product any excessive mechanical shocks. 2. Please do not add any shock and power to a product in transportation. ◆ Pick-up pressure <ol style="list-style-type: none"> 1. Please do not push to add any pressure to a winding part. Please do not give any shock and push into a ferrite core exposure part. ◆ Packing <ol style="list-style-type: none"> 1. Please avoid accumulation of a packing box as much as possible.
Technical considerations	<ul style="list-style-type: none"> ◆ Breakaway PC boards (splitting along perforations) <ol style="list-style-type: none"> 1. The position of the product on PCBs shall be carefully considered to minimize the stress caused from splitting of the PCBs. ◆ Mechanical considerations <ol style="list-style-type: none"> 1. There is a case to be damaged by a mechanical shock. 2. There is a case to be broken by the handling in transportation. ◆ Pick-up pressure <ol style="list-style-type: none"> 1. Damage and a characteristic can vary with an excessive shock or stress. ◆ Packing <ol style="list-style-type: none"> 1. If packing boxes are accumulated, that could cause a deformation on packing tapes or a damage on the products.
7. Storage conditions	
Precautions	<ul style="list-style-type: none"> ◆ Storage <ol style="list-style-type: none"> 1. To maintain the solderability of terminal electrodes and to keep the packing material in good condition, temperature and humidity in the storage area should be controlled. <ul style="list-style-type: none"> • Recommended conditions Ambient temperature: -5~40°C Humidity : Below 70% RH <p>The ambient temperature must be kept below 30°C. Even under ideal storage conditions, solderability of products electrodes may decrease as time passes. For this reason, product should be used within 6 months from the time of delivery. In case of storage over 6 months, solderability shall be checked before actual usage.</p>
Technical considerations	<ul style="list-style-type: none"> ◆ Storage <ol style="list-style-type: none"> 1. Under a high temperature and humidity environment, problems such as reduced solderability caused by oxidation of terminal electrodes and deterioration of taping/packaging materials may take place.

* This catalog contains the typical specification only due to the limitation of space. When you consider the purchase of our products, please check our specification. For details of each product (characteristics graph, reliability information, precautions for use, and so on), see our Web site (<http://www.ty-top.com/>) or CD catalogs.