

Low power quad voltage comparators

Features

- Wide single supply voltage range or dual supplies:
+2V to +36V or $\pm 1V$ to $\pm 18V$
- Very low supply current : 0.8mA typ. at $V_{CC}^+ = 5V$
- Low input bias current: 20nA typ.
- Low input offset current: 0.5nA typ.
- Low input offset voltage: 0.5mV typ.
- Input common-mode voltage range includes ground
- Low output saturation voltage: 160mV typ. at $I_{sink} = 4mA$
- Differential input voltage range equal to the supply voltage
- TTL, DTL, ECL, MOS, CMOS compatible outputs
- Internal ESD protection
Human body model (HBM) $\pm 2000V$ typ.

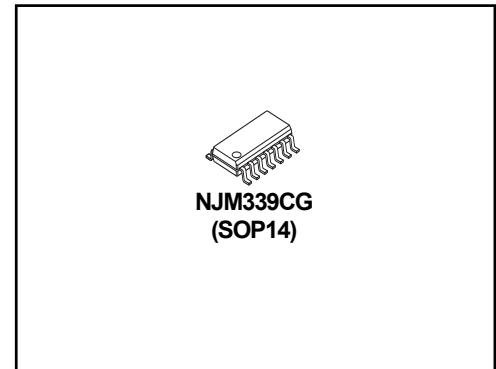

Description

The NJM339 consist of four independent low power voltage comparators designed specifically to operate from a single supply over a wide range of voltages. Operation from split power supplies is also possible.

These comparators also have a unique characteristic in that the input common-mode voltage range includes ground even though operated from a single power supply voltage.

1 Pin and schematic diagram

Figure 1. Pin connections (top view)

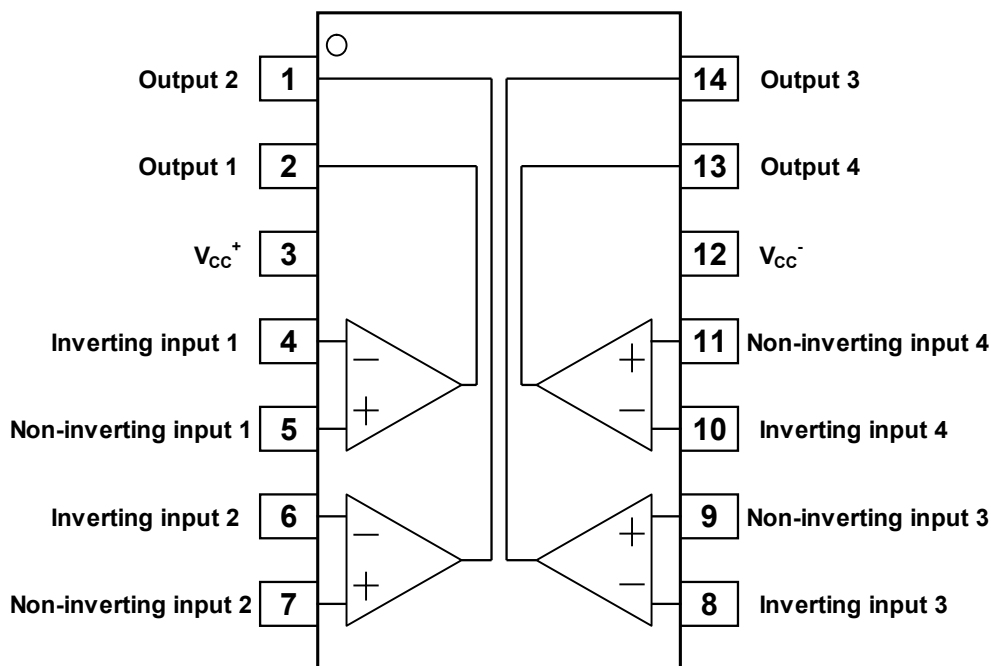
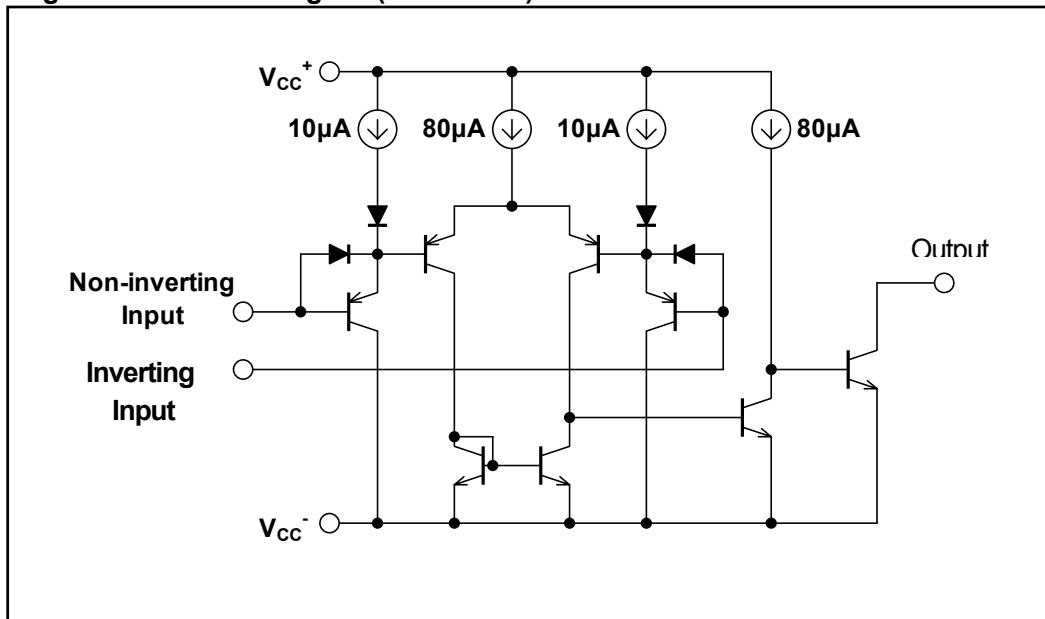

Figure 2. Schematic diagram (1/4 NJM339)



2 Absolute maximum ratings and operating conditions

Table 1. Absolute maximum ratings (Tamb=25°C)

Symbol	Parameter	Value	Unit
V _{CC}	Supply voltage(V _{CC} ⁺ - V _{CC} ⁻)	36	V
V _{ID}	Differential input voltage	±36	V
V _{IN}	Input voltage ⁽¹⁾	- 0.3 to +36	V
-	Output short-circuit to V _{CC} ⁻ ⁽²⁾	Infinite	-
T _j	Maximum junction temperature	150	°C
T _{stg}	Storage temperature range	-65 to +150	°C
P _D	Power Dissipation	880 ⁽⁴⁾ 1200 ⁽⁵⁾	mW
θ _{ja}	thermal resistance junction to ambient ⁽³⁾	140 ⁽⁴⁾ 100 ⁽⁵⁾	°C/W
ψ _{jt}	thermal resistance junction to top surface of IC package ⁽³⁾	40 ⁽⁴⁾ 35 ⁽⁵⁾	°C/W

1. Input voltage is the voltage should be allowed to apply to the input terminal independent of the magnitude of V_{CC}⁺.
2. Short-circuits from the output to V_{CC}⁺ can cause excessive heating and potential destruction
3. Short-circuit can cause excessive heating and destructive dissipation. Values are typical.
4. EIA/JEDEC STANDARD Test board (76.2 x 114.3 x 1.6mm, 4layers, FR-4) mounting
5. EIA/JEDEC STANDARD Test board (76.2 x 114.3 x 1.6mm, 2layers, FR-4) mounting

Table2. Operating conditions (T_{amb}=25°C)

Symbol	Parameter	Value	Unit
V _{CC}	Supply voltage (V _{CC} ⁺ - V _{CC} ⁻)	2 to 36	V
V _{icm}	Common mode input voltage range (V _{CC} ⁺ =30V) T _{amb} T _{min} ≤ T _{amb} ≤ T _{max}	0 to V _{CC} ⁺ -1.5 0 to V _{CC} ⁺ -2.0	V
T _{oper}	Operating free-air temperature range	-40 to +85	°C

3 Electrical characteristics

Table3. V_{CC}⁺ = +5V, V_{CC}⁻ = 0V, T_{amb} = +25°C, T_{min} = 0°C, T_{max} = 70°C (unless otherwise specified)

Symbol	Parameter	NJM339C			Unit
		Min.	Typ.	Max.	
V _{io}	Input offset voltage ⁽¹⁾ T _{amb}	-	0.5	5	mV
	T _{min} ≤ T _{amb} ≤ T _{max} ⁽⁵⁾	-	-	9	
I _{io}	Input offset current T _{amb}	-	0.5	50	nA
	T _{min} ≤ T _{amb} ≤ T _{max} ⁽⁵⁾	-	-	150	
I _{ib}	Input bias current ⁽²⁾ T _{amb}	-	20	250	nA
	T _{min} ≤ T _{amb} ≤ T _{max} ⁽⁵⁾	-	-	400	
A _{vd}	Large signal voltage gain T _{amb} , V _{CC} ⁺ = 15V, R _L = 15kΩ, V _o = 1V to 11V	50	200	-	V/mV
I _{CC}	Supply current (all comparators) T _{amb} , V _{CC} ⁺ = +5V, no load	-	0.8	2	mA
	T _{amb} , V _{CC} ⁺ = +30V, no load	-	1.1	2.5	
V _{id}	Differential input voltage ⁽³⁾ T _{amb}	-	-	V _{CC} ⁺	V
V _{OL}	Low level output voltage T _{amb} , V _{id} = -1V, I _{sink} = 4mA	-	160	400	mV
	T _{min} ≤ T _{amb} ≤ T _{max} ⁽⁵⁾	-	-	700	
I _{OH}	High level output current (V _{id} = 1V) T _{amb} , V _{CC} ⁺ = V _o = 30V	-	0.1	-	nA μA
	T _{min} ≤ T _{amb} ≤ T _{max} ⁽⁵⁾	-	-	1	
I _{sink}	Output sink current V _{id} = 1V, V _o = 1.5V, T _{amb} ,	6	16	-	mA
t _{re}	Response Time ⁽⁴⁾ T _{amb} , R _L = 5.1kΩ connected to V _{CC} ⁺	-	1.3	-	μs
t _{rel}	Large Signal Response Time T _{amb} , R _L = 5.1kΩ connected to V _{CC} ⁺ e _i = TTL, V _(ref) = +1.4V	-	250	-	ns

1. V_o = 1.4V, R_S = 0Ω, 5V < V_{CC}⁺ < 30V, 0 < V_{ic} < (V_{CC}⁺ - 1.5V.)

2. The direction of the input current is out of the IC due to the PNP input stage.

3. Positive excursions of input voltage may exceed the power supply level. As long as the other voltage remains within the common-mode range, the comparator will provide a proper output state. The low input voltage must not be less than -0.3V (or 0.3V below the negative power supply, if used).

4. The response time specified is for a 100mV input step with 5mV overdrive.

5. This parameter is not 100% test.

■ TYPICAL CHARACTERISTICS

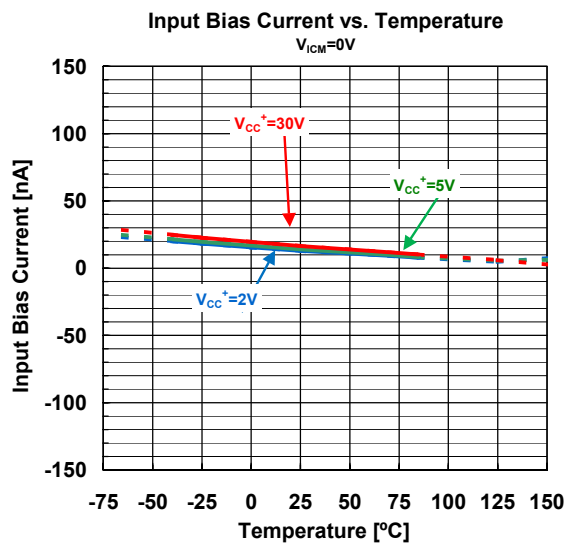
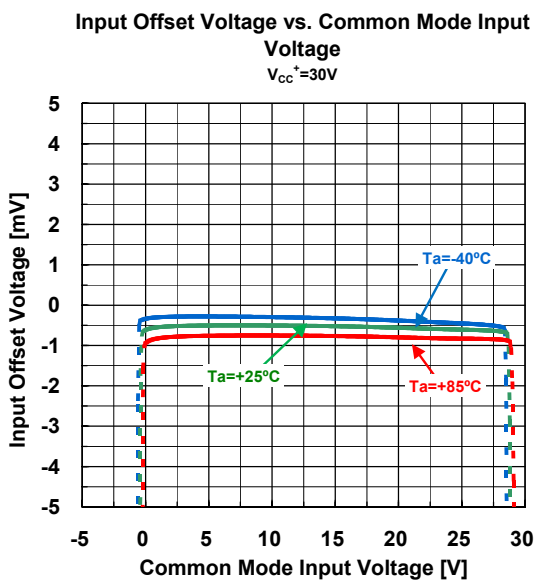
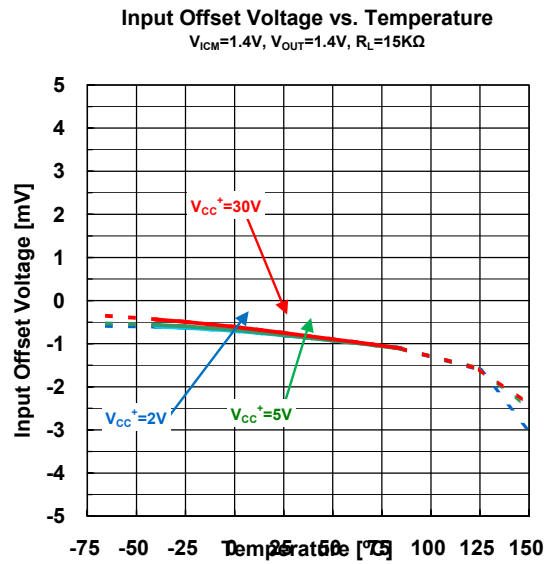
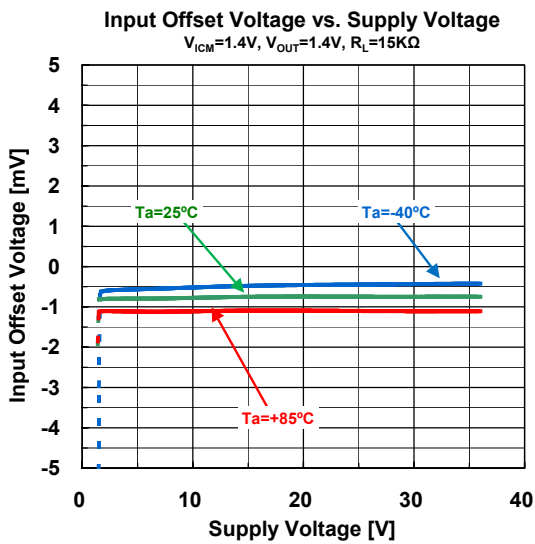
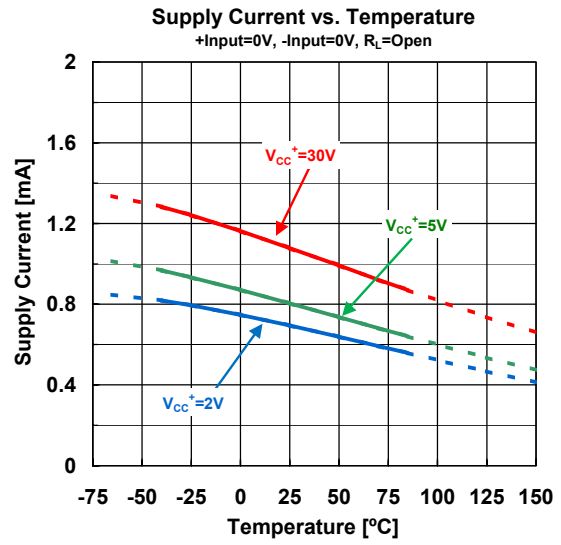
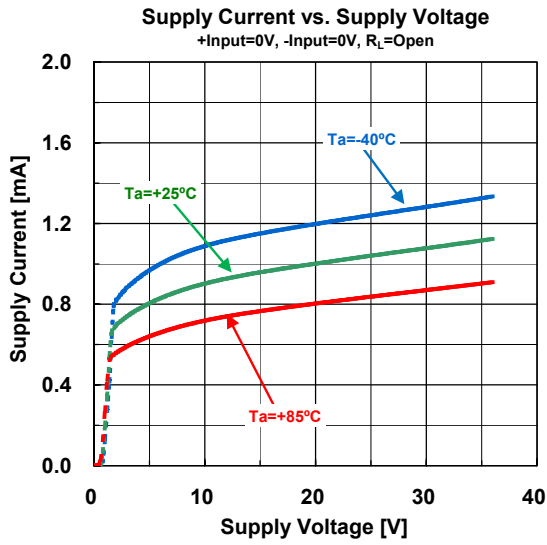

Open Loop Gain vs. Temperature

$V_{CC}^+=15V, V_{OUT}=1V$ to $11V$

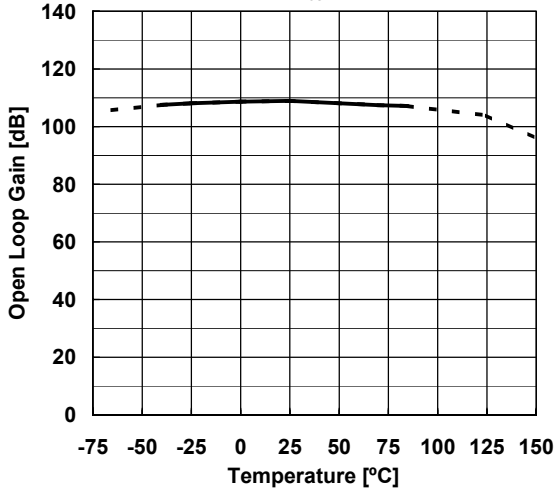

Sink Current vs. Temperature

$V_{OUT}=1.5V, +Input=0V, -Input=1V$

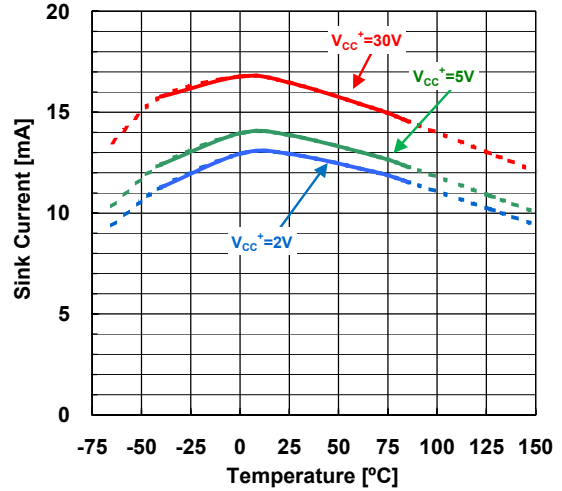

Saturation Voltage vs. Sink Current

$V_{CC}^+=5V, +Input=0V, -Input=1V$

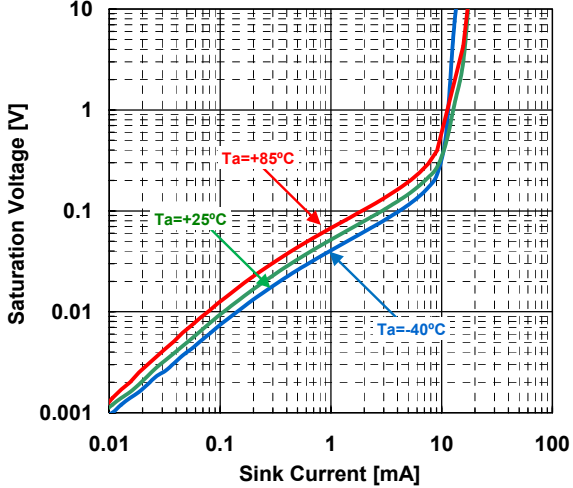

Saturation Voltage vs. Temperature

$V_{CC}^+=5V, +Input=0V, -Input=1V, I_{OUT}=3mA$

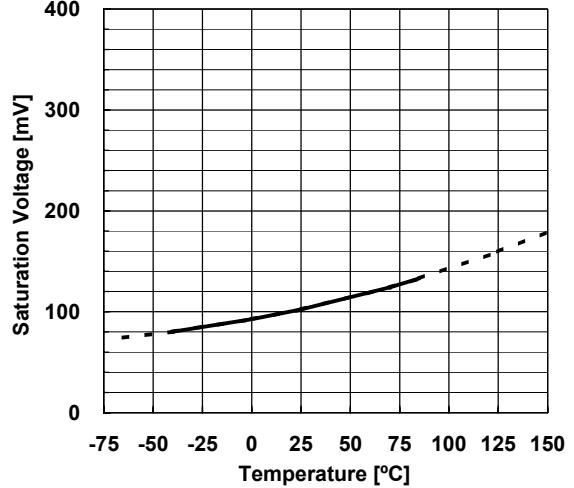

Propagation Delay Time vs. Temperature

$V_{CC}^+=5V, V_{IN+}=GND, V_{IN-}=200mV_{PP}, ov=100mV, R_L=5.1k\Omega$

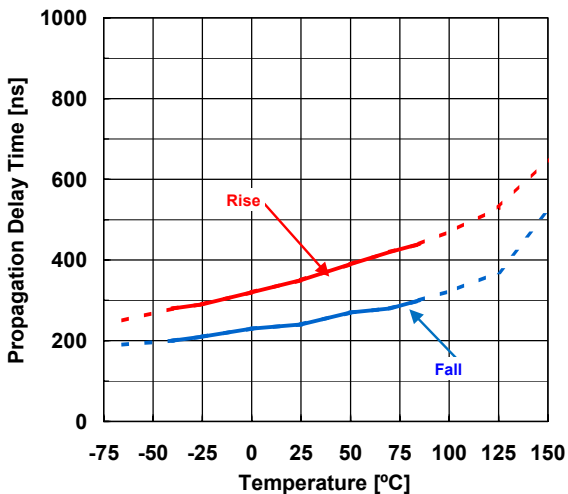

Response Time vs. Temperature

$V_{CC}^+=5V, V_{IN+}=GND, V_{IN-}=200mV_{PP}, ov=100mV, R_L=5.1k\Omega$

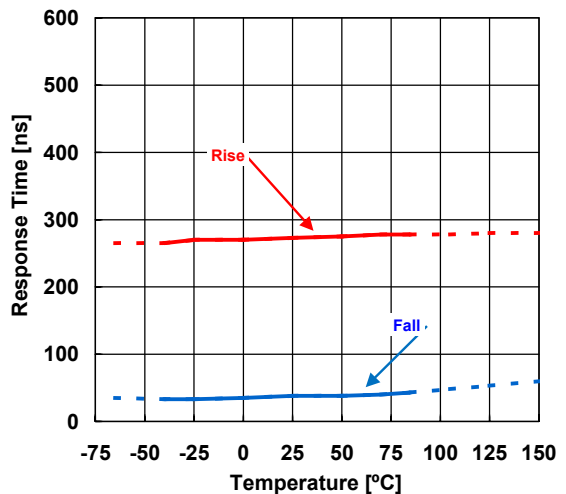

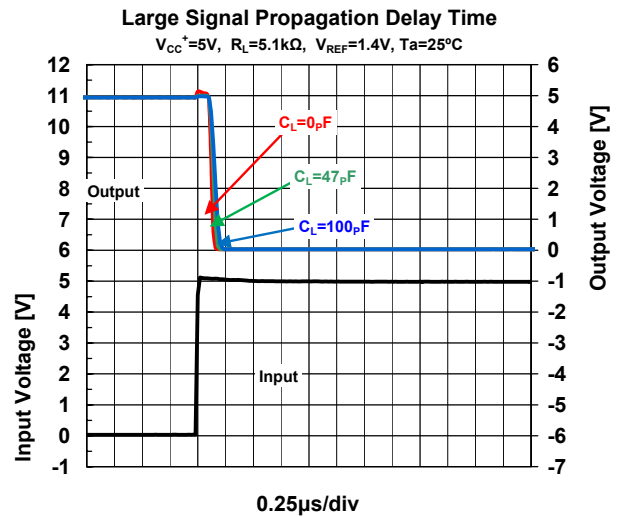
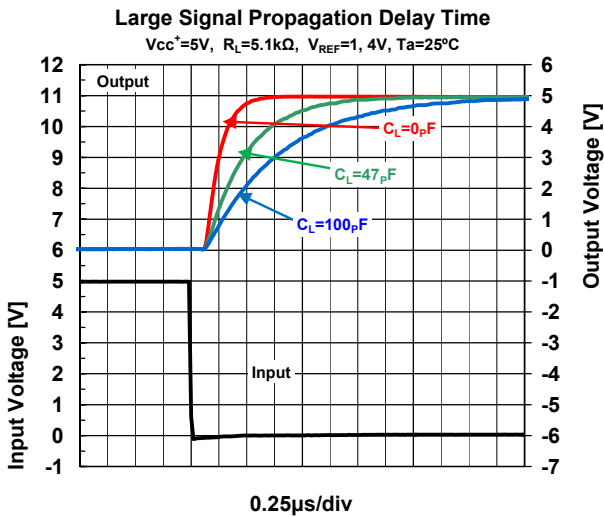
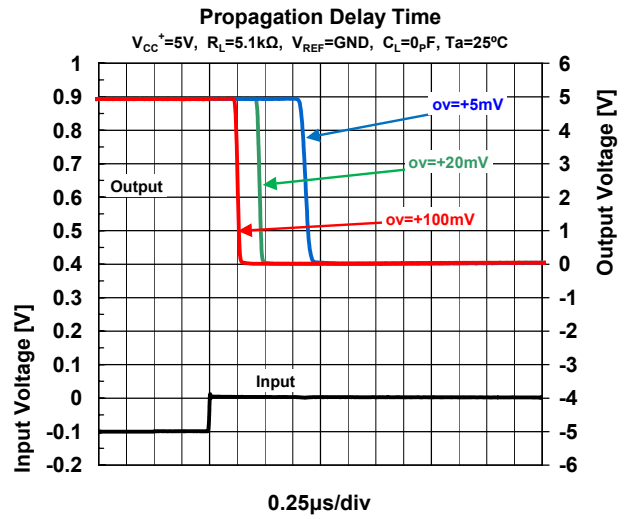
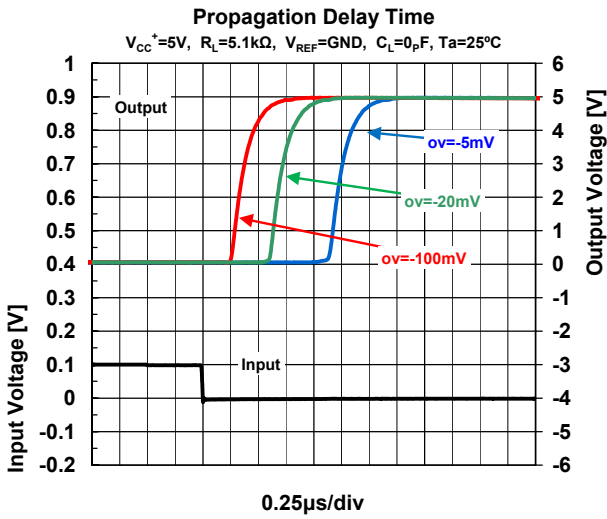

■PACKAGE OUTLINE UNIT : mm

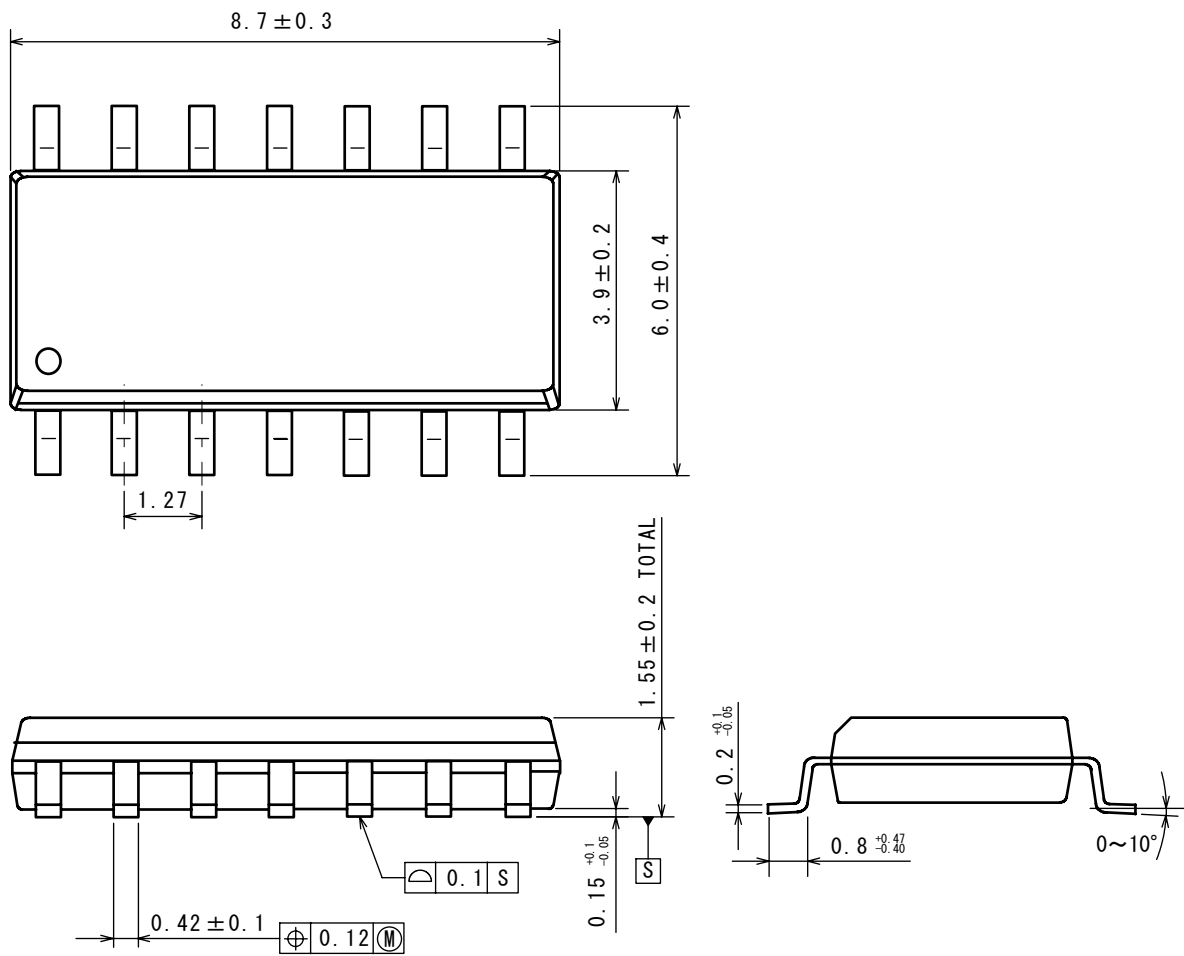

[CAUTION]
 The specifications on this databook are only given for information, without any guarantee as regards either mistakes or omissions. The application circuits in this databook are described only to show representative usages of the product and not intended for the guarantee or permission of any right including the industrial rights.