

Distributed by:

JAMECO[®]
ELECTRONICS

www.Jameco.com ♦ 1-800-831-4242

The content and copyrights of the attached
material are the property of its owner.

Jameco Part Number 880124

MURS320T3, MURS340T3, MURS360T3

Preferred Devices

Surface Mount Ultrafast Power Rectifiers

This series employs the state-of-the-art epitaxial construction with oxide passivation and metal overlay contact. Ideally suited for high voltage, high frequency rectification, or as free wheeling and protection diodes, in surface mount applications where compact size and weight are critical to the system.

Features

- Small Compact Surface Mountable Package with J-Bend Leads
- Rectangular Package for Automated Handling
- High Temperature Glass Passivated Junction
- Low Forward Voltage Drop
(0.71 to 1.05 Volts Max @ 3.0 A, $T_J = 150^\circ\text{C}$)
- Pb-Free Packages are Available

Mechanical Characteristics

- Case: Epoxy, Molded
- Epoxy Meets UL 94 V-0 @ 0.125 in
- Weight: 217 mg (approximately)
- Finish: All External Surfaces Corrosion Resistant and Terminal Leads are Readily Solderable
- Lead and Mounting Surface Temperature for Soldering Purposes: 260°C Max. for 10 Seconds
- Shipped in 16 mm Tape and Reel, 2500 units per reel
- Polarity: Notch in Plastic Body Indicates Cathode Lead
- Device Meets MSL1 Requirements
- ESD Ratings: Machine Model, C (> 400 V)
Human Body Model, 3B (> 8000 V)



ON Semiconductor®

<http://onsemi.com>

**ULTRAFAST
RECTIFIERS
3.0 AMPERES
200-600 VOLTS**



SMC
CASE 403
PLASTIC

MARKING DIAGRAM

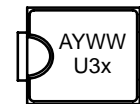

U3 = Specific Device Code
x = D (320T3)
= G (340T3)
= J (360T3)
A = Assembly Location
Y = Year
WW = Work Week

ORDERING INFORMATION

Device	Package	Shipping†
MURS320T3	SMC	2500/Tape & Reel
MURS320T3G	SMC (Pb-Free)	2500/Tape & Reel
MURS340T3	SMC	2500/Tape & Reel
MURS340T3G	SMC (Pb-Free)	2500/Tape & Reel
MURS360T3	SMC	2500/Tape & Reel
MURS360T3G	SMC (Pb-Free)	2500/Tape & Reel

†For information on tape and reel specifications, including part orientation and tape sizes, please refer to our Tape and Reel Packaging Specifications Brochure, BRD8011/D.

Preferred devices are recommended choices for future use and best overall value.

MURS320T3, MURS340T3, MURS360T3

MAXIMUM RATINGS

Rating	Symbol	MURS320T3	MURS340T3	MURS360T3	Unit
Peak Repetitive Reverse Voltage Working Peak Reverse Voltage DC Blocking Voltage	V_{RRM} V_{RWM} V_R	200	400	600	V
Average Rectified Forward Current	$I_{F(AV)}$	3.0 @ $T_L = 140^\circ\text{C}$ 4.0 @ $T_L = 130^\circ\text{C}$	3.0 @ $T_L = 130^\circ\text{C}$ 4.0 @ $T_L = 115^\circ\text{C}$	3.0 @ $T_L = 130^\circ\text{C}$ 4.0 @ $T_L = 115^\circ\text{C}$	A
Non-Repetitive Peak Surge Current (Surge applied at rated load conditions halfwave, single phase, 60 Hz)	I_{FSM}	75			A
Operating Junction Temperature	T_J	- 65 to +175			$^\circ\text{C}$

Maximum ratings are those values beyond which device damage can occur. Maximum ratings applied to the device are individual stress limit values (not normal operating conditions) and are not valid simultaneously. If these limits are exceeded, device functional operation is not implied, damage may occur and reliability may be affected.

THERMAL CHARACTERISTICS

Thermal Resistance, Junction-to-Lead	$R_{\theta JL}$	11	$^\circ\text{C/W}$
--------------------------------------	-----------------	----	--------------------

ELECTRICAL CHARACTERISTICS

Maximum Instantaneous Forward Voltage (Note 1) ($i_F = 3.0\text{ A}$, $T_J = 25^\circ\text{C}$) ($i_F = 4.0\text{ A}$, $T_J = 25^\circ\text{C}$) ($i_F = 3.0\text{ A}$, $T_J = 150^\circ\text{C}$)	V_F	0.875 0.89 0.71	1.25 1.28 1.05	1.25 1.28 1.05	V
Maximum Instantaneous Reverse Current (Note 1) (Rated dc Voltage, $T_J = 25^\circ\text{C}$) (Rated dc Voltage, $T_J = 150^\circ\text{C}$)	i_R	5.0 150	10 250	10 250	μA
Maximum Reverse Recovery Time ($i_F = 1.0\text{ A}$, $di/dt = 50\text{ A}/\mu\text{s}$) ($i_F = 0.5\text{ A}$, $i_R = 1.0\text{ A}$, I_{REC} to 0.25 A)	t_{rr}	35 25	75 50	75 50	ns
Maximum Forward Recovery Time ($i_F = 1.0\text{ A}$, $di/dt = 100\text{ A}/\mu\text{s}$, Recovery to 1.0 V)	t_{fr}	25	50	50	ns

1. Pulse Test: Pulse Width = 300 μs , Duty Cycle $\leq 2.0\%$.

MURS320T3, MURS340T3, MURS360T3

MURS320T3

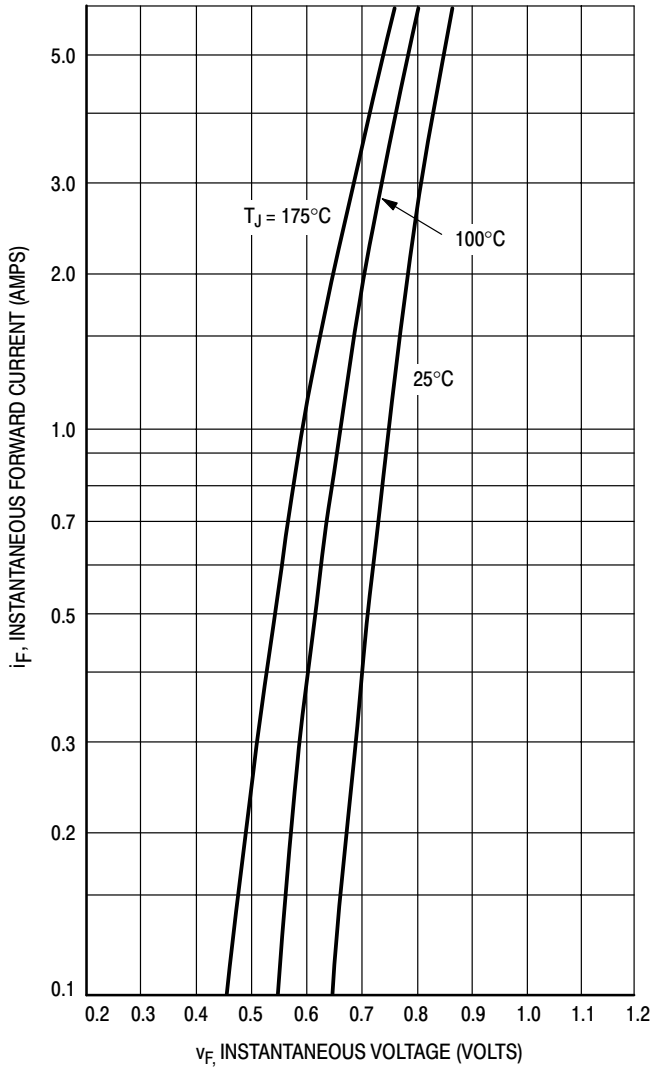

Figure 1. Typical Forward Voltage

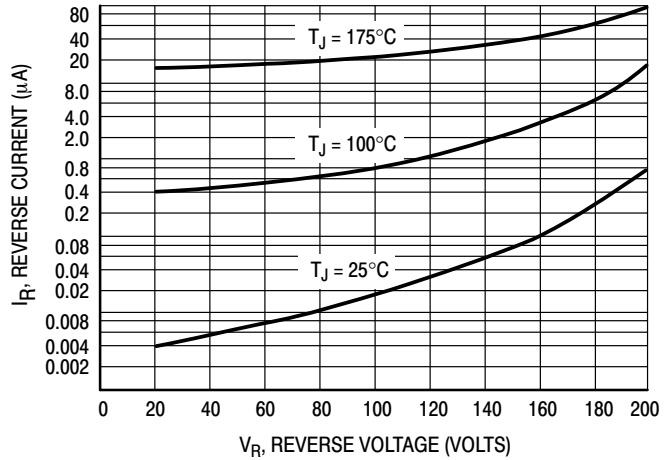

Figure 2. Typical Reverse Current*

* The curves shown are typical for the highest voltage device in the voltage grouping. Typical reverse current for lower voltage selections can be estimated from these same curves if V_{R1} is sufficiently below rated V_R .

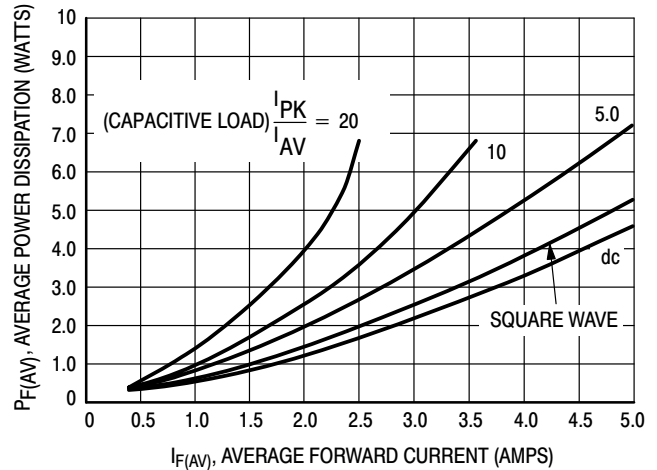

Figure 3. Power Dissipation

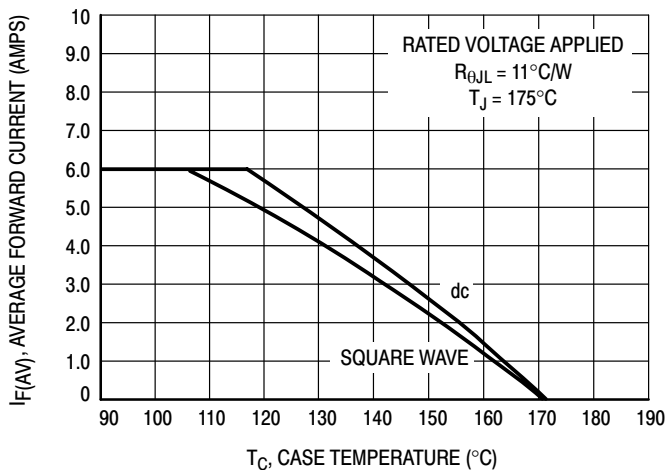

Figure 4. Current Derating, Case

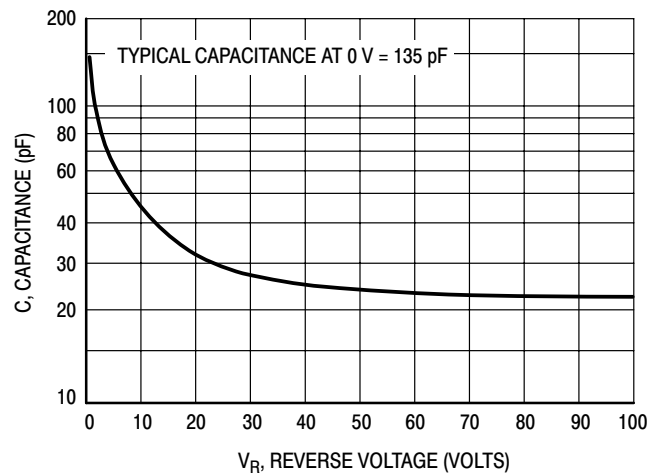

Figure 5. Typical Capacitance

MURS320T3, MURS340T3, MURS360T3

MURS340T3, MURS360T3

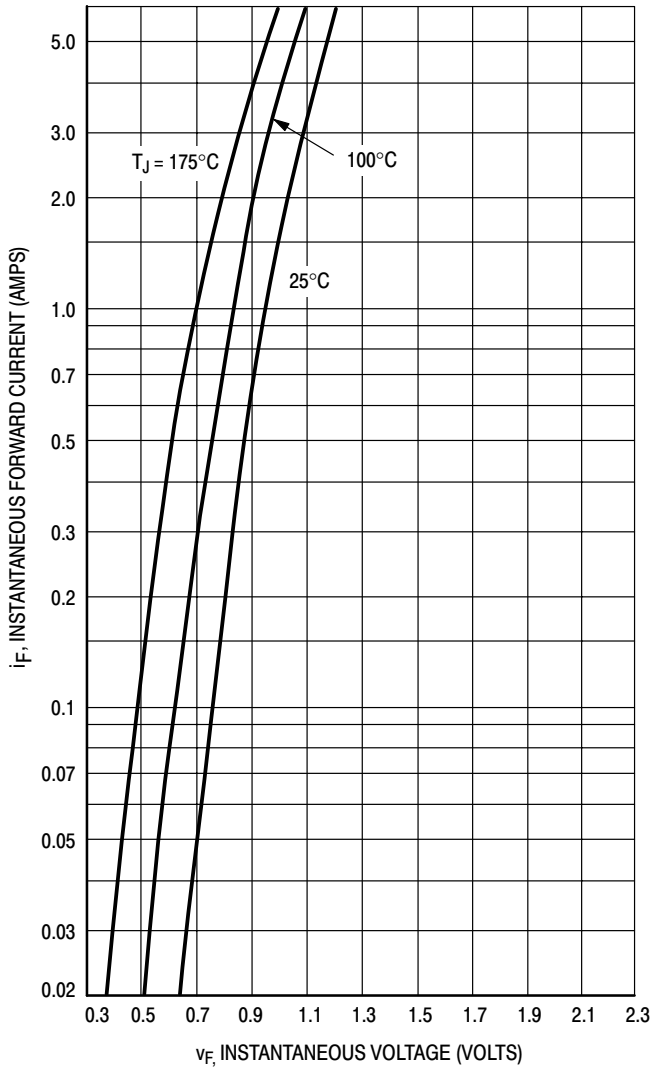

Figure 6. Typical Forward Voltage

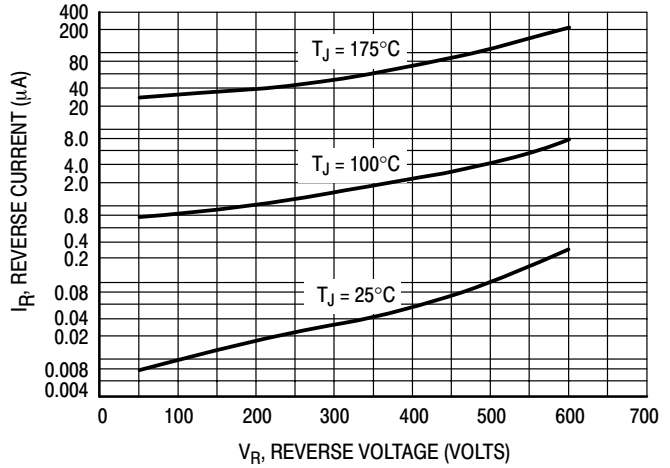

Figure 7. Typical Reverse Current*

* The curves shown are typical for the highest voltage device in the voltage grouping. Typical reverse current for lower voltage selections can be estimated from these same curves if V_R is sufficiently below rated V_R .

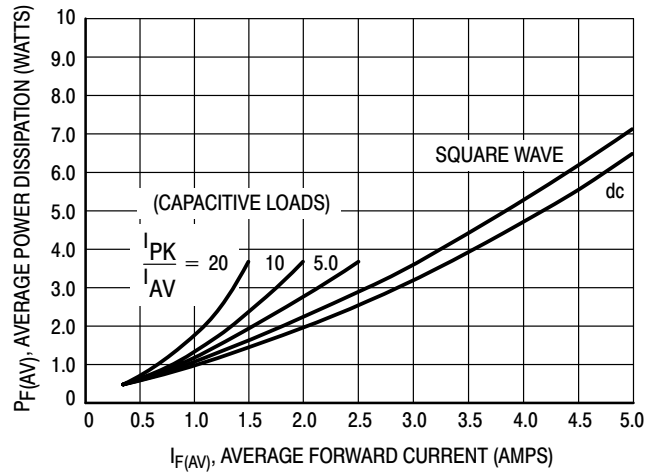

Figure 8. Power Dissipation

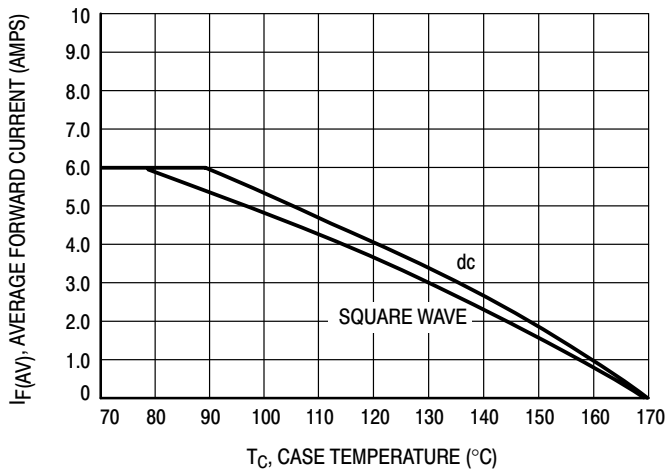

Figure 9. Current Derating, Case

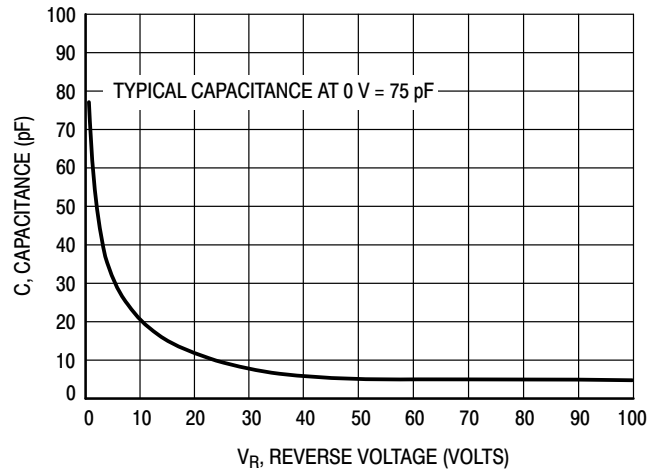
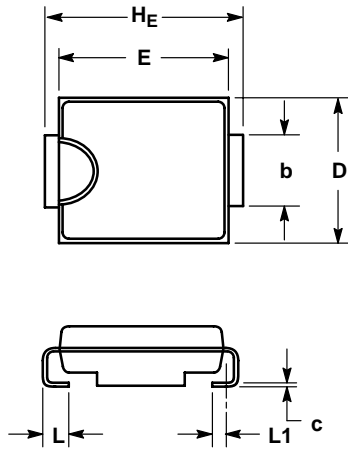

Figure 10. Typical Capacitance

MURS320T3, MURS340T3, MURS360T3

PACKAGE DIMENSIONS

SMC
PLASTIC PACKAGE
CASE 403-03
ISSUE E



NOTES:

1. DIMENSIONING AND TOLERANCING PER ANSI Y14.5M, 1982.
2. CONTROLLING DIMENSION: INCH.
3. D DIMENSION SHALL BE MEASURED WITHIN DIMENSION P.
4. 403-01 THRU -02 OBSOLETE, NEW STANDARD 403-03.

DIM	MILLIMETERS			INCHES		
	MIN	NOM	MAX	MIN	NOM	MAX
A	1.90	2.13	2.41	0.075	0.084	0.095
A1	0.05	0.10	0.15	0.002	0.004	0.006
b	2.92	3.00	3.07	0.115	0.118	0.121
c	0.15	0.23	0.30	0.006	0.009	0.012
D	5.59	5.84	6.10	0.220	0.230	0.240
E	6.60	6.86	7.11	0.260	0.270	0.280
HE	7.75	7.94	8.13	0.305	0.313	0.320
L	0.76	1.02	1.27	0.030	0.040	0.050
L1	0.51 REF			0.020 REF		

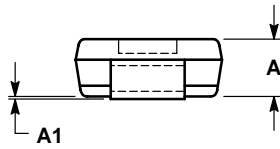

SOLDERING FOOTPRINT*

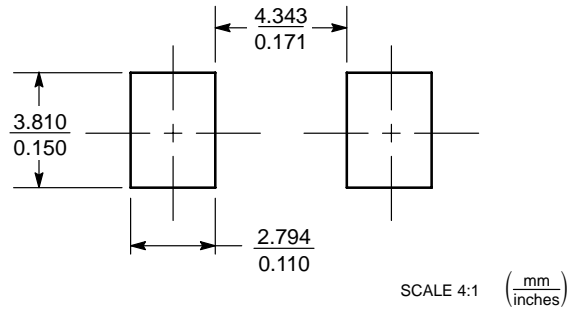

*For additional information on our Pb-Free strategy and soldering details, please download the ON Semiconductor Soldering and Mounting Techniques Reference Manual, SOLDERRM/D.

MURS320T3, MURS340T3, MURS360T3

ON Semiconductor and  are registered trademarks of Semiconductor Components Industries, LLC (SCILLC). SCILLC reserves the right to make changes without further notice to any products herein. SCILLC makes no warranty, representation or guarantee regarding the suitability of its products for any particular purpose, nor does SCILLC assume any liability arising out of the application or use of any product or circuit, and specifically disclaims any and all liability, including without limitation special, consequential or incidental damages. "Typical" parameters which may be provided in SCILLC data sheets and/or specifications can and do vary in different applications and actual performance may vary over time. All operating parameters, including "Typicals" must be validated for each customer application by customer's technical experts. SCILLC does not convey any license under its patent rights nor the rights of others. SCILLC products are not designed, intended, or authorized for use as components in systems intended for surgical implant into the body, or other applications intended to support or sustain life, or for any other application in which the failure of the SCILLC product could create a situation where personal injury or death may occur. Should Buyer purchase or use SCILLC products for any such unintended or unauthorized application, Buyer shall indemnify and hold SCILLC and its officers, employees, subsidiaries, affiliates, and distributors harmless against all claims, costs, damages, and expenses, and reasonable attorney fees arising out of, directly or indirectly, any claim of personal injury or death associated with such unintended or unauthorized use, even if such claim alleges that SCILLC was negligent regarding the design or manufacture of the part. SCILLC is an Equal Opportunity/Affirmative Action Employer. This literature is subject to all applicable copyright laws and is not for resale in any manner.

PUBLICATION ORDERING INFORMATION

LITERATURE FULFILLMENT:

Literature Distribution Center for ON Semiconductor
P.O. Box 61312, Phoenix, Arizona 85082-1312 USA

Phone: 480-829-7710 or 800-344-3860 Toll Free USA/Canada

Fax: 480-829-7709 or 800-344-3867 Toll Free USA/Canada

Email: orderlit@onsemi.com

N. American Technical Support: 800-282-9855 Toll Free
USA/Canada

Japan: ON Semiconductor, Japan Customer Focus Center
2-9-1 Kamimeguro, Meguro-ku, Tokyo, Japan 153-0051
Phone: 81-3-5773-3850

ON Semiconductor Website: <http://onsemi.com>

Order Literature: <http://www.onsemi.com/litorder>

For additional information, please contact your
local Sales Representative.

MURS320T3/D