

Distributed by:

JAMECO[®]
ELECTRONICS

www.Jameco.com ♦ 1-800-831-4242

The content and copyrights of the attached
material are the property of its owner.

Jameco Part Number 786664

MMBD4148/SE/CC/CA

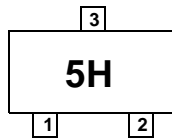
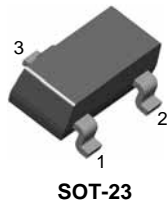

MARKING
MMBD4148 5H MMBD4148CA D6
MMBD4148CC D5 MMBD4148SE D4

Connection Diagram

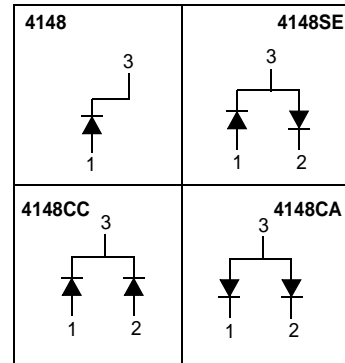

Small Signal Diode

Absolute Maximum Ratings * $T_A = 25^\circ\text{C}$ unless otherwise noted

Symbol	Parameter	Value	Units
V_{RRM}	Maximum Repetitive Reverse Voltage	100	V
$I_{F(AV)}$	Average Rectified Forward Current	200	mA
I_{FSM}	Non-repetitive Peak Forward Surge Current Pulse Width = 1.0 second Pulse Width = 1.0 microsecond	1.0	A
		2.0	A
T_{STG}	Storage Temperature Range	-55 to +150	$^\circ\text{C}$
T_J	Operating Junction Temperature	150	$^\circ\text{C}$

* These ratings are limiting values above which the serviceability of the diode may be impaired.

Thermal Characteristics

Symbol	Parameter	Value	Units
P_D	Power Dissipation	350	mW
$R_{\theta JA}$	Thermal Resistance, Junction to Ambient	357	$^\circ\text{C/W}$

Electrical Characteristics $T_A = 25^\circ\text{C}$ unless otherwise noted

Symbol	Parameter	Test Conditions	Min.	Max.	Units
V_R	Breakdown Voltage	$I_R = 5.0\mu\text{A}$	75		V
		$I_R = 100\mu\text{A}$	100		V
V_F	Forward Voltage	$I_F = 10\text{mA}$		1.0	V
I_R	Reverse Leakage Current	$V_R = 20\text{V}$		25	nA
		$V_R = 20\text{V}, T_A = 150^\circ\text{C}$		50	μA
		$V_R = 75\text{V}$		5.0	μA
C_T	Total Capacitance	$V_R = 0\text{V}, f = 1.0\text{MHz}$		4.0	pF
t_{rr}	Reverse Recovery Time	$I_F = 10\text{mA}, V_R = 6.0\text{V}, I_{RR} = 1.0\text{mA}, R_L = 100\Omega$		4.0	ns

Typical Characteristics

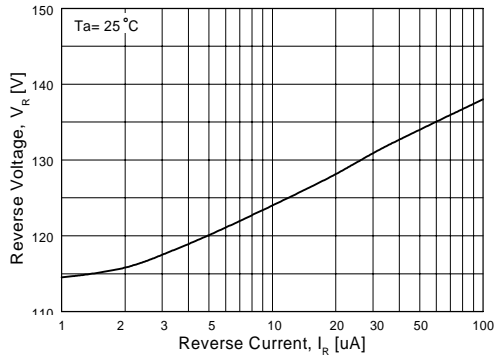

**Figure 1. Reverse Voltage vs Reverse Current
BV - 1.0 to 100uA**

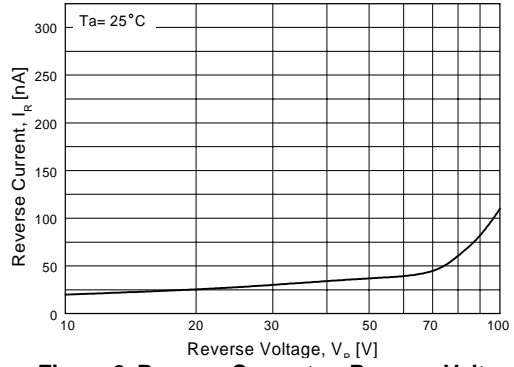

**Figure 2. Reverse Current vs Reverse Voltage
IR - 10 to 100 V**

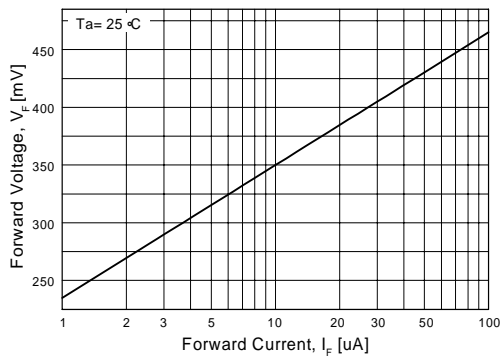

**Figure 3. Forward Voltage vs Forward Current
VF - 1.0 to 100 uA**

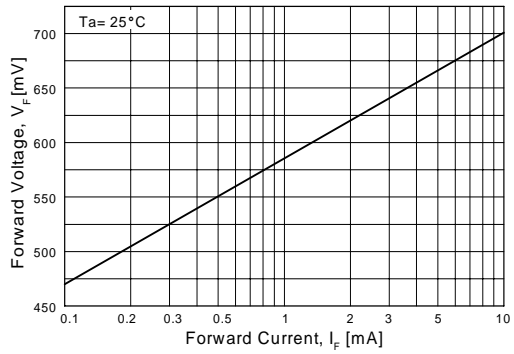

**Figure 4. Forward Voltage vs Forward Current
VF - 0.1 to 10 mA**

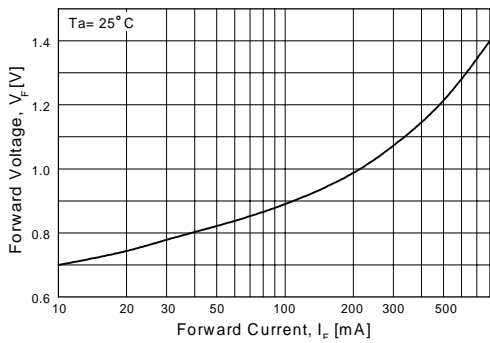

**Figure 5. Forward Voltage vs Forward Current
VF - 10 - 800 mA**

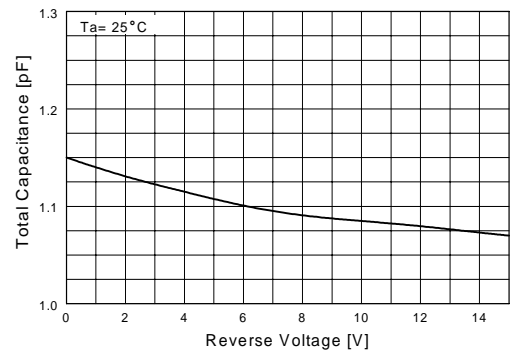

Figure 6. Total Capacitance vs Reverse Voltage

Typical Characteristics (continued)

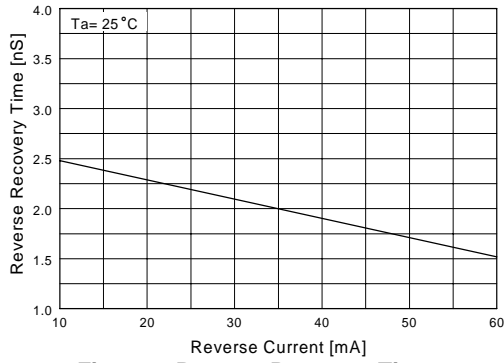

Figure 7. Reverse Recovery Time vs Reverse Current
TRR - IR 10 mA vs 60 mA

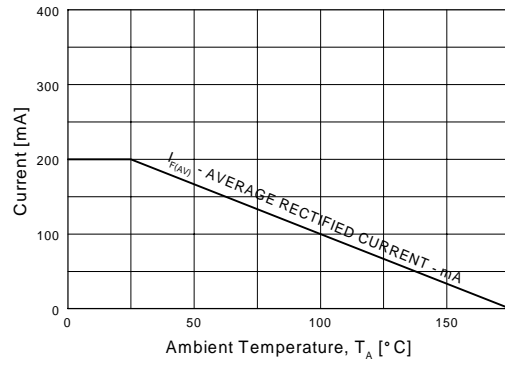

Figure 8. Average Rectified Current ($I_{F(AV)}$) versus Ambient Temperature (T_A)

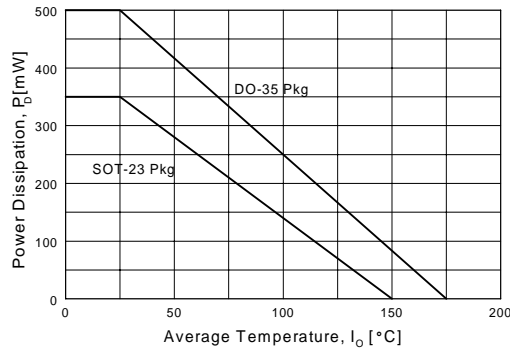

Figure 9. Power Derating Curve

TRADEMARKS

The following are registered and unregistered trademarks Fairchild Semiconductor owns or is authorized to use and is not intended to be an exhaustive list of all such trademarks.

ACEx™	FAST®	ISOPLANAR™	Power247™	SuperFET™
ActiveArray™	FASTr™	LittleFET™	PowerSaver™	SuperSOT™-3
Bottomless™	FPST™	MICROCOUPLER™	PowerTrench®	SuperSOT™-6
CoolFET™	FRFET™	MicroFET™	QFET®	SuperSOT™-8
CROSSVOLT™	GlobalOptoisolator™	MicroPak™	QST™	SyncFET™
DOMETM	GTO™	MICROWIRE™	QT Optoelectronics™	TinyLogic®
EcoSPARK™	HiSeC™	MSX™	Quiet Series™	TINYOPTO™
E ² C MOS™	I ² C™	MSXPro™	RapidConfigure™	TruTranslation™
EnSigna™	<i>i-Lo</i> ™	OCX™	RapidConnect™	UHC™
FACT™	ImpliedDisconnect™	OCXPro™	μSerDes™	UltraFET®
FACT Quiet Series™		OPTOLOGIC®	SILENT SWITCHER®	VCX™
Across the board. Around the world.™		OPTOPLANAR™	SMART START™	
The Power Franchise®		PACMAN™	SPM™	
Programmable Active Droop™		POP™	Stealth™	

DISCLAIMER

FAIRCHILD SEMICONDUCTOR RESERVES THE RIGHT TO MAKE CHANGES WITHOUT FURTHER NOTICE TO ANY PRODUCTS HEREIN TO IMPROVE RELIABILITY, FUNCTION OR DESIGN. FAIRCHILD DOES NOT ASSUME ANY LIABILITY ARISING OUT OF THE APPLICATION OR USE OF ANY PRODUCT OR CIRCUIT DESCRIBED HEREIN; NEITHER DOES IT CONVEY ANY LICENSE UNDER ITS PATENT RIGHTS, NOR THE RIGHTS OF OTHERS.

LIFE SUPPORT POLICY

FAIRCHILD'S PRODUCTS ARE NOT AUTHORIZED FOR USE AS CRITICAL COMPONENTS IN LIFE SUPPORT DEVICES OR SYSTEMS WITHOUT THE EXPRESS WRITTEN APPROVAL OF FAIRCHILD SEMICONDUCTOR CORPORATION.

As used herein:

1. Life support devices or systems are devices or systems which, (a) are intended for surgical implant into the body, or (b) support or sustain life, or (c) whose failure to perform when properly used in accordance with instructions for use provided in the labeling, can be reasonably expected to result in significant injury to the user.
2. A critical component is any component of a life support device or system whose failure to perform can be reasonably expected to cause the failure of the life support device or system, or to affect its safety or effectiveness.

PRODUCT STATUS DEFINITIONS

Definition of Terms

Datasheet Identification	Product Status	Definition
Advance Information	Formative or In Design	This datasheet contains the design specifications for product development. Specifications may change in any manner without notice.
Preliminary	First Production	This datasheet contains preliminary data, and supplementary data will be published at a later date. Fairchild Semiconductor reserves the right to make changes at any time without notice in order to improve design.
No Identification Needed	Full Production	This datasheet contains final specifications. Fairchild Semiconductor reserves the right to make changes at any time without notice in order to improve design.
Obsolete	Not In Production	This datasheet contains specifications on a product that has been discontinued by Fairchild semiconductor. The datasheet is printed for reference information only.