

Professional Thin Film Leaded Resistors

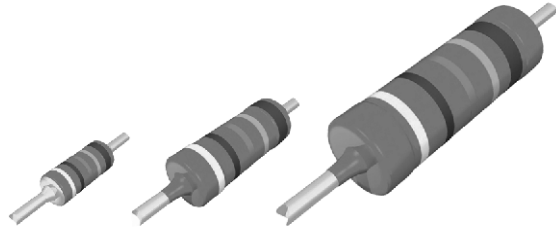

DESCRIPTION

MBA/SMA 0204, MBB/SMA 0207 and MBE/SMA 0414 professional leaded thin film resistors are the general purpose resistor for all fields of professional electronics where reliability and stability is of major concern. Typical applications include industrial, telecommunication and medical equipment.

FEATURES

- Available in standard version or CECC version (approved according to CECC 40101-806)
- Advanced thin film technology
- Power dissipation rating up to 1 W
- Excellent overall stability: Class 0.25
- Wide professional range: 0.22 Ω to 22 MΩ
- Lead (Pb)-free solder contacts
- Pure tin plating provides compatibility with lead (Pb)-free and lead containing soldering processes
- Compliant to RoHS directive 2002/95/EC
- AEC-Q200 qualified



RoHS
COMPLIANT

APPLICATIONS

- Industrial
- Telecommunication
- Medical equipment

METRIC SIZE

DIN	0204	0207	0414
CECC	A	B	D

TECHNICAL SPECIFICATIONS

DESCRIPTION	MBA/SMA 0204		MBB/SMA 0207		MBE/SMA 0414	
CECC Size	A		B		D	
Resistance Range	0.22 Ω to 10 MΩ		0.22 Ω to 22 MΩ		0.22 Ω to 22 MΩ	
Resistance Tolerance	± 5 %; ± 1 %; ± 0.5 %					
Temperature Coefficient	± 50 ppm/K; ± 25 ppm/K					
Operation Mode	Long term	Standard	Long term	Standard	Long term	Standard
Climatic Category (LCT/UCT/Days)	55/125/56	55/155/56	55/125/56	55/155/56	55/125/56	55/155/56
Rated Dissipation, P_{70}	0.25 W	0.4 W	0.4 W	0.6 W	0.65 W	1.0 W
Operating Voltage, U_{max} AC/DC	200 V		350 V		500 V	
Film Temperature	125 °C	155 °C	125 °C	155 °C	125 °C	155 °C
Max. Resistance Change at P_{70} for Resistance Range, $\Delta R/R$ max., After:	1 Ω to 332 kΩ		1 Ω to 1 MΩ		1 Ω to 2.4 MΩ	
1000 h	≤ 0.25 %	≤ 0.5 %	≤ 0.25 %	≤ 0.5 %	≤ 0.2 %	≤ 0.4 %
8000 h	≤ 0.5 %	≤ 1.0 %	≤ 0.5 %	≤ 1.0 %	≤ 0.4 %	≤ 0.8 %
225 000 h	≤ 1.5 %	-	≤ 1.5 %	-	≤ 1.2 %	-
Permissible Voltage Against Ambient (Insulation):						
1 Minute; U_{ins}	300 V		500 V		800 V	
Continuous	75 V		75 V		75 V	
Failure Rate: FIT _{observed}	≤ 0.1 x 10 ⁻⁹ /h		≤ 0.1 x 10 ⁻⁹ /h		≤ 0.1 x 10 ⁻⁹ /h	

Notes

- MB_ series has been merged with the related SMA series to form one series "MB_/SMA_"
- These resistors do not feature a limited lifetime when operated within the permissible limits. However, resistance value drift increasing over operating time may result in exceeding a limit acceptable to the specific application, thereby establishing a functional lifetime.



MBA/SMA 0204, MBB/SMA 0207, MBE/SMA 0414 - Professional

Professional Thin Film Leaded Resistors

Vishay Beyschlag

PART NUMBER AND PRODUCT DESCRIPTION																	
PART NUMBER: MBB02070C1001FCT00																	
M	B	B	0	2	0	7	0	C	1	0	0	1	F	C	T	0	0
MODEL/SIZE	VARIANT		TCR/MATERIAL		VALUE			TOLERANCE		PACKAGING ⁽¹⁾		SPECIAL					
MBA0204 = MBA/SMA 0204 MBB0207 = MBB/SMA 0207 MBE0414 = MBE/SMA 0414	0 = Neutral V = CECC 06 N = RB Radial 5 mm for MBB/SMA0207 S = UB Radial 2.5 mm for MBB/SMA0207 I = L0 (without lacquer on termination for MBB/SMA0207)		D = ± 25 ppm/K C = ± 50 ppm/K Z = Jumper		3 digit value 1 digit multiplier MULTIPLIER 7 = *10 ⁻³ 2 = *10 ² 8 = *10 ⁻² 3 = *10 ³ 9 = *10 ⁻¹ 4 = *10 ⁴ 0 = *10 ⁰ 5 = *10 ⁵ 1 = *10 ¹ 6 = *10 ⁶ 0000 = Jumper			D = ± 0.5 % F = ± 1 % J = ± 5 % Z = Jumper		CT C1 RP R1 R2 R4 N4		00 = Standard					
PRODUCT DESCRIPTION: MBB/SMA 0207-50 1% CT 1K0																	
MBB/SMA 0207		-	50		1%				CT		1K0						
MODEL/SIZE			TCR		TOLERANCE		VARIANT		PACKAGING ⁽¹⁾		RESISTANCE						
MBA/SMA 0204 MBB/SMA 0207 MBE/SMA 0414			± 25 ppm/K ± 50 ppm/K		± 0.5 % ± 1.0 % ± 5.0 %		CECC 06 RB UB L0		CT C1 RP R1 R2 R4 N4		1K0 = 1 kΩ 51R1 = 51.1 Ω						

Notes

⁽¹⁾Please refer to table PACKAGING for complete information

- The PART NUMBER shown above is to facilitate the unified part numbering system for ordering products

PACKAGING				
MODEL	REEL		BOX	
	PIECES	CODE	PIECES	CODE
MBA/SMA 0204	1000 5000	R1 RP	1000 5000	C1 CT
MBB/SMA 0207	1000 5000	R1 RP	1000 5000	C1 CT
MBB/SMA 0207 radial version (variant N = RB, variant S = UB)	4000	R4	4000	N4
MBE/SMA 0414	2500	R2	1000	C1

DIMENSIONS

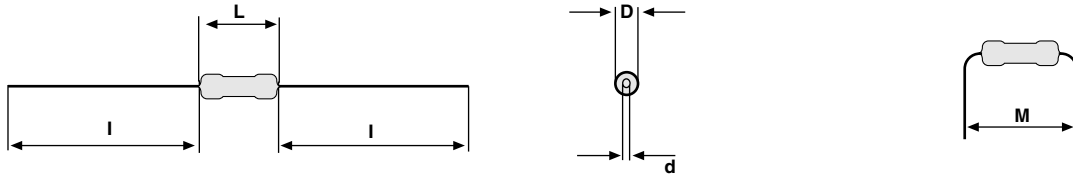

DIMENSIONS - Leaded resistor types, mass and relevant physical dimensions						
TYPE	D _{max.} (mm)	L _{max.} (mm)	d _{nom.} (mm)	l _{min.} (mm)	M _{min.} (mm)	MASS (mg)
MBA/SMA 0204	1.6	3.6	0.5	29.0	5.0	125
MBB/SMA 0207	2.5	6.5	0.6	28.0	10.0 ⁽¹⁾	220
MBE/SMA 0414	4.2	11.9	0.8	31.0	15.0	700

Note

⁽¹⁾ For $7.5 \leq M < 10.0$ mm, use version MBB/SMA 0207 ... L0 without lacquer on the leads

MBB/SMA 0207 WITH RADIAL TAPING

LEAD SPACING (Variant S = UB) 2.5 mm, SIZE 0207

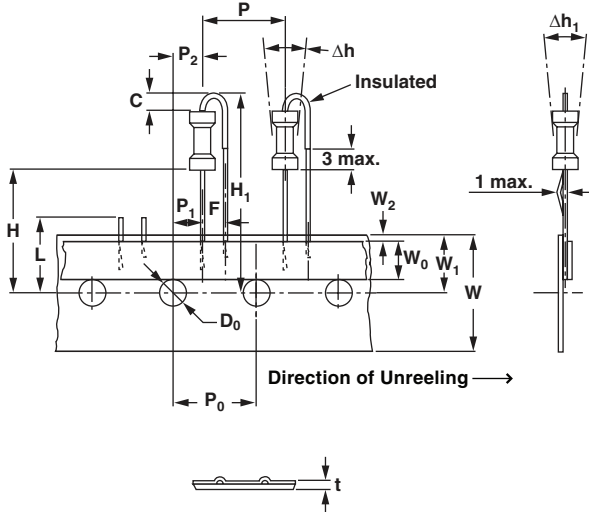

DIMENSIONS in millimeters			TOL.
Lead Ø	d	0.6	-
Pitch of components	P	12.7	± 1.0
Pitch of sprocket holes ⁽¹⁾	P ₀	12.7	± 0.3
Distance between hole center and lead center	P ₁	5.1	± 0.7
Distance between hole center and resistor center	P ₂	5.1	± 0.7
Lead Spacing	F	2.5	+ 0.6, - 0.1
Angle of insertion	Δh	1.3 max.	-
Angle of insertion	Δh ₁	2 max.	-
Width of carrier tape	W	18.0	+ 1, - 0.5
Width of adhesive tape	W ₀	6.0	± 0.5
Position of holes	W ₁	9.0	+ 0.75, - 0.5
Position of adhesive tape	W ₂	0.5	+ 0.5, - 0
Body to hole center ⁽²⁾	H	18.0	± 2, - 0
Hole Ø	D ₀	4.0	+ 0.2
Thickness of tape ⁽³⁾	t	0.9 max.	-
Height for cutting	L	11 max.	-
Height for bending	C	2.5	+ 0, - 0.5
Height for insertion	H ₁	32 max.	-

LEAD SPACING (Variant N = RB) 5.0 mm, SIZE 0207

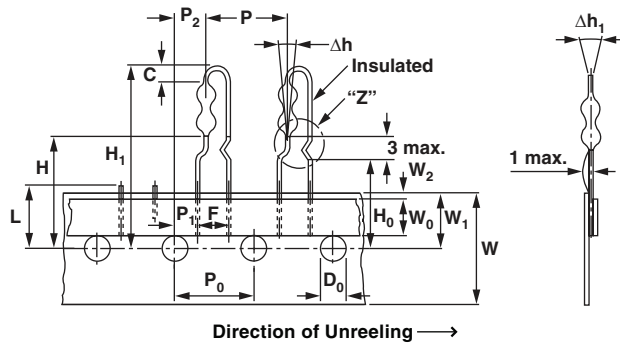

Area "Z"

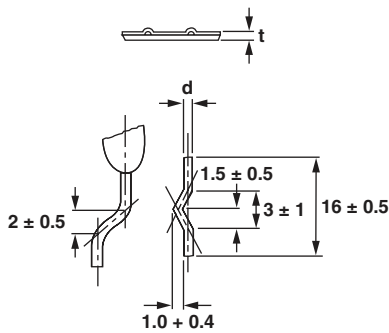

DIMENSIONS in millimeters			TOL.
Lead Ø	d	0.6	-
Pitch of components	P	12.7	± 1.0
Tape pitch	P ₀	12.7	± 0.3
Distance between hole center and lead center	P ₁	3.85	± 0.7
Distance between hole center and resistor center	P ₂	6.35	± 0.7
Lead spacing	F	5.0	+ 0.6, - 0.1
Angle of insertion	Δh	1.3 max.	-
Angle of insertion	Δh ₁	2 max.	-
Width of carrier tape	W	18.0	+ 1, - 0.5
Width of adhesive tape	W ₀	6.0	± 0.5
Position of holes	W ₁	9.0	+ 0.75, - 0.5
Position of adhesive tape	W ₂	0.5	+ 0.5, - 0
Body to hole center ⁽²⁾	H	18.0	+ 2, - 0
Lead crimp to hole center ⁽²⁾	H ₀	16.0	± 0.5
Hole Ø	D ₀	4.0	± 0.2
Thickness of tape ⁽³⁾	t	0.9 max.	-
Height for cutting	L	11 max.	-
Height for bending	C	2.5	+ 0, - 0.5
Height for insertion	H ₁	32 max.	-

Notes:

(1) Test over 10 holes - 9 intervals P₀ 12 x 9 = 114.3 ± 0.5

(2) Parallelism, < 0.5 mm

(3) Thickness of carrier tape: 0.55 mm ± 0.1 mm

TEMPERATURE COEFFICIENT AND RESISTANCE RANGE

DESCRIPTION		RESISTANCE VALUE ⁽⁴⁾		
TCR	TOLERANCE	MBA/SMA 0204	MBB/SMA 0207	MBE/SMA 0414
± 50 ppm/K	± 5 %	0.22 Ω to 0.91 Ω	0.22 Ω to 0.91 Ω 11 MΩ to 22 MΩ	0.22 Ω to 0.91 Ω
	± 2 %	-	0.22 Ω to 0.91 Ω	-
	± 1 %	1 Ω to 10 MΩ	1 Ω to 10 MΩ	1 Ω to 22 MΩ
	± 0.5 %	10 Ω to 475 kΩ	10 Ω to 1 MΩ	10 Ω to 2.4 MΩ
± 25 ppm/K	± 1 %	10 Ω to 475 kΩ	10 Ω to 1 MΩ	10 Ω to 2.4 MΩ
	± 0.5 %	10 Ω to 475 kΩ	10 Ω to 1 MΩ	10 Ω to 2.4 MΩ
Jumper	-	≤ 10 mΩ; I _{max.} = 3.0 A	≤ 10 mΩ, I _{max.} = 5.0 A	-

Notes

(4) Resistance value to be selected from E24 series for ± 5 %, ± 2 % tolerance, from E24/E96 series for ± 1 % tolerance and from E24/E192 for ± 0.5 % tolerance

- Resistance ranges printed in bold are preferred TCR/tolerance combinations with optimized availability

DESCRIPTION

Production is strictly controlled and follows an extensive set of instructions established for reproducibility. A homogeneous film of metal alloy is deposited on a high grade ceramic body and conditioned to achieve the desired temperature coefficient. Plated steel termination caps are firmly pressed on the metallized rods. A special laser is used to achieve the target value by smoothly cutting a helical groove in the resistive layer without damaging the ceramics. Connecting wires of electrolytic copper plated with 100 % pure tin are welded to the termination caps. The resistor elements are covered by a light blue protective coating designed for electrical, mechanical and climatic protection. Four or five color code rings designate the resistance value and tolerance in accordance with **IEC 60062**.

The result of the determined production is verified by an extensive testing procedure performed on 100 % of the individual resistors. Only accepted products are stuck directly on the adhesive tapes in accordance with **IEC 60286-1; IEC 60286-2**.

ASSEMBLY

The resistors are suitable for processing on automatic insertion equipment and cutting and bending machines. Excellent solderability is proven, even after extended storage. They are suitable for automatic soldering using wave or dipping. The encapsulation is resistant to all cleaning solvents commonly used in the electronics industry, including alcohols, esters and aqueous solutions. The suitability of conformal coatings, if applied, shall be qualified by appropriate means to ensure the long-term stability of the whole system. The resistors are completely lead (Pb)-free, the pure tin plating provides compatibility with lead (Pb)-free and lead-containing soldering processes. The immunity of the plating against tin whisker growth has been proven under extensive testing. All products comply with **GADSL** ⁽¹⁾ and the **CEFIC-EECA-EICTA** ⁽²⁾ list of legal restrictions on hazardous substances. This includes full compliance with the following directives:

- 2000/53/EC End of Vehicle Life Directive (ELV) and Annex II (ELVII)
- 2002/95/EC Restriction of the use of Hazardous Substances Directive (RoHS)
- 2002/96/EC Waste Electrical and Electrical Equipment Directive (WEEE)

APPROVALS

The resistors (CECC version) are approved within the IECQ-CECC Quality Assessment System for Electronic Components to the detail specification **CECC 40101-806** which refers to **EN 60115-1** and **EN 140100** and the variety of environmental test procedures of the **IEC 60068** series. Conformity is attested by the use of the **CECC** logo () as the Mark of Conformity on the package label for CECC version.

Vishay BEYSCHLAG has achieved "**Approval of Manufacturer**" in accordance with **IEC QC 001002-3, clause 2**. The release certificate for "**Technology Approval Schedule**" in accordance with **CECC 240001** based on **IEC QC 001002-3, clause 6** is granted for the Vishay BEYSCHLAG manufacturing process.

RELATED PRODUCTS

This product family of leaded thin film resistors for professional applications is complemented by **Zero Ohm Jumpers**.

For a correlated range of precision TCR and tolerance specifications see the datasheet:

- "Precision Thin Film Leaded Resistors", document no. 28767

For products approved to CECC 40101-806, version E, with established reliability and failure rate level E7 (Quality factor $\pi_Q = 0.1$), see the datasheet:

- "Established Reliability Thin Film Leaded Resistors", document no. 28768

Notes

⁽¹⁾ Global Automotive Declarable Substance List, see www.gadsl.org

⁽²⁾ CEFIC (European Chemical Industry Council), EECA (European Electronic Component Manufacturers Association), EICTA (European trade organisation representing the information and communications technology and consumer electronics), see www.eicta.org/index.php?id=1053&id_article=340



FUNCTIONAL PERFORMANCE

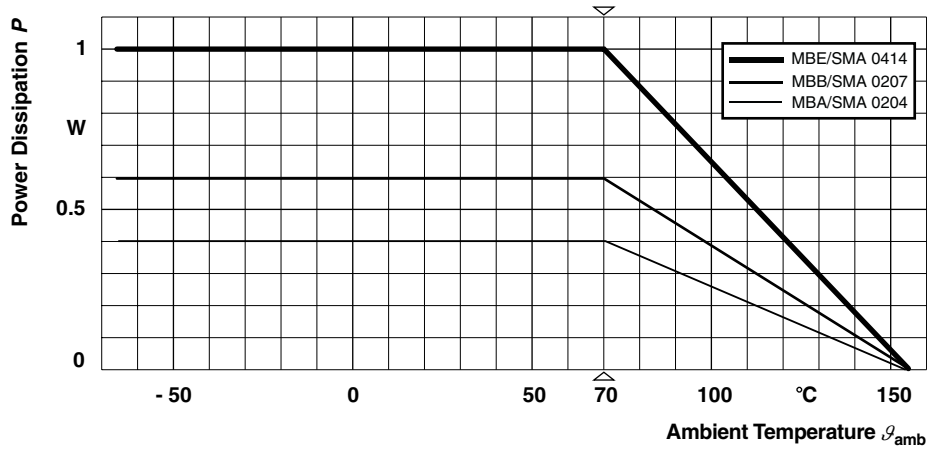

Derating - Standard Operation

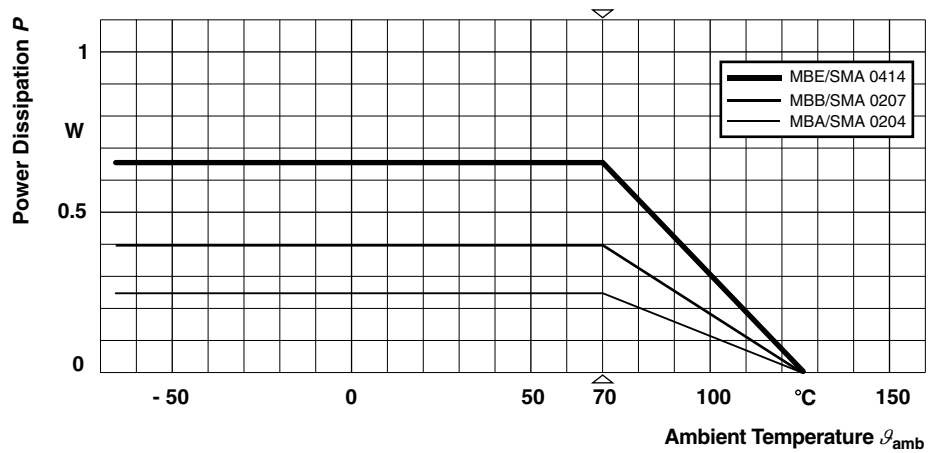

Derating Long Term Operation

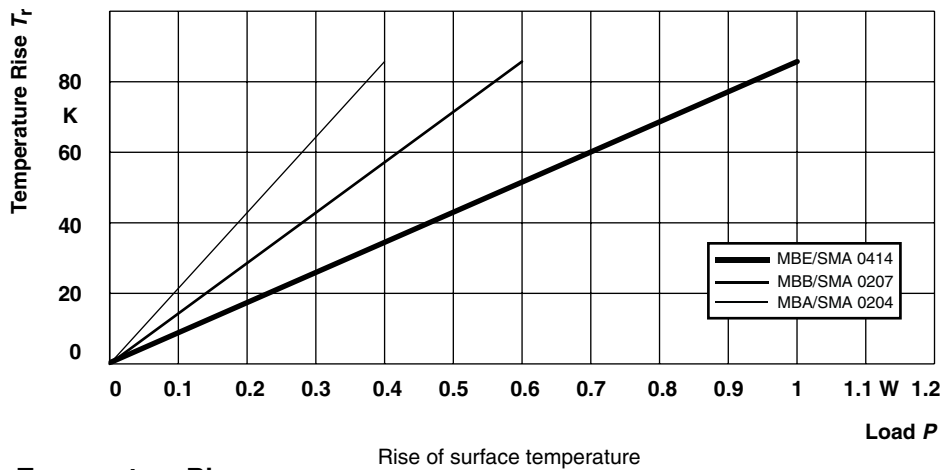

Temperature Rise

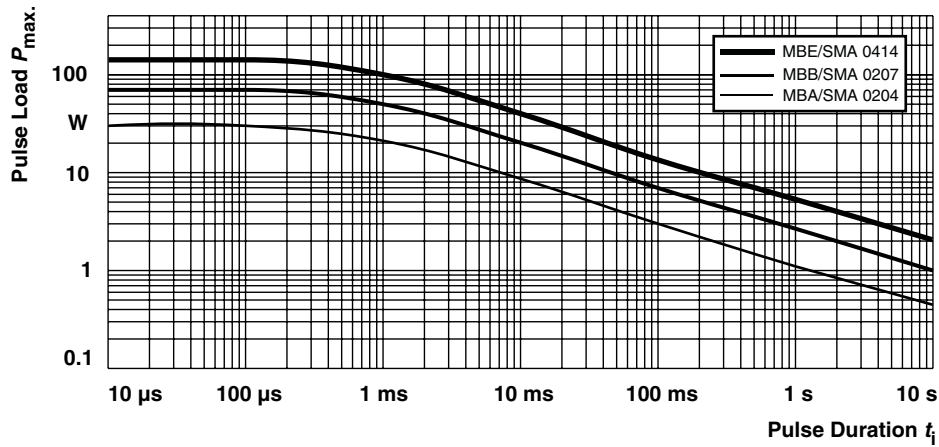

Single Pulse

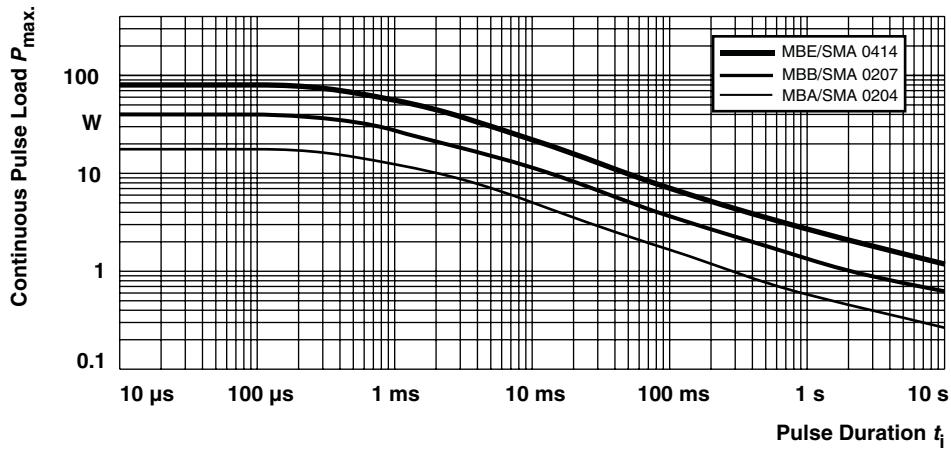

Continuous Pulse

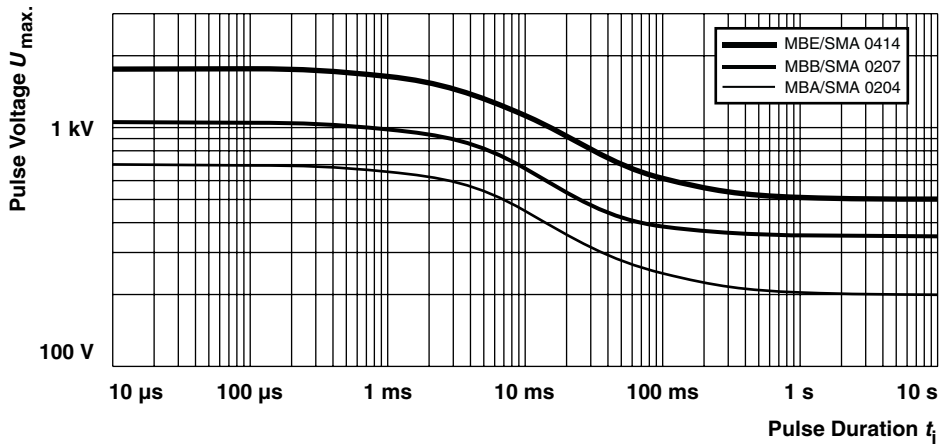

Pulse Voltage



MBA/SMA 0204, MBB/SMA 0207, MBE/SMA 0414 - Professional

Professional Thin Film Leaded Resistors

Vishay Beyschlag

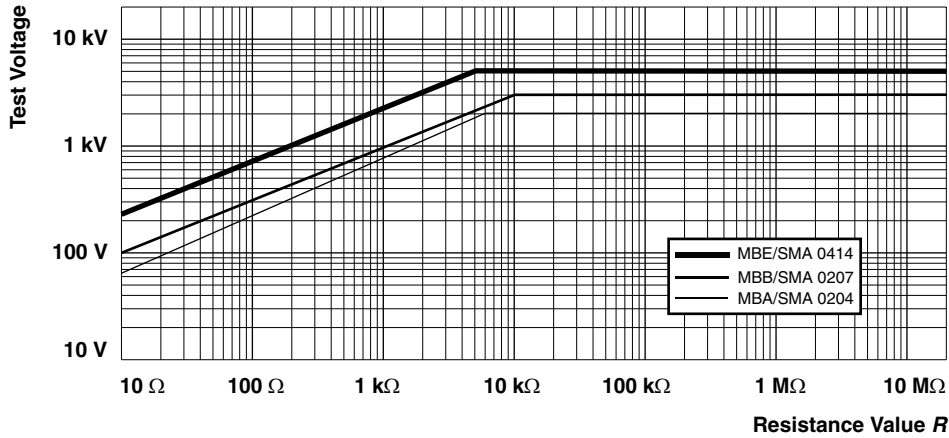

Pulse load rating in accordance with IEC 60115-1, 4.27; 1.2 μs/50 μs; 5 pulses at 12 s intervals; for permissible resistance change 0.5 %.

1.2/50 Pulse

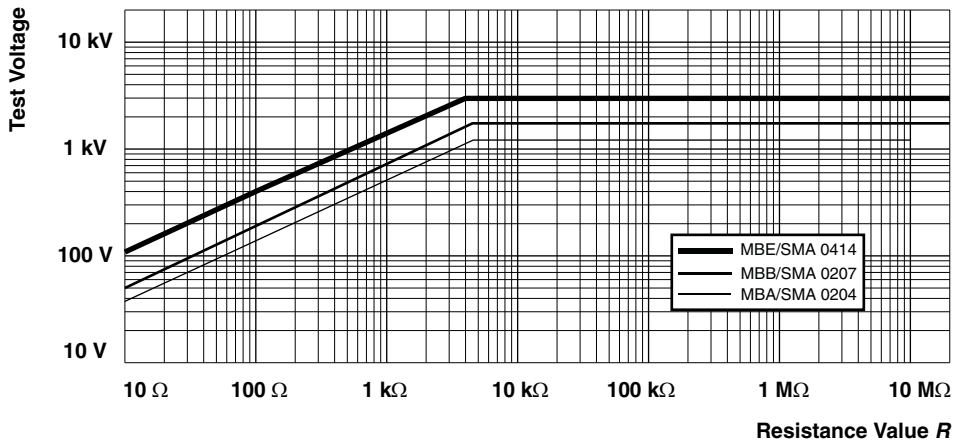

Pulse load rating in accordance with IEC 60115-1, 4.27; 10 μs/700 μs; 10 pulses at 1 minute intervals; for permissible resistance change 0.5 %.

10/700 Pulse

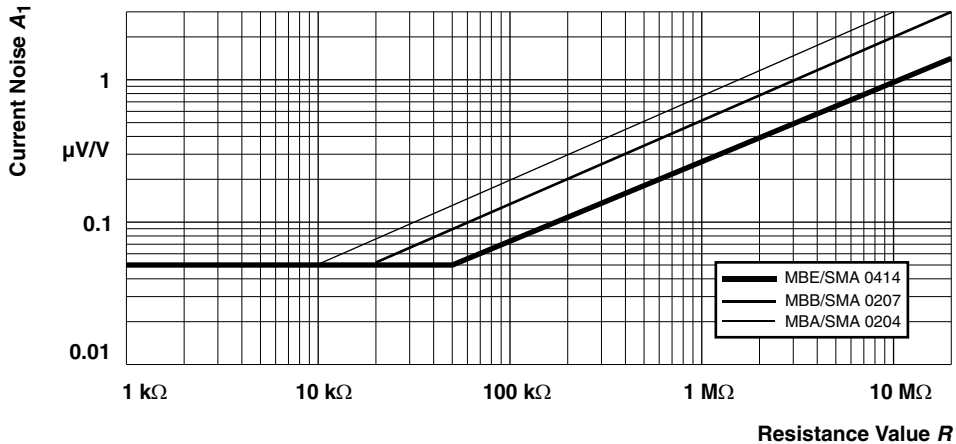

Current noise - A_1 in accordance with IEC 60195

TESTS AND REQUIREMENTS

Essentially all tests are carried out in accordance with the following specifications:

EN 60115-1, generic specification (includes tests)

EN 140100, sectional specification (includes schedule for qualification approval)

CECC 40101-806, detail specification (includes schedule for conformance inspection)

The Test and Requirements table contains only the most important tests. For the full test schedule refer to the documents listed above. The testing also covers most of the requirements specified by EIA/IS-703 and JIS-C-5202.

The tests are carried out in accordance with IEC 60068-2-xx test method and under standard atmospheric conditions in accordance with IEC 60068-1, 5.3. Climatic category LCT/UCT/56 (rated temperature range: Lower Category

Temperature, Upper Category Temperature; damp heat, long term, 56 days) is valid.

Unless otherwise specified the following values apply:

Temperature: 15 °C to 35 °C

Relative humidity: 45 % to 75 %

Air pressure: 86 kPa to 106 kPa (860 mbar to 1060 mbar).

For performing some of the tests, the components are mounted on a test board in accordance with IEC 60115-1, 4.31.

In Test Procedures and Requirements table, only the tests and requirements are listed with reference to the relevant clauses of IEC 60115-1 and IEC 60068-2-xx test methods. A short description of the test procedure is also given.

TEST PROCEDURES AND REQUIREMENTS						
IEC 60115-1 CLAUSE	IEC 60068-2-TEST METHOD	TEST	PROCEDURE	REQUIREMENTS PERMISSIBLE CHANGE (ΔR max.)		
			Stability for product types:	STABILITY CLASS 0.5	STABILITY CLASS 1	STABILITY CLASS 2
			MBA/SMA 0204	1 Ω to 332 k Ω	0.22 Ω to < 1 Ω	> 332 k Ω
			MBB/SMA 0207	1 Ω to 1 M Ω	0.22 Ω to < 1 Ω	> 1 M Ω
			MBE/SMA 0414	1 Ω to 2.4 M Ω	0.22 Ω to < 1 Ω	> 2.4 M Ω
4.5	-	Resistance		$\pm 5 \% R$; $\pm 1 \% R$; $\pm 0.5 \% R$		
4.8	-	Temperature coefficient	At (20/LCT/20) °C and (20/UCT/20) °C	± 50 ppm/K; ± 25 ppm/K		
4.25.1	-	Endurance at 70 °C: Standard operation mode	$U = \sqrt{P_{70} \times R}$ or $U = U_{max.}$; 1.5 h ON; 0.5 h OFF			
			70 °C; 1000 h	$\pm (0.5 \% R + 0.05 \Omega)$	$\pm (0.5 \% R + 0.05 \Omega)$	$\pm 0.5 \% R$
		70 °C; 8000 h	$\pm (1 \% R + 0.05 \Omega)$	$\pm (1 \% R + 0.05 \Omega)$	$\pm 1 \% R$	
	-	Endurance at 70 °C: Long term operation mode	$U = \sqrt{P_{70} \times R}$ or $U = U_{max.}$; 1.5 h ON; 0.5 h OFF			
70 °C; 1000 h			$\pm (0.25 \% R + 0.05 \Omega)$	$\pm (0.25 \% R + 0.05 \Omega)$	$\pm 0.25 \% R$	
		70 °C; 8000 h	$\pm (0.5 \% R + 0.05 \Omega)$	$\pm (0.5 \% R + 0.05 \Omega)$	$\pm 0.5 \% R$	
4.25.3	-	Endurance at upper category temperature	125 °C; 1000 h	$\pm (0.25 \% R + 0.05 \Omega)$	$\pm (0.5 \% R + 0.05 \Omega)$	$\pm 1 \% R$
			155 °C; 1000 h	$\pm (0.5 \% R + 0.05 \Omega)$	$\pm (1 \% R + 0.05 \Omega)$	$\pm 2 \% R$
4.24	78 (Cab)	Damp heat, steady state	(40 \pm 2) °C; 56 days; (93 \pm 3) % RH	$\pm (0.5 \% R + 0.05 \Omega)$	$\pm (1 \% R + 0.05 \Omega)$	$\pm 2 \% R$



TEST PROCEDURES AND REQUIREMENTS						
IEC 60115-1 CLAUSE	IEC 60068-2- TEST METHOD	TEST	PROCEDURE	REQUIREMENTS PERMISSIBLE CHANGE (ΔR max.)		
			Stability for product types:	STABILITY CLASS 0.5	STABILITY CLASS 1	STABILITY CLASS 2
			MBA/SMA 0204	1 Ω to 332 k Ω	0.22 Ω to < 1 Ω	> 332 k Ω
			MBB/SMA 0207	1 Ω to 1 M Ω	0.22 Ω to < 1 Ω	> 1 M Ω
			MBE/SMA 0414	1 Ω to 2.4 M Ω	0.22 Ω to < 1 Ω	> 2.4 M Ω
4.23		Climatic sequence:				
4.23.2	2 (Ba)	Dry heat	155 °C; 16 h			
4.23.3	30 (Db)	Damp heat, cyclic	55 °C; 24 h; 90 % to 100 % RH; 1 cycle			
4.23.4	1 (Aa)	Cold	- 55 °C; 2 h			
4.23.5	13 (M)	Low air pressure	8.5 kPa; 2 h; 15 °C to 35 °C			
4.23.6	30 (Db)	Damp heat, cyclic	55 °C; 5 days; 95 % to 100 % RH; 5 cycles	$\pm (0.5 \% R + 0.05 \Omega)$ no visible damage	$\pm (1 \% R + 0.05 \Omega)$ no visible damage	$\pm 2 \% R$ no visible damage
4.13	-	Short time overload	Room temperature; $U = 2.5 \times \sqrt{P_{70}} \times R$ or $U = 2 \times U_{max}$; 5 s	$\pm (0.1 \% R + 0.01 \Omega)$ no visible damage	$\pm (0.25 \% R + 0.05 \Omega)$ no visible damage	$\pm 0.5 \% R$ no visible damage
4.19	14 (Na)	Rapid change of temperature	30 min at LCT = - 55 °C 30 min at UCT= 155 °C 5 cycles	$\pm (0.1 \% R + 0.01 \Omega)$	$\pm (0.25 \% R + 0.05 \Omega)$	$\pm 0.5 \% R$
			MBA/SMA 0204: 500 cycles MBB/SMA 0207: 200 cycles MBE/SMA 0414: 100 cycles	$\pm (0.5 \% R + 0.05 \Omega)$	$\pm (0.5 \% R + 0.05 \Omega)$	$\pm (0.5 \% R + 0.05 \Omega)$
4.29	45 (XA)	Component solvent resistance	Isopropyl alcohol + 23 °C; toothbrush method	Marking legible; no visible damage		
4.18.2	20 (Tb)	Resistance to soldering heat	Unmounted components; (260 \pm 3) °C; (10 \pm 1) s	$\pm (0.1 \% R + 0.01 \Omega)$ no visible damage	$\pm (0.25 \% R + 0.05 \Omega)$ no visible damage	$\pm 0.5 \% R$ no visible damage
4.17	20 (Ta)	Solderability	+ 235 °C; 2 s solder bath method; SnPb40	Good tinning (> 95 % covered, no visible damage)		
			+ 245 °C; 3 s solder bath method; SnAg3Cu0.5			
4.22	6 (B4)	Vibration	6 h; 10 Hz to 2000 Hz 1.5 mm or 196 m/s ²	$\pm (0.1 \% R + 0.01 \Omega)$	$\pm (0.25 \% R + 0.05 \Omega)$	$\pm 0.5 \% R$
4.16	21 (Ua ₁) 21 (Ub) 21 (Uc)	Robustness of terminations	Tensile, bending and torsion	$\pm (0.1 \% R + 0.01 \Omega)$	$\pm (0.25 \% R + 0.05 \Omega)$	$\pm 0.5 \% R$
4.7	-	Voltage proof	$U_{RMS} = U_{ins}$; 60 s	No flashover or breakdown		
4.40	-	Electrostatic discharge (human body model)	IEC 61340-3-1; 3 pos. + 3 neg. MBA/SMA 0204: 2 kV MBB/SMA 0207: 4 kV MBE/SMA 0414: 6 kV	$\pm (0.5 \% R + 0.05 \Omega)$		



12NC CODE FOR HISTORICAL CODING REFERENCE OF MBA 0204/MBB 0207/MBE 0414							
DESCRIPTION			2312				
			AMMOPACK		REEL		
TYPE	TCR	TOL.	C1 1000 units	CT 5000 units	R1 1000 units	R2 2500 units	RP 5000 units
MBA 0204	± 50 ppm/K	± 5 %	900 3....	905 3....	700 3....	-	805 3....
		± 1 %	900 1....	905 1....	700 1....	-	805 1....
		± 0.5 %	900 5....	905 5....	700 5....	-	805 5....
	± 25 ppm/K	± 1 %	901 1....	906 1....	701 1....	-	806 1....
		± 0.5 %	901 5....	906 5....	701 5....	-	806 5....
	Jumper	-	900 90001	905 90001	700 90001	-	805 90001
MBB 0207	± 50 ppm/K	± 5 %	910 3....	915 3....	710 3....	-	815 3....
		± 1 %	910 1....	915 1....	710 1....	-	815 1....
		± 0.5 %	910 5....	915 5....	710 5....	-	815 5....
	± 25 ppm/K	± 1 %	911 1....	916 1....	711 1....	-	816 1....
		± 0.5 %	911 5....	916 5....	711 5....	-	816 5....
	Jumper	-	910 90001	915 90001	710 90001	-	815 90001
MBE 0414	± 50 ppm/K	± 5 %	920 3....	-	-	825 3....	-
		± 1 %	920 1....	-	-	825 1....	-
		± 0.5 %	920 5....	-	-	825 5....	-
	± 25 ppm/K	± 1 %	921 1....	-	-	826 1....	-
		± 0.5 %	921 5....	-	-	826 5....	-

12NC INFORMATION

- The resistors have a 12-digit numeric code starting with 2312
- The subsequent 4 digits indicate the resistor type, specification and packaging; see the 12NC table
- The remaining 4 digits indicate the resistance value:
 - The first 3 digits indicate the resistance value
 - The last digit indicates the resistance decade in accordance with resistance decade table shown below

Last Digit of 12NC Indicating Resistance Decade

RESISTANCE DECADE	LAST DIGIT
0.1 Ω to 0.999 Ω	7
1 Ω to 9.99 Ω	8
10 Ω to 99.9 Ω	9
100 Ω to 999 Ω	1
1 kΩ to 9.99 kΩ	2
10 kΩ to 99.9 kΩ	3
100 kΩ to 999 kΩ	4
1 MΩ to 9.99 MΩ	5
10 MΩ to 99.9 MΩ	6

12NC Example (for Historical Coding reference of MBA 0204/MBB 0207/MBE 0414)

The 12NC code of a MBA 0204 resistor, value 47.5 kΩ and TCR 50 with ± 1 % tolerance, supplied on bandolier in a box of 5000 units is: 2312 905 14753.



Disclaimer

All product specifications and data are subject to change without notice.

Vishay Intertechnology, Inc., its affiliates, agents, and employees, and all persons acting on its or their behalf (collectively, "Vishay"), disclaim any and all liability for any errors, inaccuracies or incompleteness contained herein or in any other disclosure relating to any product.

Vishay disclaims any and all liability arising out of the use or application of any product described herein or of any information provided herein to the maximum extent permitted by law. The product specifications do not expand or otherwise modify Vishay's terms and conditions of purchase, including but not limited to the warranty expressed therein, which apply to these products.

No license, express or implied, by estoppel or otherwise, to any intellectual property rights is granted by this document or by any conduct of Vishay.

The products shown herein are not designed for use in medical, life-saving, or life-sustaining applications unless otherwise expressly indicated. Customers using or selling Vishay products not expressly indicated for use in such applications do so entirely at their own risk and agree to fully indemnify Vishay for any damages arising or resulting from such use or sale. Please contact authorized Vishay personnel to obtain written terms and conditions regarding products designed for such applications.

Product names and markings noted herein may be trademarks of their respective owners.