

DATA SHEET

**MBA 0204; MBB 0207;
MBE 0414
Professional leaded resistors**

Product specification
Supersedes data of 6th September 2000
File under BCcomponents, BC08

2002 Oct 07

Professional leaded resistors **MBA 0204; MBB 0207; MBE 0414**

FEATURES

- Advanced thin film technology
- Power dissipation rating up to 1 W
- Excellent overall stability: class 0,25
- Wide professional range: 0,22 Ω to 22 M Ω
- Green product, supports lead-free soldering.

Sizes

DIN:	0204	0207	0414
CECC:	A	B	D

APPLICATIONS

- Industrial
- Telecommunication
- Medical equipment.

DESCRIPTION

MBA 0204, MBB 0207 and MBE 0414 professional leaded thin film resistors are the general purpose resistor for all fields of professional electronics where reliability and stability is of major concern. Typical applications include industrial, telecommunication and medical equipment.

Production is strictly controlled and follows an extensive set of instructions established for reproducibility. A homogeneous film of metal alloy is deposited on a high grade ceramic body (85% Al₂O₃) and conditioned to achieve the desired temperature coefficient. Nickel plated steel termination caps are firmly pressed on the metallised rods. A special laser is used to achieve the target value by smoothly cutting a helical groove in the resistive layer without damaging the ceramics. Connecting wires of electrolytic copper plated with 100% pure tin are welded to the termination caps. The resistor elements are covered by a

light blue protective coating designed for electrical, mechanical and climatic protection. Four or five colour code rings designate the resistance value and tolerance in accordance with **IEC 60062**.

The result of the determined production is verified by an extensive testing procedure performed on 100% of the individual resistors. Only accepted products are stuck directly on the adhesive tapes in accordance with **IEC 60286-1**.

The resistors are suitable for processing on automatic insertion equipment and cutting and bending machines. Excellent solderability is proven, even after extended storage. They are suitable for automatic soldering using wave or dipping. The encapsulation is resistant to all cleaning solvents commonly used in the electronics industry, including alcohols, esters and aqueous solutions.

The resistors are completely lead-free, the pure tin plating provides compatibility with lead-free soldering processes. The immunity of the plating against tin whisker growth has been proven under extensive testing. All products comply with the CEFIC-EECA-EICTA list of legal restrictions on hazardous substances.

The resistors are tested in accordance with **CECC 40101-806** which refers to **EN 60115-1** and **EN 140100**. Approval of conformity is indicated by the CECC logo on the package label.

BCcomponents BEYSCHLAG has achieved "**Approval of Manufacturer**" in accordance with **EN 100114-1**.

This product family of leaded thin film resistors for professional applications is complemented by **Zero Ohm Jumpers** and **isolators**.

On request, resistors are available with established reliability in accordance with **CECC 40101-806 Version E**. Please refer to the special data sheet for information on failure rate level, available resistance ranges and ordering codes.

Professional leaded resistors**MBA 0204; MBB 0207;
MBE 0414****QUICK REFERENCE DATA**

DESCRIPTION	MBA 0204		MBB 0207		MBE 0414	
CECC size	A		B		D	
Resistance range	0,22 Ω to 10 M Ω		0,22 Ω to 22 M Ω		0,22 Ω to 22 M Ω	
Resistance tolerance	$\pm 5\%$; $\pm 1\%$; $\pm 0,5\%$					
Temperature coefficient	± 50 ppm/K; ± 25 ppm/K					
Operation mode	long term	standard	long term	standard	long term	standard
Climatic category (LCT/UCT/days)	55/125/56	55/155/56	55/125/56	55/155/56	55/125/56	55/155/56
Rated dissipation, P_{70}	0,25 W	0,4 W	0,4 W	0,6 W	0,65 W	1,0 W
Operating voltage, U_{\max} AC/DC	200 V		300 V ⁽¹⁾		500 V	
Film temperature	125 $^{\circ}$ C	155 $^{\circ}$ C	125 $^{\circ}$ C	155 $^{\circ}$ C	125 $^{\circ}$ C	155 $^{\circ}$ C
Max. resistance change at P_{70} for resistance range, $\Delta R/R$ max., after:	1 Ω to 332 k Ω		1 Ω to 1 M Ω		1 Ω to 2,4 M Ω	
1 000 h	$\leq 0,25\%$	$\leq 0,5\%$	$\leq 0,25\%$	$\leq 0,5\%$	$\leq 0,2\%$	$\leq 0,4\%$
8 000 h	$\leq 0,5\%$	$\leq 1,0\%$	$\leq 0,5\%$	$\leq 1,0\%$	$\leq 0,4\%$	$\leq 0,8\%$
225 000 h	$\leq 1,5\%$	–	$\leq 1,5\%$	–	$\leq 1,2\%$	–
Specified lifetime	225 000 h	8 000 h	225 000 h	8 000 h	225 000 h	8 000 h
Permissible voltage against ambient:						
1 minute	300 V		500 V		800 V	
continuous	75 V		75 V		75 V	
Failure rate	$\leq 0,7 \times 10^{-9}/h$		$\leq 0,3 \times 10^{-9}/h$		$\leq 0,1 \times 10^{-9}/h$	

Note

1. 350 V for 1 000 h.

Professional leaded resistors**MBA 0204; MBB 0207;
MBE 0414****Table 1** Temperature coefficient and resistance range

DESCRIPTION		RESISTANCE VALUE ^(1.)		
T.C.	TOLERANCE	MBA 0204	MBB 0207	MBE 0414
±50 ppm/K	±5%	0,22 Ω to 0,91 Ω	0,22 Ω to 0,91 Ω 11 MΩ to 22 MΩ	0,22 Ω to 0,91 Ω
	±1%	1 Ω to 10 MΩ	1 Ω to 10 MΩ	1 Ω to 22 MΩ
	±0,5%	10 Ω to 475 kΩ	10 Ω to 1 MΩ	10 Ω to 2,4 MΩ
±25 ppm/K	±1%	10 Ω to 475 kΩ	10 Ω to 1 MΩ	10 Ω to 2,4 MΩ
	±0,5%	10 Ω to 475 kΩ	10 Ω to 1 MΩ	10 Ω to 2,4 MΩ
Jumper	–	≤ 10 mΩ; $I_{\max} = 3,0$ A	≤ 10 mΩ, $I_{\max} = 5,0$ A	–

Note

1. Resistance value to be selected from E24 series for ±5% tolerance, from E24/E96 series for ±1% tolerance and from E24/E192 for ±0,5% tolerance.

Resistance ranges printed in bold are preferred T.C. / tolerance combinations with optimized availability.

Professional leaded resistors

**MBA 0204; MBB 0207;
MBE 0414**

ORDERING INFORMATION

Components may be ordered by using either a simple clear text ordering code, see "Type description and ordering code" or BCcomponents' unique 12NC.

Numeric Ordering code (12NC)

- The resistors have a 12-digit ordering code starting with 2312.
- The subsequent 4 digits indicate the resistor type, specification and packaging; see Table 2.
- The remaining 4 digits indicate the resistance value:
 - The first 3 digits indicate the resistance value.
 - The last digit indicates the resistance decade in accordance with Table 3.

Table 2 12NC ordering code indicating resistor type and packaging

DESCRIPTION			ORDERING CODE 2312	
			BANDOLIER IN BOX	
TYPE	T.C.	TOL.	C1 1 000 units	CT 5 000 units
MBA 0204	±50 ppm/K	±5%	900 3....	905 3....
		±1%	900 1....	905 1....
		±0,5%	900 5....	905 5....
	±25 ppm/K	±1%	901 1....	906 1....
		±0,5%	901 5....	906 5....
	jumper	–	900 90001	905 90001
MBB 0207	±50 ppm/K	±5%	910 3....	915 3....
		±1%	910 1....	915 1....
		±0,5%	910 5....	915 5....
	±25 ppm/K	±1%	911 1....	916 1....
		±0,5%	911 5....	916 5....
	jumper	–	910 90001	915 90001
MBE 0414	±50 ppm/K	±5%	920 3....	–
		±1%	920 1....	–
		±0,5%	920 5....	–
	±25 ppm/K	±1%	921 1....	–
		±0,5%	921 5....	–

Resistance ranges printed in bold are preferred T.C. / tolerance combinations with optimized availability.

Professional leaded resistors

**MBA 0204; MBB 0207;
MBE 0414**

Table 3 Last digit of 12NC indicating resistance decade

RESISTANCE DECADE	LAST DIGIT
0,1 Ω to 0,999 Ω	7
1 Ω to 9,99 Ω	8
10 Ω to 99,9 Ω	9
100 Ω to 999 Ω	1
1 k Ω to 9,99 k Ω	2
10 k Ω to 99,9 k Ω	3
100 k Ω to 999 k Ω	4
1 M Ω to 9,99 M Ω	5
10 M Ω to 99,9 M Ω	6

ORDERING EXAMPLE

The ordering code of a MBA 0204 resistor, value 47 k Ω and TC 50 with $\pm 1\%$ tolerance, supplied on bandolier in a box of 5 000 units is: 2312 905 14703.

Type description and ordering code

- We recommend that the clear text ordering code is used to minimize the possibility of errors in order handling.

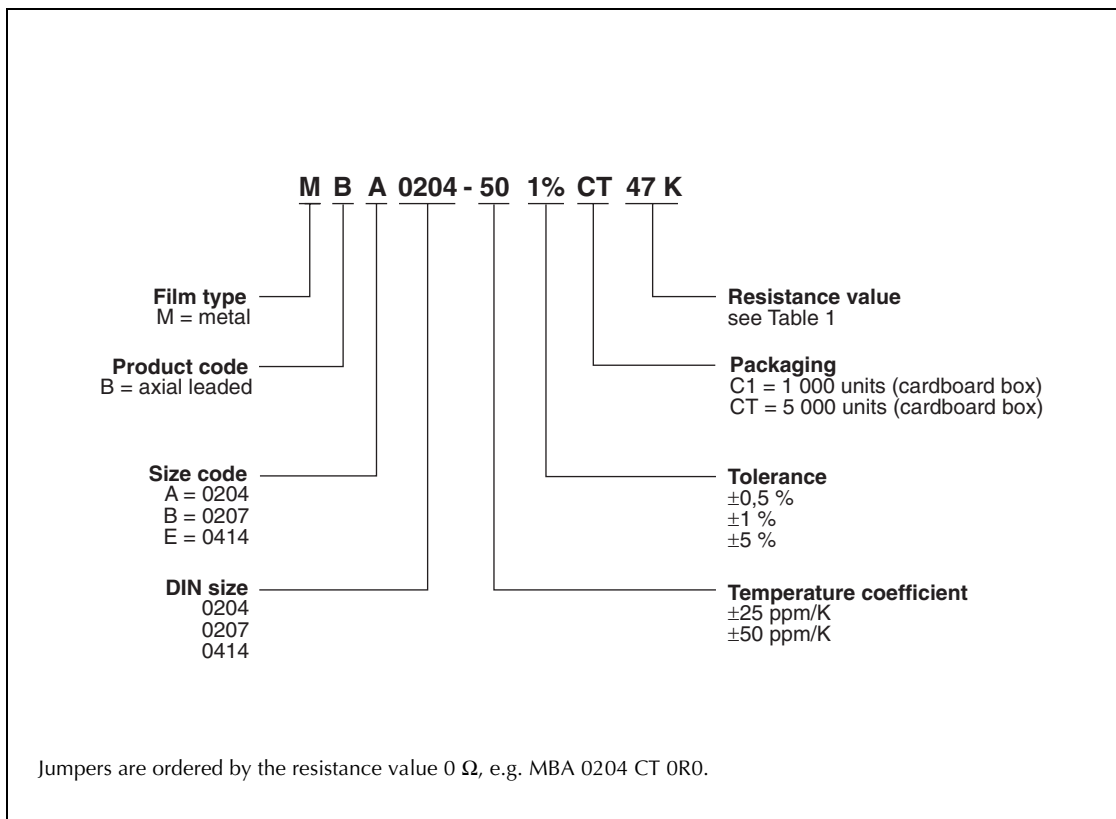

Professional leaded resistors

**MBA 0204; MBB 0207;
MBE 0414**

FUNCTIONAL DESCRIPTION

Derating

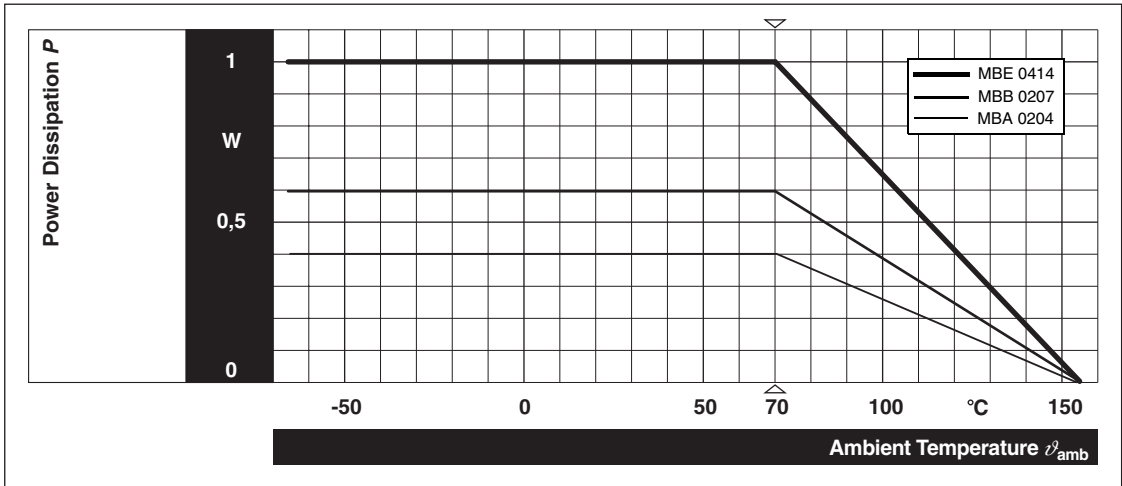

Fig.1 Derating, standard operation.

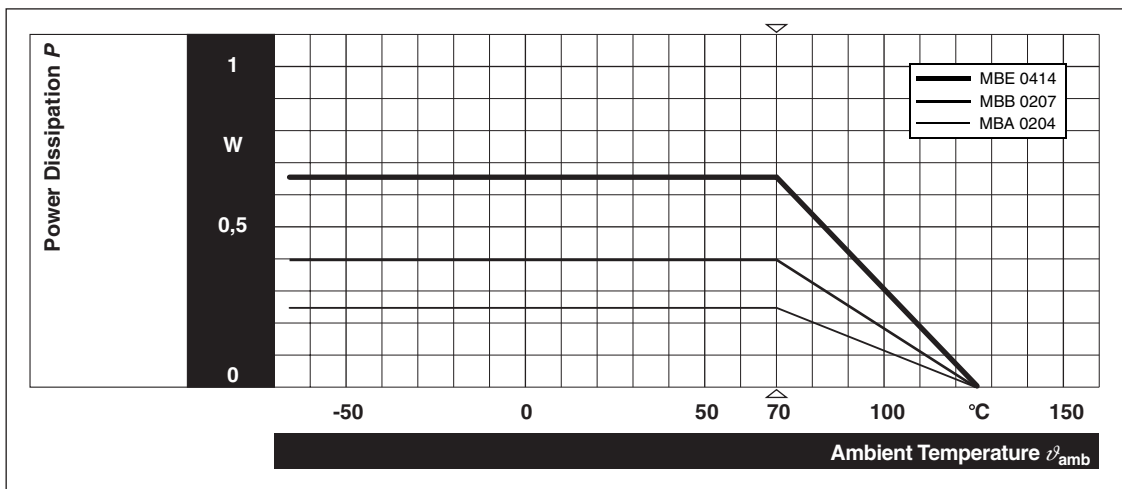

Fig.2 Derating, long term operation.

Professional leaded resistors

**MBA 0204; MBB 0207;
MBE 0414**

Temperature rise

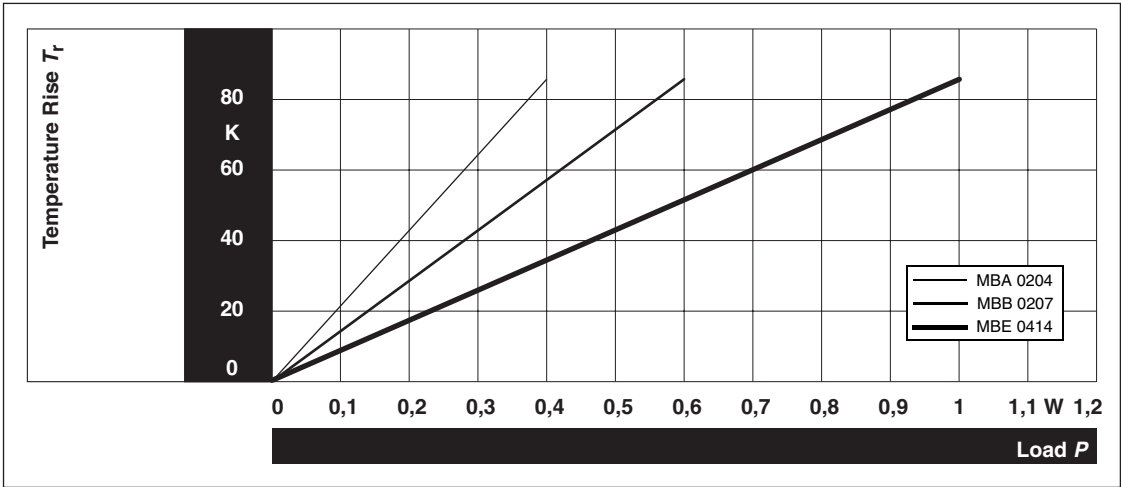

Fig.3 Rise of the surface temperature.

Single pulse

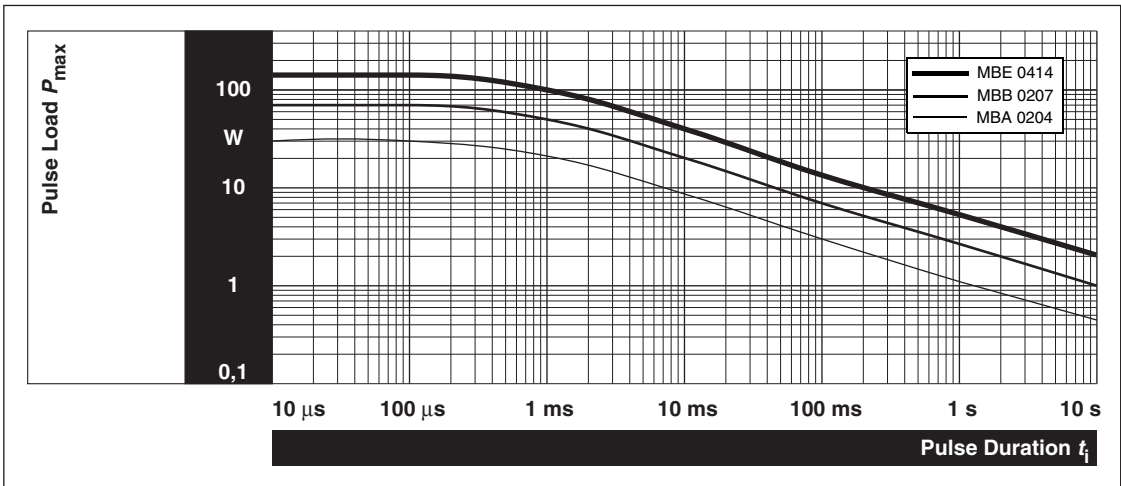

Fig.4 Maximum pulse load, single pulse; for permissible resistance change equivalent to 8000 h operation.

Professional leaded resistors

**MBA 0204; MBB 0207;
MBE 0414**

Continuous pulses

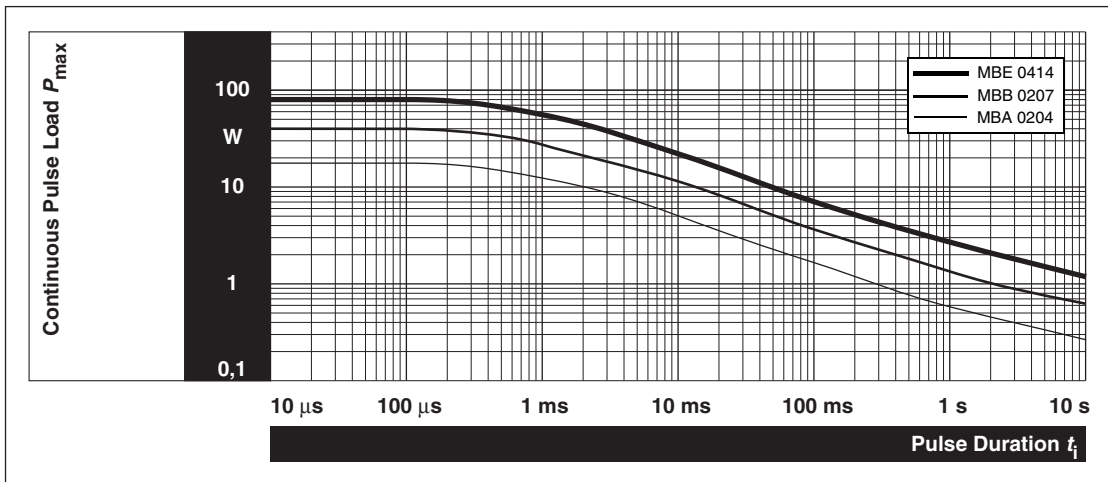

Fig.5 Maximum pulse load, continuous pulses; for permissible resistance change equivalent to 8000 h operation.

Pulse voltage

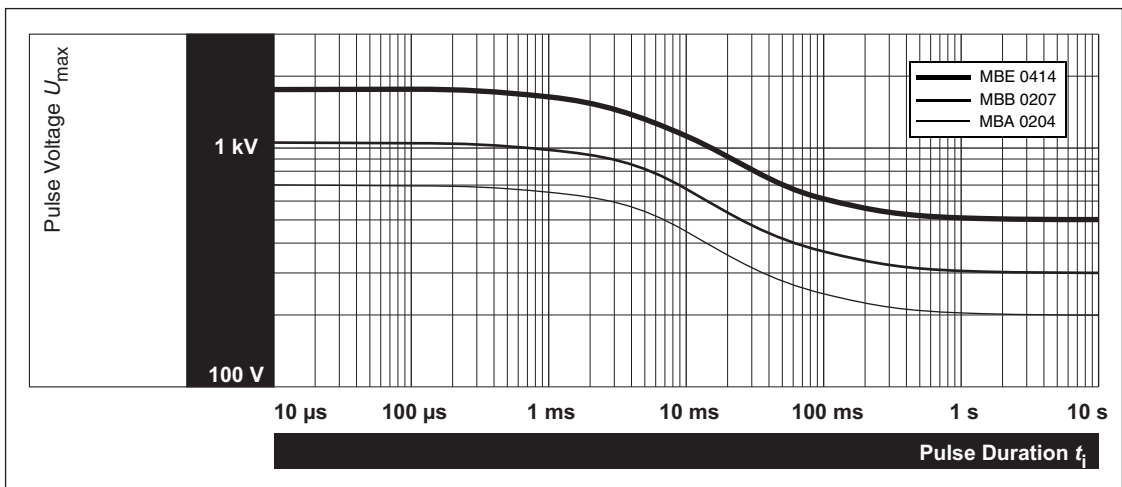

Fig.6 Maximum pulse voltage, single and continuous pulses; for permissible resistance change equivalent to 8000 h operation.

Professional leaded resistors

**MBA 0204; MBB 0207;
MBE 0414**

1,2/50 pulse

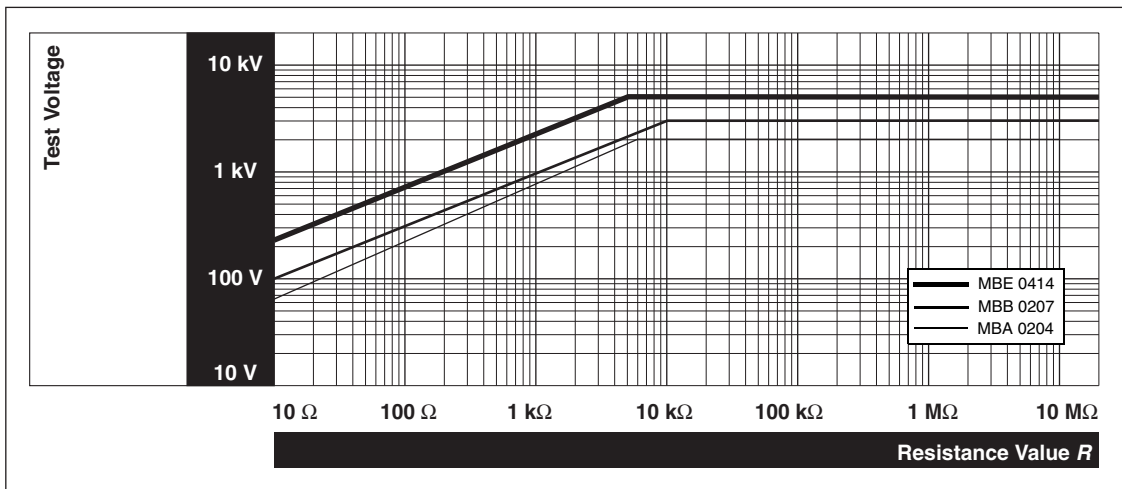

Fig.7 Pulse load rating in accordance with IEC 60115-1, 4.27; 1,2 μs / 50 μs; 5 pulses at 12 s intervals; for permissible resistance change 0,5%.

10/700 pulse

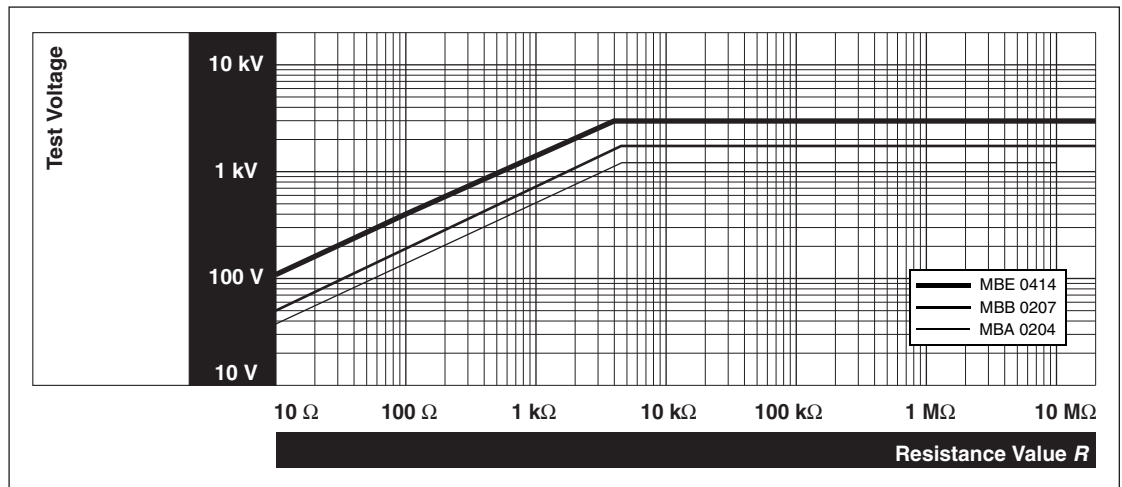
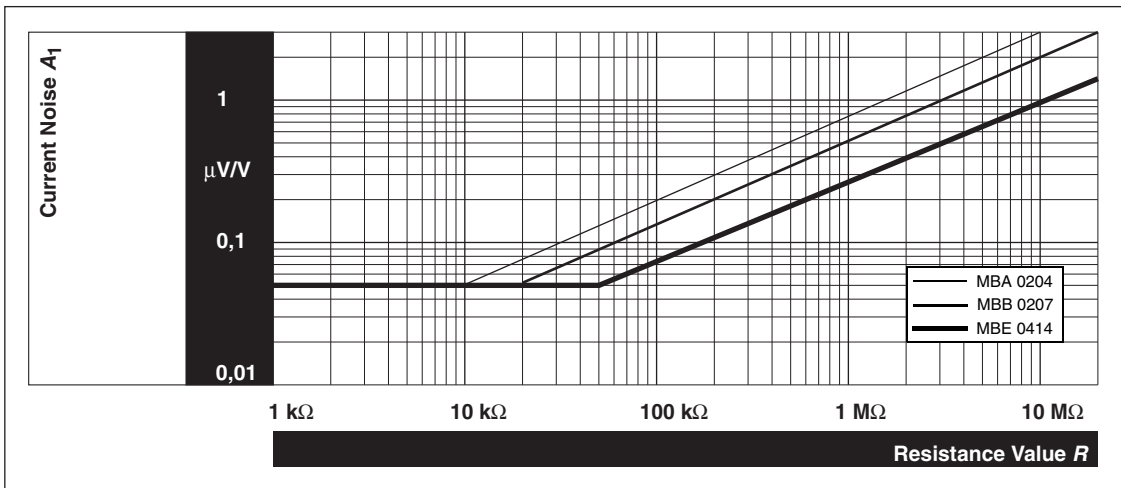

Fig.8 Pulse load rating in accordance with IEC 60115-1, 4.27; 10 μs / 700 μs; 10 pulses at 1 minute intervals; for permissible resistance change 0,5%.

Professional leaded resistors**MBA 0204; MBB 0207;
MBE 0414****Current noise**Fig.9 Current noise A_1 in accordance with IEC 60195.

Professional leaded resistors

**MBA 0204; MBB 0207;
MBE 0414**

MECHANICAL DATA

Outlines

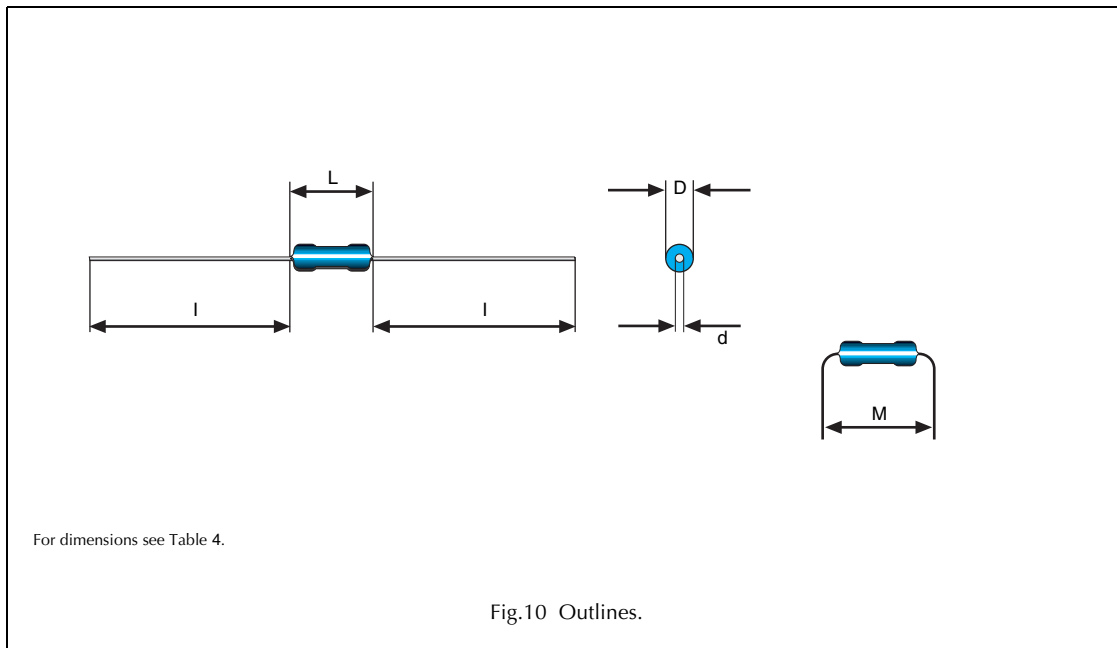

Table 4 Leaded resistor types, mass and relevant physical dimensions; see Fig.10

TYPE	D_{\max} (mm)	L_{\max} (mm)	d_{nom} (mm)	l_{\min} (mm)	M_{\min} (mm)	MASS (mg)
MBA 0204	1,6	3,6	0,5	29,0	5,0	125
MBB 0207	2,5	6,3	0,6	28,0	10,0 ⁽¹⁾	220
MBE 0414	4,0	11,9	0,8	31,0	15,0	700

Note

- For $7,5 \leq M < 10,0$ mm, use version MBB 0207 ... L0 without lacquer on the leads.

Professional leaded resistors

**MBA 0204; MBB 0207;
MBE 0414**

TESTS AND REQUIREMENTS

Essentially all tests are carried out in accordance with the following specifications:

EN 140000 / IEC 60115-1, Generic specification (includes tests)

EN 140100 / IEC 60115-2, Sectional specification (includes schedule for qualification approval)

CECC 40101-806, Detail specification (includes schedule for conformance inspection)

Most of the components are approved in accordance with the European CECC-system, where applicable. Table 5 contains only the most important tests. For the full test schedule refer to the documents listed above. The testing also covers most of the requirements specified by EIA/IS-703 and JIS-C-5202.

The tests are carried out in accordance with IEC 60068 and under standard atmospheric conditions in accordance with IEC 60068-1, 5.3. Climatic category LCT/UCT/56 (rated temperature range: Lower Category Temperature, Upper Category Temperature; damp heat, long term, 56 days) is valid.

Unless otherwise specified the following values apply:

Temperature: 15 °C to 35 °C

Relative humidity: 45% to 75%

Air pressure: 86 kPa to 106 kPa (860 mbar to 1 060 mbar).

For testing the components are mounted on a test board in accordance with IEC 60115-1, 4.31 unless otherwise specified.

In Table 5 only the tests and requirements are listed with reference to the relevant clauses of IEC 60115-1 and IEC 60068-2; a short description of the test procedure is also given.

Table 5 Test procedures and requirements

IEC 60115-1 CLAUSE	IEC 60068-2 TEST METHOD	TEST	PROCEDURE	REQUIREMENTS PERMISSIBLE CHANGE ($\Delta R/R$)		
				STABILITY CLASS 0,5	STABILITY CLASS 1	STABILITY CLASS 2
			stability for product types:			
			MBA 0204	1 Ω to 332 k Ω	0,22 Ω to < 1 Ω	> 332 k Ω
			MBB 0207	1 Ω to 1 M Ω	0,22 Ω to < 1 Ω	> 1 M Ω
			MBE 0414	1 Ω to 2,4 M Ω	0,22 Ω to < 1 Ω	> 2,4 M Ω
4.5	–	resistance		$\pm 5\%$; $\pm 1\%$; $\pm 0,5\%$		
4.8.4.2	–	temperature coefficient	at 20 / LCT / 20 °C and 20 / UCT / 20 °C	± 50 ppm/K; ± 25 ppm/K		
4.25.1	–	endurance at 70 °C: standard operation mode	$U = \sqrt{P_{70} \times R}$ or $U = U_{max}$; 1,5 h on; 0,5 h off 70 °C; 1000 h 70 °C; 8000 h	$\pm(0,5\% + 0,05 \Omega)$ $\pm(1\% + 0,05 \Omega)$	$\pm(0,5\% + 0,05 \Omega)$ $\pm(1\% + 0,05 \Omega)$	$\pm 0,5\%$ $\pm 1\%$
	–	endurance at 70 °C: long term operation mode	$U = \sqrt{P_{70} \times R}$ or $U = U_{max}$; 1,5 h on; 0,5 h off 70 °C; 1000 h 70 °C; 8000 h	$\pm(0,25\% + 0,05 \Omega)$ $\pm(0,5\% + 0,05 \Omega)$	$\pm(0,25\% + 0,05 \Omega)$ $\pm(0,5\% + 0,05 \Omega)$	$\pm 0,25\%$ $\pm 0,5\%$

Professional leaded resistors

MBA 0204; MBB 0207;
MBE 0414

IEC 60115-1 CLAUSE	IEC 60068-2 TEST METHOD	TEST	PROCEDURE	REQUIREMENTS PERMISSIBLE CHANGE ($\Delta R/R$)		
				STABILITY CLASS 0,5	STABILITY CLASS 1	STABILITY CLASS 2
			stability for product types:			
			MBA 0204	1 Ω to 332 k Ω	0,22 Ω to < 1 Ω	> 332 k Ω
			MBB 0207	1 Ω to 1 M Ω	0,22 Ω to < 1 Ω	> 1 M Ω
			MBE 0414	1 Ω to 2,4 M Ω	0,22 Ω to < 1 Ω	> 2,4 M Ω
4.25.3	–	endurance at upper category temperature	125 °C; 1000 h	$\pm(0,25\% + 0,05 \Omega)$	$\pm(0,5\% + 0,05 \Omega)$	$\pm 1\%$
			155 °C; 1000 h	$\pm(0,5\% + 0,05 \Omega)$	$\pm(1\% + 0,05 \Omega)$	$\pm 2\%$
4.24	3 (Ca)	damp heat, steady state	40 ± 2 °C; 56 days; 93 +2/-3% RH	$\pm(0,5\% + 0,05 \Omega)$	$\pm(1\% + 0,05 \Omega)$	$\pm 2\%$
4.23		climatic sequence:				
4.23.2	2 (Ba)	dry heat	155 °C; 16 h			
4.23.3	30 (Db)	damp heat, cyclic	55 °C; 24 h; 90 to 100 % RH; 1 cycle			
4.23.4	1 (Aa)	cold	-55 °C; 2 h			
4.23.5	13 (M)	low air pressure	8,5 kPa; 2 h; 15 to 35 °C			
4.23.6	30 (Db)	damp heat, cyclic	55 °C; 5 days; 95 to 100 % RH; 5 cycles	$\pm(0,5\% + 0,05 \Omega)$ no visible damage	$\pm(1\% + 0,05 \Omega)$ no visible damage	$\pm 2\%$ no visible damage
–	1 (Aa)	cold	-55 °C; 2 h	$\pm(0,1\% + 0,01 \Omega)$	$\pm(0,25\% + 0,05 \Omega)$	$\pm 0,5\%$
4.13	–	short time overload	room temperature; $U = 2,5 \times \sqrt{P_{70}} \times R$ or $U = 2 \times U_{max}$; 5 s	$\pm(0,1\% + 0,01 \Omega)$ no visible damage	$\pm(0,25\% + 0,05 \Omega)$ no visible damage	$\pm 0,5\%$ no visible damage
4.19	14 (Na)	rapid change of temperature	30 minutes at LCT and 30 minutes at UCT; 5 cycles	$\pm(0,1\% + 0,01 \Omega)$ no visible damage	$\pm(0,25\% + 0,05 \Omega)$ no visible damage	$\pm 0,5\%$ no visible damage
4.29	45 (XA)	component solvent resistance	isopropyl alcohol +23 °C; toothbrush method	marking legible; no visible damage		
4.18.2	20 (Tb)	resistance to soldering heat	unmounted components; 260 ± 5 °C; 10 ± 1 s	$\pm(0,1\% + 0,01 \Omega)$ no visible damage	$\pm(0,25\% + 0,05 \Omega)$ no visible damage	$\pm 0,5\%$ no visible damage
4.17	20 (Ta)	solderability	+235 °C; 2 s solder bath method	good tinning ($\geq 95\%$ covered); no visible damage		

Professional leaded resistors**MBA 0204; MBB 0207;
MBE 0414**

IEC 60115-1 CLAUSE	IEC 60068-2 TEST METHOD	TEST	PROCEDURE	REQUIREMENTS PERMISSIBLE CHANGE ($\Delta R/R$)		
4.22	6 (B4)	vibration	6 h; 10 to 2000 Hz 1,5 mm or 196 m/s ²	$\pm(0,1\% + 0,01 \Omega)$	$\pm(0,25\% + 0,05 \Omega)$	$\pm 0,5\%$
4.16	21 (Ua ₁) 21 (Ub) 21 (Uc)	robustness of terminations	tensile, bending and torsion	$\pm(0,1\% + 0,01 \Omega)$	$\pm(0,25\% + 0,05 \Omega)$	$\pm 0,5\%$
4.7	–	voltage proof	$U_{rms} = 100 \text{ V}; 60 \text{ s}$	no flashover or breakdown		

Professional leaded resistors**MBA 0204; MBB 0207;
MBE 0414****ADDITIONAL ORDERING INFORMATION**

- North american part numbers (NAFTA code)

