

# Xtrinsic MAG3110 Three-Axis, Digital Magnetometer

Freescal's MAG3110 is a small, low-power, digital 3-axis magnetometer.

The device can be used in conjunction with a 3-axis accelerometer to realize an orientation independent electronic compass that can provide accurate heading information. It features a standard I<sup>2</sup>C serial interface output and smart embedded functions.

The MAG3110 is capable of measuring magnetic fields with an output data rate (ODR) up to 80 Hz; these output data rates correspond to sample intervals from 12.5 ms to several seconds.

The MAG3110 is available in a plastic DFN package and it is guaranteed to operate over the extended temperature range of -40°C to +85°C.

## Features

- 1.95 V to 3.6 V supply voltage (VDD)
- 1.62 V to VDD IO voltage (VDDIO)
- Ultra small 2 mm x 2 mm x 0.85 mm, 0.4 mm pitch, 10-pin package
- Full-scale range ±1000 μT
- Sensitivity of 0.10 μT
- Noise down to 0.25 μT rms
- Output Data Rates (ODR) up to 80 Hz
- 400 kHz Fast Mode compatible I<sup>2</sup>C interface
- Low-power, single-shot measurement mode
- RoHS compliant

## Applications

- Electronic Compass (e-compass)
- Location-Based Services

## Target markets

- Smartphones, personal navigation devices, robotics, UAVs, speed sensing, current sensing and wrist watches with embedded electronic compasses (e-compass) function.

**Table 1. Ordering information**

Part number	I <sup>2</sup> C Address	Package description	Shipping
MAG3110FCR1	0x0E	DFN-10	Tape and Reel (1000)
FXMS3110CDR1	0x0F	DFN-10	Tape and Reel (1000)

## MAG3110

### Top and Bottom View



**10-PIN DFN**  
**2 mm x 2 mm x 0.85 mm**  
**CASE 2154-02**

### Top View

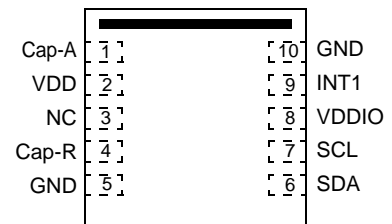

### Pin Connections

## Contents

<b>1</b>	<b>Block diagram and pin description</b> .....	<b>3</b>
1.1	Application circuit .....	4
<b>2</b>	<b>Operating and Electrical Specifications</b> .....	<b>5</b>
2.1	Operating characteristics .....	5
2.2	Absolute maximum ratings .....	6
2.3	Electrical characteristics .....	7
2.4	I <sup>2</sup> C Interface characteristics .....	8
2.5	I <sup>2</sup> C pullup resistor selection .....	9
<b>3</b>	<b>Modes of Operation</b> .....	<b>10</b>
<b>4</b>	<b>Functionality</b> .....	<b>10</b>
4.1	Factory calibration .....	10
4.2	Digital interface .....	10
<b>5</b>	<b>Register Descriptions</b> .....	<b>15</b>
5.1	Sensor Status .....	16
5.2	Device ID .....	18
5.3	User Offset Correction .....	18
5.4	Temperature .....	19
5.5	Control Registers .....	19
<b>6</b>	<b>Geomagnetic Field Maps</b> .....	<b>22</b>
<b>7</b>	<b>PCB Guidelines</b> .....	<b>24</b>
7.1	Overview of Soldering Considerations .....	24
7.2	Halogen Content .....	24
7.3	PCB Mounting Recommendations .....	24

## Related Documentation

The MAG3110 device features and operations are described in a variety of reference manuals, user guides, and application notes. To find the most-current versions of these documents:

1. Go to the Freescale homepage at:

<http://www.freescale.com/>

2. In the Keyword search box at the top of the page, enter the device number MAG3110.
3. In the Refine Your Result pane on the left, click on the Documentation link.

# 1 Block diagram and pin description

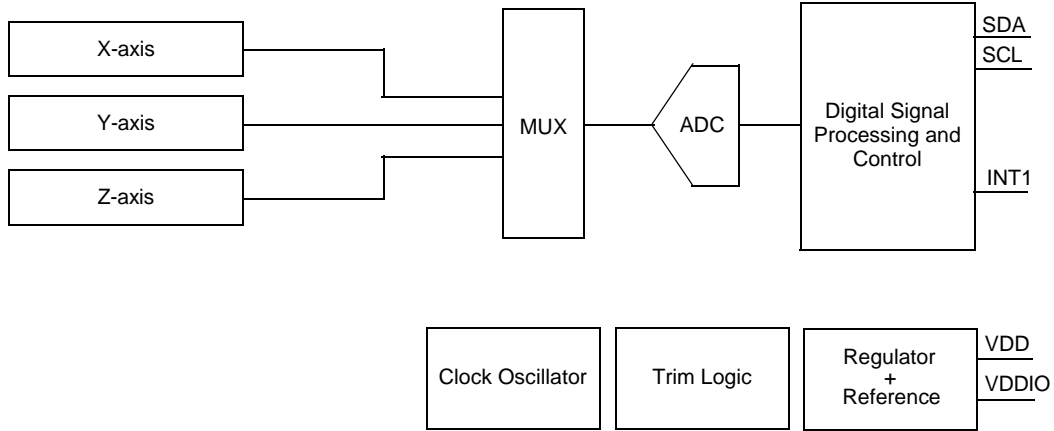

Figure 1. Block diagram

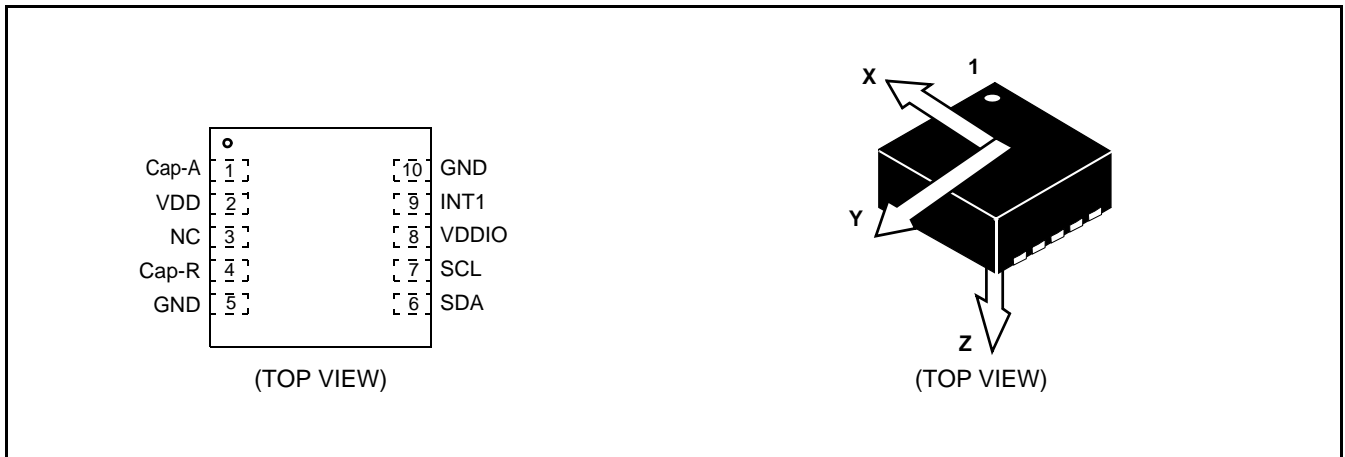

Figure 2. Pin connections and measurement coordinate system



L = WAFER LOT  
 Y = LAST DIGIT OF YEAR  
 W = WORK WEEK

Figure 3. Device marking diagram

**Table 2. Pin descriptions**

Pin	Name	Function
1	Cap-A	Bypass cap for internal regulator
2	VDD	Power supply, 1.95 V – 3.6 V
3	NC	Do not connect
4	Cap-R	Magnetic reset pulse circuit capacitor connection
5	GND	GND
6	SDA	I <sup>2</sup> C Serial Data
7	SCL	I <sup>2</sup> C Serial Clock
8	VDDIO	Digital interface supply, 1.65 V - VDD
9	INT1	Interrupt - active high output
10	GND	GND

## 1.1 Application circuit

Device power is supplied through the VDD line. Power supply decoupling capacitors (100 nF ceramic) should be placed as near as possible to pins 1 and 2 of the device. Additionally a 1  $\mu$ F (or larger) capacitor should be used for bulk decoupling of the VDD supply rail as shown in Figure 4. VDDIO supplies power for the digital I/O pins SCL, SDA, and INT1.

The control signals SCL and SDA, are not tolerant of voltages more than VDDIO + 0.3 volts. If VDDIO is removed, the control signals SCL and SDA will clamp any logic signals through their internal ESD protection diodes.

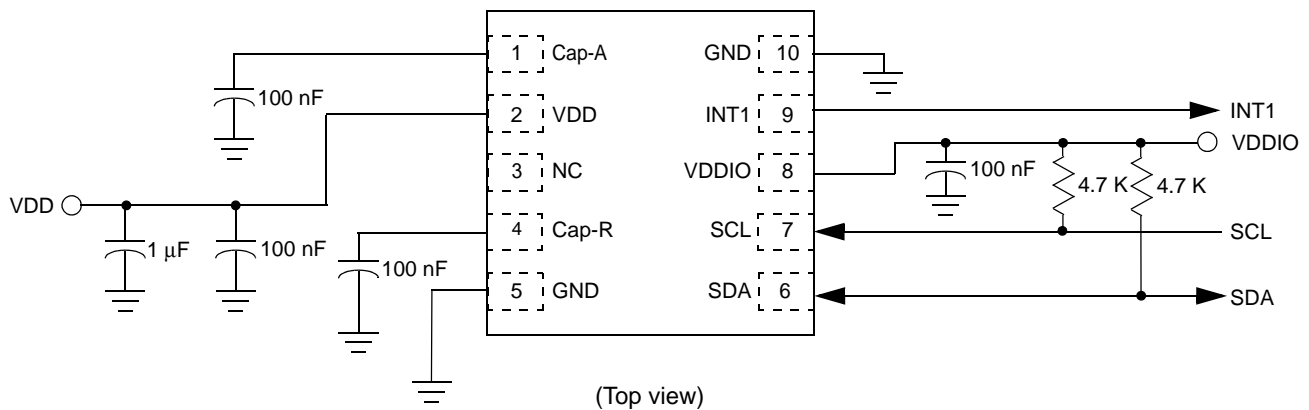

**Figure 4. Electrical connection**

## 2 Operating and Electrical Specifications

### 2.1 Operating characteristics

Table 3. Operating characteristics @ VDD = 2.4 V, VDDIO = 1.8 V, T = 25°C unless otherwise noted.

Parameter	Test Conditions	Symbol	Min	Typ	Max	Unit
Full-scale range		FS		±1000		μT
Output data range <sup>(1)</sup>			-30000		+30000	LSB
Sensitivity		So		0.10		μT/LSB
Sensitivity change versus temperature		Tcs		±0.1		%/°C
Zero-flux offset accuracy				±100		μT
Hysteresis <sup>(2)</sup>				0.25	1	%
Non linearity Best fit straight line <sup>(3)</sup>		NL	-1	±0.3	1	%FS
Magnetometer output noise	OS = 00 <sup>(4)</sup>	Noise		0.4		μT rms
	OS = 01			0.35		
	OS = 10			0.3		
	OS = 11			0.25		
Sensor die-to-package misalignment error (yaw)		D2PE <sub>yaw</sub>		±0.37	±1.36	degrees
Operating temperature range		T <sub>op</sub>	-40		+85	°C

1. Output data range is the sum of ±10000 LSBs full-scale range, ±10000 LSBs user defined offset (provided that CTRL\_REG2[RAW] = 0) and ±10000 zero-flux offset.
2. Hysteresis is measured from 0 μT to 1000 μT to 0 μT and from 0 μT to -1000 μT to 0 μT.
3. Best-fit straight line over the 0 to ±1000 μT full-scale range.
4. OS = Over Sampling Ratio.

## 2.2 Absolute maximum ratings

Stresses above those listed as “absolute maximum ratings” may cause permanent damage to the device. This is a stress rating only and functional operation of the device under these conditions is not implied. Exposure to maximum rating conditions for extended periods may affect device reliability.

**Table 4. Maximum ratings**

Rating	Symbol	Value	Unit
Supply voltage	VDD	-0.3 to +3.6	V
Input voltage on any control pin (SCL, SDA)	V <sub>in</sub>	-0.3 to VDDIO + 0.3	V
Maximum applied magnetic/field	B <sub>MAX</sub>	100,000	μT
Operating temperature range	T <sub>op</sub>	-40 to +85	°C
Storage temperature range	T <sub>STG</sub>	-40 to +125	°C

**Table 5. ESD and latchup protection characteristics**

Rating	Symbol	Value	Unit
Human Body Model	HBM	±2000	V
Machine Model	MM	±200	V
Charge Device Model	CDM	±500	V
Latchup current at T = 85°C	I <sub>LU</sub>	±100	mA



This device is sensitive to mechanical shock. Improper handling can cause permanent damage of the part or cause the part to otherwise fail.



This device is sensitive to ESD, improper handling can cause permanent damage to the part.

## 2.3 Electrical characteristics

**Table 6. Electrical characteristics @ VDD = 2.4 V, VDDIO = 1.8 V, T = 25°C unless otherwise noted**

Parameter	Test Conditions	Symbol	Min	Typ	Max	Unit
Supply voltage		VDD	1.95	2.4	3.6	V
Interface supply voltage		VDDIO	1.62		VDD	V
Supply current in ACTIVE mode	ODR <sup>(1)(2)</sup> 80 Hz, OS <sup>(1)</sup> = 00	I <sub>dd</sub>		900		μA
	ODR 40 Hz, OS <sup>(3)</sup> = 00			550		
	ODR 20 Hz, OS <sup>(3)</sup> = 00			275		
	ODR 10 Hz, OS <sup>(3)</sup> = 00			137.5		
	ODR 5 Hz, OS <sup>(3)</sup> = 00			68.8		
	ODR 2.5 Hz, OS <sup>(3)</sup> = 00			34.4		
	ODR 1.25 Hz, OS <sup>(3)</sup> = 00			17.2		
	ODR 0.63 Hz, OS = 00			8.6		
Supply current drain in STANDBY mode	Measurement mode off	I <sub>ddStby</sub>		2		μA
Digital high level input voltage SCL, SDA		VIH	0.75*VDDIO			V
Digital low level input voltage SCL, SDA		VIL			0.3* VDDIO	V
High level output voltage INT1	I <sub>O</sub> = 500 μA	VOH	0.9*VDDIO			V
Low level output voltage INT1	I <sub>O</sub> = 500 μA	VOL			0.1* VDDIO	V
Low level output voltage SDA	I <sub>O</sub> = 500 μA	VOLS			0.1* VDDIO	V
Output Data Rate (ODR)		ODR	0.8*ODR	ODR	1.2 *ODR	Hz
Signal bandwidth		BW		ODR/2		Hz
Boot time from power applied to boot complete		BT		1.7		ms
Turn-on time <sup>(4)(5)</sup>	CTRL_REG1[OS] = 2'b01	T <sub>on</sub>		25		ms
Operating temperature range		T <sub>op</sub>	-40		+85	°C

1. ODR = Output Data Rate; OS = Over Sampling Ratio.

2. Please see [Table 32](#) for all ODR and OSR setting combinations, as well as corresponding current consumption and noise levels.

3. By design.

4. Time to obtain valid data from STANDBY mode to ACTIVE Mode.

5. In 80 Hz mode ODR.

## 2.4 I<sup>2</sup>C Interface characteristics

Table 7. I<sup>2</sup>C slave timing values<sup>(1)</sup>

Parameter	Symbol	I <sup>2</sup> C Fast Mode		Unit
		Min	Max	
SCL clock frequency Pullup = 1 kΩ, C <sub>b</sub> = 20 pF	f <sub>SCL</sub>	0	400	kHz
Bus free time between STOP and START condition	t <sub>BUF</sub>	1.3		μs
Repeated START hold time	t <sub>HD;STA</sub>	0.6		μs
Repeated START setup time	t <sub>SU;STA</sub>	0.6		μs
STOP condition setup time	t <sub>SU;STO</sub>	0.6		μs
SDA data hold time <sup>(2)</sup>	t <sub>HD;DAT</sub>	0.05 <sup>(3)</sup>	(4)	μs
SDA valid time <sup>(5)</sup>	t <sub>VD;DAT</sub>		0.9 <sup>(4)</sup>	μs
SDA valid acknowledge time <sup>(6)</sup>	t <sub>VD;ACK</sub>		0.9 <sup>(4)</sup>	μs
SDA setup time	t <sub>SU;DAT</sub>	100 <sup>(7)</sup>		ns
SCL clock low time	t <sub>LOW</sub>	1.3		μs
SCL clock high time	t <sub>HIGH</sub>	0.6		μs
SDA and SCL rise time	t <sub>r</sub>	20 + 0.1C <sub>b</sub> <sup>(8)</sup>	1000	ns
SDA and SCL fall time <sup>(3) (8) (9) (10)</sup>	t <sub>f</sub>	20 + 0.1C <sub>b</sub> <sup>(8)</sup>	300	ns
Pulse width of spikes on SDA and SCL that must be suppressed by input filter	t <sub>SP</sub>		50	ns

- All values are referred to VIH (min) and VIL (max) levels.
- t<sub>HD;DAT</sub> is the data hold time that is measured from the falling edge of SCL; the hold time applies to data in transmission and the acknowledge.
- A device must internally provide a hold time of at least 300 ns for the SDA signal (with respect to the VIH (min) of the SCL signal) to bridge the undefined region of the falling edge of SCL.
- The maximum t<sub>HD;DAT</sub> could be must be less than the maximum of t<sub>VD;DAT</sub> or t<sub>VD;ACK</sub> by a transition time. This device may stretch the LOW period (t<sub>LOW</sub>) of the SCL signal.
- t<sub>VD;DAT</sub> = time for Data signal from SCL LOW to SDA output (HIGH or LOW, depending on which one is worse).
- t<sub>VD;ACK</sub> = time for Acknowledgement signal from SCL LOW to SDA output (HIGH or LOW, depending on which one is worse).
- A Fast mode I<sup>2</sup>C device can be used in a Standard mode I<sup>2</sup>C system, but the requirement t<sub>SU;DAT</sub> 250 ns must then be met. This will automatically be the case if the device does not stretch the LOW period of the SCL signal. If such a device does stretch the LOW period of the SCL signal, it must output the next data bit to the SDA line t<sub>r(max)</sub> + t<sub>SU;DAT</sub> = 1000 + 250 = 1250 ns (according to the Standard mode I<sup>2</sup>C specification) before the SCL line is released. Also the acknowledge timing must meet this setup time.
- C<sub>b</sub> = total capacitance of one bus line in pF.
- The maximum t<sub>f</sub> for the SDA and SCL bus lines is specified at 300 ns. The maximum fall time for the SDA output stage t<sub>f</sub> is specified at 250 ns. This allows series protection resistors to be connected in between the SDA and the SCL pins and the SDA/SCL bus lines without exceeding the maximum specified t<sub>f</sub>.
- In Fast mode Plus, fall time is specified the same for both output stage and bus timing. If series resistors are used, designers should allow for this when considering bus timing.



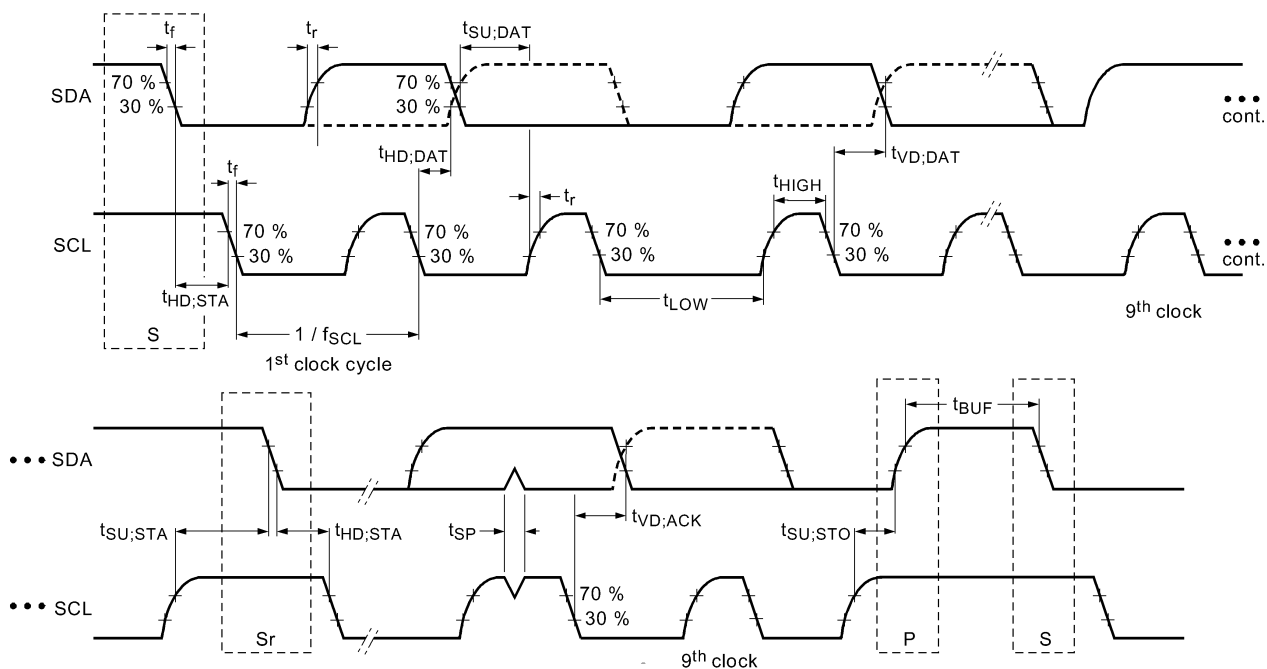

Figure 5. I<sup>2</sup>C slave timing diagram

## 2.5 I<sup>2</sup>C pullup resistor selection

The SCL and SDA signals are driven by open-drain buffers and a pullup resistor is required to make the signals rise to the high state. The value of the pullup resistors depends on the system I<sup>2</sup>C clock rate and the total capacitive load on the I<sup>2</sup>C bus.

Higher resistance pullups will conserve power, at the expense of a slower rise time on the SCL and SDA lines (due to the RC time constant between the bus capacitance and the pullup resistor), and will limit the maximum I<sup>2</sup>C clock frequency that can be achieved.

Lower resistance value pullup resistors consume more power, but enable higher I<sup>2</sup>C clock operating frequencies.

I<sup>2</sup>C bus capacitance consists of the sum of the parasitic device and trace capacitances present. In general, longer bus traces and an increased number of devices lead to higher total bus capacitance and will require lower value pullup resistors to enable a given frequency of operation.

For Standard mode operation, pullup resistor values between 5 k $\Omega$  and 10 k $\Omega$  are recommended as a starting point, but may need to be lowered depending on the number of devices present on the bus and the total bus capacitance. For Fast mode operation, pullup resistor values of 1k (or lower) may be required.

## 3 Modes of Operation

Table 8. Modes of operation description

Mode	I <sup>2</sup> C Bus State	Function Description
STANDBY	I <sup>2</sup> C communication is possible.	Only POR and Digital blocks are enabled, the Analog subsystem is disabled.
ACTIVE	I <sup>2</sup> C communication is possible.	All blocks are enabled (POR, Digital, Analog).

## 4 Functionality

MAG3110 is a small low-power, digital output, 3-axis linear magnetometer packaged in a 10-pin DFN. The device contains a magnetic transducer for sensing and an ASIC for control and digital I<sup>2</sup>C communications.

### 4.1 Factory calibration

MAG3110 is factory calibrated for sensitivity and temperature coefficient of sensitivity. All factory calibration coefficients are automatically applied by the ASIC before a measurement is taken and the result written to registers 0x01 to 0x06 (Section 5, "Register Descriptions," on page 15).

The magnetic offset registers in addresses 0x09 to 0x0E are not a factory calibration offset but allow the user to define a hard-iron offset which can be automatically subtracted from the magnetic field readings (see Section 4.2.4, "User offset corrections," on page 12).

### 4.2 Digital interface

Table 9. Serial interface pin description

Pin name	Pin description
VDDIO	IO voltage
SCL	I <sup>2</sup> C Serial Clock
SDA	I <sup>2</sup> C Serial Data
INT	Data ready interrupt pin

There are two signals associated with the I<sup>2</sup>C bus: the Serial Clock Line (SCL) and the Serial Data line (SDA). External pullup resistors (connected to VDDIO) are needed for SDA and SCL. When the bus is free, both lines are high. The I<sup>2</sup>C interface is compliant with Fast mode (400 kHz), and Normal mode (100 kHz) I<sup>2</sup>C standards.

#### 4.2.1 General I<sup>2</sup>C operation

There are two signals associated with the I<sup>2</sup>C bus: the Serial Clock Line (SCL) and the Serial Data line (SDA). The latter is a bidirectional line used for sending and receiving the data to/from the interface. External pullup resistors connected to VDDIO are required for SDA and SCL. When the bus is free both the lines are high. The I<sup>2</sup>C interface is compliant with fast mode (400 kHz), and normal mode (100 kHz) I<sup>2</sup>C standards. Operation at frequencies higher than 400 kHz is possible, but depends on several factors including the pullup resistor values, and total bus capacitance (trace + device capacitance).

A transaction on the bus is started with a start condition (ST) signal, which is defined as a HIGH-to-LOW transition on the data line while the SCL line is held HIGH. After the ST signal has been transmitted by the master, the bus is considered busy. The next byte of data transmitted contains the slave address in the first seven bits, and the eighth bit, the read/write bit, indicates whether the master is receiving data from the slave or transmitting data to the slave. When an address is sent, each device in the system compares the first seven bits after the ST condition with its own address. If they match, the device considers itself addressed by the master. The 9th clock pulse, following the slave address byte (and each subsequent byte) is the acknowledge (ACK). The transmitter must release the SDA line during the ACK period. The receiver must then pull the data line low so that it remains stable low during the high period of the acknowledge clock period.

The number of bytes per transfer is unlimited. If a receiver can't receive another complete byte of data until it has performed some other function, it can hold the clock line, SCL low to force the transmitter into a wait state. Data transfer only continues when the receiver is ready for another byte and releases the data line. This delay action is called clock stretching. Not all receiver devices support clock stretching. Not all master devices recognize clock stretching. This part supports clock stretching.

## MAG3110

A low to high transition on the SDA line while the SCL line is high is defined as a stop condition (SP) signal. A write or burst write is always terminated by the master issuing the SP signal. A master should properly terminate a read by not acknowledging a byte at the appropriate time in the protocol. A master may also issue a repeated start signal (SR) during a transfer.

The 7-bit I<sup>2</sup>C slave address assigned to MAG3110 is 0x0E (standard); the address assigned to FXMS3110CD is 0x0F (Windows™ 8).

## 4.2.2 I<sup>2</sup>C Read/Write operations

### Single byte read

The master (or MCU) transmits a start condition (ST) to the MAG3110, followed by the slave address, with the R/W bit set to “0” for a write, and the MAG3110 sends an acknowledgement. Then the master (or MCU) transmits the address of the register to read and the MAG3110 sends an acknowledgement. The master (or MCU) transmits a repeated start condition (SR), followed by the slave address with the R/W bit set to “1” for a read from the previously selected register. The MAG3110 then acknowledges and transmits the data from the requested register. The master does not acknowledge (NAK) the transmitted data, but transmits a stop condition to end the data transfer.

### Multiple byte read

When performing a multi-byte or “burst” read, the MAG3110 automatically increments the register address read pointer after a read command is received. Therefore, after following the steps of a single byte read, multiple bytes of data can be read from sequential registers after each MAG3110 acknowledgment (AK) is received until a no acknowledge (NAK) occurs from the master followed by a stop condition (SP) signaling the end of transmission.

### Single byte write

To start a write command, the master transmits a start condition (ST) to the MAG3110, followed by the slave address with the R/W bit set to “0” for a write, and the MAG3110 sends an acknowledgement. Then the master (or MCU) transmits the address of the register to write to, and the MAG3110 sends an acknowledgement. Then the master (or MCU) transmits the 8-bit data to write to the designated register and the MAG3110 sends an acknowledgement that it has received the data. Since this transmission is complete, the master transmits a stop condition (SP) to end the data transfer. The data sent to the MAG3110 is now stored in the appropriate register.

### Multiple byte write

The MAG3110 automatically increments the register address write pointer after a write command is received. Therefore, after following the steps of a single byte write, multiple bytes of data can be written to sequential registers after each MAG3110 acknowledgment (ACK) is received.

**< Single Byte Read >**

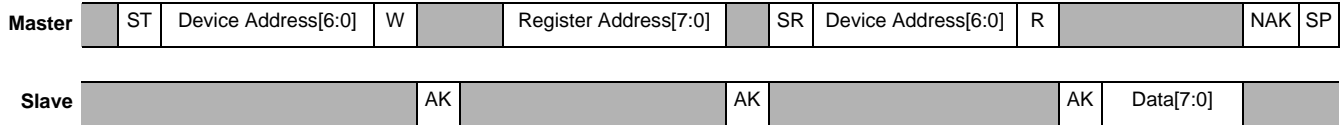

**< Multiple Byte Read >**

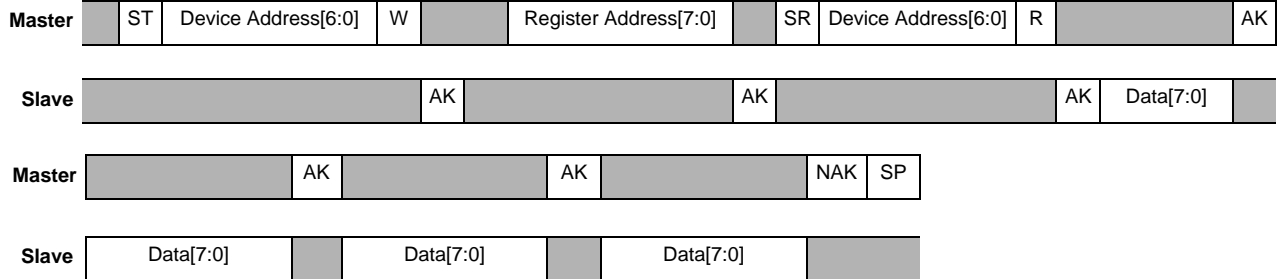

**< Multiple Byte Write >**

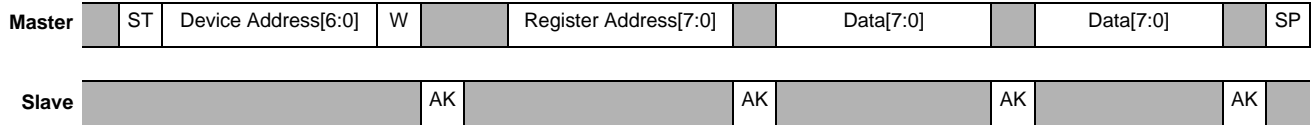

**< Single Byte Write >**

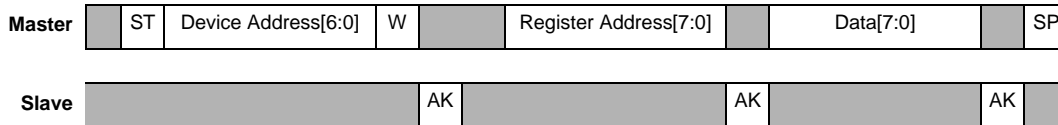

**Legend**

ST: Start Condition      SP: Stop Condition      NAK: No Acknowledge      W: Write = 0  
 SR: Repeated Start Condition      AK: Acknowledge      R: Read = 1

**Figure 6. I<sup>2</sup>C timing diagram**

**4.2.3 Fast Read mode**

When the Fast Read (FR) bit is set (CTRL\_REG1, 0x10, bit 2), the MSB 8-bit data is read through the I<sup>2</sup>C bus. Auto-increment is set to skip over the LSB data. When FR bit is cleared, the complete 16-bit data is read accessing all 6 bytes sequentially (OUT\_X\_MSB, OUT\_X\_LSB, OUT\_Y\_MSB, OUT\_Y\_LSB, OUT\_Z\_MSB, OUT\_Z\_LSB).

**4.2.4 User offset corrections**

The 2's complement user offset correction register values are used to compensate for correcting the X, Y, and Z-axis after device board mount. These values may be used to compensate for hard-iron interference and zero-flux offset of the sensor.

Depending on the setting of the CTRL\_REG2[RAW] bit, the magnetic field sample data is corrected with the user offset values (CTRL\_REG2[RAW] = 0), or can be read out uncorrected for user offset values (CTRL\_REG2[RAW] = 1).

The factory calibration for gain, offset and temperature compensation is always automatically applied irrespective of the setting of the CTRL\_REG2[RAW] bit which only controls whether the user offset correction values stored in the OFF\_X/Y/Z registers are applied to the output data. In order to not saturate the sensor output, user written offset values should be within the range of ±10,000 counts.

## 4.2.5 INT1

The DR\_STATUS register (see [section 5.1.1](#)) contains the ZYXDR bit which denotes the presence of new measurement data on one or more axes. Software polling can be used to detect the transition of the ZYXDR bit from 0 to 1 but, since the ZYXDR bit is also logically connected to the INT1 pin, a more efficient approach is to use INT1 to trigger a software interrupt when new measurement data is available as follows:

1. Enable automatic resets by setting AUTO\_MRST\_EN bit in CTRL\_REG2 (CTRL\_REG2 = 0b1XXXXXX).
2. Put MAG3110 in ACTIVE mode (CTRL\_REG1 = 0bXXXXXX01).
3. Idle until INT1 goes HIGH and activates an interrupt service routine in the user software.
4. Read magnetometer data as required from registers 0x01 to 0x06. INT1 is cleared when register 0x01 OUT\_X\_MSB is read.
5. Return to idle in step 3.

## 4.2.6 Triggered Measurements

Set the TM bit in CTRL\_REG1 when you want the part to acquire only one sample on each axis. See table below for details.

**Table 10.**

AC	TM	Description
0	0	ASIC is in low power standby mode.
0	1	The ASIC will exit standby mode, perform one measurement cycle based on the programmed ODR and OSR setting, update the I <sup>2</sup> C data registers and re- enter standby mode.
1	0	The ASIC will perform continuous measurements based on the current OSR and ODR settings.
1	1	The ASIC will continue the current measurement at the fastest applicable ODR for the user programmed OSR. The ASIC will return back to the programmed ODR after completing the triggered measurement.

The anti-aliasing filter in the A/D converter has a finite delay before the output “settles”. The output data for the first ODR period after getting out of Standby mode is expected to be slightly off. This effect will be more pronounced for the lower over-sampling settings since with higher settings the error of the first acquisition will be averaged over the total number of samples. Therefore, it is not recommended to use TRIGGER MODE (CTRL\_REG1[AC]=0, CTRL\_REG1[TM]=1) measurements for applications that require high accuracy, especially with low over-sampling settings.

## 4.2.7 MAG3110 Setup Examples

### Continuous measurements with ODR = 80 Hz, OSR = 1

1. Enable automatic magnetic sensor resets by setting bit AUTO\_MRST\_EN in CTRL\_REG2. (CTRL\_REG2 = 0x80)
2. Put MAG3110 in active mode 80 Hz ODR with OSR = 1 by writing 0x01 to CTRL\_REG1 (CTRL\_REG1 = 0x01)
3. At this point it is possible to sync with MAG3110 utilizing INT1 pin or using polling of the DR\_STATUS register as explained in [section 4.2.5](#).

### Continuous measurements with ODR = 0.63 Hz, OSR = 2

1. Enable automatic magnetic sensor resets by setting bit AUTO\_MRST\_EN in CTRL\_REG2. (CTRL\_REG2 = 0x80)
2. Put MAG3110 in active mode 0.63 Hz ODR with OSR = 2 by writing 0xC9 to CTRL\_REG1 (CTRL\_REG1 = 0xC9)
3. At this point, it is possible to sync with MAG3110 utilizing INT1 pin or using polling of the DR\_STATUS register as explained in [section 4.2.5](#).

### Triggered measurements with ODR = 10 Hz, OSR = 8

1. Enable automatic magnetic sensor resets by setting bit AUTO\_MRST\_EN in CTRL\_REG2. (CTRL\_REG2 = 0x80)
2. Initiate a triggered measurement with OSR = 128 by writing 0b00011010 to CTRL\_REG1 (CTRL\_REG1 = 0b00011010).
3. MAG3110 will acquire the triggered measurement and go back into STANDBY mode. It is possible at this point to sync on INT1 or resort to polling of DR\_STATUS register to read the acquired data out of MAG3110.
4. Go back to step 2 based on application needs.

## 5 Register Descriptions

Table 11. Register Address Map

Name	Type	Register Address	Auto-Increment Address (Fast Read) <sup>(1)</sup>	Default Value	Comment
DR_STATUS <sup>(2)</sup>	R	0x00	0x01	0000 0000	Data ready status per axis
OUT_X_MSB <sup>(2)</sup>	R	0x01	0x02 (0x03)	data	Bits [15:8] of X measurement
OUT_X_LSB <sup>(2)</sup>	R	0x02	0x03	data	Bits [7:0] of X measurement
OUT_Y_MSB <sup>(2)</sup>	R	0x03	0x04 (0x05)	data	Bits [15:8] of Y measurement
OUT_Y_LSB <sup>(2)</sup>	R	0x04	0x05	data	Bits [7:0] of Y measurement
OUT_Z_MSB <sup>(2)</sup>	R	0x05	0x06 (0x07)	data	Bits [15:8] of Z measurement
OUT_Z_LSB <sup>(2)</sup>	R	0x06	0x07	data	Bits [7:0] of Z measurement
WHO_AM_I <sup>(2)</sup>	R	0x07	0x08	0xC4	Device ID Number
SYSMOD <sup>(2)</sup>	R	0x08	0x09	data	Current System Mode
OFF_X_MSB	R/W	0x09	0x0A	0000 0000	Bits [14:7] of user X offset
OFF_X_LSB	R/W	0x0A	0x0B	0000 0000	Bits [6:0] of user X offset
OFF_Y_MSB	R/W	0x0B	0x0C	0000 0000	Bits [14:7] of user Y offset
OFF_Y_LSB	R/W	0x0C	0x0D	0000 0000	Bits [6:0] of user Y offset
OFF_Z_MSB	R/W	0x0D	0x0E	0000 0000	Bits [14:7] of user Z offset
OFF_Z_LSB	R/W	0x0E	0x0F	0000 0000	Bits [6:0] of user Z offset
DIE_TEMP <sup>(2)</sup>	R	0x0F	0x10	data	Temperature, signed 8 bits in °C
CTRL_REG1 <sup>(3)</sup>	R/W	0x10	0x11	0000 0000	Operation modes
CTRL_REG2 <sup>(3)</sup>	R/W	0x11	0x12	0000 0000	Operation modes

1. Fast Read mode for quickly reading the Most Significant Bytes (MSB) of the sampled data.
2. Register contents are preserved when transitioning from "ACTIVE" to "STANDBY" mode.
3. Modification of this register's contents can only occur when device is "STANDBY" mode, except the TM and AC bit fields in CTRL\_REG1 register.

## 5.1 Sensor Status

### 5.1.1 DR\_STATUS (0x00)

#### Data Ready Status

This read-only status register provides the acquisition status information on a per-sample basis, and reflects real-time updates to the OUT\_X, OUT\_Y, and OUT\_Z registers.

**Table 12. DR\_STATUS Register**

Bit 7	Bit 6	Bit 5	Bit 4	Bit 3	Bit 2	Bit 1	Bit 0
ZYXOW	ZOW	YOW	XOW	ZYXDR	ZDR	YDR	XDR

**Table 13. DR\_STATUS Descriptions**

ZYXOW	X, Y, Z-axis Data Overwrite. Default value: 0. 0: No data overwrite has occurred. 1: Previous X or Y or Z data was overwritten by new X or Y or Z data before it was completely read.
ZOW	Z-axis Data Overwrite. Default value: 0. 0: No data overwrite has occurred. 1: Previous Z-axis data was overwritten by new Z-axis data before it was read.
YOW	Y-axis Data Overwrite. Default value: 0. 0: No data overwrite has occurred. 1: Previous Y-axis data was overwritten by new Y-axis data before it was read.
XOW	X-axis Data Overwrite. Default value: 0. 0: No data overwrite has occurred. 1: Previous X-axis data was overwritten by new X-axis data before it was read.
ZYXDR	X or Y or Z-axis new Data Ready. Default value: 0. 0: No new set of data ready. 1: New set of data is ready.
ZDR	Z-axis new Data Available. Default value: 0. 0: No new Z-axis data is ready. 1: New Z-axis data is ready.
YDR	Z-axis new Data Available. Default value: 0. 0: No new Y-axis data is ready. 1: New Y-axis data is ready.
XDR	Z-axis new Data Available. Default value: 0. 0: No new X-axis data is ready. 1: New X-axis data is ready.

**ZYXOW** is set to 1 whenever new data is acquired before completing the retrieval of the previous set. This event occurs when the content of at least one data register (i.e. OUT\_X, OUT\_Y, OUT\_Z) has been overwritten. ZYXOW is cleared when the high-bytes of the data (OUT\_X\_MSB, OUT\_Y\_MSB, OUT\_Z\_MSB) of all active channels are read.

**ZOW** is set to 1 whenever new Z-axis acquisition is completed before the retrieval of the previous data. When this occurs the previous data is overwritten. ZOW is cleared any time OUT\_Z\_MSB register is read.

**YOW** is set to 1 whenever new Y-axis acquisition is completed before the retrieval of the previous data. When this occurs the previous data is overwritten. YOW is cleared any time OUT\_Y\_MSB register is read.

**XOW** is set to 1 whenever new X-axis acquisition is completed before the retrieval of the previous data. When this occurs the previous data is overwritten. XOW is cleared any time OUT\_X\_MSB register is read.

**ZYXDR** signals that new acquisition for any of the enabled channels is available. ZYXDR is cleared when the high-bytes of the data (OUT\_X\_MSB, OUT\_Y\_MSB, OUT\_Z\_MSB) of all the enabled channels are read.

**ZDR** is set to 1 whenever new Z-axis data acquisition is completed. ZDR is cleared any time OUT\_Z\_MSB register is read.

**YDR** is set to 1 whenever new Y-axis data acquisition is completed. YDR is cleared any time OUT\_Y\_MSB register is read.

**XDR** is set to 1 whenever new X-axis data acquisition is completed. XDR is cleared any time OUT\_X\_MSB register is read.



## 5.1.2 OUT\_X\_MSB (0x01), OUT\_X\_LSB (0x02), OUT\_Y\_MSB (0x03), OUT\_Y\_LSB (0x04), OUT\_Z\_MSB (0x05), OUT\_Z\_LSB (0x06)

X-axis, Y-axis, and Z-axis 16-bit output sample data of the magnetic field strength expressed as signed 2's complement numbers.

When RAW bit is set (CTRL\_REG2[RAW] = 1), the output range is between -20,000 to 20,000 bit counts (the combination of the 1000  $\mu$ T full scale range and the zero-flux offset ranging up to 1000  $\mu$ T).

When RAW bit is clear (CTRL\_REG2[RAW] = 0), the output range is between -30,000 to 30,000 bit counts when the user offset ranging between -10,000 to 10,000 bit counts are included.

The DR\_STATUS register, OUT\_X\_MSB, OUT\_X\_LSB, OUT\_Y\_MSB, OUT\_Y\_LSB, OUT\_Z\_MSB, and OUT\_Z\_LSB are stored in the auto-incrementing address range of 0x00 to 0x06. Data acquisition is a sequential read of 6 bytes.

If the Fast Read (FR) bit is set in CTRL\_REG1 (0x10), auto-increment will skip over LSB of the X, Y, Z sample registers. This will shorten the data acquisition from 6 bytes to 3 bytes. If the LSB registers are directly addressed, the LSB information can still be read regardless of FR bit setting.

The preferred method for reading data registers is the burst-read method where the user application acquires data sequentially starting from register 0x01. If register 0x01 is not read first, the rest of the data registers (0x02 - 0x06) will not be updated with the most recent acquisition. It is still possible to address individual data registers, however register 0x01 must be read prior to ensure that the latest acquisition data is being read.

**Table 14. OUT\_X\_MSB Register**

Bit 7	Bit 6	Bit 5	Bit 4	Bit 3	Bit 2	Bit 1	Bit 0
XD15	XD14	XD13	XD12	XD11	XD10	XD9	XD8

**Table 15. OUT\_X\_LSB Register**

Bit 7	Bit 6	Bit 5	Bit 4	Bit 3	Bit 2	Bit 1	Bit 0
XD7	XD6	XD5	XD4	XD3	XD2	XD1	XD0

**Table 16. OUT\_Y\_MSB Register**

Bit 7	Bit 6	Bit 5	Bit 4	Bit 3	Bit 2	Bit 1	Bit 0
YD15	YD14	YD13	YD12	YD11	YD10	YD9	YD8

**Table 17. OUT\_Y\_LSB Register**

Bit 7	Bit 6	Bit 5	Bit 4	Bit 3	Bit 2	Bit 1	Bit 0
YD7	YD6	YD5	YD4	YD3	YD2	YD1	YD0

**Table 18. OUT\_Z\_MSB Register**

Bit 7	Bit 6	Bit 5	Bit 4	Bit 3	Bit 2	Bit 1	Bit 0
ZD15	ZD14	ZD13	ZD12	ZD11	ZD10	ZD9	ZD8

**Table 19. OUT\_Z\_LSB Register**

Bit 7	Bit 6	Bit 5	Bit 4	Bit 3	Bit 2	Bit 1	Bit 0
ZD6	ZD6	ZD5	ZD4	ZD3	ZD2	ZD1	ZD0

## 5.2 Device ID

### 5.2.1 WHO\_AM\_I (0x07)

Device identification register. This read-only register contains the device identifier which is set to 0xC4. This value is factory programmed.

Table 20. WHO\_AM\_I Register

Bit 7	Bit 6	Bit 5	Bit 4	Bit 3	Bit 2	Bit 1	Bit 0
1	1	0	0	0	1	0	0

### 5.2.2 SYSMOD (0x08)

The read-only system mode register indicates the current device operating mode.

Table 21. SYSMOD Register

Bit 7	Bit 6	Bit 5	Bit 4	Bit 3	Bit 2	Bit 1	Bit 0
0	0	0	0	0	0	SYSMOD1	SYSMOD0

Table 22. SYSMOD Description

SYSMOD	System Mode. Default value: 00. 00: STANDBY mode. 01: ACTIVE mode, RAW data. 10: ACTIVE mode, non-RAW user-corrected data.
--------	---

## 5.3 User Offset Correction

### 5.3.1 OFF\_X\_MSB (0x09), OFF\_X\_LSB (0x0A), OFF\_Y\_MSB (0x0B), OFF\_Y\_LSB (0x0C), OFF\_Z\_MSB (0x0D), OFF\_Z\_LSB (0x0E)

These registers contain the X-axis, Y-axis, and Z-axis user defined offsets in 2's complement format which are used when CTRL\_REG2[RAW] = 0 (see [section 5.5.2](#)) to correct for the MAG3110 zero-flux offset and for hard-iron offsets on the PCB caused by external components. The maximum range for the user offsets is in the range -10,000 to 10,000 bit counts comprising the sum of the correction for the sensor zero-flux offset and the PCB hard-iron offset (range -1000  $\mu$ T to 1000  $\mu$ T or -10,000 to 10,000 bit counts).

The user offsets are automatically subtracted by the MAG3110 logic when CTRL\_REG2[RAW] = 0 before the magnetic field readings are written to the data measurement output registers OUT\_X/Y/Z. The maximum range of the X, Y and Z data measurement registers when CTRL\_REG2[RAW] = 0 is therefore -30,000 to 30,000 bit counts and is computed without clipping. The user offsets are not subtracted when CTRL\_REG2[RAW] = 1. The least significant bit of the user defined X, Y and Z offsets is forced to be zero irrespective of the value written by the user.

If the MAG3110 zero-flux offset and PCB hard-iron offset corrections are performed by an external microprocessor (the most likely scenario) then the user offset registers can be ignored and the CTRL\_REG2[RAW] bit should be set to 1.

The user offset registers should not be confused with the factory calibration corrections which are not user accessible and are always applied to the measured magnetic data irrespective of the setting of CTRL\_REG2[RAW].

Table 23. OFF\_X\_MSB Register

Bit 7	Bit 6	Bit 5	Bit 4	Bit 3	Bit 2	Bit 1	Bit 0
XD14	XD13	XD12	XD11	XD10	XD9	XD8	XD7

Table 24. OFF\_X\_LSB Register

Bit 7	Bit 6	Bit 5	Bit 4	Bit 3	Bit 2	Bit 1	Bit 0
XD6	XD5	XD4	XD3	XD2	XD1	XD0	0

Table 25. OFF\_Y\_MSB Register

Bit 7	Bit 6	Bit 5	Bit 4	Bit 3	Bit 2	Bit 1	Bit 0
YD14	YD13	YD12	YD11	YD10	YD9	YD8	YD7

**Table 26. OFF\_Y\_LSB Register**

Bit 7	Bit 6	Bit 5	Bit 4	Bit 3	Bit 2	Bit 1	Bit 0
YD6	YD5	YD4	YD3	YD2	YD1	YD0	0

**Table 27. OFF\_Z\_MSB Register**

Bit 7	Bit 6	Bit 5	Bit 4	Bit 3	Bit 2	Bit 1	Bit 0
ZD14	ZD13	ZD12	ZD11	ZD10	ZD9	ZD8	ZD7

**Table 28. OFF\_Z\_LSB Register**

Bit 7	Bit 6	Bit 5	Bit 4	Bit 3	Bit 2	Bit 1	Bit 0
ZD6	ZD5	ZD4	ZD3	ZD2	ZD1	ZD0	0

## 5.4 Temperature

### 5.4.1 DIE\_TEMP (0x0F)

The register contains the die temperature in °C expressed as an 8-bit 2's complement number. The sensitivity of the temperature sensor is factory trimmed to 1°C/LSB. The temperature sensor offset is not factory trimmed and must be calibrated by the user software if higher absolute accuracy is required. **Note:** The register allows for temperature measurements from -128°C to 127°C but the output range is limited to -40°C to 125°C. The temperature data is updated on every measurement cycle.

**Table 29. TEMP Register**

Bit 7	Bit 6	Bit 5	Bit 4	Bit 3	Bit 2	Bit 1	Bit 0
T7	T6	T5	T4	T3	T2	T1	T0

## 5.5 Control Registers

### 5.5.1 CTRL\_REG1 (0x10)

**Note:** Except for STANDBY mode selection (Bit 0, AC), the device must be in STANDBY mode to change any of the fields within CTRL\_REG1 (0x10).

**Table 30. CTRL\_REG1 Register**

Bit 7	Bit 6	Bit 5	Bit 4	Bit 3	Bit 2	Bit 1	Bit 0
DR2	DR1	DR0	OS1	OS0	FR	TM	AC

**Table 31. CTRL\_REG1 Description**

DR[2:0]	Output data rate selection. Default value: 000. See <a href="#">Table 32</a> for more information.
OS [1:0]	This register configures the over sampling ratio for the measurement. The selected number of samples is collected and averaged before being placed in the output data registers. The oversampling setting made here applies to both the triggered and active modes of operation. Default value: 00. See <a href="#">Table 32</a> for more information.
FR	Fast Read selection. Default value: 0. 0: The full 16-bit values are read. 1: Fast Read, 8-bit values read from the MSB registers (Auto-increment skips over the LSB register in burst-read mode).
TM	Trigger immediate measurement. Default value: 0 0: Normal operation based on AC condition. 1: Trigger measurement. If part is in ACTIVE mode, any measurement in progress will continue with the highest ODR possible for the selected OSR. In STANDBY mode triggered measurement will occur immediately and part will return to STANDBY mode as soon as the measurement is complete.
AC	Operating mode selection. <b>Note:</b> see <a href="#">section 4.2.6</a> for details. Default value: 0. 0: STANDBY mode. 1: ACTIVE mode. ACTIVE mode will make periodic measurements based on values programmed in the Data Rate (DR) and Over Sampling Ratio bits (OS).

**Table 32. Over-Sampling Ratio and Data Rate Description**

DR2	DR1	DR0	OS1	OS0	Output Rate (Hz)	Over Sample Ratio	ADC Rate (Hz)	Current Typ $\mu$ A	Noise Typ $\mu$ T rms
0	0	0	0	0	80.00	16	1280	900.0	0.4
0	0	0	0	1	40.00	32	1280	900.0	0.35
0	0	0	1	0	20.00	64	1280	900.0	0.3
0	0	0	1	1	10.00	128	1280	900.0	0.25
0	0	1	0	0	40.00	16	640	550.0	0.4
0	0	1	0	1	20.00	32	640	550.0	0.35
0	0	1	1	0	10.00	64	640	550.0	0.3
0	0	1	1	1	5.00	128	640	550.0	0.25
0	1	0	0	0	20.00	16	320	275.0	0.4
0	1	0	0	1	10.00	32	320	275.0	0.35
0	1	0	1	0	5.00	64	320	275.0	0.3
0	1	0	1	1	2.50	128	320	275.0	0.25
0	1	1	0	0	10.00	16	160	137.5	0.4
0	1	1	0	1	5.00	32	160	137.5	0.35
0	1	1	1	0	2.50	64	160	137.5	0.3
0	1	1	1	1	1.25	128	160	137.5	0.25
1	0	0	0	0	5.00	16	80	68.8	0.4
1	0	0	0	1	2.50	32	80	68.8	0.35
1	0	0	1	0	1.25	64	80	68.8	0.3
1	0	0	1	1	0.63	128	80	68.8	0.25
1	0	1	0	0	2.50	16	80	34.4	0.4
1	0	1	0	1	1.25	32	80	34.4	0.35
1	0	1	1	0	0.63	64	80	34.4	0.3
1	0	1	1	1	0.31	128	80	34.4	0.25
1	1	0	0	0	1.25	16	80	17.2	0.4
1	1	0	0	1	0.63	32	80	17.2	0.35
1	1	0	1	0	0.31	64	80	17.2	0.3
1	1	0	1	1	0.16	128	80	17.2	0.25
1	1	1	0	0	0.63	16	80	8.6	0.4
1	1	1	0	1	0.31	32	80	8.6	0.35
1	1	1	1	0	0.16	64	80	8.6	0.3
1	1	1	1	1	0.08	128	80	8.6	0.25

## 5.5.2 CTRL\_REG2 (0x11)

**Table 33. CTRL\_REG2 Register**

Bit 7	Bit 6	Bit 5	Bit 4	Bit 3	Bit 2	Bit 1	Bit 0
AUTO_MRST_EN	—	RAW	Mag_RST	—	—	—	—

**Table 34. CTRL\_REG2 Description**

AUTO_MRST_EN	<p>Automatic Magnetic Sensor Reset. Default value: 0.</p> <p>0: Automatic magnetic sensor resets disabled.</p> <p>1: Automatic magnetic sensor resets enabled.</p> <p>Similar to Mag_RST, however, the resets occur automatically before each data acquisition.</p> <p>This bit is recommended to be always explicitly enabled by the host application. This a WRITE ONLY bit and always reads back as 0.</p>
RAW	<p>Data output correction. Default value: 0.</p> <p>0: Normal mode: data values are corrected by the user offset register values.</p> <p>1: Raw mode: data values are not corrected by the user offset register values.</p> <p><b>Note:</b> The factory calibration is always applied to the measured data stored in registers 0x01 to 0x06 irrespective of the setting of the RAW bit.</p>
Mag_RST	<p>Magnetic Sensor Reset (One-Shot). Default value: 0.</p> <p>0: Reset cycle not active.</p> <p>1: Reset cycle initiate or Reset cycle busy/active.</p> <p>When asserted, initiates a magnetic sensor reset cycle that will restore correct operation after exposure to an excessive magnetic field which exceeds the Full Scale Range (see <a href="#">Table 3</a>) but is less than the Maximum Applied Magnetic Field (see <a href="#">Table 4</a>).</p> <p>When the cycle is finished, value returns to 0.</p>

## 6 Geomagnetic Field Maps

The magnitude of the geomagnetic field varies from 25  $\mu\text{T}$  in South America to about 60  $\mu\text{T}$  over Northern China. The horizontal component of the field varies from zero at the magnetic poles to 40  $\mu\text{T}$ .

These web sites have further information:

<http://wdc.kugi.kyoto-u.ac.jp/igrf/>

<http://geomag.usgs.gov/>

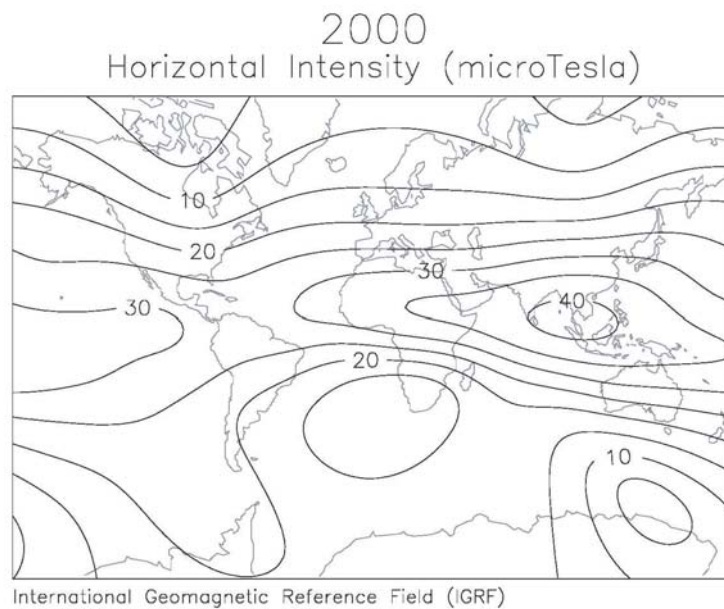
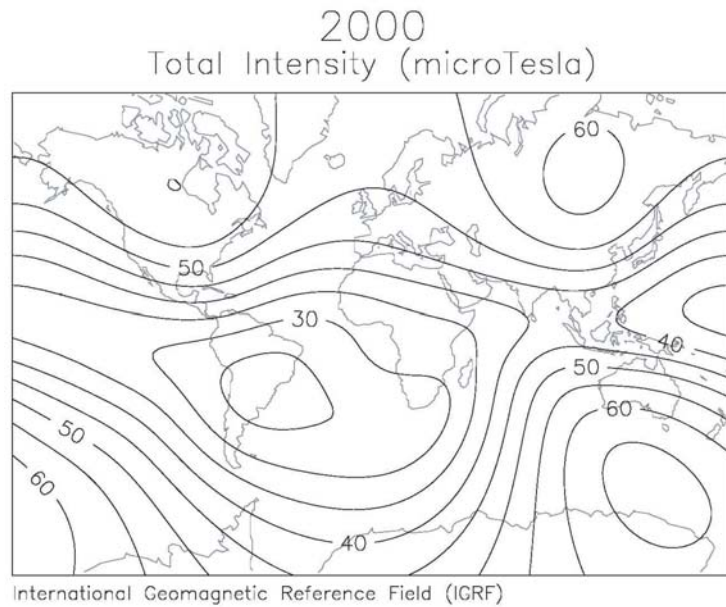

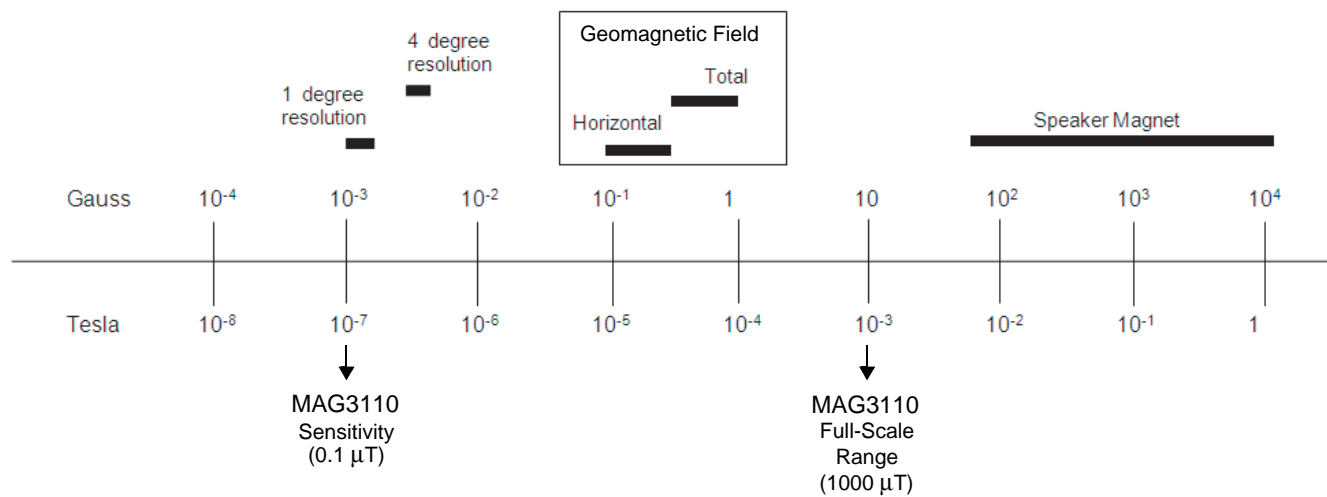

## 7 PCB Guidelines

Surface mount Printed Circuit Board (PCB) layout is a critical portion of the total design. The footprint for the surface mount packages must be the correct size to ensure proper solder connection interface between the PCB and the package. With the correct footprint, the packages will self-align when subjected to a solder reflow process. These guidelines are for soldering and mounting the Dual Flat No-Lead (DFN) package inertial sensors to PCBs. The purpose is to minimize the stress on the package after board mounting. The MAG3110 digital output magnetometers use the DFN package platform. This section describes suggested methods of soldering these devices to the PCB for consumer applications.

Please see Freescale application note AN4247, "Layout Recommendation for PCBs Using a magnetometer Sensor" for a technical discussion on hard and soft-iron magnetic interference and general guidelines on layout and component selection applicable to any PCB using a magnetometer sensor.

Freescale application note AN1902, "Quad Flat Pack No-Lead (QFN) Micro Dual Flat Pack No-Lead ( $\mu$ DFN)" discusses the DFN package used by the MAG3110, PCB design guidelines for using DFN packages and temperature profiles for reflow soldering.

### 7.1 Overview of Soldering Considerations

Information provided here is based on experiments executed on DFN devices. They do not represent exact conditions present at a customer site. Hence, information herein should be used as guidance only and process and design optimizations are recommended to develop an application specific solution. It should be noted that with the proper PCB footprint and solder stencil designs, the package will self-align during the solder reflow process.

### 7.2 Halogen Content

This package is designed to be Halogen Free, exceeding most industry and customer standards. Halogen Free means that no homogeneous material within the assembly package shall contain chlorine (Cl) in excess of 700 ppm or 0.07% weight/weight or bromine (Br) in excess of 900 ppm or 0.09% weight/weight.

### 7.3 PCB Mounting Recommendations

1. The PCB land should be designed as Non Solder Mask Defined (NSMD) as shown in [Figure 7](#).
2. No additional via pattern underneath package.
3. PCB land pad is 0.6 mm x 0.225 mm as shown in [Figure 7](#).
4. Solder mask opening = PCB land pad edge + 0.125 mm larger all around = 0.725 mm x 1.950 mm
5. Stencil opening = PCB land pad -0.05 mm smaller all around = 0.55 mm x 0.175 mm.
6. Stencil thickness is 100 or 125  $\mu$ m.
7. Do not place any components or vias at a distance less than 2 mm from the package land area. This may cause additional package stress if it is too close to the package land area.
8. Signal traces connected to pads are as symmetric as possible. Put dummy traces on NC pads in order to have same length of exposed trace for all pads.
9. Use a standard pick and place process and equipment. Do not use a hand soldering process.
10. Assemble PCB when in an enclosure. Using caution, determine the position of screw down holes and any press fit. It is important that the assembled PCB remain flat after assembly to keep electronic operation of the device optimal.
11. The PCB should be rated for the multiple lead-free reflow condition with max 260°C temperature.
12. No copper traces on top layer of PCB under the package. This will cause planarity issues with board mount. Freescale DFN sensors are compliant with Restrictions on Hazardous Substances (RoHS), having halide free molding compound (green) and lead-free terminations. These terminations are compatible with tin-lead (Sn-Pb) as well as tin-silver-copper (Sn-Ag-Cu) solder paste soldering processes. Reflow profiles applicable to those processes can be used successfully for soldering the devices.



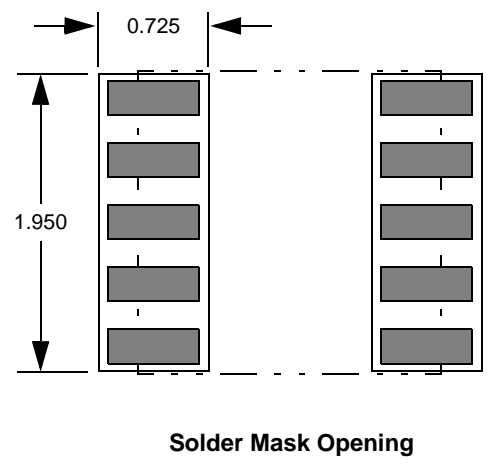
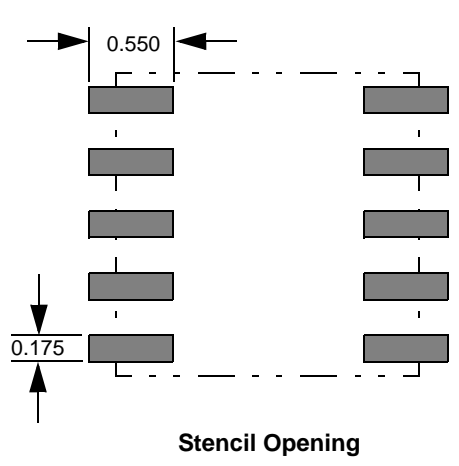
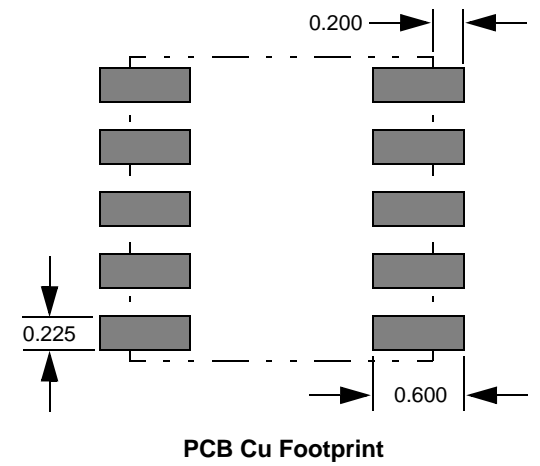
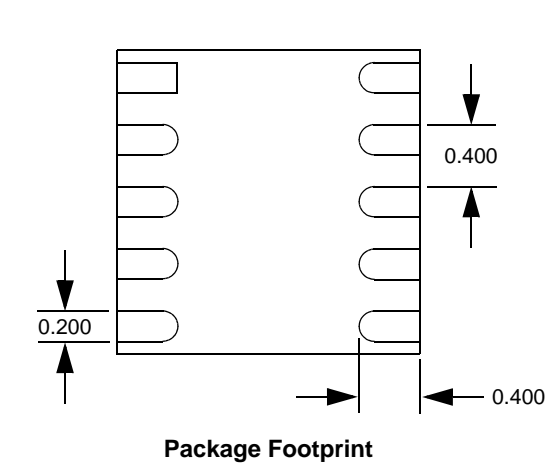

**Figure 7. Footprints and Soldering Masks (dimensions in mm)**

### PACKAGE DIMENSIONS

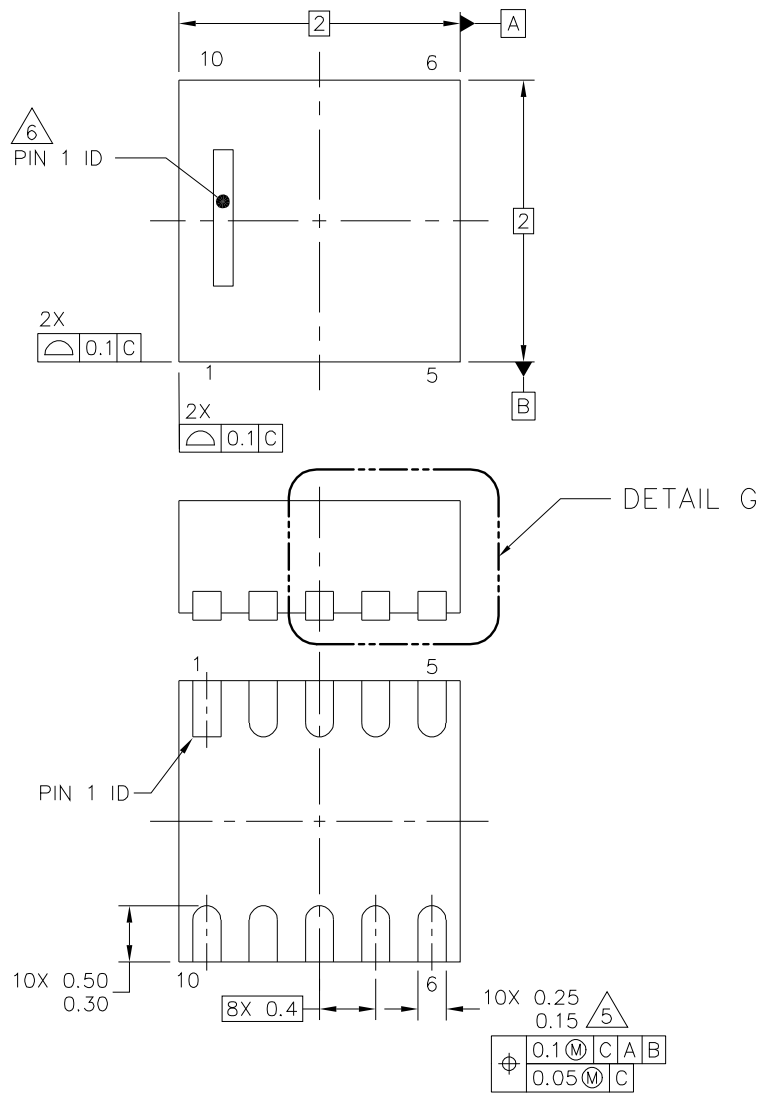

© FREESCALE SEMICONDUCTOR, INC. ALL RIGHTS RESERVED.	<b>MECHANICAL OUTLINE</b>	PRINT VERSION NOT TO SCALE	
TITLE: DFN-COL, 2 X 2 X 0.85, 0.4 PITCH, 10 TERMINAL		DOCUMENT NO: 98ASA00264D	REV: A
		CASE NUMBER: 2154-02	30 MAY 2012
STANDARD: NON-JEDEC			

### CASE 2154-02 ISSUE A 10-PIN DFN

# PACKAGE DIMENSIONS

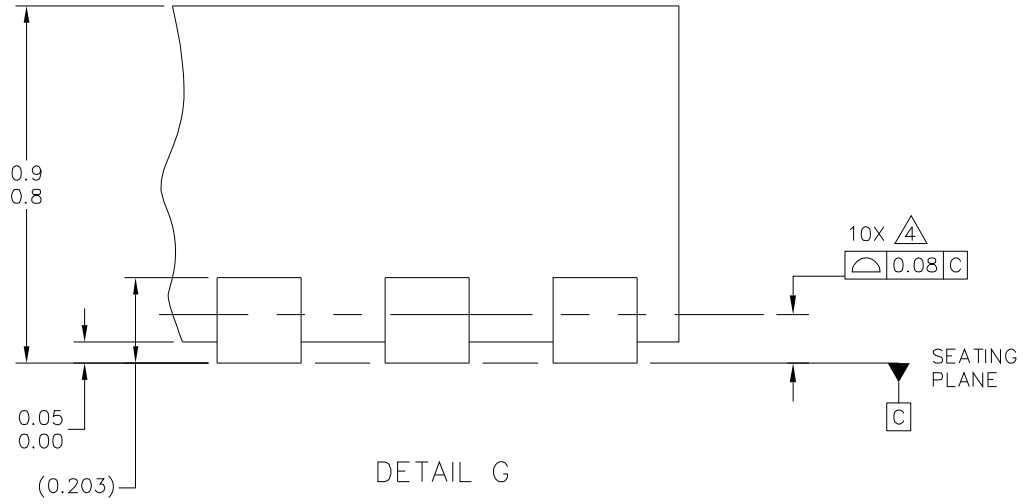



© FREESCALE SEMICONDUCTOR, INC. ALL RIGHTS RESERVED.	<b>MECHANICAL OUTLINE</b>	PRINT VERSION NOT TO SCALE	
TITLE: DFN-COL, 2 X 2 X 0.85, 0.4 PITCH, 10 TERMINAL		DOCUMENT NO: 98ASA00264D	REV: A
		CASE NUMBER: 2154-02	30 MAY 2012
STANDARD: NON-JEDEC			

**CASE 2154-02  
ISSUE A  
10-PIN DFN**

**MAG3110**

## PACKAGE DIMENSIONS

NOTES:

1. ALL DIMENSIONS ARE IN MILLIMETERS.
2. DIMENSIONING AND TOLERANCING PER ASME Y14.5M-1994.
3. THIS IS NON JEDEC REGISTERED PACKAGE.
4.  COPLANARITY APPLIES TO ALL TERMINALS.
5.  THIS DIMENSION APPLIES TO METALLIZED TERMINAL AND IS MEASURE BETWEEN 0.15 AND 0.25 FROM THE TERMINAL TIP. IF THE TERMINAL HAS THE OPTIONAL RADIUS ON THE OTHER END OF THE TERMINAL, THIS DIMENSION SHALL NOT BE MEASURED IN THE RADIUS AREA.
6.  PIN 1 ID ON TOP WILL BE LASER MARKED.

© FREESCALE SEMICONDUCTOR, INC. ALL RIGHTS RESERVED.	<b>MECHANICAL OUTLINE</b>	PRINT VERSION NOT TO SCALE	
TITLE: <div style="text-align: center; margin-left: 100px;">DFN-COL,</div> 2 X 2 X 0.85, 0.4 PITCH, 10 TERMINAL		DOCUMENT NO: 98ASA00264D	REV: A
		CASE NUMBER: 2154-02	30 MAY 2012
		STANDARD: NON-JEDEC	

**CASE 2154-02**  
**ISSUE A**  
**10-PIN DFN**

**Table 35. Revision history**

Revision number	Revision date	Description of changes
8	05/2012	<ul style="list-style-type: none"><li>• Updated content on page 1.</li><li>• Updated pin descriptions in Table 1.</li><li>• Updated pin connection drawing and Figure 2 to reflect horizontal bar for pin 1.</li><li>• Added Figure 3, Device Marking Diagram</li><li>• Updated Output Data Range row in Table 2.</li><li>• Updated Figure 4 to include pin names.</li><li>• Updated Bit 7 in Table 31 and 32 for emphasis. Changed description as highlighted in Red and bold text.</li></ul>
9	09/2012	<ul style="list-style-type: none"><li>• Added FXMS3110CDR1, Windows 8 option to ordering information.</li><li>• Table 1: Updated Pin 6, SDA, description.</li><li>• Table 2: added Sensor die-to-package row.</li><li>• Updated Table 5, Boot time from power row Max value from deleted, Typ value added, 1.7.</li><li>• Deleted section 4.1. Updated I<sup>2</sup>C sections 4.3.1 and 4.3.2 (replaced Pullup section).</li></ul>
9.1	10/2012	<ul style="list-style-type: none"><li>• Table 2: added Sensor die-to-package row.</li></ul>
9.2	02/2013	<ul style="list-style-type: none"><li>• Updated ordering table, deleted MAG3110FCR2 option.</li><li>• Table title for Table 2 and Table 5: Updated VDD = 1.8 V to VDD = 2.4 V and added VDDIO = 1.8 V.</li><li>• Updated second paragraph in Section 5.3.1 “The user offsets are automatically added by the MAG3110... “ to “The user offsets are automatically subtracted by the MAG3110... “</li></ul>

---

**How to Reach Us:**

**Home Page:**

[freescale.com](http://freescale.com)

**Web Support:**

[freescale.com/support](http://freescale.com/support)

Information in this document is provided solely to enable system and software implementers to use Freescale products. There are no express or implied copyright licenses granted hereunder to design or fabricate any integrated circuits based on the information in this document.

Freescale reserves the right to make changes without further notice to any products herein. Freescale makes no warranty, representation, or guarantee regarding the suitability of its products for any particular purpose, nor does Freescale assume any liability arising out of the application or use of any product or circuit, and specifically disclaims any and all liability, including without limitation consequential or incidental damages. "Typical" parameters that may be provided in Freescale data sheets and/or specifications can and do vary in different applications, and actual performance may vary over time. All operating parameters, including "typicals," must be validated for each customer application by customer's technical experts. Freescale does not convey any license under its patent rights nor the rights of others. Freescale sells products pursuant to standard terms and conditions of sale, which can be found at the following address: [freescale.com/SalesTermsandConditions](http://freescale.com/SalesTermsandConditions).

Freescale, the Freescale logo, AltiVec, C-5, CodeTest, CodeWarrior, ColdFire, C-Ware, Energy Efficient Solutions logo, Kinetis, mobileGT, PowerQUICC, Processor Expert, QorIQ, Qorivva, StarCore, Symphony, and VortiQa are trademarks of Freescale Semiconductor, Inc., Reg. U.S. Pat. & Tm. Off. Airfast, BeeKit, BeeStack, ColdFire+, CoreNet, Flexis, MagniV, MXC, Platform in a Package, QorIQ Qonverge, QUICC Engine, Ready Play, SafeAssure, SMARTMOS, TurboLink, Vybrid, and Xtrinsic are trademarks of Freescale Semiconductor, Inc. All other product or service names are the property of their respective owners.

© 2013 Freescale Semiconductor, Inc.

Document Number: MAG3110

Rev. 9.2

02/2013

