

## Dual and Quad 250 $\mu$ A, 3MHz, 200V/ $\mu$ s Operational Amplifiers

### FEATURES

- 3MHz Gain Bandwidth
- 200V/ $\mu$ s Slew Rate
- 250 $\mu$ A Supply Current per Amplifier
- C-Load™ Op Amp Drives All Capacitive Loads
- Unity-Gain Stable
- Maximum Input Offset Voltage: 600 $\mu$ V
- Maximum Input Bias Current: 50nA
- Maximum Input Offset Current: 15nA
- Minimum DC Gain,  $R_L = 2k$ : 30V/mV
- Input Noise Voltage: 14nV/ $\sqrt{Hz}$
- Settling Time to 0.1%, 10V Step: 700ns
- Settling Time to 0.01%, 10V Step: 1.25 $\mu$ s
- Minimum Output Swing into 1k:  $\pm 13V$
- Minimum Output Swing into 500 $\Omega$ :  $\pm 3.4V$
- Specified at  $\pm 2.5V$ ,  $\pm 5V$  and  $\pm 15V$
- Available in SO-8 Package
- LT1353 in Narrow Surface Mount Package

### APPLICATIONS

- Battery-Powered Systems
- Wideband Amplifiers
- Buffers
- Active Filters
- Data Acquisition Systems
- Photodiode Amplifiers

### DESCRIPTION

The LT<sup>®</sup>1352/LT1353 are dual and quad, very low power, high speed operational amplifiers with outstanding AC and DC performance. The amplifiers feature much lower supply current and higher slew rate than devices with comparable bandwidth. The circuit combines the slewing performance of a current feedback amplifier in a true operational amplifier with matched high impedance inputs. The high slew rate ensures that the large-signal bandwidth is not degraded. Each output is capable of driving a 1k $\Omega$  load to  $\pm 13V$  with  $\pm 15V$  supplies and a 500 $\Omega$  load to  $\pm 3.4V$  on  $\pm 5V$  supplies.

The LT1352/LT1353 are members of a family of fast, high performance amplifiers using this unique topology and employing Linear Technology Corporation's advanced complementary bipolar processing. For higher bandwidth devices with higher supply current see the LT1354 through LT1365 data sheets. Bandwidths of 12MHz, 25MHz, 50MHz and 70MHz are available with 1mA, 2mA, 4mA and 6mA of supply current per amplifier. Singles, duals and quads of each amplifier are available. The LT1352 is available in an 8-lead SO package. The LT1353 is offered in a 14-lead narrow surface mount package.

LT, LTC and LT are registered trademarks of Linear Technology Corporation.  
C-Load is a trademark of Linear Technology Corporation.

### TYPICAL APPLICATION

Instrumentation Amplifier

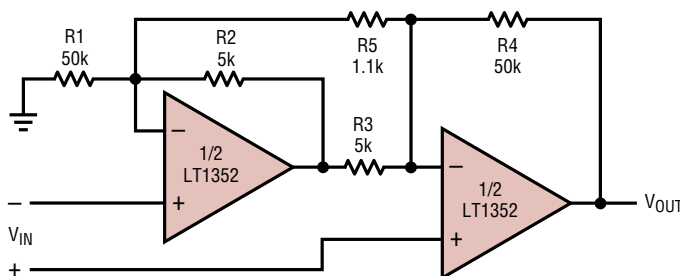

GAIN =  $[R4/R3][1 + (1/2)(R2/R1 + R3/R4) + (R2 + R3)/R5] = 102$   
 TRIM R5 FOR GAIN  
 TRIM R1 FOR COMMON MODE REJECTION  
 BW = 30kHz

1352/53 TA01

Large-Signal Response

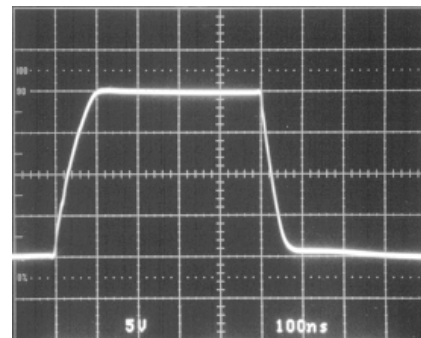

$A_V = -1$

1352/53 TA02

13523fa

# LT1352/LT1353

## ABSOLUTE MAXIMUM RATINGS

(Note 1)

Total Supply Voltage ( $V^+$  to  $V^-$ ) ..... 36V  
 Differential Input Voltage (Transient Only, Note 2)  $\pm 10V$   
 Input Voltage .....  $\pm V_S$   
 Output Short-Circuit Duration (Note 3) ..... Indefinite  
 Operating Temperature Range .....  $-40^\circ\text{C}$  to  $85^\circ\text{C}$

Specified Temperature Range (Note 7) ..  $-40^\circ\text{C}$  to  $85^\circ\text{C}$   
 Maximum Junction Temperature (See Below)  
 Plastic Package .....  $150^\circ\text{C}$   
 Storage Temperature Range .....  $-65^\circ\text{C}$  to  $150^\circ\text{C}$   
 Lead Temperature (Soldering, 10 sec) .....  $300^\circ\text{C}$

## PACKAGE/ORDER INFORMATION

<p>N8 PACKAGE 8-LEAD PDIP</p> <p>S8 PACKAGE 8-LEAD PLASTIC SO</p> <p><math>T_{JMAX} = 150^\circ\text{C}</math>, <math>\theta_{JA} = 130^\circ\text{C/W}</math> (N8)  <math>T_{JMAX} = 150^\circ\text{C}</math>, <math>\theta_{JA} = 190^\circ\text{C/W}</math> (S8)</p>	ORDER PART NUMBER	<p>S PACKAGE 14-LEAD PLASTIC SO</p> <p><math>T_{JMAX} = 150^\circ\text{C}</math>, <math>\theta_{JA} = 150^\circ\text{C/W}</math></p>	ORDER PART NUMBER
	LT1352CN8 LT1352CS8 LT1352IN8 LT1352IS8		LT1353CS
	S8 PART MARKING		
	1352 1352I		

Consult LTC Marketing for parts specified with wider operating temperature ranges.

## ELECTRICAL CHARACTERISTICS $T_A = 25^\circ\text{C}$ , $V_{CM} = 0V$ unless otherwise noted

SYMBOL	PARAMETER	CONDITIONS	$V_{SUPPLY}$	MIN	TYP	MAX	UNITS	
$V_{OS}$	Input Offset Voltage		$\pm 15V$	0.2	0.6		mV	
			$\pm 5V$	0.2	0.6		mV	
			$\pm 2.5V$	0.3	0.8		mV	
$I_{OS}$	Input Offset Current		$\pm 2.5V$ to $\pm 15V$	5	15		nA	
$I_B$	Input Bias Current		$\pm 2.5V$ to $\pm 15V$	20	50		nA	
$e_n$	Input Noise Voltage	$f = 10\text{kHz}$	$\pm 2.5V$ to $\pm 15V$	14			$\text{nV}/\sqrt{\text{Hz}}$	
$i_n$	Input Noise Current	$f = 10\text{kHz}$	$\pm 2.5V$ to $\pm 15V$	0.5			$\text{pA}/\sqrt{\text{Hz}}$	
$R_{IN}$	Input Resistance	$V_{CM} = \pm 12V$ Differential	$\pm 15V$	300	600		$\text{M}\Omega$	
			$\pm 15V$		20		$\text{M}\Omega$	
$C_{IN}$	Input Capacitance		$\pm 15V$	3			pF	
			Positive Input Voltage Range	$\pm 15V$	12.0	13.5		V
				$\pm 5V$	2.5	3.5		V
Negative Input Voltage Range	$\pm 2.5V$	0.5	1.0		V			
	$\pm 15V$		-13.5	-12.0		V		
	$\pm 5V$		-3.5	-2.5		V		
CMRR	Common Mode Rejection Ratio	$V_{CM} = \pm 12V$ $V_{CM} = \pm 2.5V$ $V_{CM} = \pm 0.5V$	$\pm 15V$	80	94		dB	
			$\pm 5V$	78	86		dB	
			$\pm 2.5V$	68	77		dB	
PSRR	Power Supply Rejection Ratio	$V_S = \pm 2.5V$ to $\pm 15V$		90	106		dB	

13523fa

**ELECTRICAL CHARACTERISTICS**  $T_A = 25^\circ\text{C}$ ,  $V_{CM} = 0\text{V}$  unless otherwise noted

SYMBOL	PARAMETER	CONDITIONS	$V_{SUPPLY}$	MIN	TYP	MAX	UNITS
$A_{VOL}$	Large-Signal Voltage Gain	$V_{OUT} = \pm 12\text{V}$ , $R_L = 5\text{k}$	$\pm 15\text{V}$	40	80		V/mV
		$V_{OUT} = \pm 10\text{V}$ , $R_L = 2\text{k}$	$\pm 15\text{V}$	30	60		V/mV
		$V_{OUT} = \pm 10\text{V}$ , $R_L = 1\text{k}$	$\pm 15\text{V}$	20	40		V/mV
		$V_{OUT} = \pm 2.5\text{V}$ , $R_L = 5\text{k}$	$\pm 5\text{V}$	30	60		V/mV
		$V_{OUT} = \pm 2.5\text{V}$ , $R_L = 2\text{k}$	$\pm 5\text{V}$	25	50		V/mV
		$V_{OUT} = \pm 2.5\text{V}$ , $R_L = 1\text{k}$	$\pm 5\text{V}$	15	30		V/mV
		$V_{OUT} = \pm 1\text{V}$ , $R_L = 5\text{k}$	$\pm 2.5\text{V}$	20	40		V/mV
$V_{OUT}$	Output Swing	$R_L = 5\text{k}$ , $V_{IN} = \pm 10\text{mV}$	$\pm 15\text{V}$	13.5	14.0		$\pm\text{V}$
		$R_L = 2\text{k}$ , $V_{IN} = \pm 10\text{mV}$	$\pm 15\text{V}$	13.4	13.8		$\pm\text{V}$
		$R_L = 1\text{k}$ , $V_{IN} = \pm 10\text{mV}$	$\pm 15\text{V}$	13.0	13.4		$\pm\text{V}$
		$R_L = 1\text{k}$ , $V_{IN} = \pm 10\text{mV}$	$\pm 5\text{V}$	3.5	4.0		$\pm\text{V}$
		$R_L = 500\Omega$ , $V_{IN} = \pm 10\text{mV}$	$\pm 5\text{V}$	3.4	3.8		$\pm\text{V}$
		$R_L = 5\text{k}$ , $V_{IN} = \pm 10\text{mV}$	$\pm 2.5\text{V}$	1.3	1.7		$\pm\text{V}$
$I_{OUT}$	Output Current	$V_{OUT} = \pm 13\text{V}$	$\pm 15\text{V}$	13.0	13.4		mA
		$V_{OUT} = \pm 3.4\text{V}$	$\pm 5\text{V}$	6.8	7.6		mA
$I_{SC}$	Short-Circuit Current	$V_{OUT} = 0\text{V}$ , $V_{IN} = \pm 3\text{V}$	$\pm 15\text{V}$	30	45		mA
SR	Slew Rate	$A_V = -1$ , $R_L = 5\text{k}$ (Note 4)	$\pm 15\text{V}$	120	200		V/ $\mu\text{s}$
			$\pm 5\text{V}$	30	50		V/ $\mu\text{s}$
GBW	Gain Bandwidth	10V Peak (Note 5) 3V Peak (Note 5)	$\pm 15\text{V}$		3.2		MHz
			$\pm 5\text{V}$		2.6		MHz
GBW	Gain Bandwidth	$f = 200\text{kHz}$ , $R_L = 10\text{k}$	$\pm 15\text{V}$	2.0	3.0		MHz
			$\pm 5\text{V}$	1.8	2.7		MHz
			$\pm 2.5\text{V}$		2.5		MHz
$t_r$ , $t_f$	Rise Time, Fall Time	$A_V = 1$ , 10% to 90%, 0.1V	$\pm 15\text{V}$		46		ns
			$\pm 5\text{V}$		53		ns
	Overshoot	$A_V = 1$ , 0.1V	$\pm 15\text{V}$		13		%
			$\pm 5\text{V}$		16		%
	Propagation Delay	50% $V_{IN}$ to 50% $V_{OUT}$ , 0.1V	$\pm 15\text{V}$		41		ns
			$\pm 5\text{V}$		52		ns
$t_s$	Settling Time	10V Step, 0.1%, $A_V = -1$ 10V Step, 0.01%, $A_V = -1$ 5V Step, 0.1%, $A_V = -1$ 5V Step, 0.01%, $A_V = -1$	$\pm 15\text{V}$		700		ns
			$\pm 15\text{V}$		1250		ns
			$\pm 5\text{V}$		950		ns
			$\pm 5\text{V}$		1400		ns
$R_O$	Output Resistance	$A_V = 1$ , $f = 20\text{kHz}$	$\pm 15\text{V}$		1.5		$\Omega$
	Channel Separation	$V_{OUT} = \pm 10\text{V}$ , $R_L = 2\text{k}$	$\pm 15\text{V}$	101	120		dB
$I_S$	Supply Current	Each Amplifier Each Amplifier	$\pm 15\text{V}$		250	320	$\mu\text{A}$
			$\pm 5\text{V}$		230	300	$\mu\text{A}$

$0^\circ\text{C} \leq T_A \leq 70^\circ\text{C}$ ,  $V_{CM} = 0\text{V}$  unless otherwise noted

SYMBOL	PARAMETER	CONDITIONS	$V_{SUPPLY}$	MIN	TYP	MAX	UNITS
$V_{OS}$	Input Offset Voltage		$\pm 15\text{V}$			0.8	mV
			$\pm 5\text{V}$			0.8	mV
			$\pm 2.5\text{V}$			1.0	mV
	Input $V_{OS}$ Drift	(Note 6)	$\pm 2.5\text{V}$ to $\pm 15\text{V}$		3	8	$\mu\text{V}/^\circ\text{C}$
$I_{OS}$	Input Offset Current		$\pm 2.5\text{V}$ to $\pm 15\text{V}$			20	nA
$I_B$	Input Bias Current		$\pm 2.5\text{V}$ to $\pm 15\text{V}$			75	nA

**ELECTRICAL CHARACTERISTICS**  $0^{\circ}\text{C} \leq T_A \leq 70^{\circ}\text{C}$ ,  $V_{\text{CM}} = 0\text{V}$  unless otherwise noted

SYMBOL	PARAMETER	CONDITIONS	V <sub>SUPPLY</sub>	MIN	TYP	MAX	UNITS
CMRR	Common Mode Rejection Ratio	$V_{\text{CM}} = \pm 12\text{V}$	$\pm 15\text{V}$	78			dB
		$V_{\text{CM}} = \pm 2.5\text{V}$	$\pm 5\text{V}$	77			dB
		$V_{\text{CM}} = \pm 0.5\text{V}$	$\pm 2.5\text{V}$	67			dB
PSRR	Power Supply Rejection Ratio	$V_S = \pm 2.5\text{V}$ to $\pm 15\text{V}$		89			dB
A <sub>VOL</sub>	Large-Signal Voltage Gain	$V_{\text{OUT}} = \pm 12\text{V}$ , $R_L = 5\text{k}$	$\pm 15\text{V}$	25			V/mV
		$V_{\text{OUT}} = \pm 10\text{V}$ , $R_L = 2\text{k}$	$\pm 15\text{V}$	20			V/mV
		$V_{\text{OUT}} = \pm 2.5\text{V}$ , $R_L = 5\text{k}$	$\pm 5\text{V}$	20			V/mV
		$V_{\text{OUT}} = \pm 2.5\text{V}$ , $R_L = 2\text{k}$	$\pm 5\text{V}$	15			V/mV
		$V_{\text{OUT}} = \pm 2.5\text{V}$ , $R_L = 1\text{k}$	$\pm 5\text{V}$	10			V/mV
		$V_{\text{OUT}} = \pm 1\text{V}$ , $R_L = 5\text{k}$	$\pm 2.5\text{V}$	15			V/mV
V <sub>OUT</sub>	Output Swing	$R_L = 5\text{k}$ , $V_{\text{IN}} = \pm 10\text{mV}$	$\pm 15\text{V}$	13.4			$\pm\text{V}$
		$R_L = 2\text{k}$ , $V_{\text{IN}} = \pm 10\text{mV}$	$\pm 15\text{V}$	13.3			$\pm\text{V}$
		$R_L = 1\text{k}$ , $V_{\text{IN}} = \pm 10\text{mV}$	$\pm 15\text{V}$	12.0			$\pm\text{V}$
		$R_L = 1\text{k}$ , $V_{\text{IN}} = \pm 10\text{mV}$	$\pm 5\text{V}$	3.4			$\pm\text{V}$
		$R_L = 500\Omega$ , $V_{\text{IN}} = \pm 10\text{mV}$	$\pm 5\text{V}$	3.3			$\pm\text{V}$
		$R_L = 5\text{k}$ , $V_{\text{IN}} = \pm 10\text{mV}$	$\pm 2.5\text{V}$	1.2			$\pm\text{V}$
I <sub>OUT</sub>	Output Current	$V_{\text{OUT}} = \pm 12\text{V}$	$\pm 15\text{V}$	12.0			mA
		$V_{\text{OUT}} = \pm 3.3\text{V}$	$\pm 5\text{V}$	6.6			mA
I <sub>SC</sub>	Short-Circuit Current	$V_{\text{OUT}} = 0\text{V}$ , $V_{\text{IN}} = \pm 3\text{V}$	$\pm 15\text{V}$	24			mA
SR	Slew Rate	$A_V = -1$ , $R_L = 5\text{k}$ (Note 4)	$\pm 15\text{V}$	100			V/ $\mu\text{s}$
			$\pm 5\text{V}$	21			V/ $\mu\text{s}$
GBW	Gain Bandwidth	$f = 200\text{kHz}$ , $R_L = 10\text{k}$	$\pm 15\text{V}$	1.8			MHz
			$\pm 5\text{V}$	1.6			MHz
	Channel Separation	$V_{\text{OUT}} = \pm 10\text{V}$ , $R_L = 2\text{k}$	$\pm 15\text{V}$	100			dB
I <sub>S</sub>	Supply Current	Each Amplifier	$\pm 15\text{V}$			350	$\mu\text{A}$
			$\pm 5\text{V}$			330	$\mu\text{A}$

$-40^{\circ}\text{C} \leq T_A \leq 85^{\circ}\text{C}$ ,  $V_{\text{CM}} = 0\text{V}$  unless otherwise noted (Note 7)

SYMBOL	PARAMETER	CONDITIONS	V <sub>SUPPLY</sub>	MIN	TYP	MAX	UNITS
V <sub>OS</sub>	Input Offset Voltage		$\pm 15\text{V}$			1.0	mV
			$\pm 5\text{V}$			1.0	mV
			$\pm 2.5\text{V}$			1.2	mV
	Input V <sub>OS</sub> Drift	(Note 6)	$\pm 2.5\text{V}$ to $\pm 15\text{V}$		3	8	$\mu\text{V}/^{\circ}\text{C}$
I <sub>OS</sub>	Input Offset Current		$\pm 2.5\text{V}$ to $\pm 15\text{V}$			50	nA
I <sub>B</sub>	Input Bias Current		$\pm 2.5\text{V}$ to $\pm 15\text{V}$			100	nA
CMRR	Common Mode Rejection Ratio	$V_{\text{CM}} = \pm 12\text{V}$	$\pm 15\text{V}$	76			dB
		$V_{\text{CM}} = \pm 2.5\text{V}$	$\pm 5\text{V}$	76			dB
		$V_{\text{CM}} = \pm 0.5\text{V}$	$\pm 2.5\text{V}$	66			dB
PSRR	Power Supply Rejection Ratio	$V_S = \pm 2.5\text{V}$ to $\pm 15\text{V}$		87			dB
A <sub>VOL</sub>	Large-Signal Voltage Gain	$V_{\text{OUT}} = \pm 12\text{V}$ , $R_L = 5\text{k}$	$\pm 15\text{V}$	20			V/mV
		$V_{\text{OUT}} = \pm 10\text{V}$ , $R_L = 2\text{k}$	$\pm 15\text{V}$	15			V/mV
		$V_{\text{OUT}} = \pm 2.5\text{V}$ , $R_L = 5\text{k}$	$\pm 5\text{V}$	15			V/mV
		$V_{\text{OUT}} = \pm 2.5\text{V}$ , $R_L = 2\text{k}$	$\pm 5\text{V}$	10			V/mV
		$V_{\text{OUT}} = \pm 2.5\text{V}$ , $R_L = 1\text{k}$	$\pm 5\text{V}$	8			V/mV
		$V_{\text{OUT}} = \pm 1\text{V}$ , $R_L = 5\text{k}$	$\pm 2.5\text{V}$	10			V/mV

**ELECTRICAL CHARACTERISTICS**  $-40^{\circ}\text{C} \leq T_A \leq 85^{\circ}\text{C}$ ,  $V_{\text{CM}} = 0\text{V}$  unless otherwise noted (Note 7)

SYMBOL	PARAMETER	CONDITIONS	V <sub>SUPPLY</sub>	MIN	TYP	MAX	UNITS
V <sub>OUT</sub>	Output Swing	R <sub>L</sub> = 5k, V <sub>IN</sub> = ±10mV	±15V	13.3			±V
		R <sub>L</sub> = 2k, V <sub>IN</sub> = ±10mV	±15V	13.2			±V
		R <sub>L</sub> = 1k, V <sub>IN</sub> = ±10mV	±15V	10.0			±V
		R <sub>L</sub> = 1k, V <sub>IN</sub> = ±10mV	±5V	3.3			±V
		R <sub>L</sub> = 500Ω, V <sub>IN</sub> = ±10mV	±5V	3.2			±V
		R <sub>L</sub> = 5k, V <sub>IN</sub> = ±10mV	±2.5V	1.1			±V
I <sub>OUT</sub>	Output Current	V <sub>OUT</sub> = ±10V	±15V	10.0			mA
		V <sub>OUT</sub> = ±3.2V	±5V	6.4			mA
I <sub>SC</sub>	Short-Circuit Current	V <sub>OUT</sub> = 0V, V <sub>IN</sub> = ±3V	±15V	20			mA
SR	Slew Rate	A <sub>V</sub> = -1, R <sub>L</sub> = 5k (Note 4)	±15V	50			V/μs
			±5V	15			V/μs
GBW	Gain Bandwidth	f = 200kHz, R <sub>L</sub> = 10k	±15V	1.6			MHz
			±5V	1.4			MHz
	Channel Separation	V <sub>OUT</sub> = ±10V, R <sub>L</sub> = 2k	±15V	99			dB
I <sub>S</sub>	Supply Current	Each Amplifier	±15V			380	μA
			±5V			350	μA

**Note 1:** Absolute Maximum Ratings are those values beyond which the life of a device may be impaired.

**Note 2:** Differential inputs of ±10V are appropriate for transient operation only, such as during slewing. Large, sustained differential inputs will cause excessive power dissipation and may damage the part. See Input Considerations in the Applications Information section of this data sheet for more details.

**Note 3:** A heat sink may be required to keep the junction temperature below absolute maximum when the output is shorted indefinitely.

**Note 4:** Slew rate is measured between ±8V on the output with ±12V

input for ±15V supplies and ±2V on the output with ±3V input for ±5V supplies.

**Note 5:** Full-power bandwidth is calculated from the slew rate measurement:  $\text{FPBW} = (\text{Slew Rate})/2\pi V_P$ .

**Note 6:** This parameter is not 100% tested.

**Note 7:** The LT1352C/LT1353C are guaranteed to meet specified performance from 0°C to 70°C. The LT1352C/LT1353C are designed, characterized and expected to meet specified performance from -40°C to 85°C but are not tested or QA sampled at these temperatures. The LT1352I/LT1353I are guaranteed to meet specified performance from -40°C to 85°C.

**TYPICAL PERFORMANCE CHARACTERISTICS**

Supply Current vs Supply Voltage and Temperature

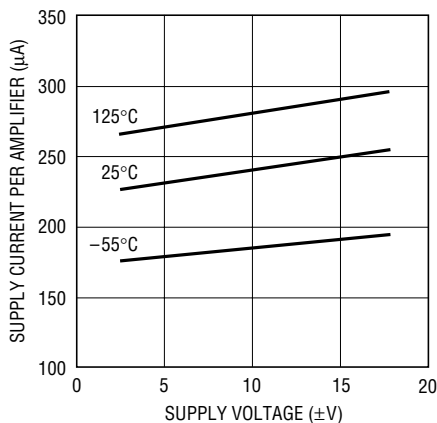

1352/53 G01

Input Common Mode Range vs Supply Voltage

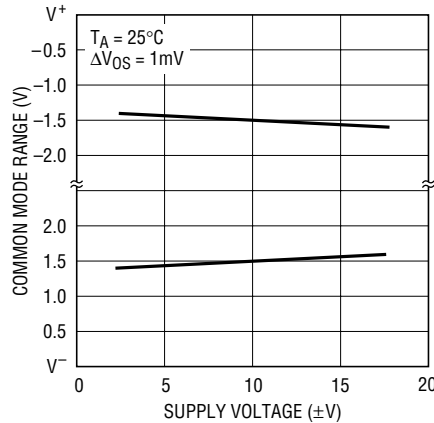

1352/53 G02

Input Bias Current vs Input Common Mode Voltage

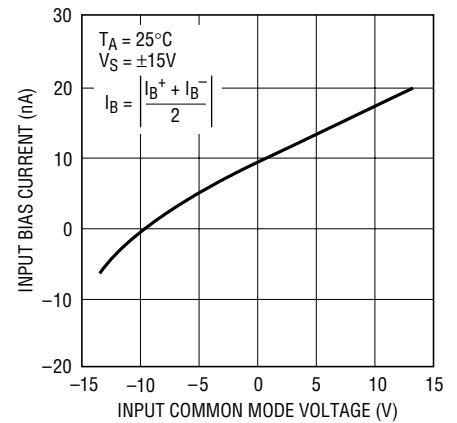

1352/53 G03

# TYPICAL PERFORMANCE CHARACTERISTICS

**Input Bias Current vs Temperature**

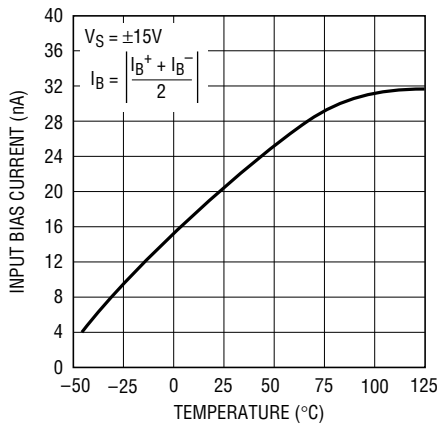

1352/53 G04

**Input Noise Spectral Density**

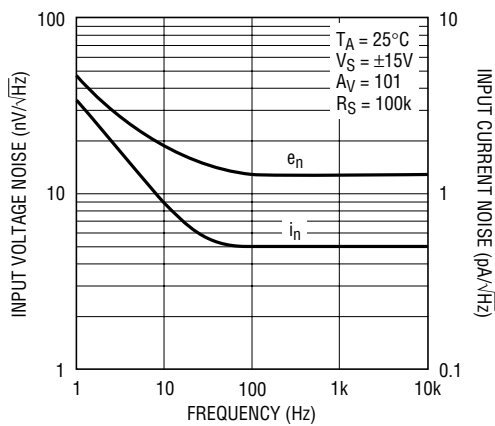

1352/53 G05

**Open-Loop Gain vs Resistive Load**

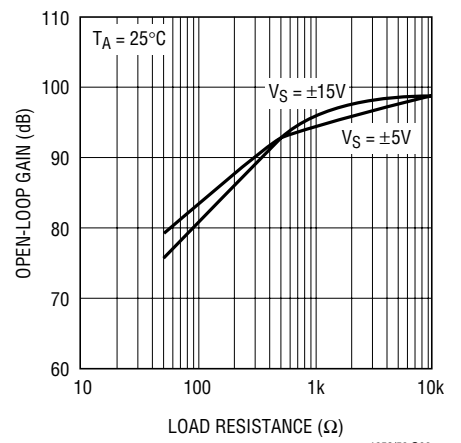

1352/53 G06

**Open-Loop Gain vs Temperature**

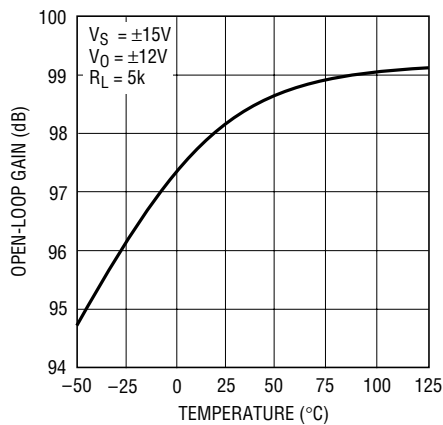

1352/53 G07

**Output Voltage Swing vs Supply Voltage**

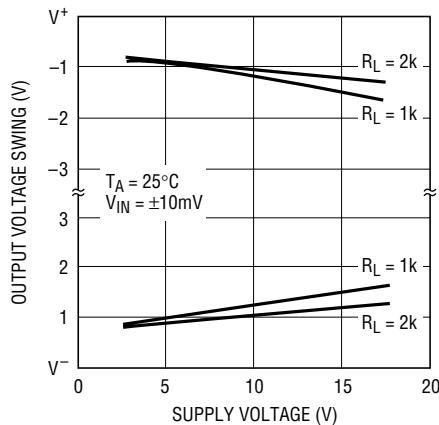

1352/53 G08

**Output Voltage Swing vs Load Current**

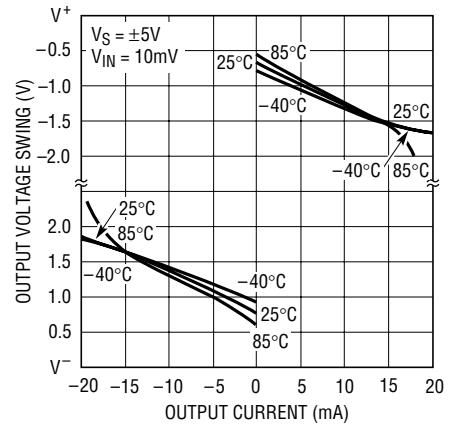

1352/53 G09

**Output Short-Circuit Current vs Temperature**

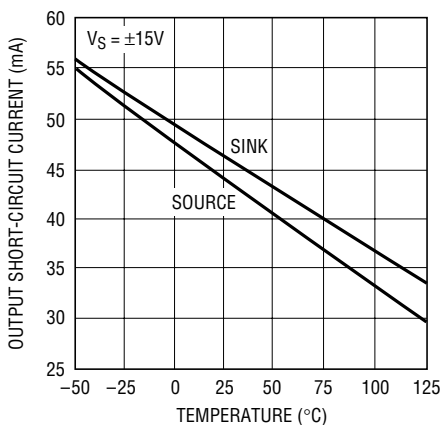

1352/53 G10

**Settling Time vs Output Step (Noninverting)**

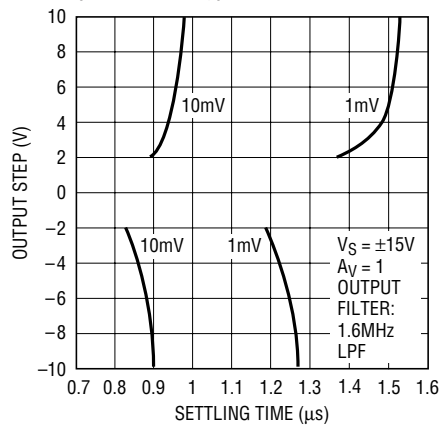

1352/53 G11

**Settling Time vs Output Step (Inverting)**

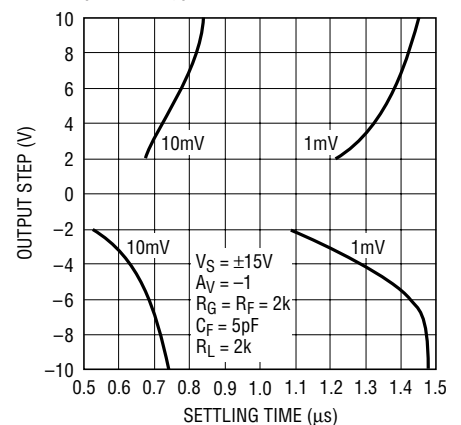

1352/53 G12

# TYPICAL PERFORMANCE CHARACTERISTICS

**Gain and Phase vs Frequency**

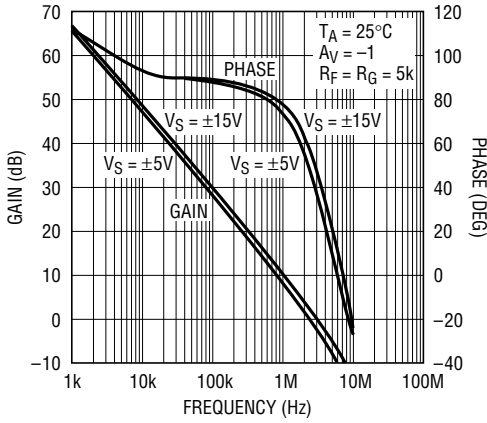

1352/53 G13

**Output Impedance vs Frequency**

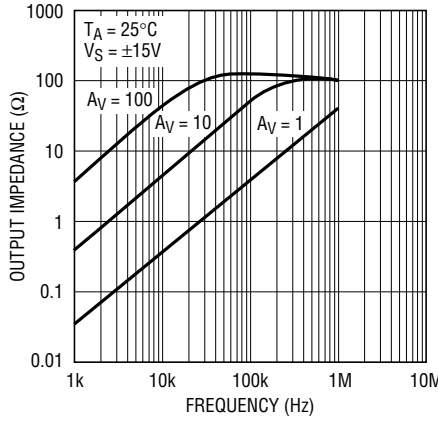

1352/53 G14

**Frequency Response vs Capacitive Load**

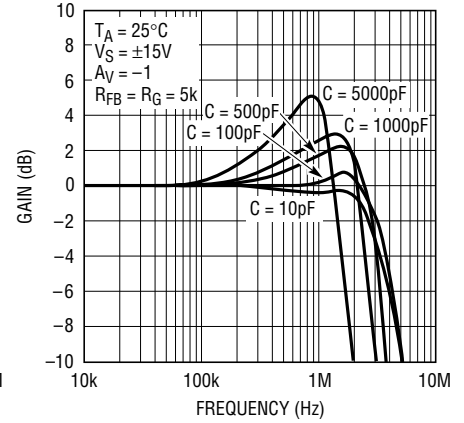

1352/53 G15

**Gain Bandwidth and Phase Margin vs Temperature**

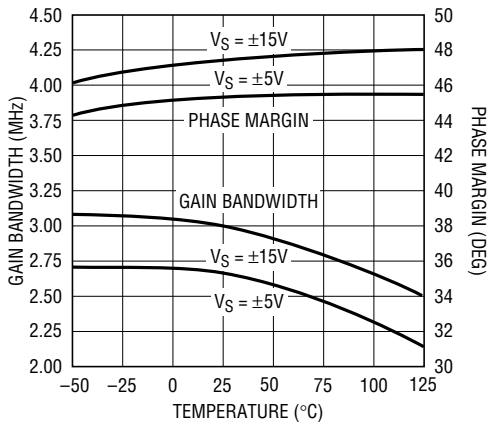

1352/53 G16

**Frequency Response vs Supply Voltage (AV = 1)**

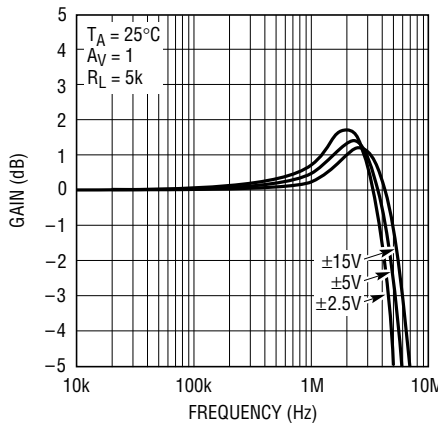

1352/53 G17

**Frequency Response vs Supply Voltage (AV = -1)**

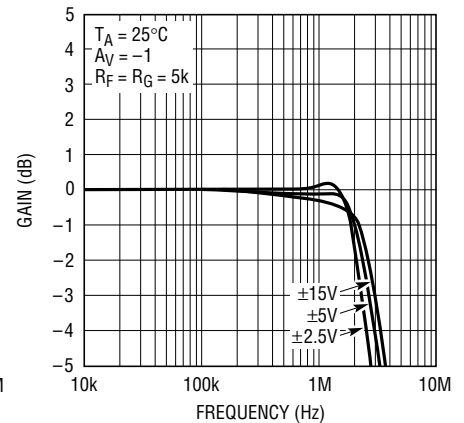

1352/53 G18

**Gain Bandwidth and Phase Margin vs Supply Voltage**

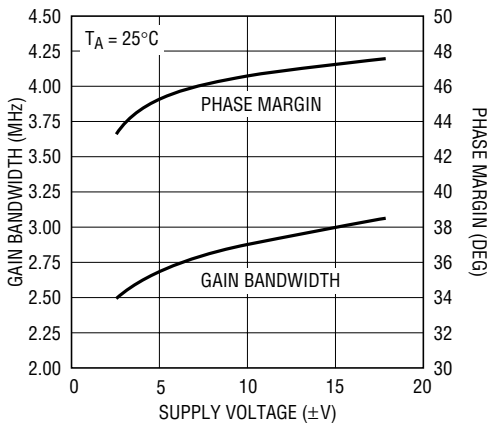

1352/53 G19

**Power Supply Rejection Ratio vs Frequency**

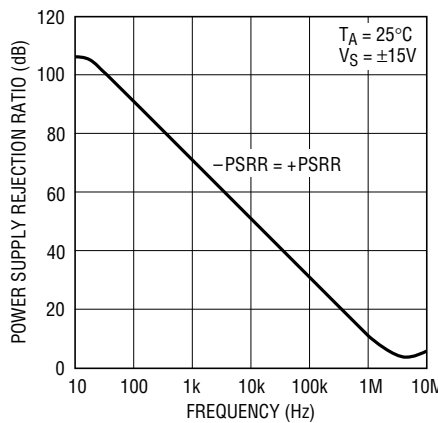

1352/53 G20

**Common Mode Rejection Ratio vs Frequency**

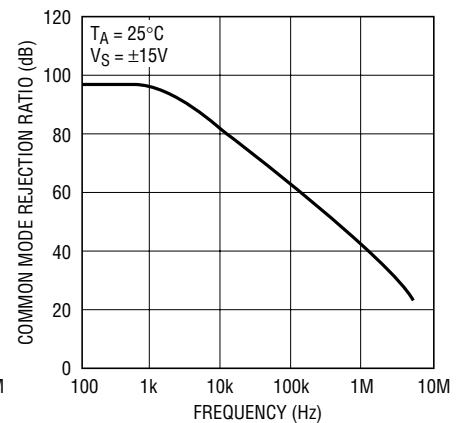

1352/53 G21

# TYPICAL PERFORMANCE CHARACTERISTICS

**Slew Rate vs Supply Voltage**

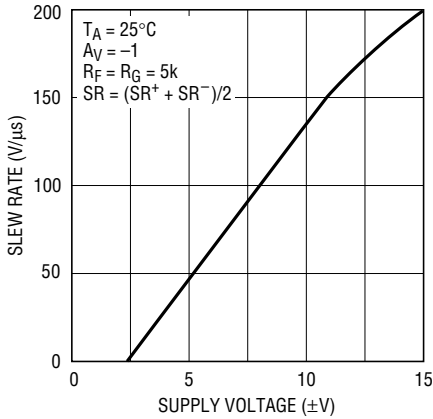

1352/53 G22

**Slew Rate vs Temperature**

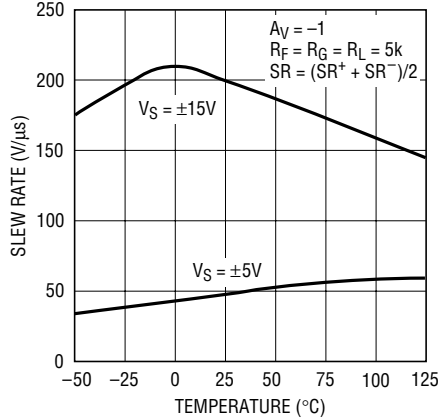

1352/53 G23

**Slew Rate vs Input Level**

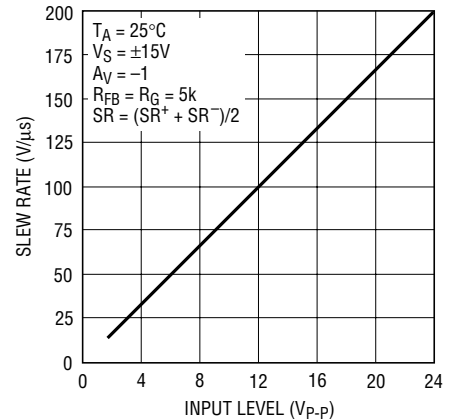

1352/53 G24

**Total Harmonic Distortion vs Frequency**

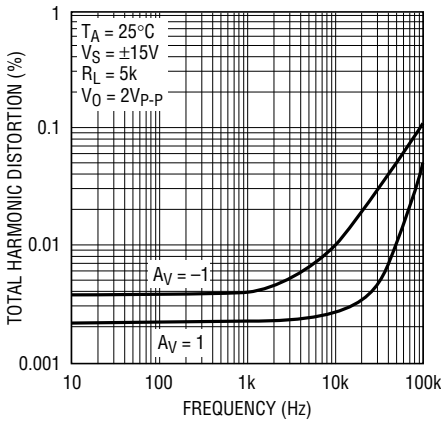

1352/53 G25

**Undistorted Output Swing vs Frequency (±15V)**

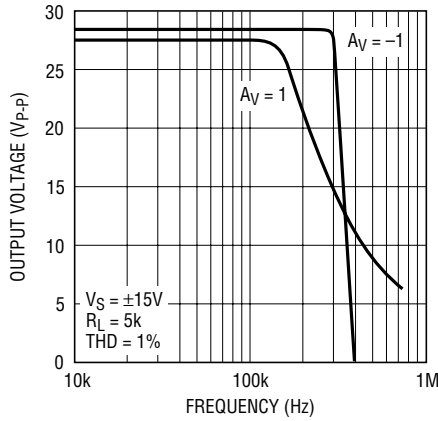

1352/53 G26

**Undistorted Output Swing vs Frequency (±5V)**

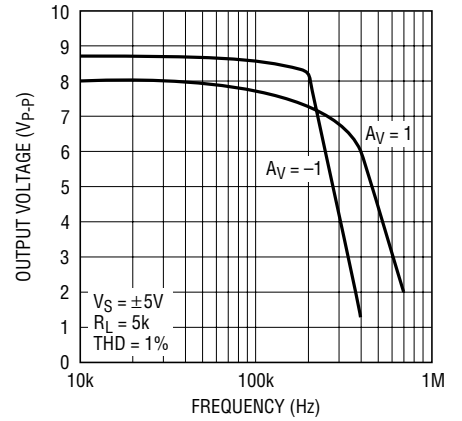

1352/53 G27

**2nd and 3rd Harmonic Distortion vs Frequency**

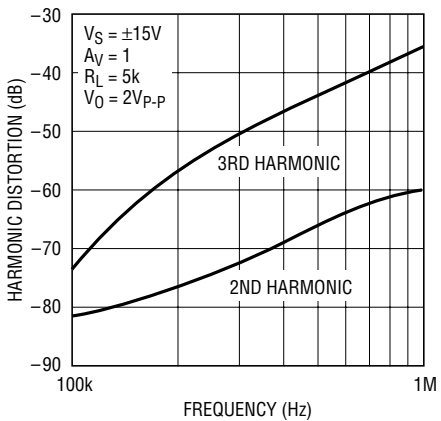

1352/53 G28

**Crosstalk vs Frequency**

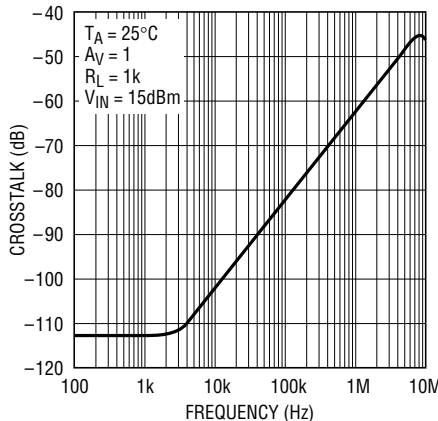

1352/53 G29

**Capacitive Load Handling**

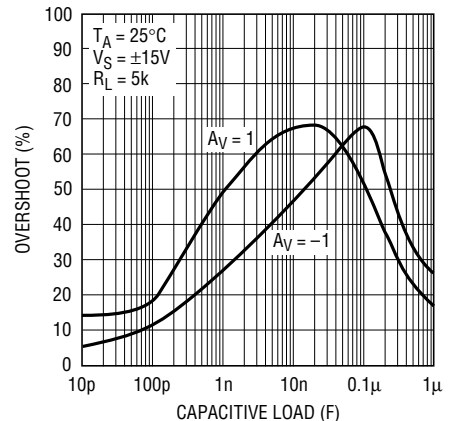

1352/53 G30



## TYPICAL PERFORMANCE CHARACTERISTICS

Small-Signal Transient  
( $A_V = 1$ )

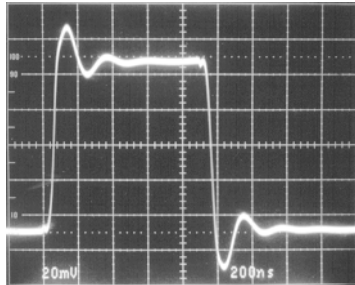

1352/53 G31

Small-Signal Transient  
( $A_V = -1$ )

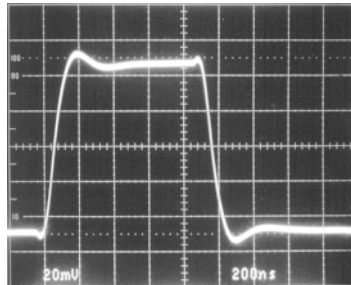

1352/53 G32

Small-Signal Transient  
( $A_V = -1, C_L = 1000\text{pF}$ )

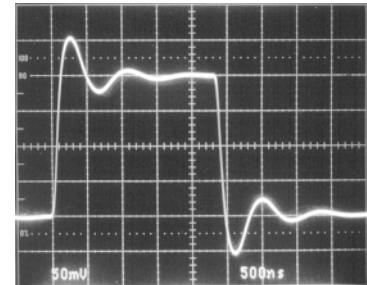

1352/53 G33

Large-Signal Transient  
( $A_V = 1$ )

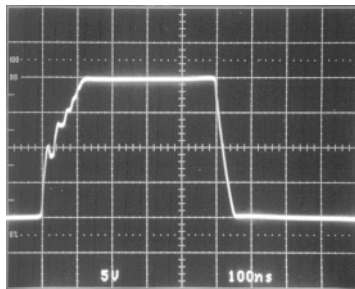

1352/53 G34

Large-Signal Transient  
( $A_V = -1$ )

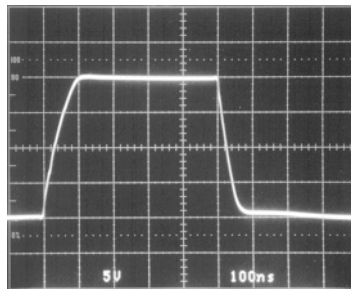

1352/53 G35

Large-Signal Transient  
( $A_V = 1, C_L = 10,000\text{pF}$ )

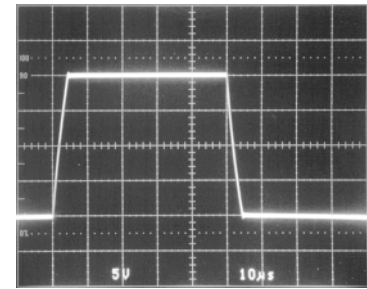

1352/53 G36

## APPLICATIONS INFORMATION

### Layout and Passive Components

The LT1352/LT1353 amplifiers are easy to use and tolerant of less than ideal layouts. For maximum performance (for example, fast 0.01% settling) use a ground plane, short lead lengths and RF-quality bypass capacitors (0.01 $\mu\text{F}$  to 0.1 $\mu\text{F}$ ). For high drive current applications use low ESR bypass capacitors (1 $\mu\text{F}$  to 10 $\mu\text{F}$  tantalum).

The parallel combination of the feedback resistor and gain setting resistor on the inverting input can combine with the input capacitance to form a pole which can cause peaking or even oscillations. If feedback resistors greater than 10k are used, a parallel capacitor of value,  $C_F > (R_G)(C_{IN}/R_F)$ , should be used to cancel the input pole and optimize dynamic performance. For applications where the DC noise gain is one and a large feedback resistor is used,  $C_F$  should be greater than or equal to  $C_{IN}$ . An example would be an I-to-V converter as shown in the Typical Applications section.

### Capacitive Loading

The LT1352/LT1353 are stable with any capacitive load. As the capacitive load increases, both the bandwidth and phase margin decrease so there will be peaking in the frequency domain and in the transient response. Graphs of Frequency Response vs Capacitive Load, Capacitive Load Handling and the transient response photos clearly show these effects.

### Input Considerations

Each of the LT1352/LT1353 inputs is the base of an NPN and a PNP transistor whose base currents are of opposite polarity and provide first-order bias current cancellation. Because of variation in the matching of NPN and PNP beta, the polarity of the input bias current can be positive or negative. The offset current does not depend on NPN/PNP beta matching and is well controlled. The use of balanced source resistance at each input is recommended for

13523fa

## APPLICATIONS INFORMATION

applications where DC accuracy must be maximized. The inputs can withstand transient differential input voltages up to 10V without damage and need no clamping or source resistance for protection. Differential inputs, however, generate large supply currents (tens of mA) as required for high slew rates. If the device is used with sustained differential inputs, the average supply current will increase, excessive power dissipation will result and the part may be damaged. **The part should not be used as a comparator, peak detector or other open-loop application with large, sustained differential inputs.** Under normal, closed-loop operation, an increase of power dissipation is only noticeable in applications with large slewing outputs and is proportional to the magnitude of the differential input voltage and the percent of time that the inputs are apart. Measure the average supply current for the application in order to calculate the power dissipation.

### Circuit Operation

The LT1352/LT1353 circuit topology is a true voltage feedback amplifier that has the slewing behavior of a current feedback amplifier. The operation of the circuit can be understood by referring to the Simplified Schematic.

The inputs are buffered by complementary NPN and PNP emitter followers which drive R1, a 1k resistor. The input voltage appears across the resistor generating currents which are mirrored into the high impedance node and compensation capacitor  $C_T$ . Complementary followers form an output stage which buffers the gain node from the load. The output devices Q19 and Q22 are connected to form a composite PNP and a composite NPN.

The bandwidth is set by the input resistor and the capacitance on the high impedance node. The slew rate is determined by the current available to charge the high impedance node capacitance. This current is the differential input voltage divided by R1, so the slew rate is proportional to the input. Highest slew rates are therefore seen in the lowest gain configurations. For example, a 10V output step in a gain of 10 has only a 1V input step whereas the same output step in unity gain has a 10 times greater

input step. The graph Slew Rate vs Input Level illustrates this relationship. In higher gain configurations the large-signal performance and the small-signal performance both look like a single pole response.

Capacitive load compensation is provided by the  $R_C$ ,  $C_C$  network which is bootstrapped across the output stage. When the amplifier is driving a light load the network has no effect. When driving a capacitive load (or a low value resistive load) the network is incompletely bootstrapped and adds to the compensation at the high impedance node. The added capacitance slows down the amplifier and a zero is created by the RC combination, both of which improve the phase margin. The design ensures that even for very large load capacitances, the total phase lag can never exceed 180 degrees (zero phase margin) and the amplifier remains stable.

### Power Dissipation

The LT1352/LT1353 combine high speed and large output drive in small packages. Because of the wide supply voltage range, it is possible to exceed the maximum junction temperature of 150°C under certain conditions. Maximum junction temperature  $T_J$  is calculated from the ambient temperature  $T_A$  and power dissipation  $P_D$  as follows:

$$\begin{aligned} \text{LT1352CN8: } T_J &= T_A + (P_D)(130^\circ\text{C/W}) \\ \text{LT1352CS8: } T_J &= T_A + (P_D)(190^\circ\text{C/W}) \\ \text{LT1353CS: } T_J &= T_A + (P_D)(150^\circ\text{C/W}) \end{aligned}$$

Worst-case power dissipation occurs at the maximum supply current and when the output voltage is at 1/2 of either supply voltage (or the maximum swing if less than 1/2 supply voltage). For each amplifier  $P_{D(\text{MAX})}$  is:

$$P_{D(\text{MAX})} = (V^+ - V^-)(I_{S(\text{MAX})}) + (V^+/2)^2/R_L \text{ or } (V^+ - V^-)(I_{S(\text{MAX})}) + (V^+ - V_{\text{MAX}})(I_{\text{MAX}})$$

Example: LT1353 in S14 at 85°C,  $V_S = \pm 15\text{V}$ ,  $R_L = 500\Omega$ ,  $V_{\text{OUT}} = \pm 5\text{V}$  ( $\pm 10\text{mA}$ )

$$\begin{aligned} P_{D(\text{MAX})} &= (30\text{V})(380\mu\text{A}) + (15\text{V} - 5\text{V})(10\text{mA}) = 111\text{mW} \\ T_J &= 85^\circ\text{C} + (4)(111\text{mW})(150^\circ\text{C/W}) = 152^\circ\text{C} \end{aligned}$$

**SIMPLIFIED SCHEMATIC**

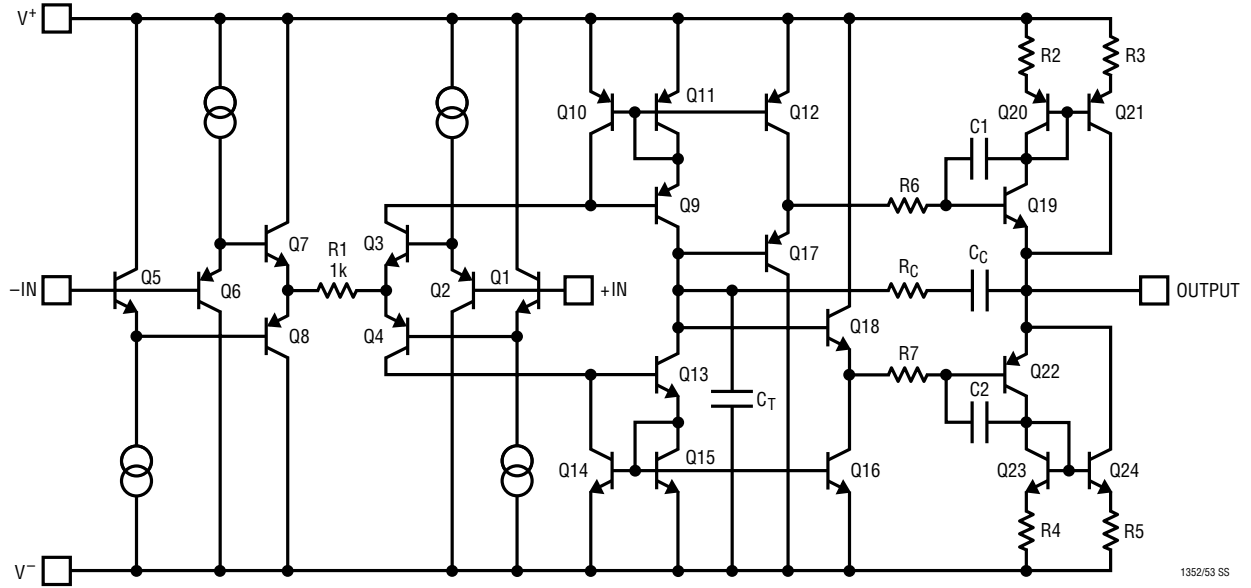

TYPICAL APPLICATIONS

DAC I-to-V Converter

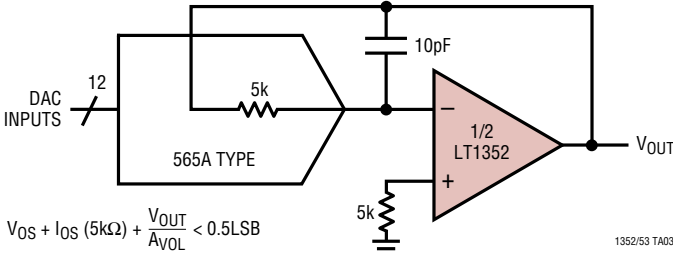

400kHz Photodiode Preamp with 10kHz Highpass Loop

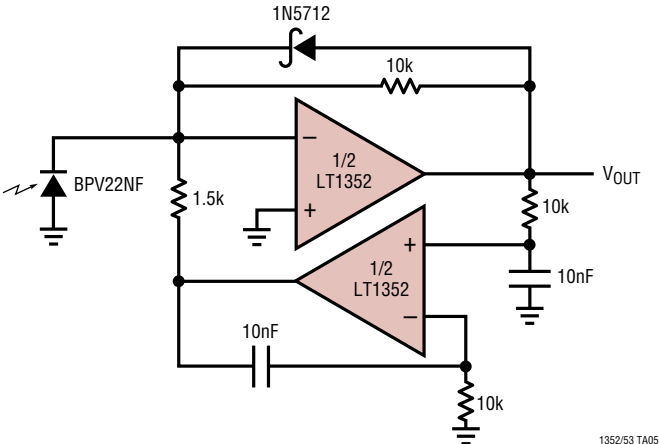

# PACKAGE DESCRIPTION

**N8 Package**  
**8-Lead PDIP (Narrow .300 Inch)**  
 (Reference LTC DWG # 05-08-1510)

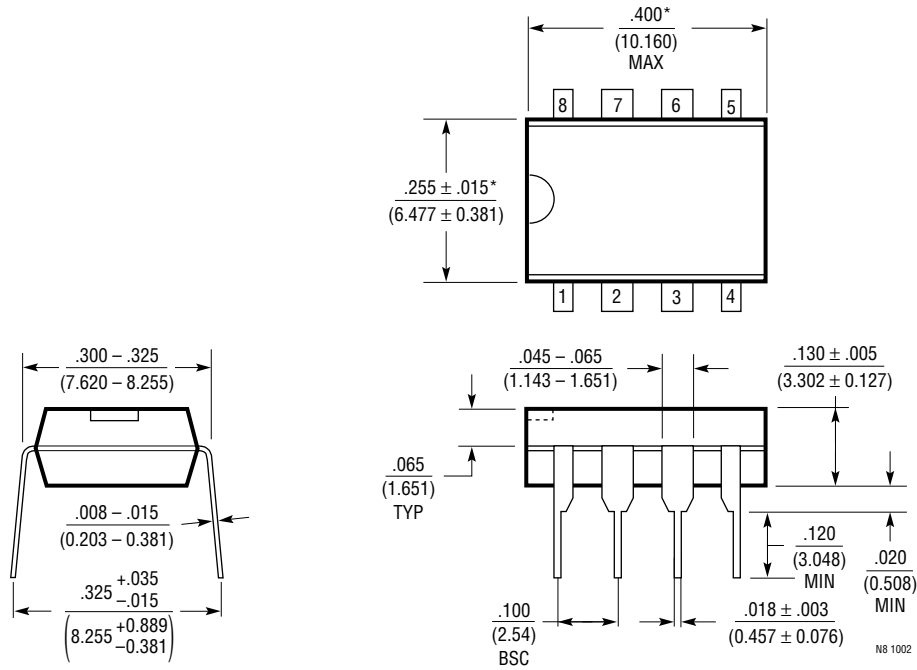

NOTE:  
 1. DIMENSIONS ARE  $\frac{\text{INCHES}}{\text{MILLIMETERS}}$   
 \*THESE DIMENSIONS DO NOT INCLUDE MOLD FLASH OR PROTRUSIONS.  
 MOLD FLASH OR PROTRUSIONS SHALL NOT EXCEED .010 INCH (0.254mm)

N8 1002

**PACKAGE DESCRIPTION**

**S8 Package**  
**8-Lead Plastic Small Outline (Narrow .150 Inch)**  
 (Reference LTC DWG # 05-08-1610)

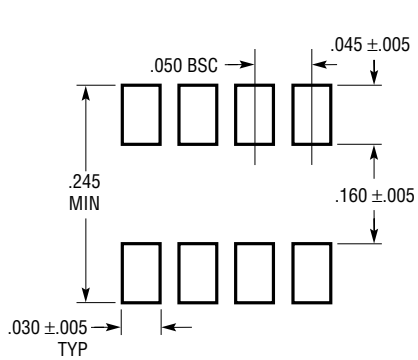

RECOMMENDED SOLDER PAD LAYOUT

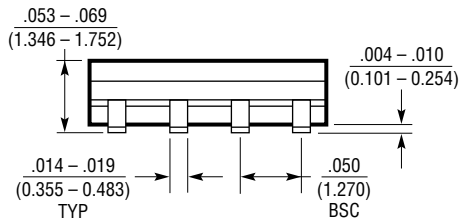
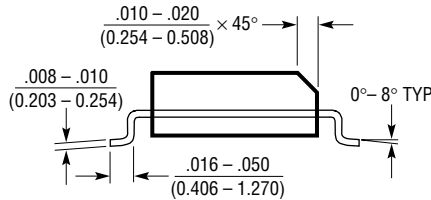
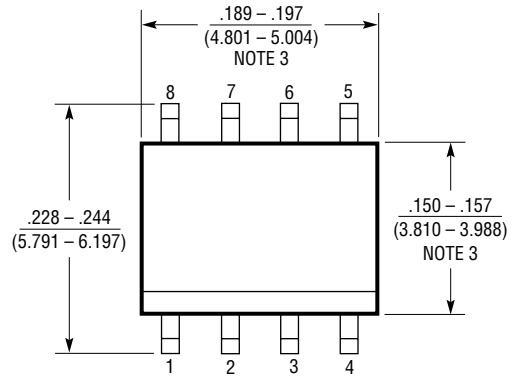

- NOTE:  
 1. DIMENSIONS IN  $\frac{\text{INCHES}}{\text{MILLIMETERS}}$   
 2. DRAWING NOT TO SCALE  
 3. THESE DIMENSIONS DO NOT INCLUDE MOLD FLASH OR PROTRUSIONS.  
 MOLD FLASH OR PROTRUSIONS SHALL NOT EXCEED .006" (0.15mm)

S08 0303

# PACKAGE DESCRIPTION

## S Package 14-Lead Plastic Small Outline (Narrow .150 Inch) (Reference LTC DWG # 05-08-1610)

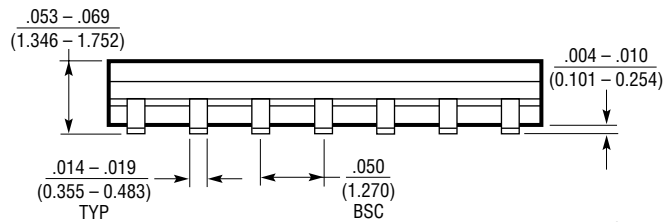
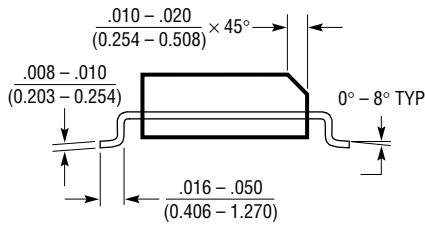
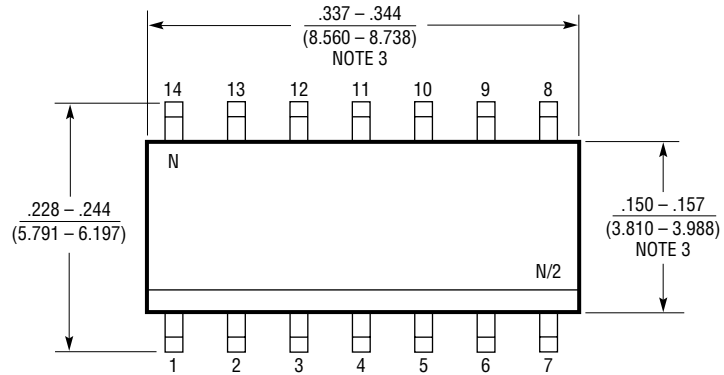
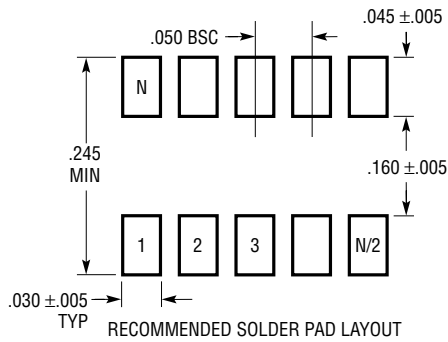

- NOTE:  
 1. DIMENSIONS IN  $\frac{\text{INCHES}}{\text{MILLIMETERS}}$   
 2. DRAWING NOT TO SCALE  
 3. THESE DIMENSIONS DO NOT INCLUDE MOLD FLASH OR PROTRUSIONS.  
 MOLD FLASH OR PROTRUSIONS SHALL NOT EXCEED .006" (0.15mm)

S14 0502

## TYPICAL APPLICATIONS

20kHz, 4th Order Butterworth Filter

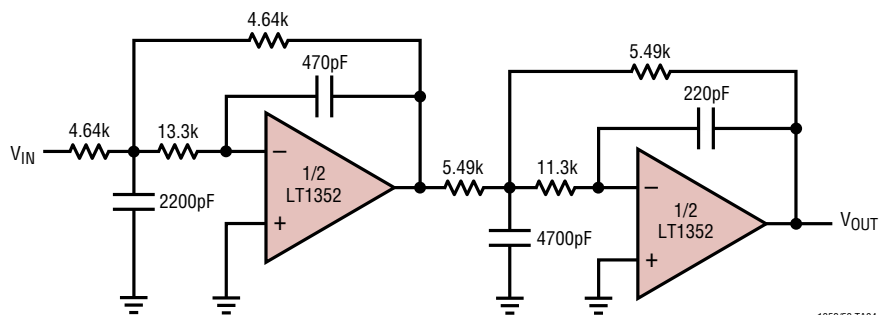

1352/53 TA04

## RELATED PARTS

PART NUMBER	DESCRIPTION	COMMENTS
LT1351	250 $\mu$ A, 3MHz, 200V/ $\mu$ s Op Amp	Good DC Precision, C-Load Stable, Power Saving Shutdown
LT1354/55/56	Single/Dual/Quad 1mA, 12MHz, 400V/ $\mu$ s Op Amp	Good DC Precision, Stable with All Capacitive Loads