

FEATURES

- Gain of 25 Stable
- 1GHz Gain Bandwidth
- 400V/ μ s Slew Rate
- 2.6nV/ $\sqrt{\text{Hz}}$ Input Noise Voltage
- 50V/mV Minimum DC Gain, $R_L = 500\Omega$
- 1mV Maximum Input Offset Voltage
- $\pm 12\text{V}$ Minimum Output Swing into 500Ω
- Wide Supply Range $\pm 2.5\text{V}$ to $\pm 15\text{V}$
- 7mA Supply Current
- 100ns Settling Time to 0.1%, 10V Step
- Drives All Capacitive Loads

APPLICATIONS

- Wideband Amplifiers
- Buffers
- Active Filters
- Video and RF Amplification
- Cable Drivers
- Data Acquisition Systems

DESCRIPTION

The LT1226 is a low noise, very high speed operational amplifier with excellent DC performance. The LT1226 features low input offset voltage and high DC gain. The circuit is a single gain stage with outstanding settling characteristics. The fast settling time makes the circuit an ideal choice for data acquisition systems. The output is capable of driving a 500Ω load to $\pm 12\text{V}$ with $\pm 15\text{V}$ supplies and a 150Ω load to $\pm 3\text{V}$ on $\pm 5\text{V}$ supplies. The circuit is also capable of driving large capacitive loads which makes it useful in buffer or cable driver applications.

The LT1226 is a member of a family of fast, high performance amplifiers that employ Linear Technology Corporation's advanced bipolar complementary processing.

TYPICAL APPLICATION

Photodiode Preamplifier, $A_V = 5.1\text{k}\Omega$, $\text{BW} = 15\text{MHz}$

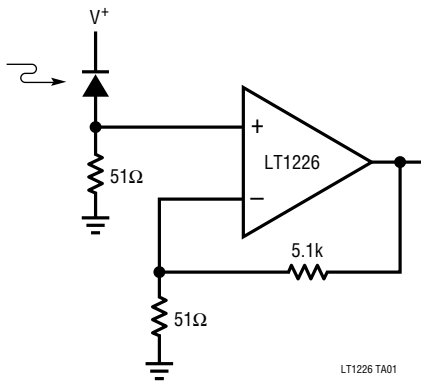

Gain of +25 Pulse Response

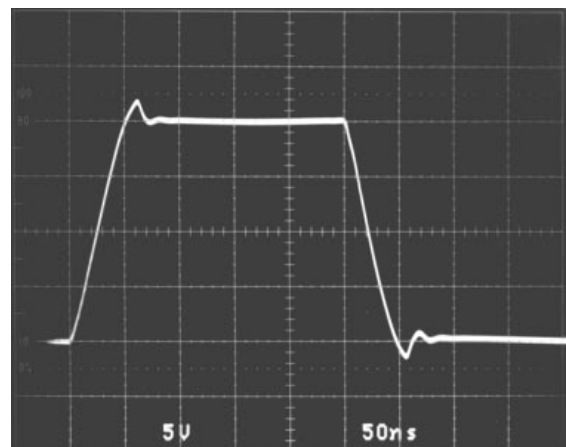

ABSOLUTE MAXIMUM RATINGS

| | |
|---|-----------------|
| Total Supply Voltage (V^+ to V^-) | 36V |
| Differential Input Voltage | $\pm 6V$ |
| Input Voltage | $\pm V_S$ |
| Output Short Circuit Duration (Note 1) | Indefinite |
| Operating Temperature Range | |
| LT1226C | 0°C to 70°C |
| Maximum Junction Temperature | |
| Plastic Package | 150°C |
| Storage Temperature Range | - 65°C to 150°C |
| Lead Temperature (Soldering, 10 sec.) | 300°C |

PACKAGE/ORDER INFORMATION

| | |
|---|------------------------|
| <p>TOP VIEW</p> <p>N8 PACKAGE 8-LEAD PLASTIC DIP</p> <p>S8 PACKAGE 8-LEAD PLASTIC SOIC</p> <p>LT1226 P001</p> | ORDER PART NUMBER |
| | LT1226CN8 LT1226CS8 |
| | S8 PART MARKING |
| | 1226 |

ELECTRICAL CHARACTERISTICS $V_S = \pm 15V$, $T_A = 25^\circ C$, $V_{CM} = 0V$ unless otherwise noted.

| SYMBOL | PARAMETER | CONDITIONS | MIN | TYP | MAX | UNITS |
|---------------|------------------------------|---|------|----------|-----|--------------------------|
| V_{OS} | Input Offset Voltage | (Note 2) | | 0.3 | 1.0 | mV |
| I_{OS} | Input Offset Current | | | 100 | 400 | nA |
| I_B | Input Bias Current | | | 4 | 8 | μA |
| e_n | Input Noise Voltage | $f = 10kHz$ | | 2.6 | | nV/\sqrt{Hz} |
| i_n | Input Noise Current | $f = 10kHz$ | | 1.5 | | pA/\sqrt{Hz} |
| R_{IN} | Input Resistance | $V_{CM} = \pm 12V$ Differential | 24 | 40 15 | | M Ω k Ω |
| C_{IN} | Input Capacitance | | | 2 | | pF |
| | Input Voltage Range + | | 12 | 14 | | V |
| | Input Voltage Range - | | | -13 | -12 | V |
| CMRR | Common-Mode Rejection Ratio | $V_{CM} = \pm 12V$ | 94 | 103 | | dB |
| PSRR | Power Supply Rejection Ratio | $V_S = \pm 5V$ to $\pm 15V$ | 94 | 110 | | dB |
| A_{VOL} | Large Signal Voltage Gain | $V_{OUT} = \pm 10V$, $R_L = 500\Omega$ | 50 | 150 | | V/mV |
| V_{OUT} | Output Swing | $R_L = 500\Omega$ | 12.0 | 13.3 | | $\pm V$ |
| I_{OUT} | Output Current | $V_{OUT} = \pm 12V$ | 24 | 40 | | mA |
| SR | Slew Rate | (Note 3) | 250 | 400 | | V/ μs |
| | Full Power Bandwidth | 10V Peak, (Note 4) | | 6.4 | | MHz |
| GBW | Gain Bandwidth | $f = 1MHz$ | | 1 | | GHz |
| t_r , t_f | Rise Time, Fall Time | $A_{VCL} = +25$, 10% to 90%, 0.1V | | 5.5 | | ns |
| | Overshoot | $A_{VCL} = +25$, 0.1V | | 35 | | % |
| | Propagation Delay | 50% V_{IN} to 50% V_{OUT} | | 5.5 | | ns |
| t_s | Settling Time | 10V Step, 0.1%, $A_V = -25$ | | 100 | | ns |
| | Differential Gain | $f = 3.58MHz$, $A_V = +25$, $R_L = 150\Omega$ | | 0.7 | | % |
| | Differential Phase | $f = 3.58MHz$, $A_V = +25$, $R_L = 150\Omega$ | | 0.6 | | Deg |
| R_O | Output Resistance | $A_{VCL} = +25$, $f = 1MHz$ | | 3.1 | | Ω |
| I_S | Supply Current | | | 7 | 9 | mA |

ELECTRICAL CHARACTERISTICS $V_S = \pm 5V$, $T_A = 25^\circ C$, $V_{CM} = 0V$ unless otherwise noted.

| SYMBOL | PARAMETER | CONDITIONS | MIN | TYP | MAX | UNITS |
|------------|-----------------------------|--|------------|------------|------|--------------------|
| V_{OS} | Input Offset Voltage | (Note 2) | | 1.0 | 1.4 | mV |
| I_{OS} | Input Offset Current | | | 100 | 400 | nA |
| I_B | Input Bias Current | | | 4 | 8 | μA |
| | Input Voltage Range + | | 2.5 | 4 | | V |
| | Input Voltage Range - | | | -3 | -2.5 | V |
| CMRR | Common-Mode Rejection Ratio | $V_{CM} = \pm 2.5V$ | 94 | 103 | | dB |
| A_{VOL} | Large Signal Voltage Gain | $V_{OUT} = \pm 2.5V$, $R_L = 500\Omega$ $V_{OUT} = \pm 2.5V$, $R_L = 150\Omega$ | 50 | 100 75 | | V/mV V/mV |
| V_{OUT} | Output Voltage | $R_L = 500\Omega$ $R_L = 150\Omega$ | 3.0 3.0 | 3.7 3.3 | | $\pm V$ $\pm V$ |
| I_{OUT} | Output Current | $V_{OUT} = \pm 3V$ | 20 | 40 | | mA |
| SR | Slew Rate | (Note 3) | | 250 | | V/ μs |
| | Full Power Bandwidth | 3V Peak, (Note 4) | | 13.3 | | MHz |
| GBW | Gain Bandwidth | $f = 1MHz$ | | 700 | | MHz |
| t_r, t_f | Rise Time, Fall Time | $A_{VCL} = +25$, 10% to 90%, 0.1V | | 8 | | ns |
| | Overshoot | $A_{VCL} = +25$, 0.1V | | 25 | | % |
| | Propagation Delay | 50% V_{IN} to 50% V_{OUT} | | 8 | | ns |
| t_s | Settling Time | -2.5V to 2.5V, 0.1%, $A_V = -24$ | | 60 | | ns |
| I_S | Supply Current | | | 7 | 9 | mA |

ELECTRICAL CHARACTERISTICS $0^\circ C \leq T_A \leq 70^\circ C$, $V_{CM} = 0V$ unless otherwise noted.

| SYMBOL | PARAMETER | CONDITIONS | MIN | TYP | MAX | UNITS |
|-----------|------------------------------|--|-------------|-------------|------------|--------------------|
| V_{OS} | Input Offset Voltage | $V_S = \pm 15V$, (Note 2) $V_S = \pm 5V$, (Note 2) | | 0.3 1.0 | 1.3 1.8 | mV mV |
| | Input V_{OS} Drift | | | 6 | | $\mu V/^\circ C$ |
| I_{OS} | Input Offset Current | $V_S = \pm 15V$ and $V_S = \pm 5V$ | | 100 | 600 | nA |
| I_B | Input Bias Current | $V_S = \pm 15V$ and $V_S = \pm 5V$ | | 4 | 9 | μA |
| CMRR | Common-Mode Rejection Ratio | $V_S = \pm 15V$, $V_{CM} = \pm 12V$ and $V_S = \pm 5V$, $V_{CM} = \pm 2.5V$ | 92 | 103 | | dB |
| PSRR | Power Supply Rejection Ratio | $V_S = \pm 5V$ to $\pm 15V$ | 92 | 110 | | dB |
| A_{VOL} | Large Signal Voltage Gain | $V_S = \pm 15V$, $V_{OUT} = \pm 10V$, $R_L = 500\Omega$ $V_S = \pm 5V$, $V_{OUT} = \pm 2.5V$, $R_L = 500\Omega$ | 35 35 | 150 100 | | V/mV V/mV |
| V_{OUT} | Output Swing | $V_S = \pm 15V$, $R_L = 500\Omega$ $V_S = \pm 5V$, $R_L = 500\Omega$ or 150Ω | 12.0 3.0 | 13.3 3.3 | | $\pm V$ $\pm V$ |
| I_{OUT} | Output Current | $V_S = \pm 15V$, $V_{OUT} = \pm 12V$ $V_S = \pm 5V$, $V_{OUT} = \pm 3V$ | 24 20 | 40 40 | | mA mA |
| SR | Slew Rate | $V_S = \pm 15V$, (Note 3) | 250 | 400 | | V/ μs |
| I_S | Supply Current | $V_S = \pm 15V$ and $V_S = \pm 5V$ | | 7 | 10.5 | mA |

Note 1: A heat sink may be required to keep the junction temperature below absolute maximum when the output is shorted indefinitely.

Note 2: Input offset voltage is tested with automated test equipment in <1 second.

Note 3: Slew rate is measured between $\pm 10V$ on an output swing of $\pm 12V$ on $\pm 15V$ supplies, and $\pm 2V$ on an output swing of $\pm 3.5V$ on $\pm 5V$ supplies.

Note 4: Full power bandwidth is calculated from the slew rate measurement: $FPBW = SR/2\pi V_p$.

TYPICAL PERFORMANCE CHARACTERISTICS

Input Common Mode Range vs Supply Voltage

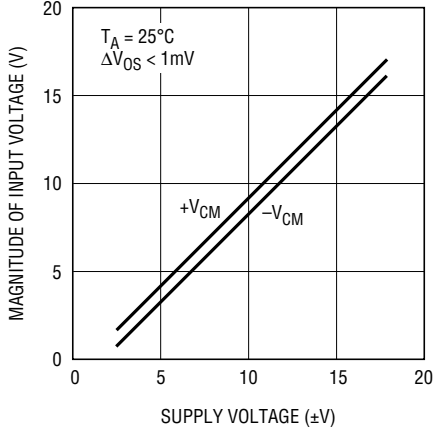

Supply Current vs Supply Voltage

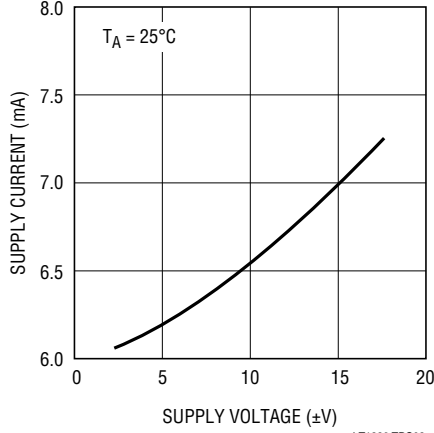

Output Voltage Swing vs Supply Voltage

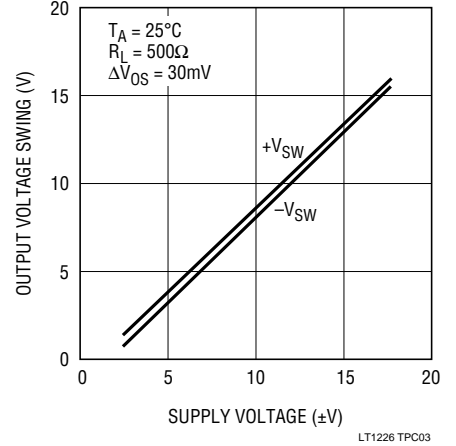

Output Voltage Swing vs Resistive Load

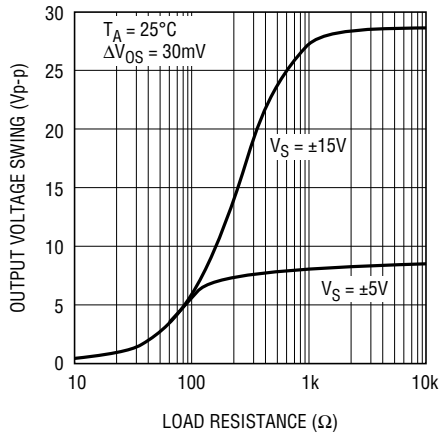

Input Bias Current vs Input Common Mode Voltage

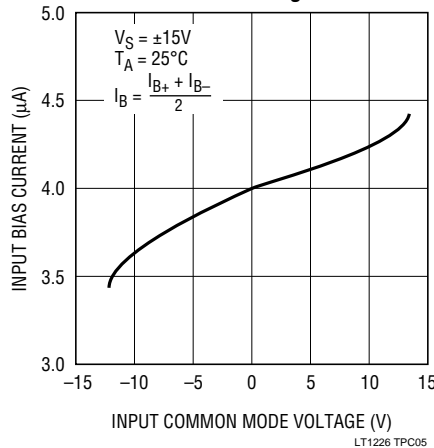

Open Loop Gain vs Resistive Load

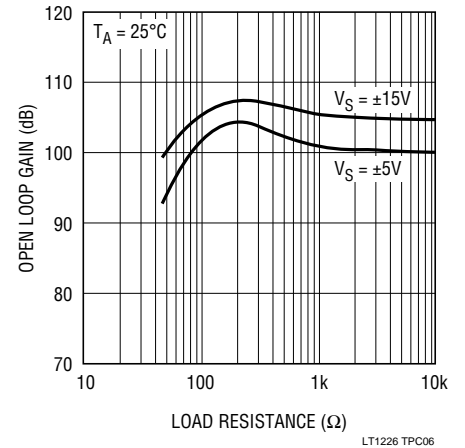

Supply Current vs Temperature

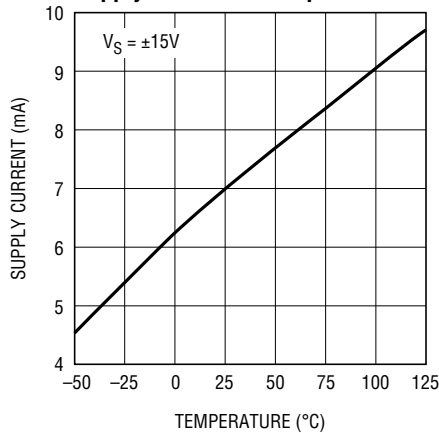

Input Bias Current vs Temperature

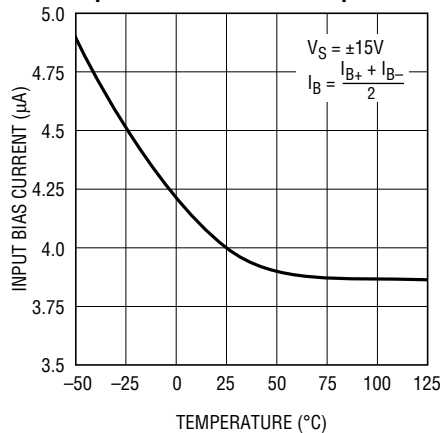

Output Short Circuit Current vs Temperature

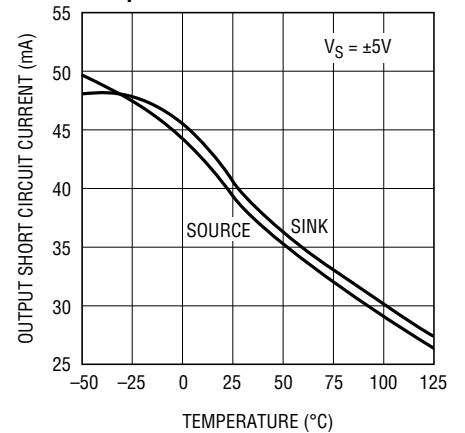

TYPICAL PERFORMANCE CHARACTERISTICS

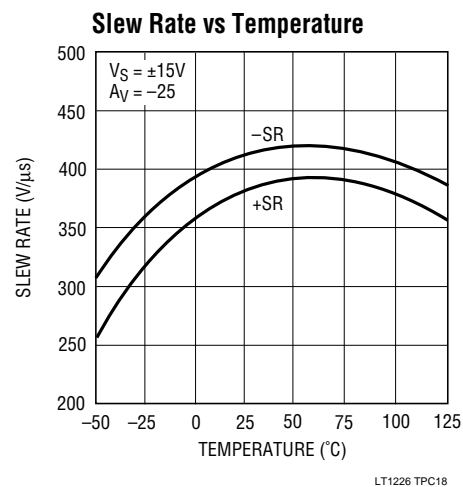
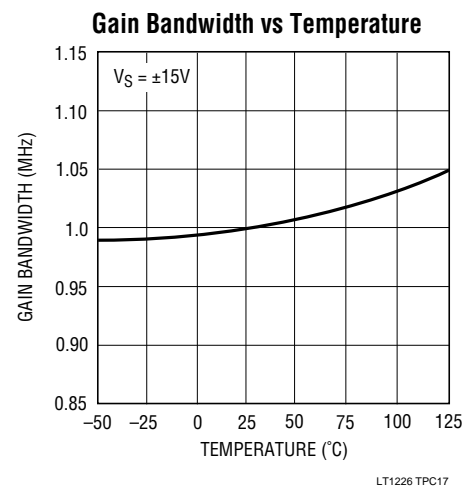
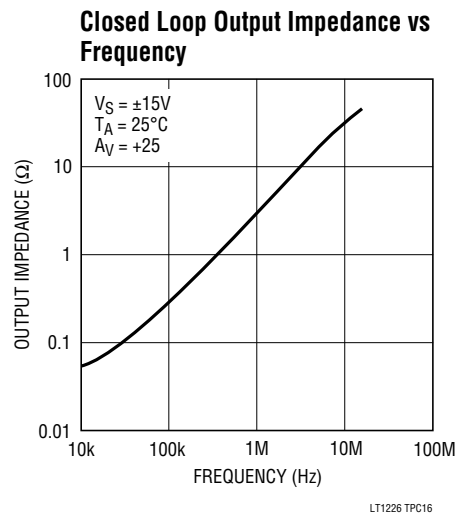
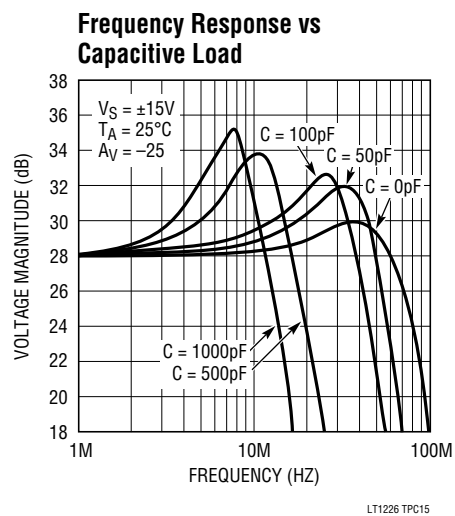
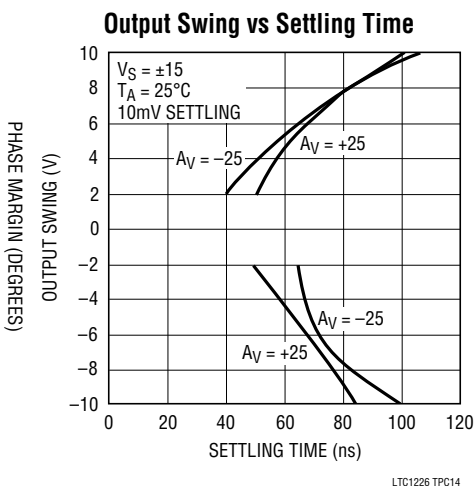
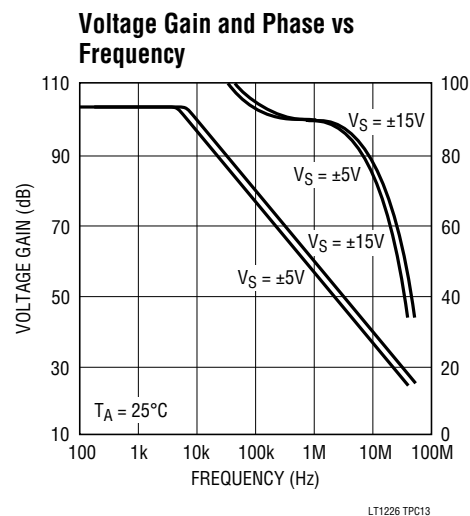
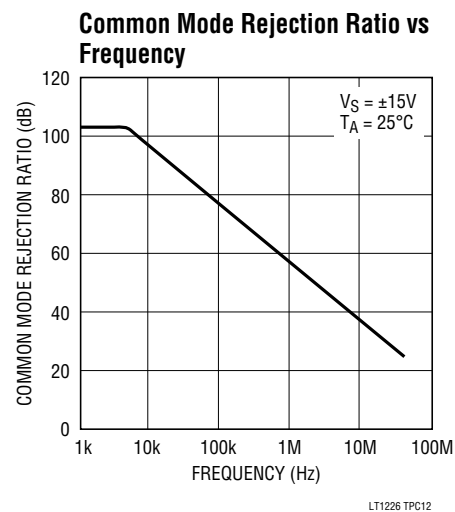
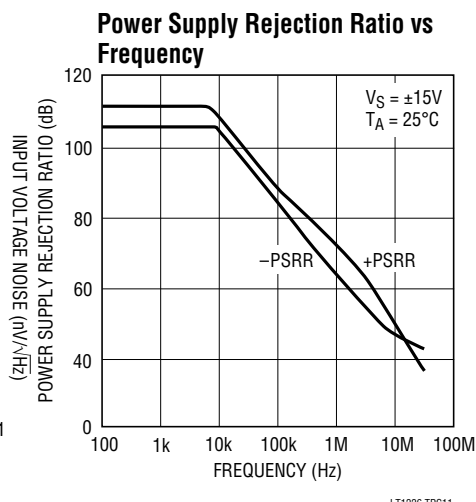
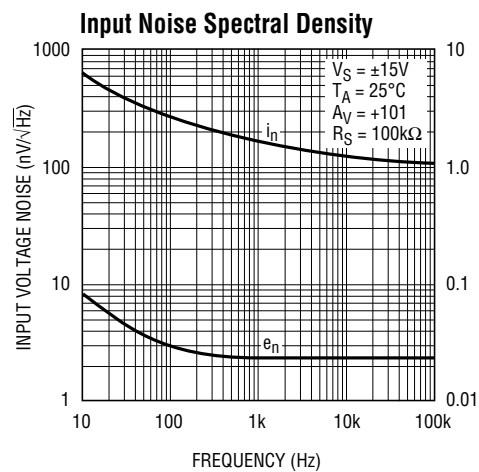

APPLICATIONS INFORMATION

The LT1226 may be inserted directly into HA2541, HA2544, AD847, EL2020 and LM6361 applications, provided that the amplifier configuration is a noise gain of 25 or greater, and the nulling circuitry is removed. The suggested nulling circuit for the LT1226 is shown below.

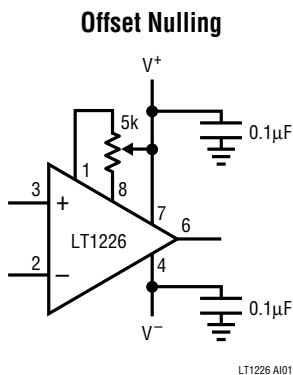

Layout and Passive Components

As with any high speed operational amplifier, care must be taken in board layout in order to obtain maximum performance. Key layout issues include: use of a ground plane, minimization of stray capacitance at the input pins, short lead lengths, RF-quality bypass capacitors located close to the device (typically 0.01µF to 0.1µF), and use of low ESR bypass capacitors for high drive current applications (typically 1µF to 10µF tantalum). Sockets should be avoided when maximum frequency performance is required, although low profile sockets can provide reasonable performance up to 50MHz. For more details see Design Note 50. Feedback resistors greater than 5kΩ are not recommended because a pole is formed with the input capacitance which can cause peaking. If feedback resistors greater than 5kΩ are used, a parallel capacitor of 5pF to 10pF should be used to cancel the input pole and optimize dynamic performance.

Transient Response

The LT1226 gain bandwidth is 1GHz when measured at 1MHz. The actual frequency response in a gain of +25 is considerably higher than 40MHz due to peaking caused by a second pole beyond the gain of 25 crossover point. This is reflected in the small signal transient response. Higher noise gain configurations exhibit less overshoot as seen in the inverting gain of 25 response.

Small Signal, $A_V = +25$

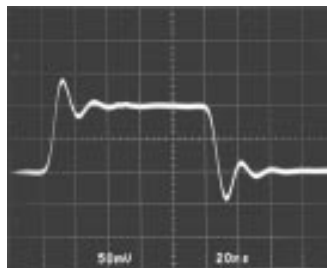

Small Signal, $A_V = -25$

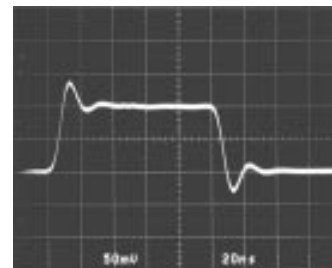

LT1226 A102

The large signal response in both inverting and noninverting gain shows symmetrical slewing characteristics. Normally the noninverting response has a much faster rising edge due to the rapid change in input common mode voltage which affects the tail current of the input differential pair. Slew enhancement circuitry has been added to the LT1226 so that the falling edge slew rate is enhanced which balances the noninverting slew rate response.

Large Signal, $A_V = +25$

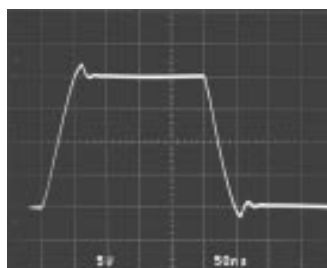

Large Signal, $A_V = -25$

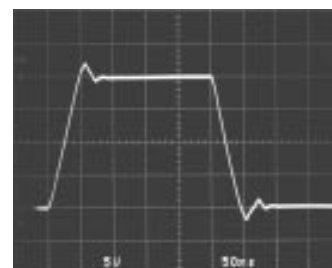

LT1226 A103

Input Considerations

Resistors in series with the inputs are recommended for the LT1226 in applications where the differential input voltage exceeds ±6V continuously or on a transient basis. An example would be in noninverting configurations with high input slew rates or when driving heavy capacitive loads. The use of balanced source resistance at each input is recommended for applications where DC accuracy must be maximized.

Capacitive Loading

The LT1226 is stable with all capacitive loads. This is accomplished by sensing the load induced output pole and adding compensation at the amplifier gain node. As the capacitive load increases, both the bandwidth and phase margin decrease so there will be peaking in the

APPLICATIONS INFORMATION

frequency domain and in the transient response. The photo of the small signal response with 1000pF load shows 55% peaking. The large signal response with a 10,000pF load shows the output slew rate being limited by the short circuit current.

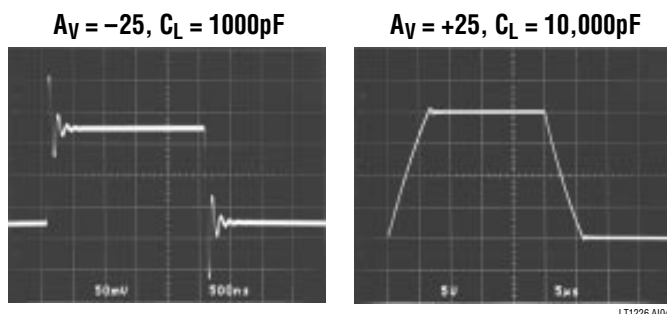

The LT1226 can drive coaxial cable directly, but for best pulse fidelity the cable should be doubly terminated with a resistor in series with the output.

Compensation

The LT1226 has a typical gain bandwidth product of 1GHz which allows it to have wide bandwidth in high gain

configurations (i.e., in a gain of 1000 it will have a bandwidth of about 1MHz). The amplifier is stable in a noise gain of 25 so the ratio of the output signal to the inverting input must be 1/25 or less. Straightforward gain configurations of +25 or -24 are stable, but there are a few configurations that allow the amplifier to be stable for lower signal gains (the noise gain, however, remains 25 or more). One example is the inverting amplifier shown in the typical applications sections below. The input signal has a gain of $-R_F/R_{IN}$ to the output, but it is easily seen that this configuration is equivalent to a gain of -24 as far as the amplifier is concerned. Lag compensation can also be used to give a low frequency gain less than 25 with a high frequency gain of 25 or greater. The example below has a DC gain of 6, but an AC gain of +31. The break frequency of the RC combination across the amplifier inputs should be at least a factor of 10 less than the gain bandwidth of the amplifier divided by the high frequency gain (in this case 1/10 of 1GHz/31 or 3MHz).

TYPICAL APPLICATIONS

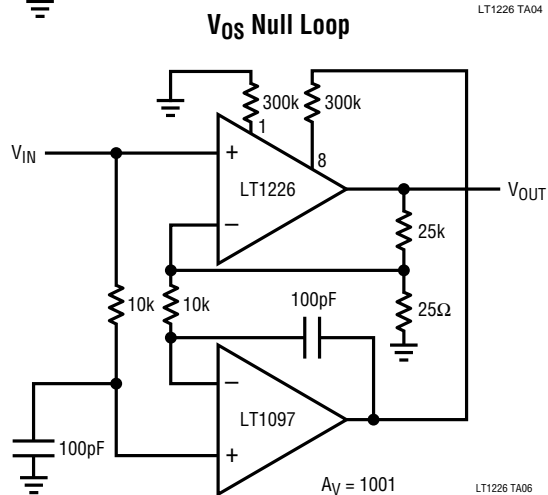
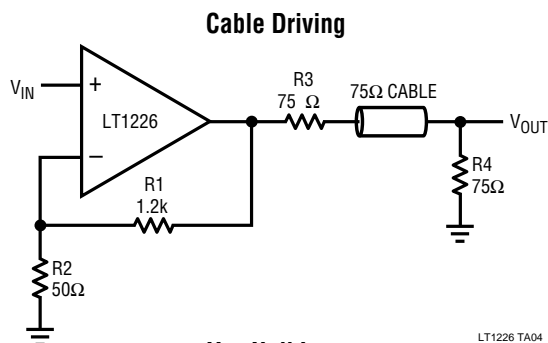
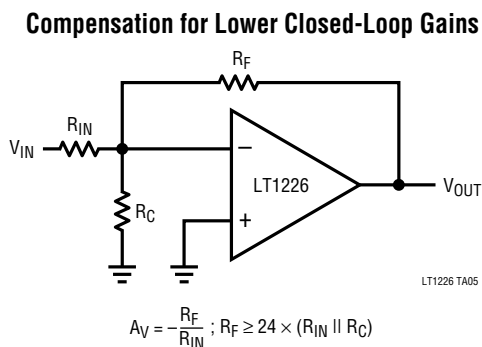
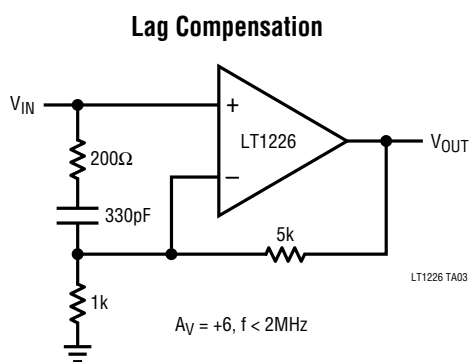

SIMPLIFIED SCHEMATIC

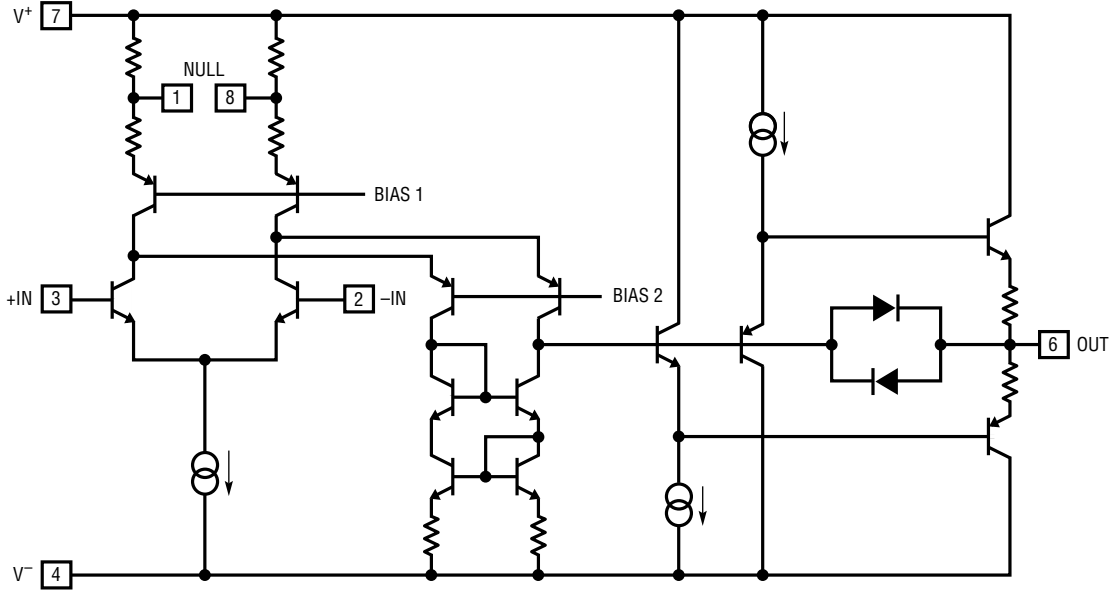

LT1226 SS

PACKAGE DESCRIPTION Dimensions in inches (millimeters) unless otherwise noted.

**N8 Package
8-Lead Plastic DIP**

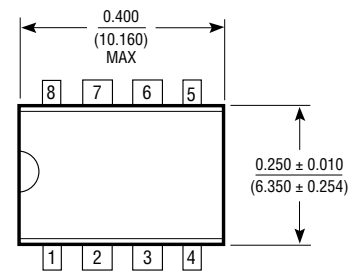
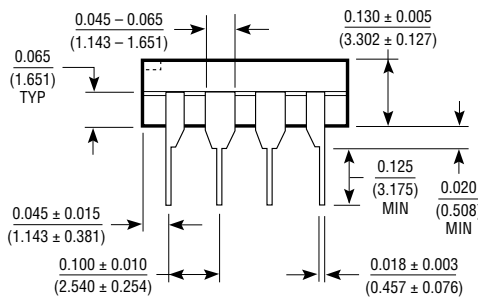
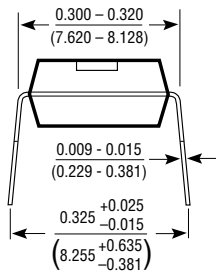

| | |
|--------------------|---------------|
| $T_{J\text{ MAX}}$ | θ_{JA} |
| 150°C | 130°C/W |

N8 1291

**S8 Package
8-Lead Plastic SOIC**

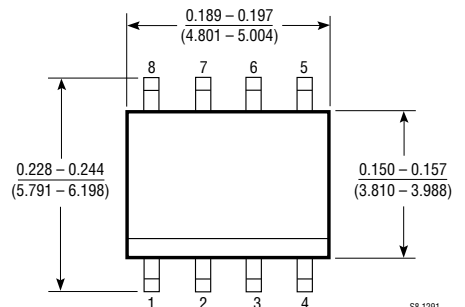
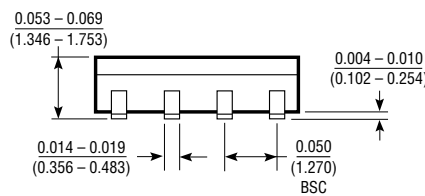
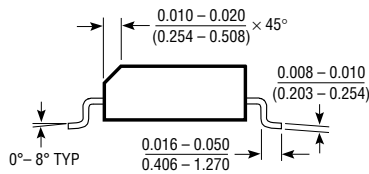

| | |
|--------------------|---------------|
| $T_{J\text{ MAX}}$ | θ_{JA} |
| 150°C | 220°C/W |

S8 1291