

## LMS202E 15KV ESD Rated, 5V Single Supply TIA/EIA-232 Dual Transceivers

Check for Samples: [LMS202E](#)

### FEATURES

- ESD Protection for RS-232 I/O Pins
- $\pm 15\text{kV}$ -IEC1000 4-2 (EN61000-4-2) Contact Discharge
- $\pm 8\text{kV}$ -IEC1000 4-2 (EN61000-4-2) Air-Gap Discharge
- $\pm 15\text{kV}$  Human Body Model
- Single +5V Power Supply
- 230 Kbps Data Rate
- On-Board DC-to-DC Converter
- $0.1\mu\text{F}$  Charge Pump Capacitors
- Drop-In Replacement to Maxim's MAX202E

### APPLICATIONS

- POS Equipment (Bar code reader)
- Hand-Held Equipment
- General Purpose RS-232 Communication

### DESCRIPTION

The LMS202E features two transmitters and two receivers for RS-232 communication. It has a DC-to-DC converter that permits the device to operate with only a single +5V power supply. The on-chip DC-to-DC converter which utilizes four external  $0.1\mu\text{F}$  capacitors to generate dual internal power supplies for RS-232 compatible output levels.

The device meet EIA/TIA-232E and CCITT V.28 specifications up to 230kbits/sec. The LMS202E is available in a 16 pin narrow and wide SOIC package.

The transmitter outputs and receiver inputs have  $\pm 15\text{kV}$  electrostatic discharge (ESD) protection. The LMS202E survives a  $\pm 15\text{kV}$  ESD event to the RS-232 input and output pins when subjected according to Human Body Model or IEC 1000-4-2 (EN61000-4-2), air-gap specification. It survives a  $\pm 8\text{kV}$  discharge when subjected to IEC 1000-4-2 (EN61000-4-2), contact specification. This device is designed for use in harsh environments where ESD is a concern.

### CONNECTION DIAGRAM AND TYPICAL CIRCUIT

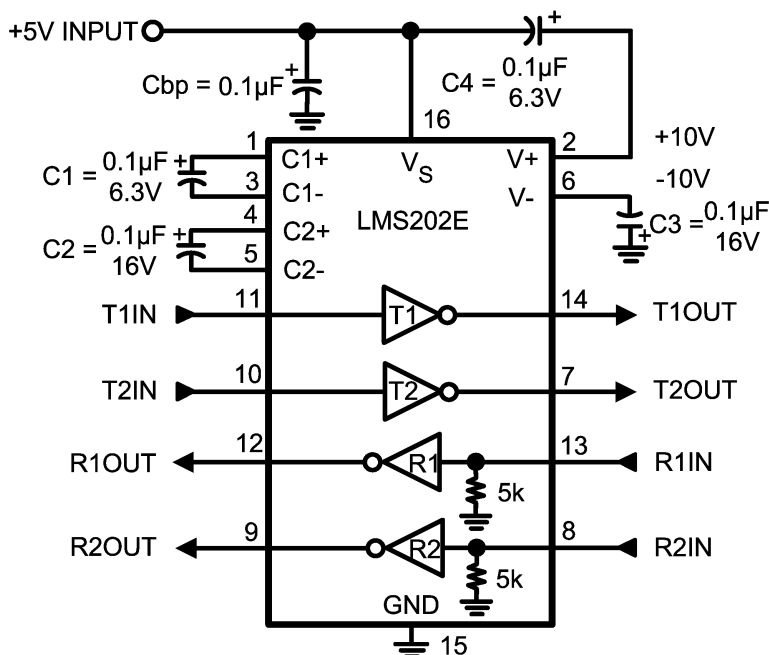

Please be aware that an important notice concerning availability, standard warranty, and use in critical applications of Texas Instruments semiconductor products and disclaimers thereto appears at the end of this data sheet.

All trademarks are the property of their respective owners.

### PIN DESCRIPTIONS

Pin Number	Pin Name	Pin Function
1, 3	C1+, C1-	External capacitor connection pins. Recommended external capacitor C1 = 0.1 $\mu$ F (6.3V)
2	V+	Positive supply for TIA/EIA-232E drivers. Recommended external capacitor C4 = 0.1 $\mu$ F (6.3V)
4, 5	C2+, C2-	External capacitor connection pins. Recommended external capacitor C2 = 0.1 $\mu$ F (16V)
6	V-	Negative supply for TIA/EIA-232E drivers. Recommended external capacitor C3 = 0.1 $\mu$ F (16V)
7, 14	T1out, T2out	Transmitter output pins conform to TIA/EIA-232E levels. The typical transmitter output swing is $\pm 8V$ when loaded 3k $\Omega$ load to ground. The open-circuit output voltage swings from (V+ - 0.6V) to V-
8, 13	R1in, R2in	Receiver inputs accept TIA/EIA-232
9, 12	R1out and R2out	Receiver output pins are TTL/CMOS compatible
10, 11	Tin1, Tin2	Transmitter input pins are TTL/CMOS compatible. Inputs of transmitter do not have pull-up resistors. Connect all unused transmitter inputs to ground
15	GND	Ground pin
16	V <sub>S</sub>	Power supply pin for the device, +5V ( $\pm 10\%$ )



These devices have limited built-in ESD protection. The leads should be shorted together or the device placed in conductive foam during storage or handling to prevent electrostatic damage to the MOS gates.

### ABSOLUTE MAXIMUM RATINGS <sup>(1)(2)</sup>

V <sub>S</sub>		-0.3V to 6V
V+		(V <sub>S</sub> - 0.3V) to + 14V
V-		+0.3V to -14V
Driver Input Voltage, T <sub>IN</sub>		-0.3V to (V+ + 0.3V)
Receiver Input Voltage, R <sub>IN</sub>		$\pm 30V$
Driver Output Voltage T <sub>O</sub>		(V- - 0.3V to (V+ + 0.3V)
Receiver Output Voltage R <sub>O</sub>		-0.3 to (V <sub>S</sub> + 0.3)
Short Circuit Duration, T <sub>O</sub>		Continuous
ESD Rating	IEC 1000-4-2 <sup>(3)</sup>	See <sup>(4)</sup>
	Air-Gap Discharge	15kV
	Contact Discharge	8kV
	Human Body Model <sup>(5)</sup>	See <sup>(4)</sup>
See <sup>(6)</sup>		2kV
ESD Rating (MM)		200V <sup>(7)(6)</sup>
Soldering Information	Infrared or Convection (20sec.)	235°C
Junction Temperature		150°C
Storage Temperature Range		-65°C to +150°C

- (1) Absolute Maximum Ratings indicate limits beyond which damage to the device may occur. Operating Ratings indicate conditions for which the device is intended to be functional, but specific performance is not ensured. For specifications and the test conditions, see the Electrical Characteristics.
- (2) If Military/Aerospace specified devices are required, please contact the Texas Instruments Sales Office/ Distributors for availability and specifications.
- (3) IEC 1000-4-2, 330 $\Omega$  in series with 150pF
- (4) ESD rating applies to pins 7, 8, 13 and 14
- (5) Human Body Model, 1.5k $\Omega$  in series with 100pF
- (6) ESD rating applies to pins 1, 2, 3, 4, 5, 6, 9, 10, 11, 12, 15 and 16
- (7) Machine model, 0 $\Omega$  in series with 200pF

## OPERATING RATINGS

Supply Voltage $V_S$		4.5V to 5.5V
Ambient Temperature Range, $T_A$	Commercial (C)	0°C to +70°C
	Industrial (I)	-40°C to +85°C
Package Thermal Resistance <sup>(1)</sup>		
SO		71°C/W
WSO		55°C/W

(1) The maximum power dissipation is a function of  $T_{J(MAX)}$ ,  $\theta_{JA}$ , and  $T_A$ . The maximum allowable power dissipation at any ambient temperature is  $P_D = (T_{J(MAX)} - T_A) / \theta_{JA}$ . All numbers apply for packages soldered directly onto a PC board.

## ELECTRICAL CHARACTERISTICS

Over recommended operating supply and temperature ranges unless otherwise specified

$C1 = C2 = C3 = C4 = C_{bp} = 0.1\mu F$

Symbol	Parameter	Conditions	Min <sup>(1)</sup>	Typ <sup>(2)</sup>	Max <sup>(1)</sup>	Units
<b>DC Characteristics</b>						
$I_S$	Supply Current	No Load, $T_A = 25^\circ C$		1	7	mA
<b>Logic</b>						
$I_{INPUT}$	Input Leakage Current	$T_{IN} = 0V$ to $V_S$			$\pm 10$	$\mu A$
$V_{THL}$	Input Logic Theshold Low	$T_{IN}$			0.8	V
$V_{THH}$	Input Logic Theshold High	$T_{IN}$	2.0			V
$V_{OL}$	TTL/CMOS Output Voltage Low	$R_{OUT}, I_{OUT} = 3.2mA$			0.4	V
$V_{OH}$	TTL/CMOS Output Voltage High	$R_{OUT}, I_{OUT} = -1.0mA$	3.5	$V_S - 0.1$		V
<b>RS-232 Receiver Inputs</b>						
$V_{RI}$	Receiver Input Voltage Range		-30		+30	V
$V_{RTHL}$	Receiver Input Theshold Low	$V_S = 5V, T_A = 25^\circ C$	0.8	1.4		V
$V_{RTHH}$	Receiver Input Theshold High	$V_S = 5V, T_A = 25^\circ C$		2	2.4	V
$V_{HYST}$	Receiver Input Hysteresis	$V_S = 5V$	0.2	0.6	1.0	V
$R_I$	Receiver Input Resistance	$V_S = 5V, T_A = 25^\circ C$	3	5	7	k $\Omega$
<b>RS-232 Transmitter Outputs</b>						
$V_O$	Transmitter Output Voltage Swing	All transmitters loaded with 3k $\Omega$ to GND	$\pm 5$	$\pm 8$		V
$R_O$	Output Resistance	$V_S = V_+ = V_- = 0V,$ $V_O = \pm 2V$	300			$\Omega$
$I_{OS}$	Output Short Circuit Current			$\pm 11$	$\pm 60$	mA
<b>Timing Characteristics</b>						
DR	Maximum Data Rate	$C_L = 50pF$ to 1000pF, $R_L = 3k\Omega$ to 7k $\Omega$	230			kbps
$T_{RPLH}$ $T_{RPHL}$	Receiver Propagation Delay	$C_L = 150pF$		0.08	1	$\mu s$
$T_{DPLH}$ $T_{DPHL}$	Transmitter Propagation Delay	$R_L = 3k\Omega, C_L = 2500pF$ All transmitters loaded		2.4		$\mu s$
$V_{SLEW}$	Transition Region Slew Rate	$T_A = 25^\circ C, V_S = 5V$ $C_L = 50pF$ to 1000pF, $R_L = 3k\Omega$ to 7k $\Omega$ Measured from +3V to -3V or vice versa	3	6	30	V/ $\mu s$
<b>ESD Performance: Transmitter Outputs and Receiver Inputs</b>						
ESD Rating		Human Body Model		$\pm 15$		kV
		IEC 1000-4-2, Contact		$\pm 8$		
		IEC 1000-4-2, Air-gap		$\pm 15$		

(1) All limits are specified by testing or statistical analysis

(2) Typical Values represent the most likely parametric norm.

### TYPICAL CHARACTERISTICS

Transmitter Output High Voltage vs. Load Capacitance

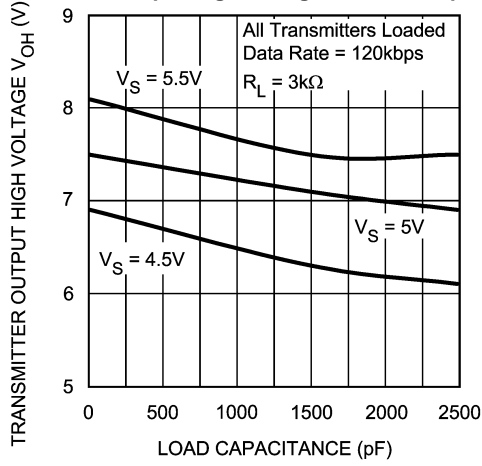

Transmitter Slew Rate vs. Load Capacitance

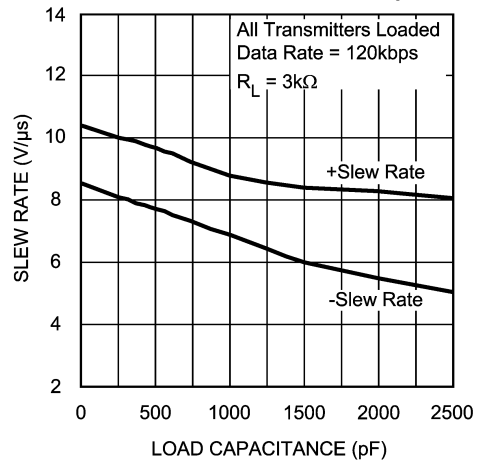

## APPLICATION INFORMATION

### CAPACITOR SELECTION

The recommended capacitors are 0.1 $\mu$ F. However, larger capacitors for the charge pump may be used to minimized ripples on V+ and V- pins.

### POWER SUPPLY DECOUPLING

In some applications that are sensitive to power supply noise from the charge pump, place a decoupling capacitor, Cbp, from V<sub>S</sub> to GND. Use at least a 0.1 $\mu$ F capacitor or the same size as the charge pump capacitors (C1 – C4).

### CHARGED PUMP

The dual internal charged-pump provides the  $\pm 10$ V to the transmitters. Using capacitor C1, the charge pump converts +5V to +10V then stores the +10V in capacitor C3. The charge pump uses capacitor C2 to invert the +10V to -10V. The -10V is then stored in capacitor C4.

### ELECTROSTATIC DISCHARGE PROTECTION

ESD protection has been placed at all pins to protect the device from ESD. All pins except for the transmitter output pins (pins 7 and 14) and receiver input pins (pins 8 and 13) have a ESD rating of 2kV Human Body Model (HBM) and 200V Machine Model (MM). The RS-232 bus pins (pins 7, 8, 13 and 14) have a more robust ESD protection. The RS-232 bus pins have a ESD rating of 15kV HBM and IEC 1000-4-2, air-gap. In addition the bus pins meet an ESD rating of 8kV with IEC 1000-4-2, contact. The ESD structures can withstand a high ESD event under the following conditions: powered-on, powered-off, and Input connected to high and low with outputs unloaded.

### HUMAN BODY MODEL

The Human Body Model is an ESD testing standard, defined in Mil-STD-883C method 3015.7. It simulates a human discharging an ESD charge to the IC device. The rise time is approximately 10 ns and decay time is approximately 150 ns. The waveform is obtained by discharging 2kV volts capacitor through a resistor, R2 = 1.5 k $\Omega$ . The peak current is approximately 1.33A.

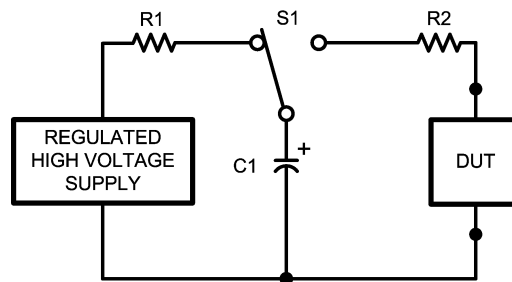

Figure 1. HBM ESD Test Model

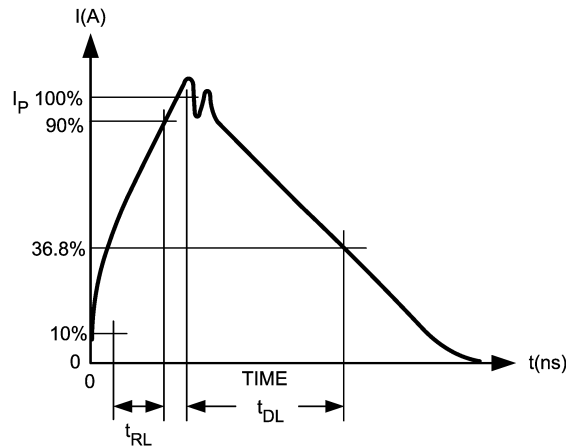

Figure 2. HBM Waveform

**MACHINE MODEL**

The Machine Model is the standard ESD test method in Japan and the automotive industry. It simulates a charge on large object discharging through the IC device. This takes place in automated test and handling systems. The equipment can accumulate static charge due to improper grounding, which is transmitted through the IC when it is picked and placed.

The waveform is obtained by discharging 400V volts capacitor to the device. Resistor, R2 = 0Ω.

The parasitic inductance, L, from the PCB affects the peak current and period of the waveform. For L = 0.5μH, the peak current is approximately 7A with a period of 60 ns. For L = 2.5μH, the peak current is reduced to 4A with a period of 140 ns.

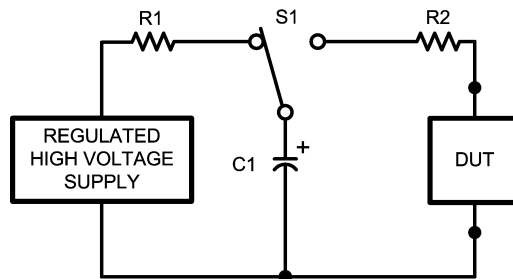

Figure 3. MM ESD Model

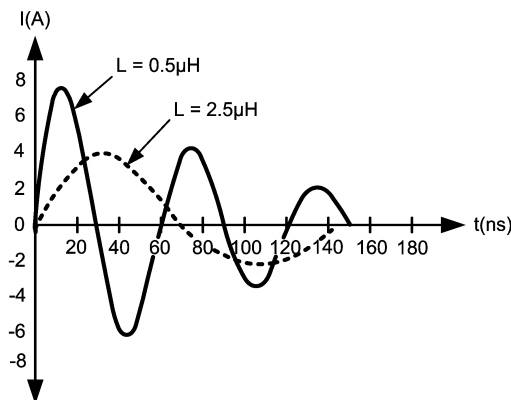

Figure 4. MM Waveform

### IEC 1000-4-2 (EN61000-4-2)

The European Union requires ESD immunity testing for all electronic products as a condition for EMC Mark before shipping to any member countries. This is not a IC requirement but an overall system requirement. IEC 1000-4-2 specifies ESD testing both by contact and air-gap discharge. ESD testing by contact are generally more repeatable than air-gap but is less realistic to actual ESD event. However, air-gap discharge is more realistic but ESD results may vary widely dependent on environmental conditions (temperature, humidity,...) The waveform is obtained by discharging 150pF capacitor through a resistor,  $R_2 = 330\Omega$ . A typical peak current may be high as 37A with 10kV.

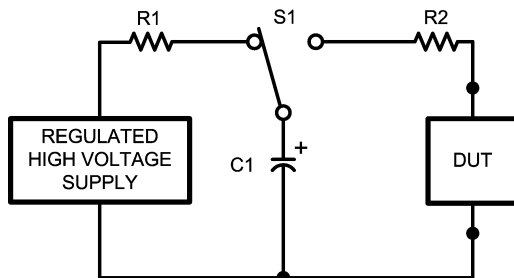

Figure 5. IEC ESD Model

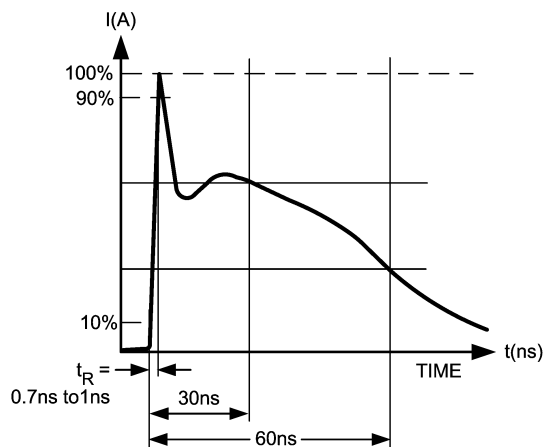

Figure 6. IEC Waveform

## REVISION HISTORY

Changes from Revision C (April 2013) to Revision D	Page
• Changed layout of National Data Sheet to TI format .....	<a href="#">7</a>



**PACKAGING INFORMATION**

Orderable Device	Status (1)	Package Type	Package Drawing	Pins	Package Qty	Eco Plan (2)	Lead/Ball Finish	MSL Peak Temp (3)	Op Temp (°C)	Top-Side Markings (4)	Samples
LMS202ECM	ACTIVE	SOIC	D	16	48	TBD	Call TI	Call TI	-40 to 85	LMS202ECM	<a href="#">Samples</a>
LMS202ECM/NOPB	ACTIVE	SOIC	D	16	48	Green (RoHS & no Sb/Br)	CU SN	Level-1-260C-UNLIM	-40 to 85	LMS202ECM	<a href="#">Samples</a>
LMS202ECMX	ACTIVE	SOIC	D	16	2500	TBD	Call TI	Call TI	-40 to 85	LMS202ECM	<a href="#">Samples</a>
LMS202ECMX/NOPB	ACTIVE	SOIC	D	16	2500	Green (RoHS & no Sb/Br)	CU SN	Level-1-260C-UNLIM	-40 to 85	LMS202ECM	<a href="#">Samples</a>
LMS202EIM	ACTIVE	SOIC	D	16	48	TBD	Call TI	Call TI	-40 to 85	LMS202EIM	<a href="#">Samples</a>
LMS202EIM/NOPB	ACTIVE	SOIC	D	16	48	Green (RoHS & no Sb/Br)	CU SN	Level-1-260C-UNLIM	-40 to 85	LMS202EIM	<a href="#">Samples</a>
LMS202EIMX	ACTIVE	SOIC	D	16	2500	TBD	Call TI	Call TI	-40 to 85	LMS202EIM	<a href="#">Samples</a>
LMS202EIMX/NOPB	ACTIVE	SOIC	D	16	2500	Green (RoHS & no Sb/Br)	CU SN	Level-1-260C-UNLIM	-40 to 85	LMS202EIM	<a href="#">Samples</a>

(1) The marketing status values are defined as follows:

**ACTIVE:** Product device recommended for new designs.

**LIFEBUY:** TI has announced that the device will be discontinued, and a lifetime-buy period is in effect.

**NRND:** Not recommended for new designs. Device is in production to support existing customers, but TI does not recommend using this part in a new design.

**PREVIEW:** Device has been announced but is not in production. Samples may or may not be available.

**OBSOLETE:** TI has discontinued the production of the device.

(2) Eco Plan - The planned eco-friendly classification: Pb-Free (RoHS), Pb-Free (RoHS Exempt), or Green (RoHS & no Sb/Br) - please check <http://www.ti.com/productcontent> for the latest availability information and additional product content details.

**TBD:** The Pb-Free/Green conversion plan has not been defined.

**Pb-Free (RoHS):** TI's terms "Lead-Free" or "Pb-Free" mean semiconductor products that are compatible with the current RoHS requirements for all 6 substances, including the requirement that lead not exceed 0.1% by weight in homogeneous materials. Where designed to be soldered at high temperatures, TI Pb-Free products are suitable for use in specified lead-free processes.

**Pb-Free (RoHS Exempt):** This component has a RoHS exemption for either 1) lead-based flip-chip solder bumps used between the die and package, or 2) lead-based die adhesive used between the die and leadframe. The component is otherwise considered Pb-Free (RoHS compatible) as defined above.

**Green (RoHS & no Sb/Br):** TI defines "Green" to mean Pb-Free (RoHS compatible), and free of Bromine (Br) and Antimony (Sb) based flame retardants (Br or Sb do not exceed 0.1% by weight in homogeneous material)

(3) MSL, Peak Temp. -- The Moisture Sensitivity Level rating according to the JEDEC industry standard classifications, and peak solder temperature.

(4) Multiple Top-Side Markings will be inside parentheses. Only one Top-Side Marking contained in parentheses and separated by a "~" will appear on a device. If a line is indented then it is a continuation of the previous line and the two combined represent the entire Top-Side Marking for that device.

**Important Information and Disclaimer:** The information provided on this page represents TI's knowledge and belief as of the date that it is provided. TI bases its knowledge and belief on information provided by third parties, and makes no representation or warranty as to the accuracy of such information. Efforts are underway to better integrate information from third parties. TI has taken and continues to take reasonable steps to provide representative and accurate information but may not have conducted destructive testing or chemical analysis on incoming materials and chemicals. TI and TI suppliers consider certain information to be proprietary, and thus CAS numbers and other limited information may not be available for release.

In no event shall TI's liability arising out of such information exceed the total purchase price of the TI part(s) at issue in this document sold by TI to Customer on an annual basis.

**TAPE AND REEL INFORMATION**

**QUADRANT ASSIGNMENTS FOR PIN 1 ORIENTATION IN TAPE**

\*All dimensions are nominal

Device	Package Type	Package Drawing	Pins	SPQ	Reel Diameter (mm)	Reel Width W1 (mm)	A0 (mm)	B0 (mm)	K0 (mm)	P1 (mm)	W (mm)	Pin1 Quadrant
LMS202ECMX	SOIC	D	16	2500	330.0	16.4	6.5	10.3	2.3	8.0	16.0	Q1
LMS202ECMX/NOPB	SOIC	D	16	2500	330.0	16.4	6.5	10.3	2.3	8.0	16.0	Q1
LMS202EIMX	SOIC	D	16	2500	330.0	16.4	6.5	10.3	2.3	8.0	16.0	Q1
LMS202EIMX/NOPB	SOIC	D	16	2500	330.0	16.4	6.5	10.3	2.3	8.0	16.0	Q1

## TAPE AND REEL BOX DIMENSIONS



\*All dimensions are nominal

Device	Package Type	Package Drawing	Pins	SPQ	Length (mm)	Width (mm)	Height (mm)
LMS202ECMX	SOIC	D	16	2500	367.0	367.0	35.0
LMS202ECMX/NOPB	SOIC	D	16	2500	367.0	367.0	35.0
LMS202EIMX	SOIC	D	16	2500	367.0	367.0	35.0
LMS202EIMX/NOPB	SOIC	D	16	2500	367.0	367.0	35.0

D (R-PDSO-G16)

PLASTIC SMALL OUTLINE



- NOTES:
- A. All linear dimensions are in inches (millimeters).
  - B. This drawing is subject to change without notice.
  - C. Body length does not include mold flash, protrusions, or gate burrs. Mold flash, protrusions, or gate burrs shall not exceed 0.006 (0,15) each side.
  - D. Body width does not include interlead flash. Interlead flash shall not exceed 0.017 (0,43) each side.
  - E. Reference JEDEC MS-012 variation AC.

## IMPORTANT NOTICE

Texas Instruments Incorporated and its subsidiaries (TI) reserve the right to make corrections, enhancements, improvements and other changes to its semiconductor products and services per JESD46, latest issue, and to discontinue any product or service per JESD48, latest issue. Buyers should obtain the latest relevant information before placing orders and should verify that such information is current and complete. All semiconductor products (also referred to herein as "components") are sold subject to TI's terms and conditions of sale supplied at the time of order acknowledgment.

TI warrants performance of its components to the specifications applicable at the time of sale, in accordance with the warranty in TI's terms and conditions of sale of semiconductor products. Testing and other quality control techniques are used to the extent TI deems necessary to support this warranty. Except where mandated by applicable law, testing of all parameters of each component is not necessarily performed.

TI assumes no liability for applications assistance or the design of Buyers' products. Buyers are responsible for their products and applications using TI components. To minimize the risks associated with Buyers' products and applications, Buyers should provide adequate design and operating safeguards.

TI does not warrant or represent that any license, either express or implied, is granted under any patent right, copyright, mask work right, or other intellectual property right relating to any combination, machine, or process in which TI components or services are used. Information published by TI regarding third-party products or services does not constitute a license to use such products or services or a warranty or endorsement thereof. Use of such information may require a license from a third party under the patents or other intellectual property of the third party, or a license from TI under the patents or other intellectual property of TI.

Reproduction of significant portions of TI information in TI data books or data sheets is permissible only if reproduction is without alteration and is accompanied by all associated warranties, conditions, limitations, and notices. TI is not responsible or liable for such altered documentation. Information of third parties may be subject to additional restrictions.

Resale of TI components or services with statements different from or beyond the parameters stated by TI for that component or service voids all express and any implied warranties for the associated TI component or service and is an unfair and deceptive business practice. TI is not responsible or liable for any such statements.

Buyer acknowledges and agrees that it is solely responsible for compliance with all legal, regulatory and safety-related requirements concerning its products, and any use of TI components in its applications, notwithstanding any applications-related information or support that may be provided by TI. Buyer represents and agrees that it has all the necessary expertise to create and implement safeguards which anticipate dangerous consequences of failures, monitor failures and their consequences, lessen the likelihood of failures that might cause harm and take appropriate remedial actions. Buyer will fully indemnify TI and its representatives against any damages arising out of the use of any TI components in safety-critical applications.

In some cases, TI components may be promoted specifically to facilitate safety-related applications. With such components, TI's goal is to help enable customers to design and create their own end-product solutions that meet applicable functional safety standards and requirements. Nonetheless, such components are subject to these terms.

No TI components are authorized for use in FDA Class III (or similar life-critical medical equipment) unless authorized officers of the parties have executed a special agreement specifically governing such use.

Only those TI components which TI has specifically designated as military grade or "enhanced plastic" are designed and intended for use in military/aerospace applications or environments. Buyer acknowledges and agrees that any military or aerospace use of TI components which have **not** been so designated is solely at the Buyer's risk, and that Buyer is solely responsible for compliance with all legal and regulatory requirements in connection with such use.

TI has specifically designated certain components as meeting ISO/TS16949 requirements, mainly for automotive use. In any case of use of non-designated products, TI will not be responsible for any failure to meet ISO/TS16949.

### Products

Audio	<a href="http://www.ti.com/audio">www.ti.com/audio</a>
Amplifiers	<a href="http://amplifier.ti.com">amplifier.ti.com</a>
Data Converters	<a href="http://dataconverter.ti.com">dataconverter.ti.com</a>
DLP® Products	<a href="http://www.dlp.com">www.dlp.com</a>
DSP	<a href="http://dsp.ti.com">dsp.ti.com</a>
Clocks and Timers	<a href="http://www.ti.com/clocks">www.ti.com/clocks</a>
Interface	<a href="http://interface.ti.com">interface.ti.com</a>
Logic	<a href="http://logic.ti.com">logic.ti.com</a>
Power Mgmt	<a href="http://power.ti.com">power.ti.com</a>
Microcontrollers	<a href="http://microcontroller.ti.com">microcontroller.ti.com</a>
RFID	<a href="http://www.ti-rfid.com">www.ti-rfid.com</a>
OMAP Applications Processors	<a href="http://www.ti.com/omap">www.ti.com/omap</a>
Wireless Connectivity	<a href="http://www.ti.com/wirelessconnectivity">www.ti.com/wirelessconnectivity</a>

### Applications

Automotive and Transportation	<a href="http://www.ti.com/automotive">www.ti.com/automotive</a>
Communications and Telecom	<a href="http://www.ti.com/communications">www.ti.com/communications</a>
Computers and Peripherals	<a href="http://www.ti.com/computers">www.ti.com/computers</a>
Consumer Electronics	<a href="http://www.ti.com/consumer-apps">www.ti.com/consumer-apps</a>
Energy and Lighting	<a href="http://www.ti.com/energy">www.ti.com/energy</a>
Industrial	<a href="http://www.ti.com/industrial">www.ti.com/industrial</a>
Medical	<a href="http://www.ti.com/medical">www.ti.com/medical</a>
Security	<a href="http://www.ti.com/security">www.ti.com/security</a>
Space, Avionics and Defense	<a href="http://www.ti.com/space-avionics-defense">www.ti.com/space-avionics-defense</a>
Video and Imaging	<a href="http://www.ti.com/video">www.ti.com/video</a>

### TI E2E Community

[e2e.ti.com](http://e2e.ti.com)