

LMH6642/LMH6643/LMH6644

Low Power, 130MHz, 75mA Rail-to-Rail Output Amplifiers

General Description

The LMH664X family true single supply voltage feedback amplifiers offer high speed (130MHz), low distortion (-62dBc), and exceptionally high output current (approximately 75mA) at low cost and with reduced power consumption when compared against existing devices with similar performance.

Input common mode voltage range extends to 0.5V below V^- and 1V from V^+ . Output voltage range extends to within 40mV of either supply rail, allowing wide dynamic range especially desirable in low voltage applications. The output stage is capable of approximately 75mA in order to drive heavy loads. Fast output Slew Rate ($130\text{V}/\mu\text{s}$) ensures large peak-to-peak output swings can be maintained even at higher speeds, resulting in exceptional full power bandwidth of 40MHz with a 3V supply. These characteristics, along with low cost, are ideal features for a multitude of industrial and commercial applications.

Careful attention has been paid to ensure device stability under all operating voltages and modes. The result is a very well behaved frequency response characteristic (0.1dB gain flatness up the 12MHz under 150Ω load and $A_V = +2$) with minimal peaking (typically 2dB maximum) for any gain setting and under both heavy and light loads. This along with fast settling time (68ns) and low distortion allows the device to operate well in ADC buffer, and high frequency filter applications as well as other applications.

This device family offers professional quality video performance with low DG (0.01%) and DP (0.01°) characteristics. Differential Gain and Differential Phase characteristics are also well maintained under heavy loads (150Ω) and throughout the output voltage range. The LMH664X family is offered in single (LMH6642), dual (LMH6643), and quad (LMH6644) options. See ordering information for packages offered.

Features

($V_S = \pm 5\text{V}$, $T_A = 25^\circ\text{C}$, $R_L = 2\text{k}\Omega$, $A_V = +1$. Typical values unless specified).

- -3dB BW ($A_V = +1$) 130MHz
- Supply voltage range 2.7V to 12.8V
- Slew rate (*Note 8*), ($A_V = -1$) $130\text{V}/\mu\text{s}$
- Supply current (no load) 2.7mA/amp
- Output short circuit current $+115\text{mA}/-145\text{mA}$
- Linear output current $\pm 75\text{mA}$
- Input common mode volt. 0.5V beyond V^- , 1V from V^+
- Output voltage swing 40mV from rails
- Input voltage noise (100kHz) $17\text{nV}/\sqrt{\text{Hz}}$
- Input current noise (100kHz) $0.9\text{pA}/\sqrt{\text{Hz}}$
- THD (5MHz, $R_L = 2\text{k}\Omega$, $V_O = 2V_{PP}$, $A_V = +2$) -62dBc
- Settling time 68ns
- Fully characterized for 3V, 5V, and $\pm 5\text{V}$
- Overdrive recovery 100ns
- Output short circuit protected (*Note 11*)
- No output phase reversal with CMVR exceeded

Applications

- Active filters
- CD/DVD ROM
- ADC buffer amp
- Portable video
- Current sense buffer

Closed Loop Gain vs. Frequency for Various Gain

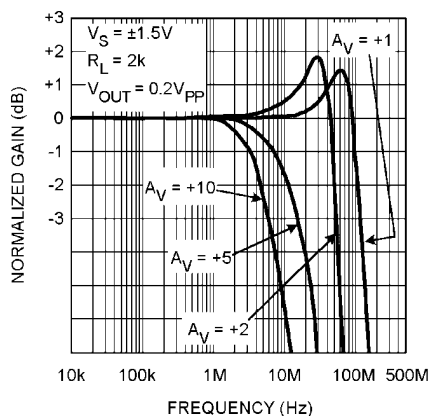

20018535

Large Signal Frequency Response

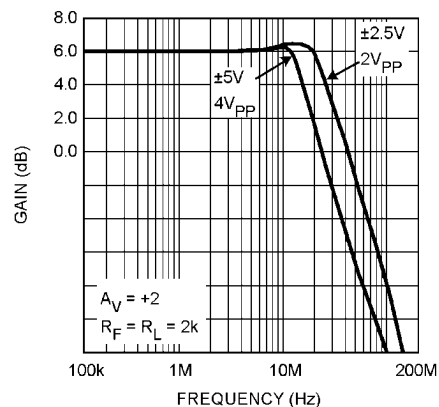

20018547

Absolute Maximum Ratings (Note 1)

If Military/Aerospace specified devices are required, please contact the Texas Instruments Sales Office/ Distributors for availability and specifications.

ESD Tolerance	2KV (Note 2)
	200V (Note 9)
	1000V (Note 13)
V_{IN} Differential	$\pm 2.5V$
Output Short Circuit Duration	(Note 3), (Note 11)
Supply Voltage ($V^+ - V^-$)	13.5V
Voltage at Input/Output pins	$V^+ + 0.8V$, $V^- - 0.8V$
Input Current	$\pm 10mA$
Storage Temperature Range	$-65^\circ C$ to $+150^\circ C$
Junction Temperature (Note 4)	$+150^\circ C$

Soldering Information

Infrared or Convection Reflow(20 sec)	235°C
Wave Soldering Lead Temp.(10 sec)	260°C

Operating Ratings (Note 1)

Supply Voltage ($V^+ - V^-$)	2.7V to 12.8V
Junction Temperature Range (Note 4)	$-40^\circ C$ to $+85^\circ C$
Package Thermal Resistance (Note 4) (θ_{JA})	
5-Pin SOT-23	265°C/W
8-Pin SOIC	190°C/W
8-Pin MSOP	235°C/W
14-Pin SOIC	145°C/W
14-Pin TSSOP	155°C/W

3V Electrical Characteristics

Unless otherwise specified, all limits guaranteed for at $T_J = 25^\circ C$, $V^+ = 3V$, $V^- = 0V$, $V_{CM} = V_O = V^+/2$, V_{ID} (input differential voltage) as noted (where applicable) and $R_L = 2k\Omega$ to $V^+/2$. **Boldface** limits apply at the temperature extremes.

Symbol	Parameter	Conditions	Min (Note 6)	Typ (Note 5)	Max (Note 6)	Units
BW	-3dB BW	$A_V = +1$, $V_{OUT} = 200mV_{PP}$	80	115		MHz
		$A_V = +2, -1$, $V_{OUT} = 200mV_{PP}$		46		
$BW_{0.1dB}$	0.1dB Gain Flatness	$A_V = +2$, $R_L = 150\Omega$ to $V^+/2$, $R_L = 402\Omega$, $V_{OUT} = 200mV_{PP}$		19		MHz
PBW	Full Power Bandwidth	$A_V = +1$, $-1dB$, $V_{OUT} = 1V_{PP}$		40		MHz
e_n	Input-Referred Voltage Noise	$f = 100kHz$		17		nV/\sqrt{Hz}
		$f = 1kHz$		48		
i_n	Input-Referred Current Noise	$f = 100kHz$		0.90		pA/\sqrt{Hz}
		$f = 1kHz$		3.3		
THD	Total Harmonic Distortion	$f = 5MHz$, $V_O = 2V_{PP}$, $A_V = -1$, $R_L = 100\Omega$ to $V^+/2$		-48		dBc
DG	Differential Gain	$V_{CM} = 1V$, NTSC, $A_V = +2$ $R_L = 150\Omega$ to $V^+/2$		0.17		%
		$R_L = 1k\Omega$ to $V^+/2$		0.03		
DP	Differential Phase	$V_{CM} = 1V$, NTSC, $A_V = +2$ $R_L = 150\Omega$ to $V^+/2$		0.05		deg
		$R_L = 1k\Omega$ to $V^+/2$		0.03		
CT Rej.	Cross-Talk Rejection	$f = 5MHz$, Receiver: $R_f = R_g = 510\Omega$, $A_V = +2$		47		dB
T_S	Settling Time	$V_O = 2V_{PP}$, $\pm 0.1\%$, 8pF Load, $V_S = 5V$		68		ns
SR	Slew Rate (Note 8)	$A_V = -1$, $V_I = 2V_{PP}$	90	120		V/ μs
V_{OS}	Input Offset Voltage	For LMH6642 and LMH6644		± 1	± 5 ± 7	mV
		For LMH6643		± 1	± 3.4 ± 7	
TC V_{OS}	Input Offset Average Drift	(Note 12)		± 5		$\mu V/^\circ C$
I_B	Input Bias Current	(Note 7)		-1.50	-2.60 -3.25	μA
I_{OS}	Input Offset Current			20	800 1000	nA
R_{IN}	Common Mode Input Resistance			3		M Ω

Symbol	Parameter	Conditions	Min (Note 6)	Typ (Note 5)	Max (Note 6)	Units
C_{IN}	Common Mode Input Capacitance			2		pF
CMVR	Input Common-Mode Voltage Range	CMRR \geq 50dB		-0.5	-0.2 -0.1	V
			1.8 1.6	2.0		
CMRR	Common Mode Rejection Ratio	V_{CM} Stepped from 0V to 1.5V	72	95		dB
A_{VOL}	Large Signal Voltage Gain	$V_O = 0.5V$ to 2.5V $R_L = 2k\Omega$ to $V+/2$	80 75	96		dB
		$V_O = 0.5V$ to 2.5V $R_L = 150\Omega$ to $V+/2$	74 70	82		
V_O	Output Swing High	$R_L = 2k\Omega$ to $V+/2$, $V_{ID} = 200mV$	2.90	2.98		V
		$R_L = 150\Omega$ to $V+/2$, $V_{ID} = 200mV$	2.80	2.93		
	Output Swing Low	$R_L = 2k\Omega$ to $V+/2$, $V_{ID} = -200mV$		25	75	mV
		$R_L = 150\Omega$ to $V+/2$, $V_{ID} = -200mV$		75	150	
I_{SC}	Output Short Circuit Current	Sourcing to $V+/2$ $V_{ID} = 200mV$ (Note 10)	50 35	95		mA
		Sinking to $V+/2$ $V_{ID} = -200mV$ (Note 10)	55 40	110		
I_{OUT}	Output Current	$V_{OUT} = 0.5V$ from either supply		± 65		mA
+PSRR	Positive Power Supply Rejection Ratio	$V+ = 3.0V$ to 3.5V, $V_{CM} = 1.5V$	75	85		dB
I_S	Supply Current (per channel)	No Load		2.70	4.00 4.50	mA

5V Electrical Characteristics

Unless otherwise specified, all limits guaranteed for at $T_J = 25^\circ C$, $V+ = 5V$, $V- = 0V$, $V_{CM} = V_O = V+/2$, V_{ID} (input differential voltage) as noted (where applicable) and $R_L = 2k\Omega$ to $V+/2$. **Boldface** limits apply at the temperature extremes.

Symbol	Parameter	Conditions	Min (Note 6)	Typ (Note 5)	Max (Note 6)	Units
BW	-3dB BW	$A_V = +1$, $V_{OUT} = 200mV_{PP}$	90	120		MHz
		$A_V = +2$, -1, $V_{OUT} = 200mV_{PP}$		46		
$BW_{0.1dB}$	0.1dB Gain Flatness	$A_V = +2$, $R_L = 150\Omega$ to $V+/2$, $R_f = 402\Omega$, $V_{OUT} = 200mV_{PP}$		15		MHz
PBW	Full Power Bandwidth	$A_V = +1$, -1dB, $V_{OUT} = 2V_{PP}$		22		MHz
e_n	Input-Referred Voltage Noise	$f = 100kHz$		17		nV/\sqrt{Hz}
		$f = 1kHz$		48		
i_n	Input-Referred Current Noise	$f = 100kHz$		0.90		pA/\sqrt{Hz}
		$f = 1kHz$		3.3		
THD	Total Harmonic Distortion	$f = 5MHz$, $V_O = 2V_{PP}$, $A_V = +2$		-60		dBc
DG	Differential Gain	NTSC, $A_V = +2$ $R_L = 150\Omega$ to $V+/2$		0.16		%
		$R_L = 1k\Omega$ to $V+/2$		0.05		
DP	Differential Phase	NTSC, $A_V = +2$ $R_L = 150\Omega$ to $V+/2$		0.05		deg
		$R_L = 1k\Omega$ to $V+/2$		0.01		
CT Rej.	Cross-Talk Rejection	$f = 5MHz$, Receiver: $R_f = R_g = 510\Omega$, $A_V = +2$		47		dB

Symbol	Parameter	Conditions	Min (Note 6)	Typ (Note 5)	Max (Note 6)	Units
T_S	Settling Time	$V_O = 2V_{PP}, \pm 0.1\%, 8pF$ Load		68		ns
SR	Slew Rate (Note 8)	$A_V = -1, V_I = 2V_{PP}$	95	125		V/ μ s
V_{OS}	Input Offset Voltage	For LMH6642 and LMH6644		± 1	± 5 ± 7	mV
		For LMH6643		± 1	± 3.4 ± 7	
TC V_{OS}	Input Offset Average Drift	(Note 12)		± 5		μ V/ $^{\circ}$ C
I_B	Input Bias Current	(Note 7)		-1.70	-2.60 -3.25	μ A
I_{OS}	Input Offset Current			20	800 1000	nA
R_{IN}	Common Mode Input Resistance			3		M Ω
C_{IN}	Common Mode Input Capacitance			2		pF
CMVR	Input Common-Mode Voltage Range	CMRR ≥ 50 dB		-0.5	-0.2 -0.1	V
			3.8 3.6	4.0		
CMRR	Common Mode Rejection Ratio	V_{CM} Stepped from 0V to 3.5V	72	95		dB
A_{VOL}	Large Signal Voltage Gain	$V_O = 0.5V$ to 4.50V $R_L = 2k\Omega$ to $V+/2$	86 82	98		dB
		$V_O = 0.5V$ to 4.25V $R_L = 150\Omega$ to $V+/2$	76 72	82		
V_O	Output Swing High	$R_L = 2k\Omega$ to $V+/2, V_{ID} = 200mV$	4.90	4.98		V
		$R_L = 150\Omega$ to $V+/2, V_{ID} = 200mV$	4.65	4.90		
	Output Swing Low	$R_L = 2k\Omega$ to $V+/2, V_{ID} = -200mV$		25	100	mV
		$R_L = 150\Omega$ to $V+/2, V_{ID} = -200mV$		100	150	
I_{SC}	Output Short Circuit Current	Sourcing to $V+/2$ $V_{ID} = 200mV$ (Note 10)	55 40	115		mA
		Sinking to $V+/2$ $V_{ID} = -200mV$ (Note 10)	70 55	140		
I_{OUT}	Output Current	$V_O = 0.5V$ from either supply		± 70		mA
+PSRR	Positive Power Supply Rejection Ratio	$V^+ = 4.0V$ to 6V	79	90		dB
I_S	Supply Current (per channel)	No Load		2.70	4.25 5.00	mA

$\pm 5V$ Electrical Characteristics

Unless otherwise specified, all limits guaranteed for at $T_J = 25^{\circ}C, V^+ = 5V, V^- = -5V, V_{CM} = V_O = 0V, V_{ID}$ (input differential voltage) as noted (where applicable) and $R_L = 2k\Omega$ to ground. **Boldface** limits apply at the temperature extremes.

Symbol	Parameter	Conditions	Min (Note 6)	Typ (Note 5)	Max (Note 6)	Units
BW	-3dB BW	$A_V = +1, V_{OUT} = 200mV_{PP}$	95	130		MHz
		$A_V = +2, -1, V_{OUT} = 200mV_{PP}$		46		
$BW_{0.1dB}$	0.1dB Gain Flatness	$A_V = +2, R_L = 150\Omega$ to $V+/2,$ $R_f = 806\Omega, V_{OUT} = 200mV_{PP}$		12		MHz
PBW	Full Power Bandwidth	$A_V = +1, -1dB, V_{OUT} = 2V_{PP}$		24		MHz
e_n	Input-Referred Voltage Noise	$f = 100kHz$		17		nV/ \sqrt{Hz}
		$f = 1kHz$		48		

Symbol	Parameter	Conditions	Min (Note 6)	Typ (Note 5)	Max (Note 6)	Units
i_n	Input-Referred Current Noise	$f = 100\text{kHz}$		0.90		$\text{pA}/\sqrt{\text{Hz}}$
		$f = 1\text{kHz}$		3.3		
THD	Total Harmonic Distortion	$f = 5\text{MHz}$, $V_O = 2V_{PP}$, $A_V = +2$		-62		dBc
DG	Differential Gain	NTSC, $A_V = +2$ $R_L = 150\Omega$ to $V+/2$		0.15		%
		$R_L = 1\text{k}\Omega$ to $V+/2$		0.01		
DP	Differential Phase	NTSC, $A_V = +2$ $R_L = 150\Omega$ to $V+/2$		0.04		deg
		$R_L = 1\text{k}\Omega$ to $V+/2$		0.01		
CT Rej.	Cross-Talk Rejection	$f = 5\text{MHz}$, Receiver: $R_f = R_g = 510\Omega$, $A_V = +2$		47		dB
T_S	Settling Time	$V_O = 2V_{PP}$, $\pm 0.1\%$, 8pF Load, $V_S = 5\text{V}$		68		ns
SR	Slew Rate (Note 8)	$A_V = -1$, $V_I = 2V_{PP}$	100	135		V/ μs
V_{OS}	Input Offset Voltage	For LMH6642 and LMH6644		± 1	± 5 ± 7	mV
		For LMH6643		± 1	± 3.4 ± 7	
TC V_{OS}	Input Offset Average Drift	(Note 12)		± 5		$\mu\text{V}/^\circ\text{C}$
I_B	Input Bias Current	(Note 7)		-1.60	-2.60 -3.25	μA
I_{OS}	Input Offset Current			20	800 1000	nA
R_{IN}	Common Mode Input Resistance			3		M Ω
C_{IN}	Common Mode Input Capacitance			2		pF
CMVR	Input Common-Mode Voltage Range	CMRR $\geq 50\text{dB}$		-5.5	-5.2 -5.1	V
			3.8 3.6	4.0		
CMRR	Common Mode Rejection Ratio	V_{CM} Stepped from -5V to 3.5V	74	95		dB
A_{VOL}	Large Signal Voltage Gain	$V_O = -4.5\text{V}$ to 4.5V , $R_L = 2\text{k}\Omega$	88 84	96		dB
		$V_O = -4.0\text{V}$ to 4.0V , $R_L = 150\Omega$	78 74	82		
V_O	Output Swing High	$R_L = 2\text{k}\Omega$, $V_{ID} = 200\text{mV}$	4.90	4.96		V
		$R_L = 150\Omega$, $V_{ID} = 200\text{mV}$	4.65	4.80		
	Output Swing Low	$R_L = 2\text{k}\Omega$, $V_{ID} = -200\text{mV}$		-4.96	-4.90	V
		$R_L = 150\Omega$, $V_{ID} = -200\text{mV}$		-4.80	-4.65	
I_{SC}	Output Short Circuit Current	Sourcing to Ground $V_{ID} = 200\text{mV}$ (Note 10)	60 35	115		mA
		Sinking to Ground $V_{ID} = -200\text{mV}$ (Note 10)	85 65	145		
I_{OUT}	Output Current	$V_O = 0.5\text{V}$ from either supply	± 75			mA
PSRR	Power Supply Rejection Ratio	$(V^+, V^-) = (4.5\text{V}, -4.5\text{V})$ to $(5.5\text{V}, -5.5\text{V})$	78	90		dB
I_S	Supply Current (per channel)	No Load		2.70	4.50 5.50	mA

Note 1: Absolute Maximum Ratings indicate limits beyond which damage to the device may occur. Operating Ratings indicate conditions for which the device is intended to be functional, but specific performance is not guaranteed. For guaranteed specifications and the test conditions, see the Electrical Characteristics.

Note 2: Human body model, 1.5kΩ in series with 100pF.

Note 3: Applies to both single-supply and split-supply operation. Continuous short circuit operation at elevated ambient temperature can result in exceeding the maximum allowed junction temperature of 150°C.

Note 4: The maximum power dissipation is a function of $T_{J(MAX)}$, θ_{JA} , and T_A . The maximum allowable power dissipation at any ambient temperature is $P_D = (T_{J(MAX)} - T_A) / \theta_{JA}$. All numbers apply for packages soldered directly onto a PC board.

Note 5: Typical values represent the most likely parametric norm.

Note 6: All limits are guaranteed by testing or statistical analysis.

Note 7: Positive current corresponds to current flowing into the device.

Note 8: Slew rate is the average of the rising and falling slew rates.

Note 9: Machine Model, 0Ω in series with 200pF.

Note 10: Short circuit test is a momentary test. See Note 11.

Note 11: Output short circuit duration is infinite for $V_S < 6V$ at room temperature and below. For $V_S > 6V$, allowable short circuit duration is 1.5ms.

Note 12: Offset voltage average drift determined by dividing the change in V_{OS} at temperature extremes by the total temperature change.

Note 13: CDM: Charge Device Model

Connection Diagrams

5-Pin SOT23 (LMH6642)

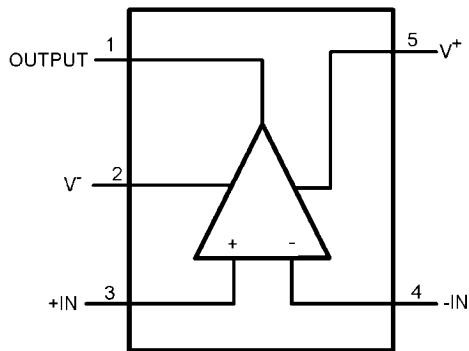

Top View

20018561

8-Pin SOIC (LMH6642)

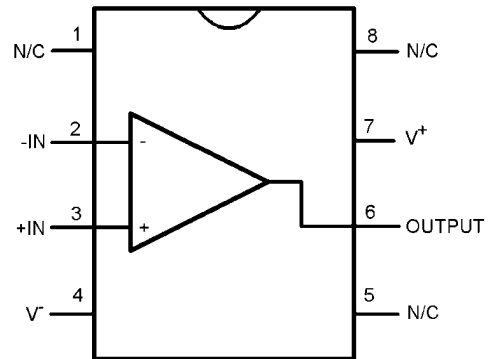

Top View

20018562

8-Pin SOIC and 8-Pin MSOP (LMH6643)

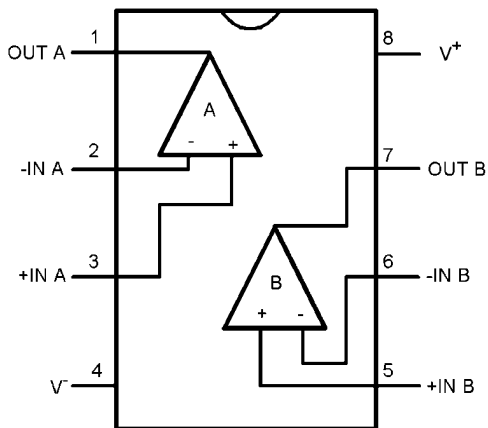

Top View

20018563

14-Pin SOIC and 14-Pin TSSOP (LMH6644)

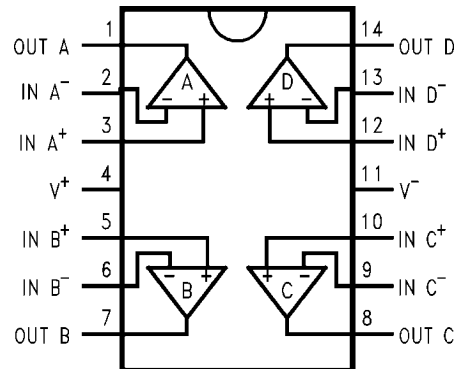

Top View

20018568

Typical Performance Characteristics

specified.

At $T_j = 25^\circ\text{C}$, $V^+ = +5$, $V^- = -5\text{V}$, $R_F = R_L = 2\text{k}\Omega$. Unless otherwise

Closed Loop Frequency Response for Various Supplies

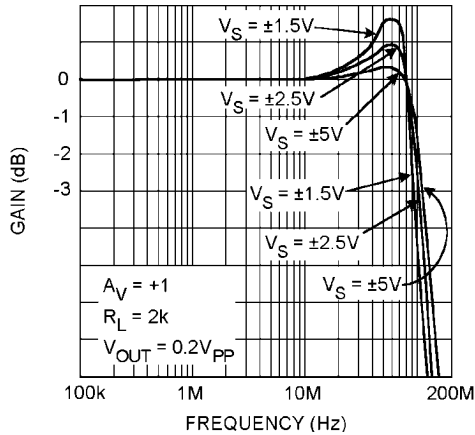

20018557

Closed Loop Gain vs. Frequency for Various Gain

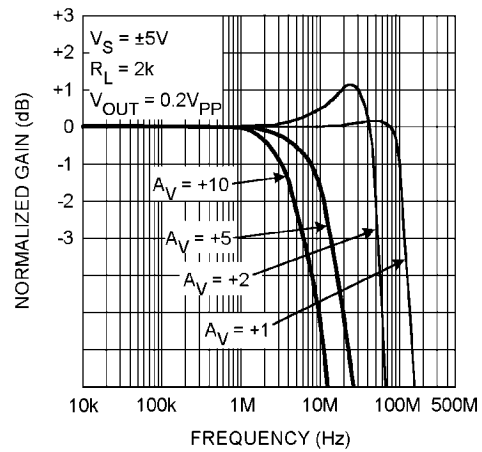

20018551

Closed Loop Gain vs. Frequency for Various Gain

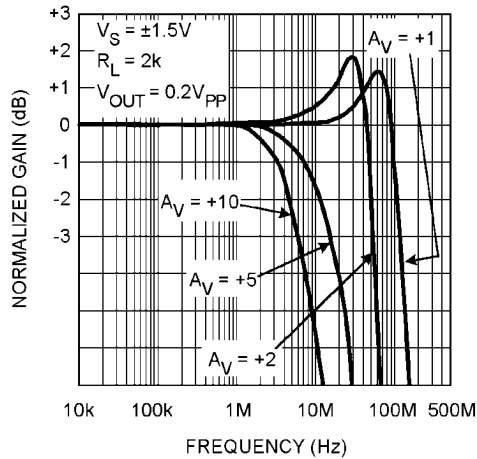

20018535

Closed Loop Frequency Response for Various Temperature

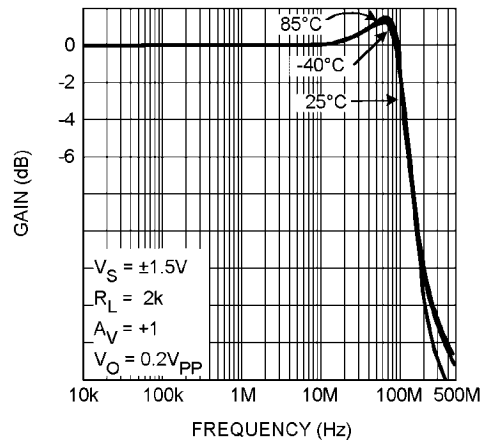

20018550

Closed Loop Gain vs. Frequency for Various Supplies

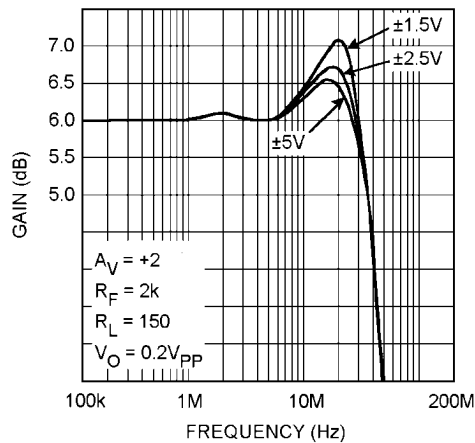

20018548

Closed Loop Frequency Response for Various Temperature

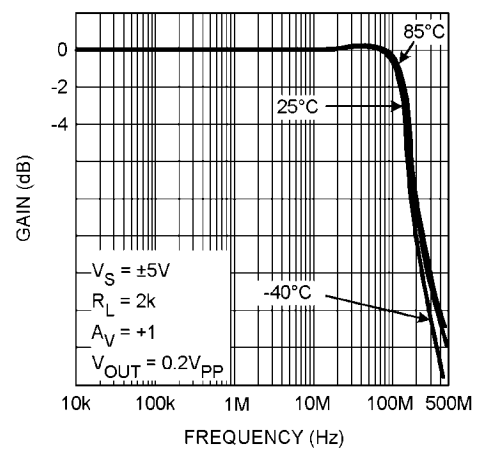

20018534

Large Signal Frequency Response

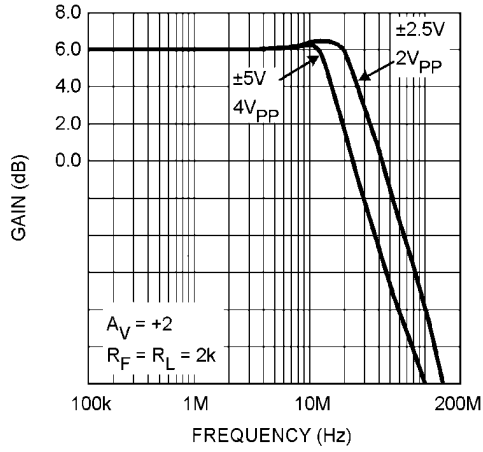

20018547

Closed Loop Small Signal Frequency Response for Various Supplies

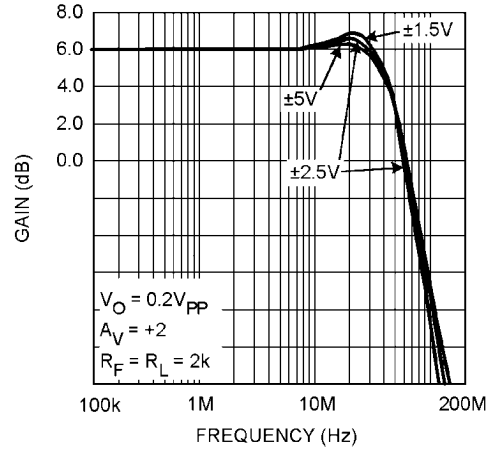

20018546

Closed Loop Frequency Response for Various Supplies

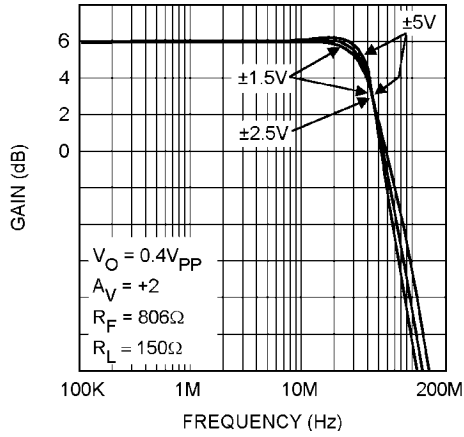

20018544

±0.1dB Gain Flatness for Various Supplies

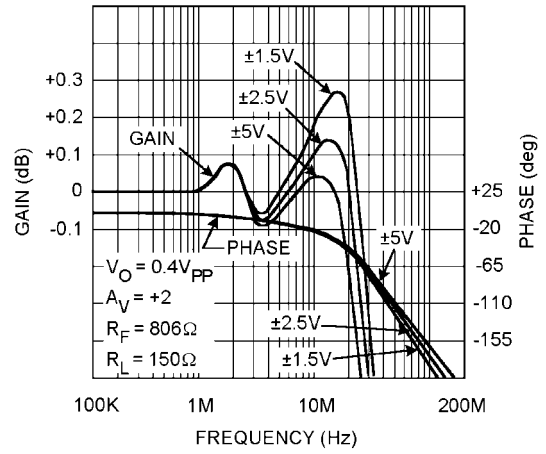

20018545

$V_{OUT} (V_{PP})$ for THD < 0.5%

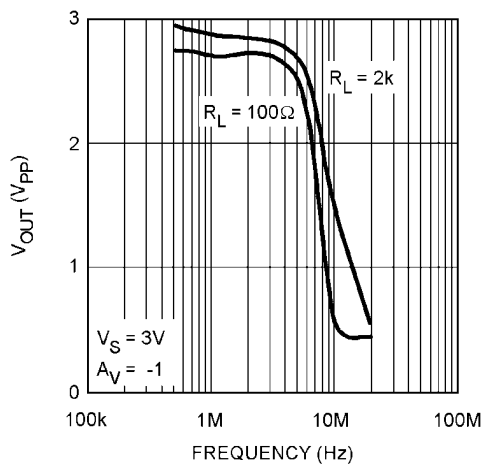

20018509

$V_{OUT} (V_{PP})$ for THD < 0.5%

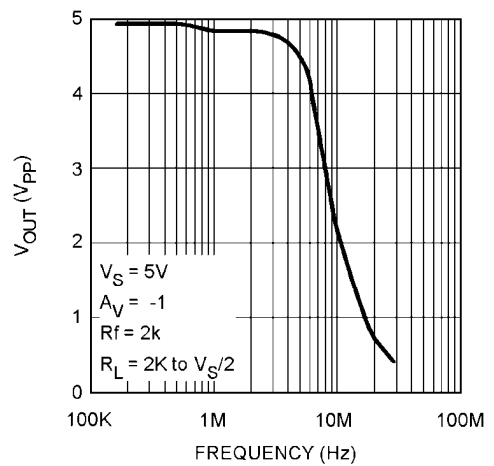

20018508

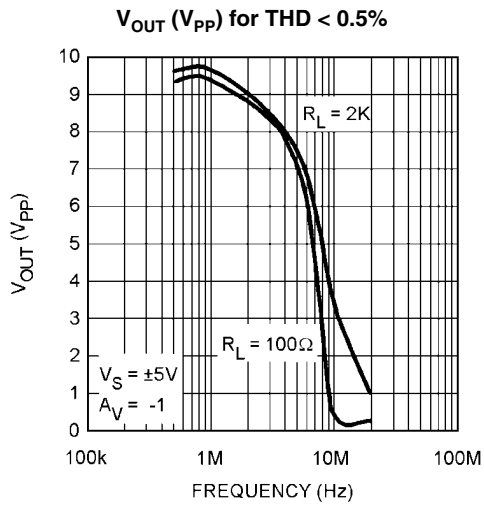

20018510

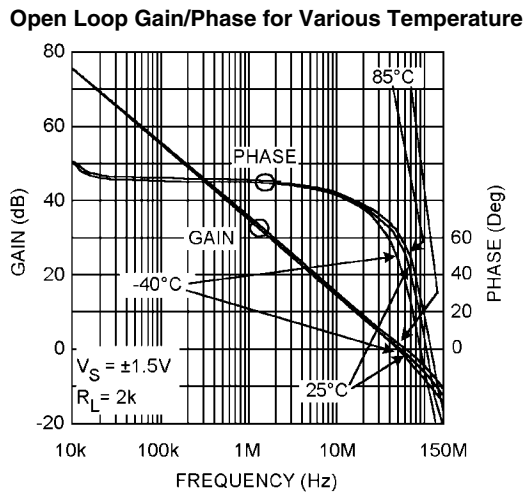

20018532

Open Loop Gain/Phase for Various Temperature

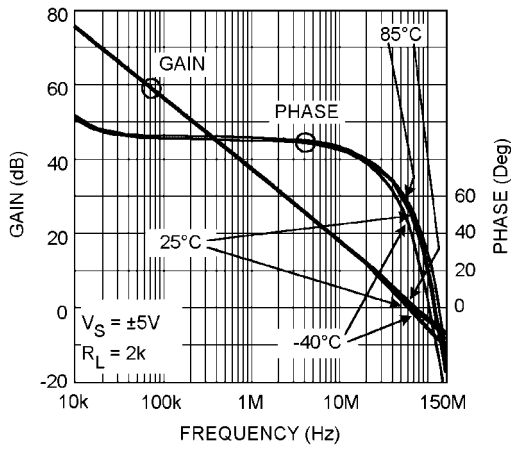

20018533

HD2 (dBc) vs. Output Swing

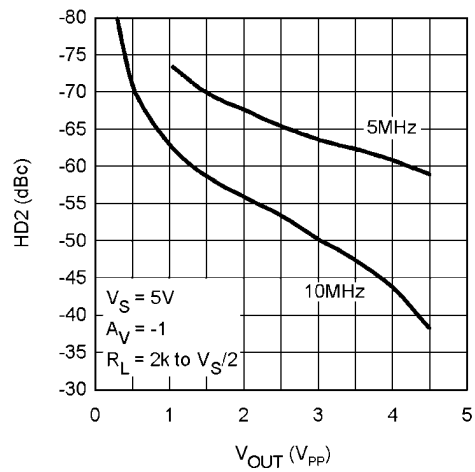

20018514

HD3 (dBc) vs. Output Swing

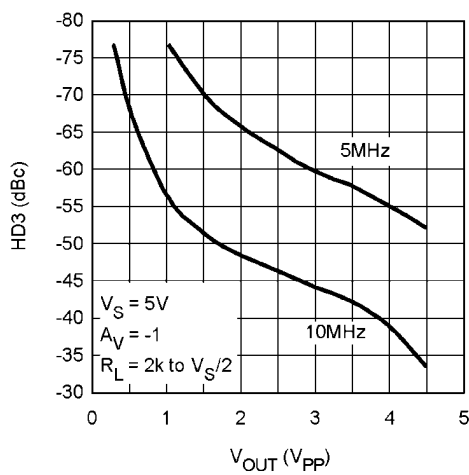

20018515

HD2 vs. Output Swing

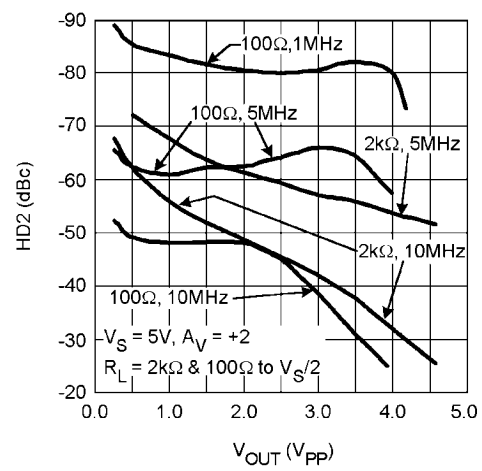

20018504

HD3 vs. Output Swing

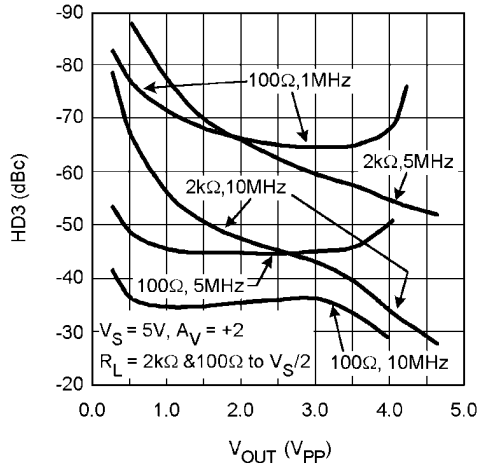

20018505

THD (dBc) vs. Output Swing

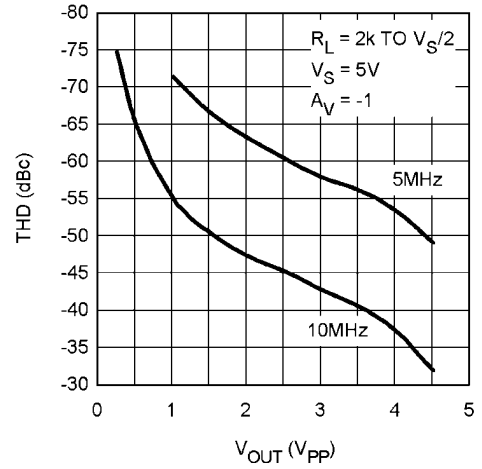

20018506

Settling Time vs. Input Step Amplitude (Output Slew and Settle Time)

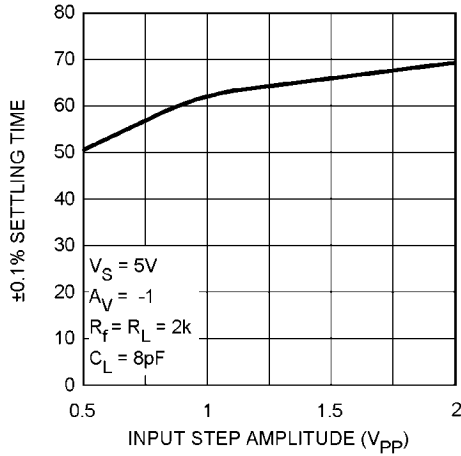

20018513

Input Noise vs. Frequency

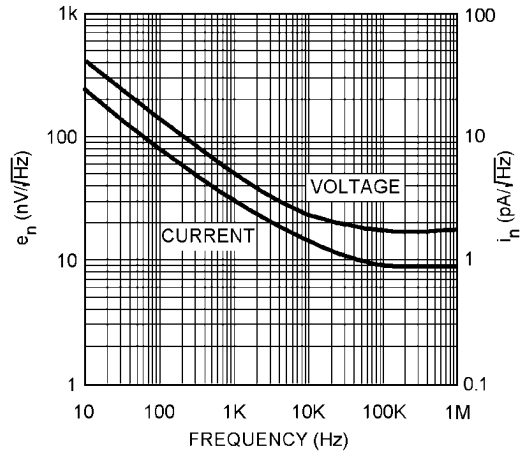

20018512

VOUT from V+ vs. ISOURCE

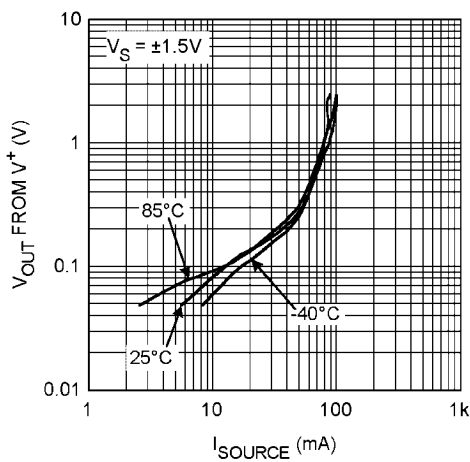

20018518

VOUT from V- vs. ISINK

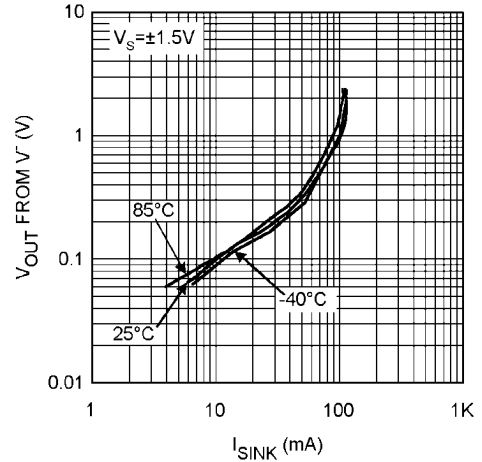

20018519

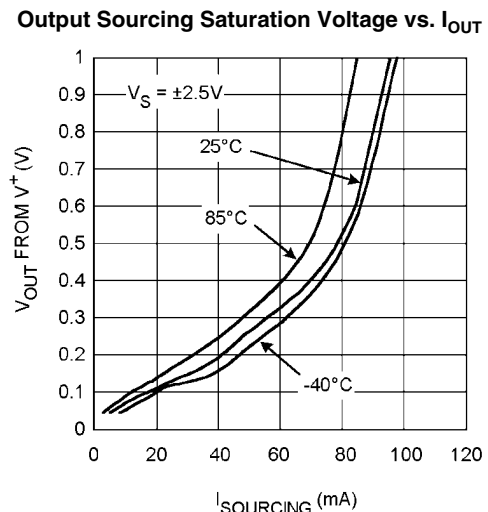
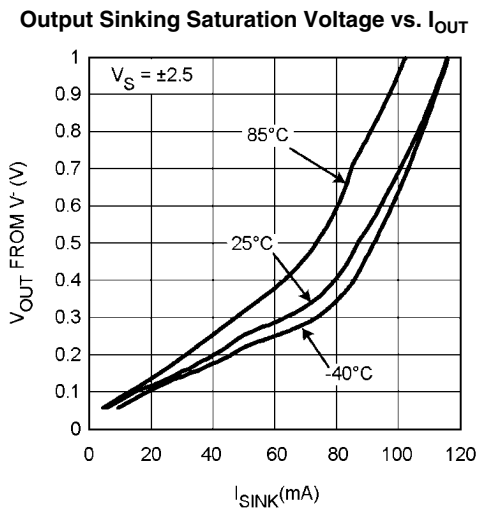
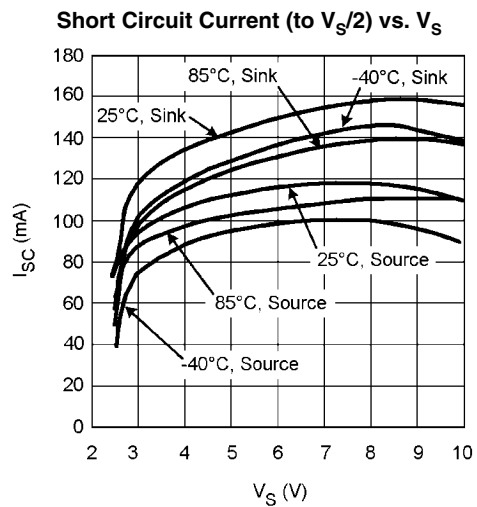
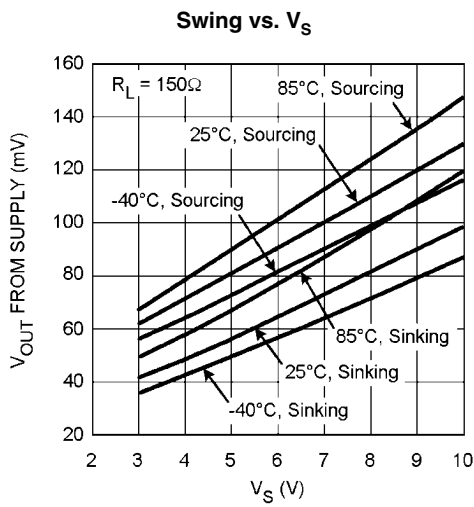
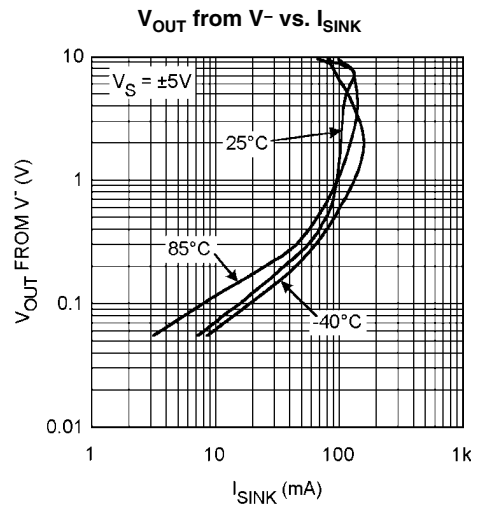
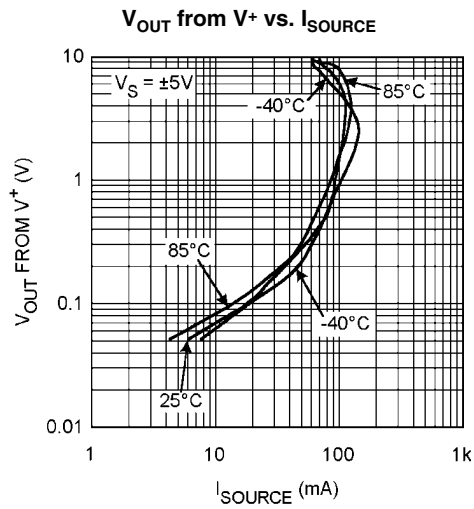

Closed Loop Output Impedance vs. Frequency $A_V = +1$

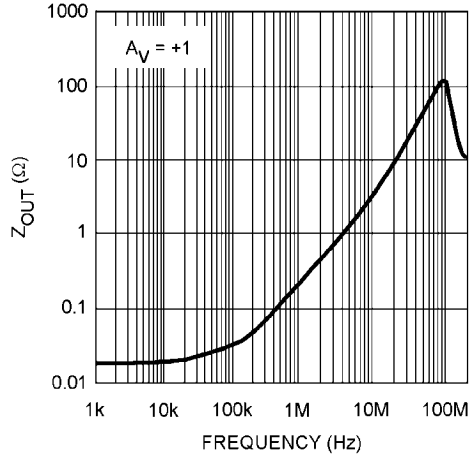

20018502

PSRR vs. Frequency

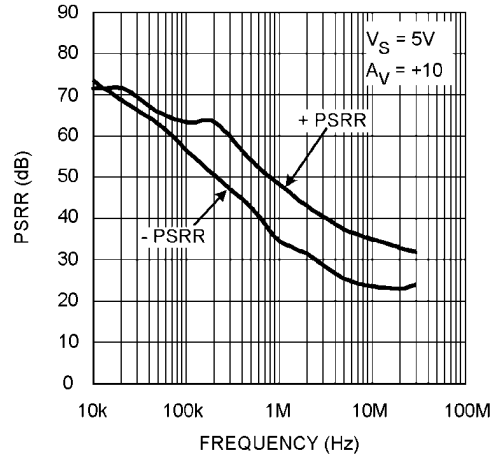

20018503

CMRR vs. Frequency

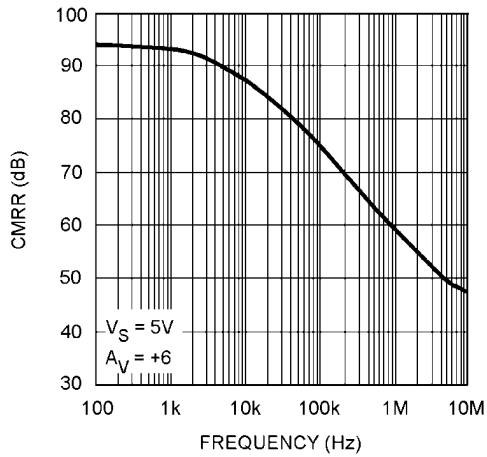

20018507

Crosstalk Rejection vs. Frequency (Output to Output)

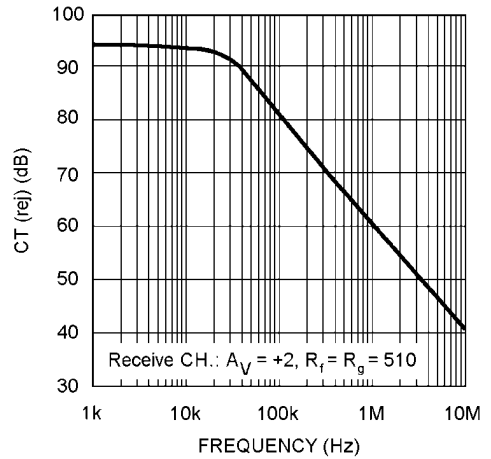

20018511

V_{OS} vs. V_{OUT} (Typical Unit)

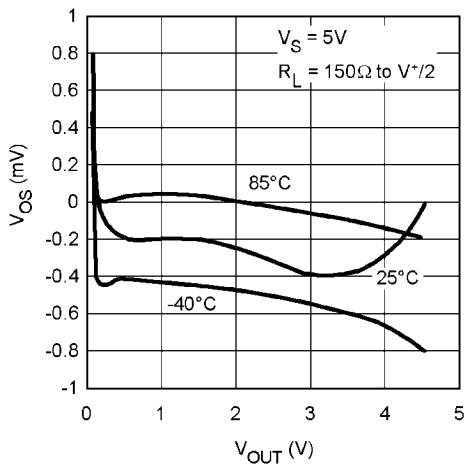

20018530

V_{OS} vs. V_{CM} (Typical Unit)

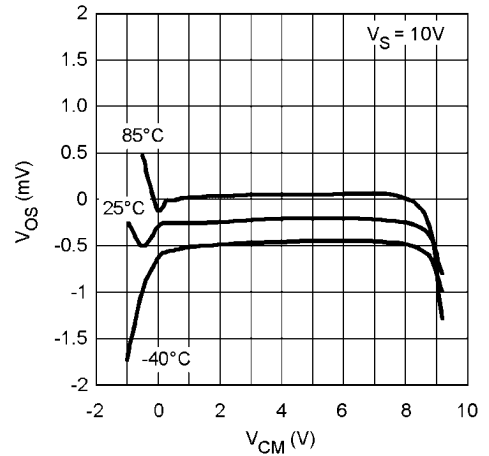

20018527

V_{OS} vs. V_S (for 3 Representative Units)

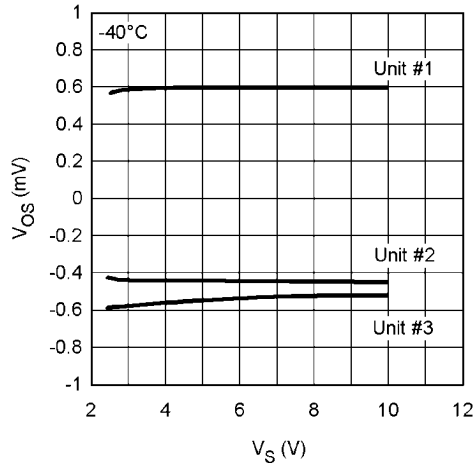

20018522

V_{OS} vs. V_S (for 3 Representative Units)

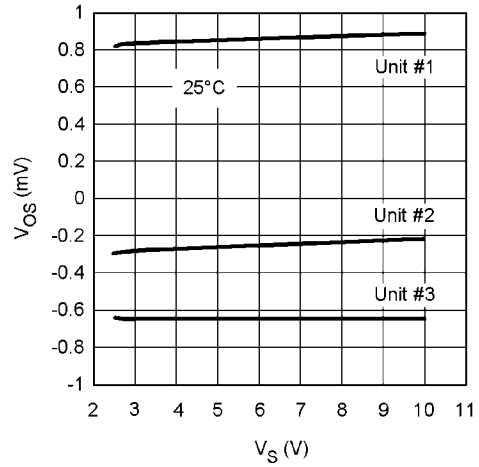

20018523

V_{OS} vs. V_S (for 3 Representative Units)

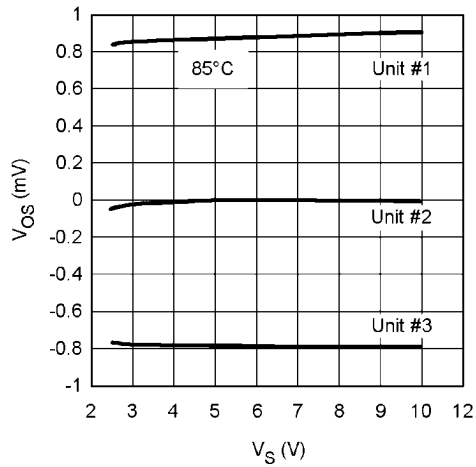

20018524

I_B vs. V_S

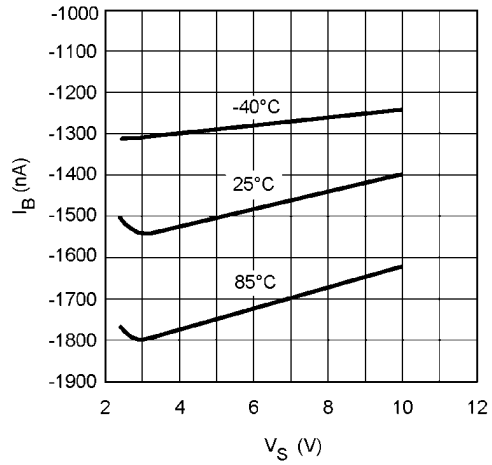

20018525

I_{OS} vs. V_S

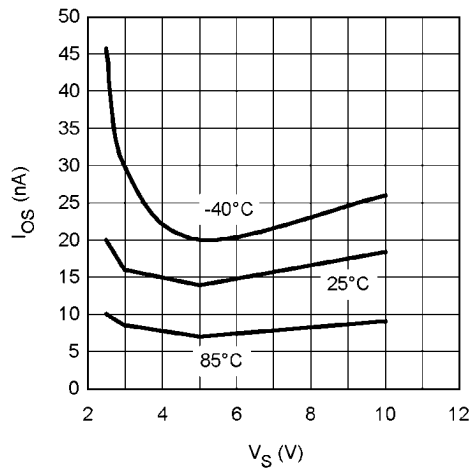

20018526

I_S vs. V_{CM}

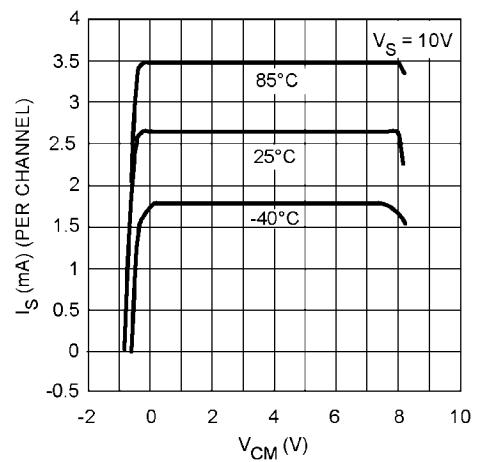

20018528

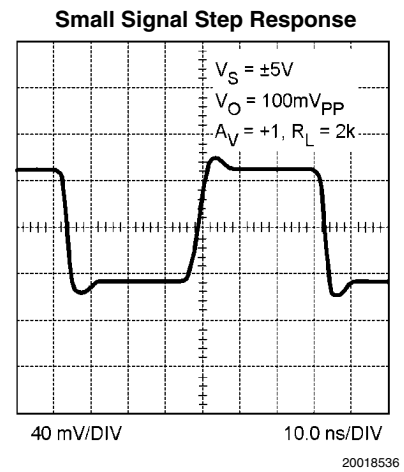
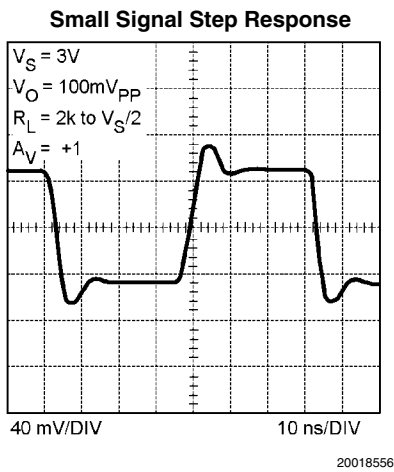
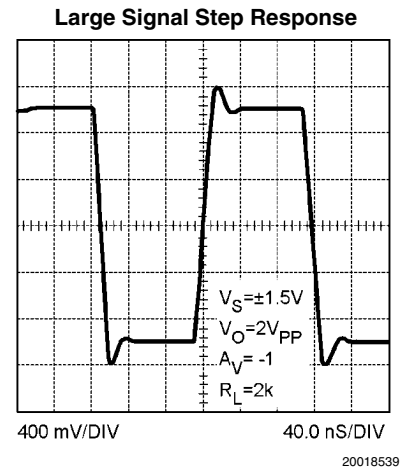
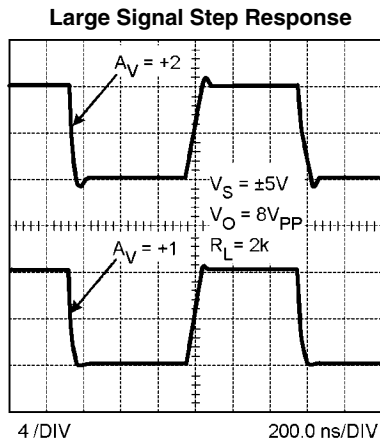
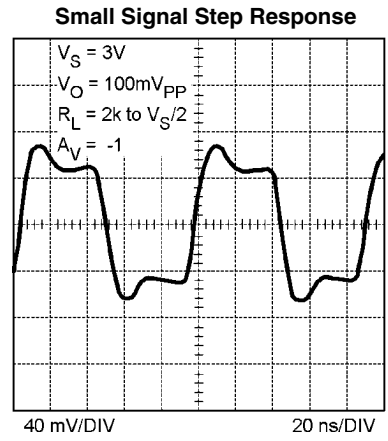
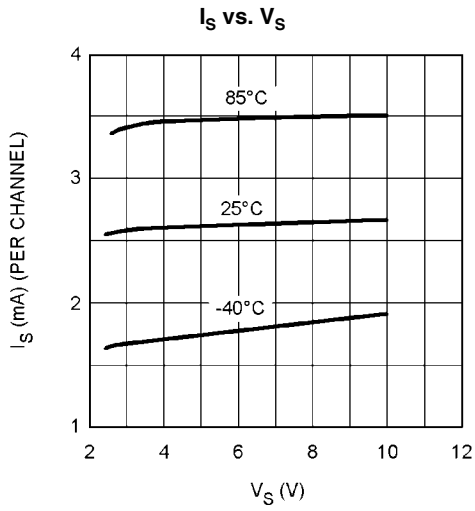

Small Signal Step Response

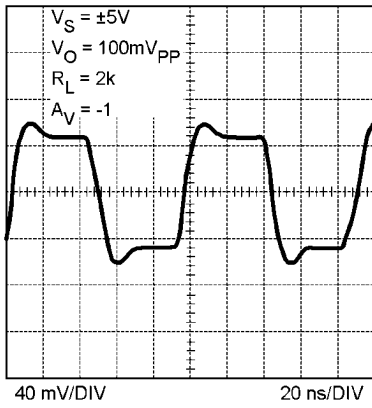

20018552

Small Signal Step Response

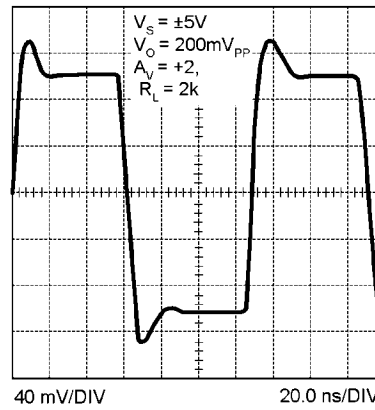

20018538

Large Signal Step Response

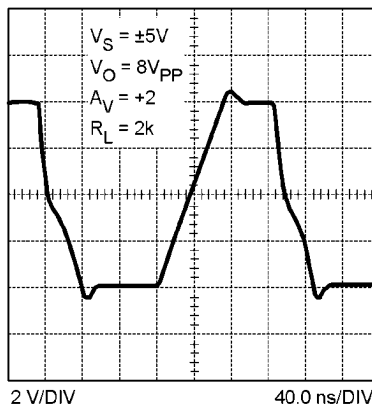

20018537

Large Signal Step Response

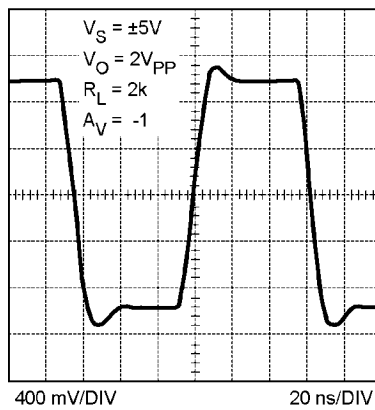

20018554

Large Signal Step Response

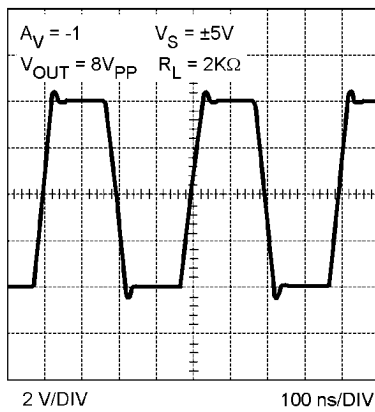

20018560

Application Information

CIRCUIT DESCRIPTION

The LMH664X family is based on National Semiconductor's proprietary VIP10 dielectrically isolated bipolar process.

This device family architecture features the following:

- Complimentary bipolar devices with exceptionally high f_t (~8GHz) even under low supply voltage (2.7V) and low bias current.
- A class A-B "turn-around" stage with improved noise, offset, and reduced power dissipation compared to similar speed devices (patent pending).
- Common Emitter push-push output stage capable of 75mA output current (at 0.5V from the supply rails) while consuming only 2.7mA of total supply current per channel. This architecture allows output to reach within milli-volts of either supply rail.
- Consistent performance over the entire operating supply voltage range with little variation for the most important specifications (e.g. BW, SR, I_{OUT} , etc.)
- Significant power saving (~40%) compared to competitive devices on the market with similar performance.

Application Hints

This Op Amp family is a drop-in replacement for the AD805X family of high speed Op Amps in most applications. In addition, the LMH664X will typically save about 40% on power dissipation, due to lower supply current, when compared to competition. All AD805X family's guaranteed parameters are included in the list of LMH664X guaranteed specifications in order to ensure equal or better level of performance. However, as in most high performance parts, due to subtleties of applications, it is strongly recommended that the performance of the part to be evaluated is tested under actual operating conditions to ensure full compliance to all specifications.

With 3V supplies and a common mode input voltage range that extends 0.5V below V^- , the LMH664X find applications in low voltage/low power applications. Even with 3V supplies, the -3dB BW (@ $A_V = +1$) is typically 115MHz with a tested limit of 80MHz. Production testing guarantees that process variations will not compromise speed. High frequency response is exceptionally stable confining the typical -3dB BW over the industrial temperature range to $\pm 2.5\%$.

As can be seen from the typical performance plots, the LMH664X output current capability (~75mA) is enhanced compared to AD805X. This enhancement, increases the output load range, adding to the LMH664X's versatility.

Because of the LMH664X's high output current capability attention should be given to device junction temperature in order not to exceed the Absolute Maximum Rating.

This device family was designed to avoid output phase reversal. With input overdrive, the output is kept near supply rail (or as closed to it as mandated by the closed loop gain setting and the input voltage). See [Figure 1](#):

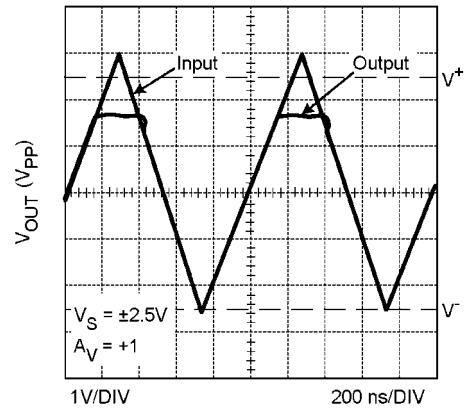

20018542

FIGURE 1. Input and Output Shown with CMVR Exceeded

However, if the input voltage range of $-0.5V$ to $1V$ from V^+ is exceeded by more than a diode drop, the internal ESD protection diodes will start to conduct. The current in the diodes should be kept at or below 10mA.

Output overdrive recovery time is less than 100ns as can be seen from [Figure 2](#) plot:

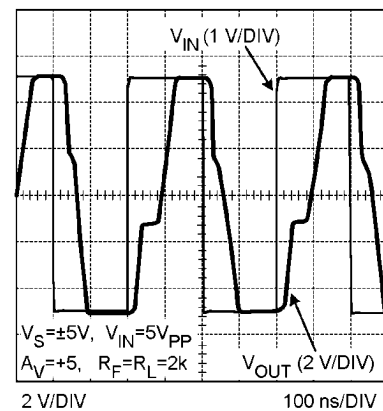

20018543

FIGURE 2. Overload Recovery Waveform

INPUT AND OUTPUT TOPOLOGY

All input / output pins are protected against excessive voltages by ESD diodes connected to V^+ and V^- rails (see [Figure 3](#)). These diodes start conducting when the input / output pin voltage approaches $1V_{be}$ beyond V^+ or V^- to protect against over voltage. These diodes are normally reverse biased. Further protection of the inputs is provided by the two resistors (R in [Figure 3](#)), in conjunction with the string of anti-parallel diodes connected between both bases of the input stage. The combination of these resistors and diodes reduces excessive differential input voltages approaching $2V_{be}$. The most common situation when this occurs is when the device is used as a comparator (or with little or no feedback) and the device inputs no longer follow each other. In such a case, the diodes may conduct. As a consequence, input current increases and the differential input voltage is clamped. It is important to make sure that the subsequent current flow through the device input pins does not violate the Absolute Maximum Ratings of the device. To limit the current through this protection circuit, extra series resistors can be placed. Together with the built-in series resistors of several hundred ohms, these ex-

ternal resistors can limit the input current to a safe number (i.e. < 10mA). Be aware that these input series resistors may impact the switching speed of the device and could slow down the device.

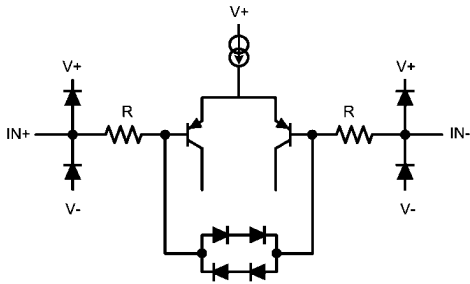

20018569

FIGURE 3. Input Equivalent Circuit

SINGLE SUPPLY, LOW POWER PHOTODIODE AMPLIFIER

The circuit shown in Figure 4 is used to amplify the current from a photo-diode into a voltage output. In this circuit, the emphasis is on achieving high bandwidth and the transimpedance gain setting is kept relatively low. Because of its high slew rate limit and high speed, the LMH664X family lends itself well to such an application.

This circuit achieves approximately 1V/mA of transimpedance gain and capable of handling up to 1mA_{pp} from the photodiode. Q1, in a common base configuration, isolates the high capacitance of the photodiode (C_d) from the Op Amp input in order to maximize speed. Input is AC coupled through

C1 to ease biasing and allow single supply operation. With 5V single supply, the device input/output is shifted to near half supply using a voltage divider from V_{CC}. Note that Q1 collector does not have any voltage swing and the Miller effect is minimized. D1, tied to Q1 base, is for temperature compensation of Q1's bias point. Q1 collector current was set to be large enough to handle the peak-to-peak photodiode excitation and not too large to shift the U1 output too far from mid-supply.

No matter how low an R_f is selected, there is a need for C_f in order to stabilize the circuit. The reason for this is that the Op Amp input capacitance and Q1 equivalent collector capacitance together (C_{IN}) will cause additional phase shift to the signal fed back to the inverting node. C_f will function as a zero in the feedback path counter-acting the effect of the C_{IN} and acting to stabilize the circuit. By proper selection of C_f such that the Op Amp open loop gain is equal to the inverse of the feedback factor at that frequency, the response is optimized with a theoretical 45° phase margin.

$$C_f = \sim \text{SQRT} \left[\frac{C_{IN}}{(2\pi \cdot \text{GBWP} \cdot R_f)} \right] \tag{1}$$

where GBWP is the Gain Bandwidth Product of the Op Amp Optimized as such, the I-V converter will have a theoretical pole, f_p, at:

$$f_p = \text{SQRT} \left[\frac{\text{GBWP}}{(2\pi R_f \cdot C_{IN})} \right] \tag{2}$$

With Op Amp input capacitance of 3pF and an estimate for Q1 output capacitance of about 3pF as well, C_{IN} = 6pF. From the typical performance plots, LMH6642/6643 family GBWP is approximately 57MHz. Therefore, with R_f = 1k, from Equation 1 and 2 above.

C_f = ~4.1pF, and f_p = 39MHz

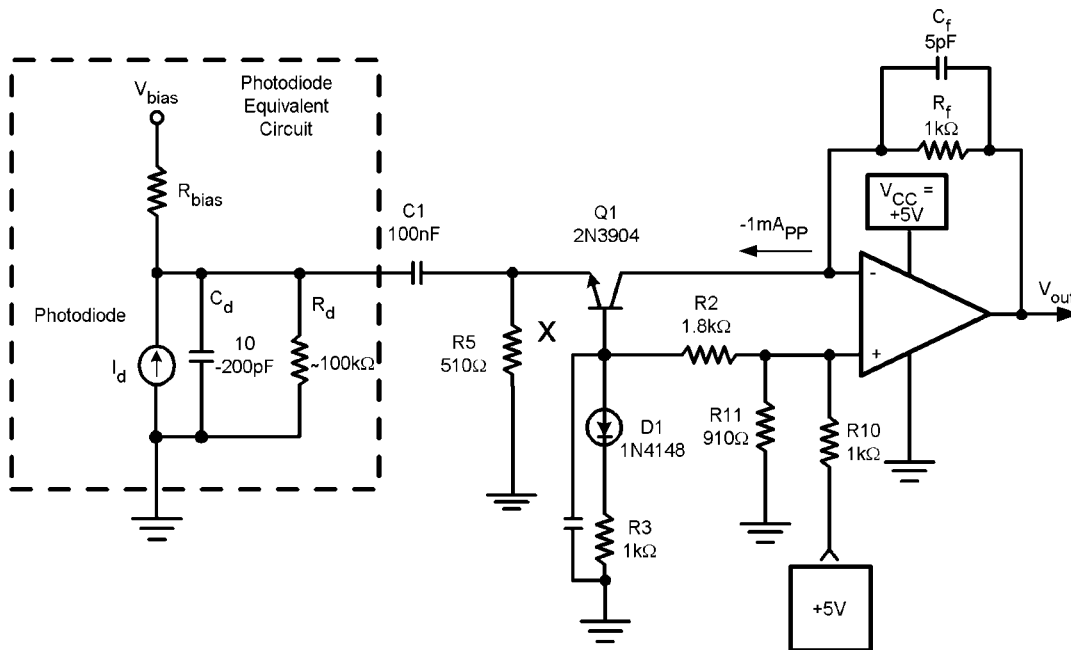

20018564

FIGURE 4. Single Supply Photodiode I-V Converter

For this example, optimum C_f was empirically determined to be around 5pF. This time domain response is shown in [Figure 5](#) below showing about 9ns rise/fall times, corresponding to about 39MHz for f_p . The overall supply current from the +5V supply is around 5mA with no load.

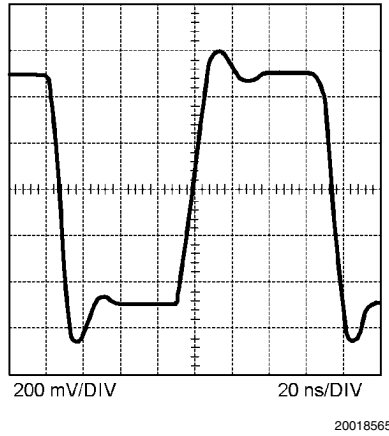

FIGURE 5. Converter Step Response (1V_{pp}, 20 ns/DIV)

PRINTED CIRCUIT BOARD LAYOUT AND COMPONENT VALUES SECTION

Generally, a good high frequency layout will keep power supply and ground traces away from the inverting input and output pins. Parasitic capacitances on these nodes to ground will cause frequency response peaking and possible circuit oscillations (see Application Note OA-15 for more information). National Semiconductor suggests the following evaluation boards as a guide for high frequency layout and as an aid in device testing and characterization:

Device	Package	Evaluation Board PN
LMH6642MF	5-Pin SOT-23	LMH730216
LMH6642MA	8-Pin SOIC	LMH730227
LMH6643MA	8-Pin SOIC	LMH730036
LMH6643MM	8-Pin MSOP	LMH730123
LMH6644MA	14-Pin SOIC	LMH730231
LMH6644MT	14-Pin TSSOP	LMH730131

Another important parameter in working with high speed/high performance amplifiers, is the component values selection. Choosing external resistors that are large in value will effect the closed loop behavior of the stage because of the interaction of these resistors with parasitic capacitances. These capacitors could be inherent to the device or a by-product of the board layout and component placement. Either way, keeping the resistor values lower, will diminish this interaction to a large extent. On the other hand, choosing very low value resistors could load down nodes and will contribute to higher overall power dissipation.

Ordering Information

Package	Part Number	Package Marking	Transport Media	NSC Drawing
5-Pin SOT-23	LMH6642MF	A64A	1k Units Tape and Reel	MF05A
	LMH6642MFX		3k Units Tape and Reel	
8-Pin SOIC	LMH6642MA	LMH6642MA	95 Units/Rail	M08A
	LMH6642MAX		2.5k Units Tape and Reel	
	LMH6643MA	LMH6643MA	95 Units/Rail	
	LMH6643MAX		2.5k Units Tape and Reel	
8-Pin MSOP	LMH6643MM	A65A	1k Units Tape and Reel	MUA08A
	LMH6643MMX		3.5k Units Tape and Reel	
14-Pin SOIC	LMH6644MA	LMH6644MA	55 units/Rail	M14A
	LMH6644MAX		2.5k Units Tape and Reel	
14-Pin TSSO	LMH6644MT	LMH6644MT	94 Units/Rail	MTC14
	LMH6644MTX		2.5k Units Tape and Reel	

Physical Dimensions inches (millimeters) unless otherwise noted

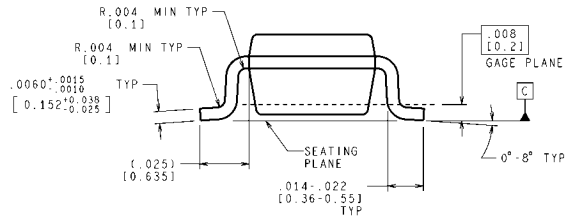
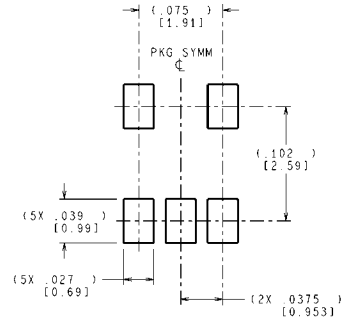
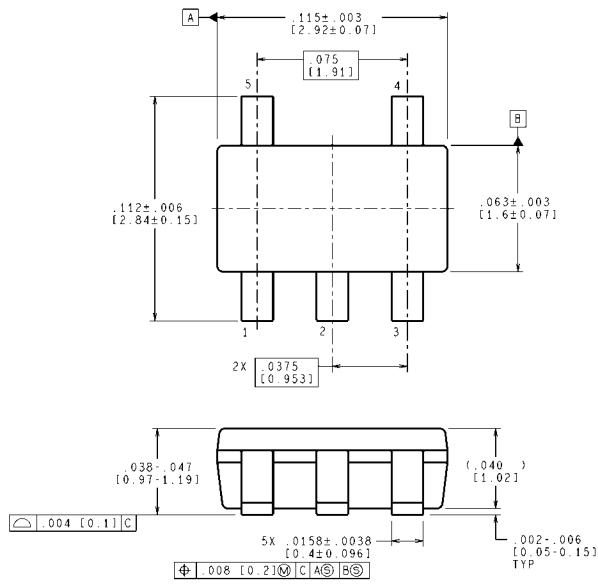

CONTROLLING DIMENSION IS INCH
VALUES IN [] ARE MILLIMETERS
DIMENSIONS IN () FOR REFERENCE ONLY

MF05A (Rev D)

5-Pin SOT23
NS Package Number MF05A

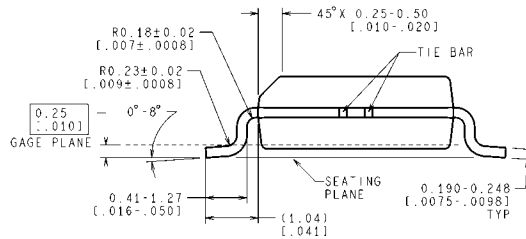
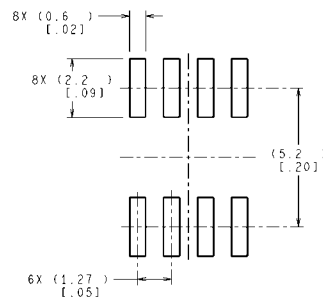
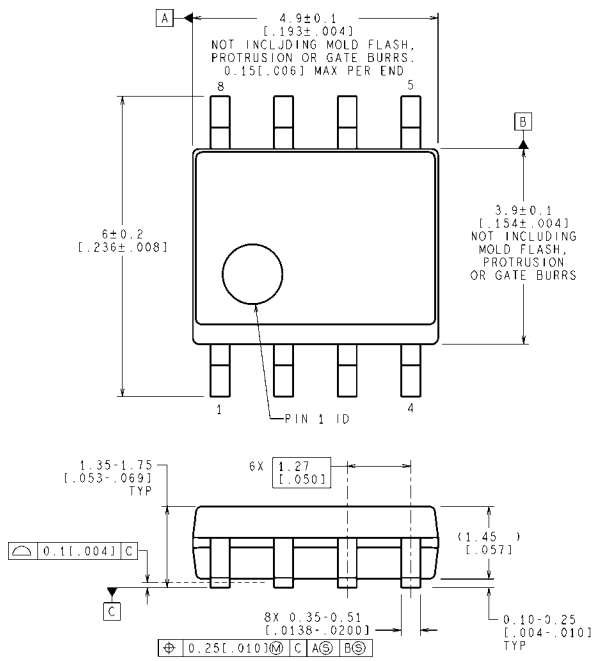

CONTROLLING DIMENSION IS MILLIMETER
VALUES IN [] ARE INCHES
DIMENSIONS IN () FOR REFERENCE ONLY

M08A (Rev M)

8-Pin SOIC
NS Package Number M08A

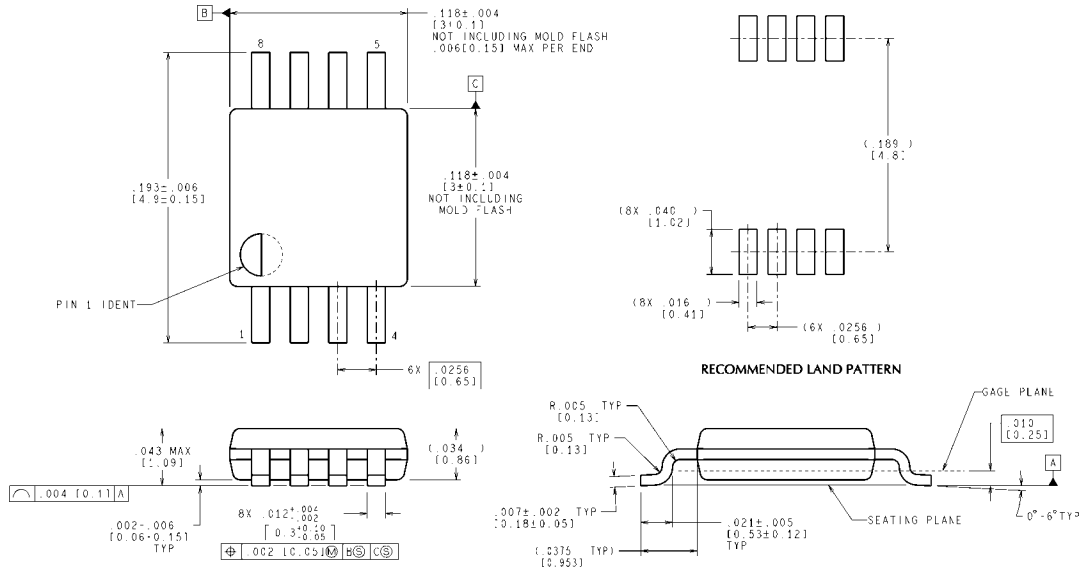

CONTROLLING DIMENSION IS INCH
VALUES IN [] ARE MILLIMETERS

8-Pin MSOP
NS Package Number MUA08A

MUA08A (Rev F)

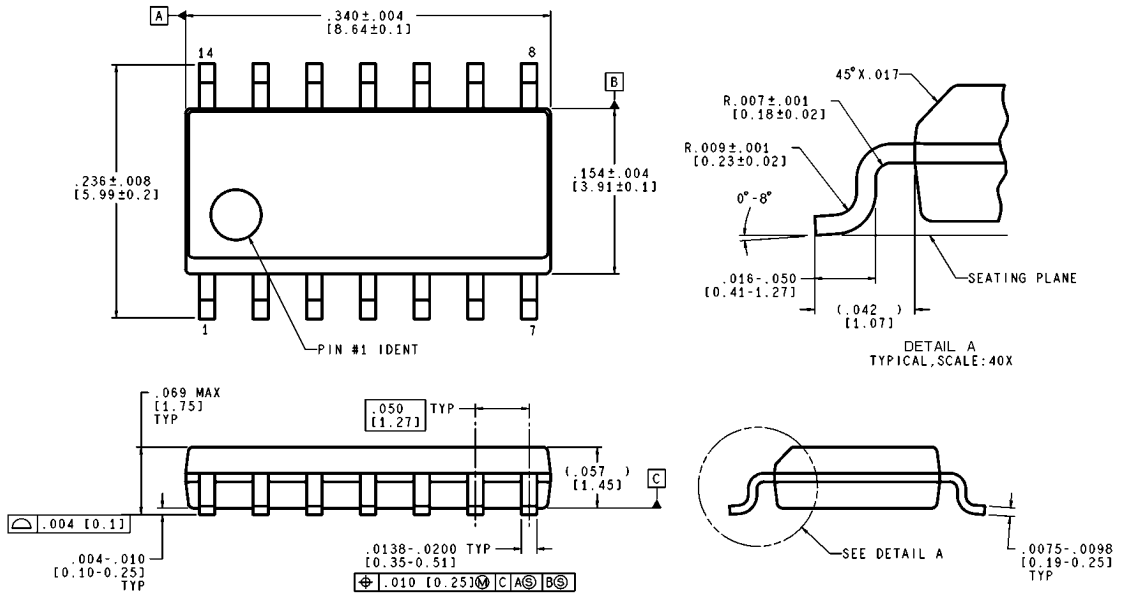

CONTROLLING DIMENSION IS INCH
VALUES IN [] ARE MILLIMETERS

14-Pin SOIC
NS Package Number M14A

M14A (Rev J)

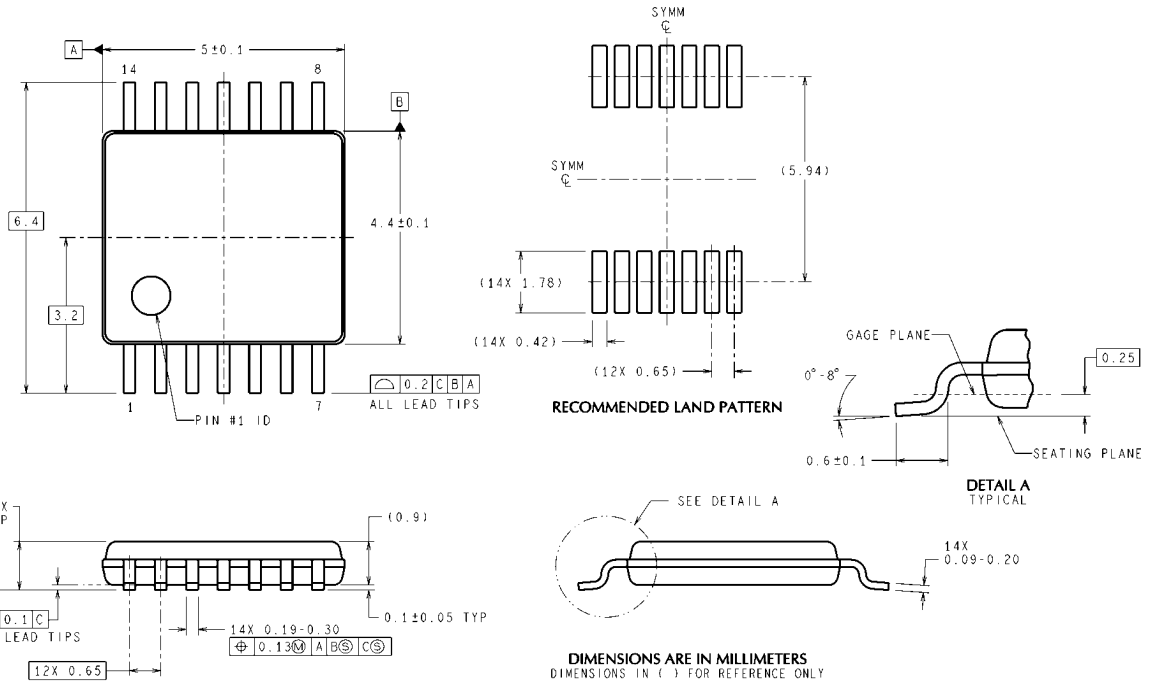

DIMENSIONS ARE IN MILLIMETERS
DIMENSIONS IN () FOR REFERENCE ONLY

MTC14 (Rev D)

14-Pin TSSOP
NS Package Number MTC14

Notes

IMPORTANT NOTICE

Texas Instruments Incorporated and its subsidiaries (TI) reserve the right to make corrections, modifications, enhancements, improvements, and other changes to its products and services at any time and to discontinue any product or service without notice. Customers should obtain the latest relevant information before placing orders and should verify that such information is current and complete. All products are sold subject to TI's terms and conditions of sale supplied at the time of order acknowledgment.

TI warrants performance of its hardware products to the specifications applicable at the time of sale in accordance with TI's standard warranty. Testing and other quality control techniques are used to the extent TI deems necessary to support this warranty. Except where mandated by government requirements, testing of all parameters of each product is not necessarily performed.

TI assumes no liability for applications assistance or customer product design. Customers are responsible for their products and applications using TI components. To minimize the risks associated with customer products and applications, customers should provide adequate design and operating safeguards.

TI does not warrant or represent that any license, either express or implied, is granted under any TI patent right, copyright, mask work right, or other TI intellectual property right relating to any combination, machine, or process in which TI products or services are used. Information published by TI regarding third-party products or services does not constitute a license from TI to use such products or services or a warranty or endorsement thereof. Use of such information may require a license from a third party under the patents or other intellectual property of the third party, or a license from TI under the patents or other intellectual property of TI.

Reproduction of TI information in TI data books or data sheets is permissible only if reproduction is without alteration and is accompanied by all associated warranties, conditions, limitations, and notices. Reproduction of this information with alteration is an unfair and deceptive business practice. TI is not responsible or liable for such altered documentation. Information of third parties may be subject to additional restrictions.

Resale of TI products or services with statements different from or beyond the parameters stated by TI for that product or service voids all express and any implied warranties for the associated TI product or service and is an unfair and deceptive business practice. TI is not responsible or liable for any such statements.

TI products are not authorized for use in safety-critical applications (such as life support) where a failure of the TI product would reasonably be expected to cause severe personal injury or death, unless officers of the parties have executed an agreement specifically governing such use. Buyers represent that they have all necessary expertise in the safety and regulatory ramifications of their applications, and acknowledge and agree that they are solely responsible for all legal, regulatory and safety-related requirements concerning their products and any use of TI products in such safety-critical applications, notwithstanding any applications-related information or support that may be provided by TI. Further, Buyers must fully indemnify TI and its representatives against any damages arising out of the use of TI products in such safety-critical applications.

TI products are neither designed nor intended for use in military/aerospace applications or environments unless the TI products are specifically designated by TI as military-grade or "enhanced plastic." Only products designated by TI as military-grade meet military specifications. Buyers acknowledge and agree that any such use of TI products which TI has not designated as military-grade is solely at the Buyer's risk, and that they are solely responsible for compliance with all legal and regulatory requirements in connection with such use.

TI products are neither designed nor intended for use in automotive applications or environments unless the specific TI products are designated by TI as compliant with ISO/TS 16949 requirements. Buyers acknowledge and agree that, if they use any non-designated products in automotive applications, TI will not be responsible for any failure to meet such requirements.

Following are URLs where you can obtain information on other Texas Instruments products and application solutions:

Products

Audio	www.ti.com/audio
Amplifiers	amplifier.ti.com
Data Converters	dataconverter.ti.com
DLP® Products	www.dlp.com
DSP	dsp.ti.com
Clocks and Timers	www.ti.com/clocks
Interface	interface.ti.com
Logic	logic.ti.com
Power Mgmt	power.ti.com
Microcontrollers	microcontroller.ti.com
RFID	www.ti-rfid.com
OMAP Mobile Processors	www.ti.com/omap
Wireless Connectivity	www.ti.com/wirelessconnectivity

Applications

Automotive and Transportation	www.ti.com/automotive
Communications and Telecom	www.ti.com/communications
Computers and Peripherals	www.ti.com/computers
Consumer Electronics	www.ti.com/consumer-apps
Energy and Lighting	www.ti.com/energy
Industrial	www.ti.com/industrial
Medical	www.ti.com/medical
Security	www.ti.com/security
Space, Avionics and Defense	www.ti.com/space-avionics-defense
Video and Imaging	www.ti.com/video

TI E2E Community Home Page

e2e.ti.com

Mailing Address: Texas Instruments, Post Office Box 655303, Dallas, Texas 75265
Copyright © 2012, Texas Instruments Incorporated