

LM4911,LM4911Q

*LM4911/LM4911Q Stereo 40mW Low Noise Headphone Amplifier with
Selectable Capacitive Coupled or OCL Output*



Literature Number: SNAS152M

Stereo 40mW Low Noise Headphone Amplifier with Selectable Capacitive Coupled or OCL Output

General Description

The LM4911/LM4911Q is a stereo audio power amplifier capable of delivering 40mW per channel of continuous average power into a 16Ω load or 25mW per channel into a 32Ω load at 1% THD+N from a 3V power supply.

Boomer audio power amplifiers were designed specifically to provide high quality output power with a minimal amount of external components. Since the LM4911/LM4911Q does not require bootstrap capacitors or snubber networks, it is optimally suited for low-power portable systems. In addition, the LM4911/LM4911Q may be configured for either single-ended capacitively coupled outputs or for OCL outputs (patent pending).

The LM4911/LM4911Q features a low-power consumption shutdown mode and a power mute mode that allows for faster turn on time with less than 1mV voltage change at outputs on release. Additionally, the LM4911/LM4911Q features an internal thermal shutdown protection mechanism.

The LM4911/LM4911Q is unity gain stable and may be configured with external gain-setting resistors.

A Q-grade version is available for automotive applications. It is AEC-Q100 grade 2 qualified and packaged in a 10-pin MSOP package (LM4911QMM).

Key Specifications

- PSRR at 217Hz and 1kHz 65dB (typ)
- Output Power at 1kHz with $V_{DD} = 2.4V$, 1% THD+N into a 16Ω load 25mW (typ)
- Output Power at 1kHz with $V_{DD} = 3V$, 1% THD+N into a 16Ω load 40mW (typ)
- Shutdown Current 2.0μA (max)
- Output Voltage change on release from Shutdown $V_{DD} = 2.4V$, $R_L = 16\Omega$ (C-Coupled) 1mV (max)
- Mute Current 100μA (max)

Features

- OCL or capacitively coupled outputs (patent pending)
- External gain-setting capability
- Available in space-saving MSOP and LD packages
- Ultra low current shutdown mode
- Mute mode allows fast turn-on (1ms) with less than 1mV change on outputs
- 2V - 5.5V operation
- Ultra low noise
- LM4911QMM is an Automotive Grade product that is AEC-Q100 grade 2 qualified.

Applications

- Portable CD players
- PDAs
- Portable electronics devices
- Automotive

Block Diagram

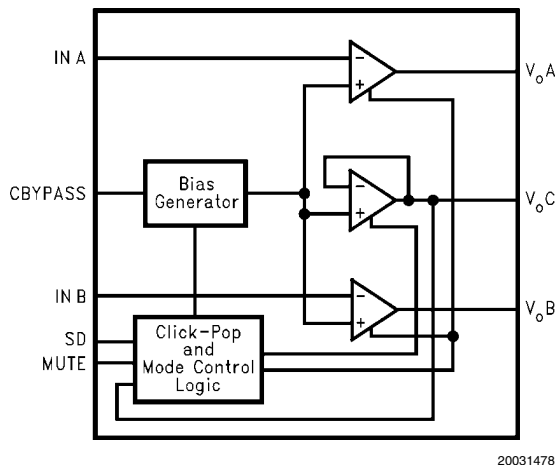
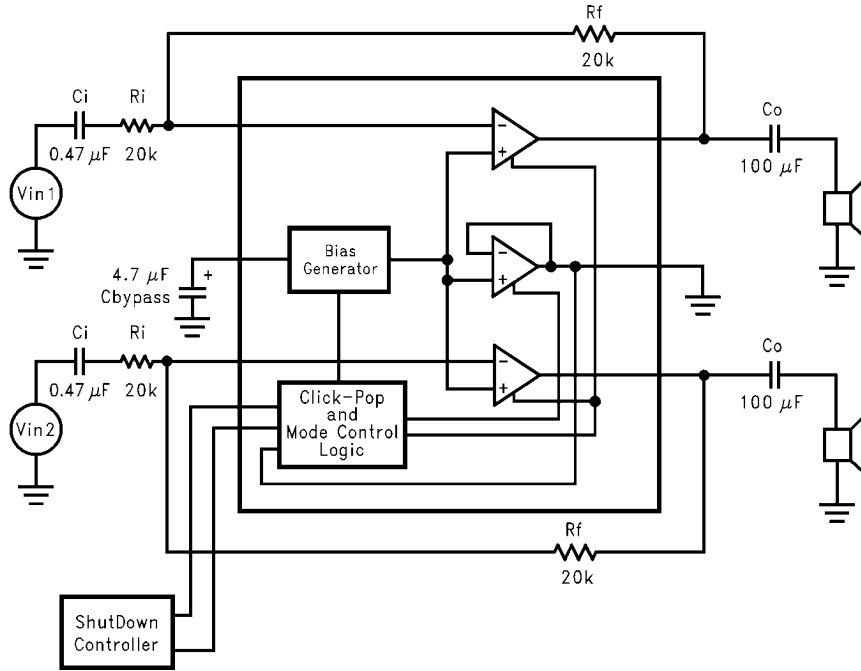

FIGURE 1. Block Diagram

Typical Application



20031480

FIGURE 2. Typical Capacitive Coupled Output Configuration Circuit

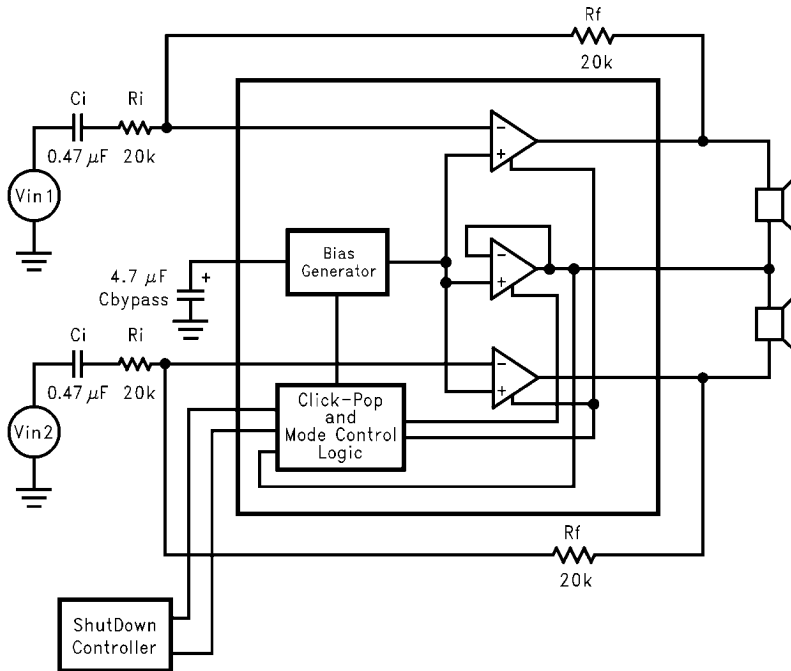

20031481

FIGURE 3. Typical OCL Output Configuration Circuit

Connection Diagrams

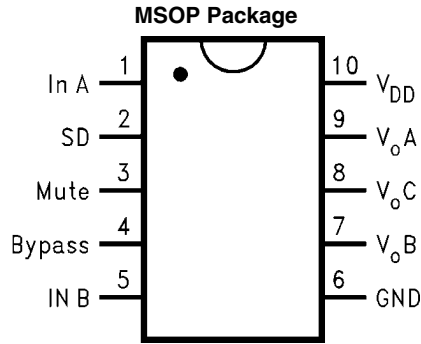

20031479
Top View
 Order Number LM4911/LM4911QMM
 See NS Package Number MUB10A

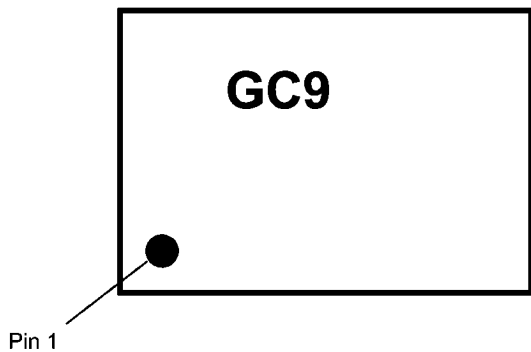
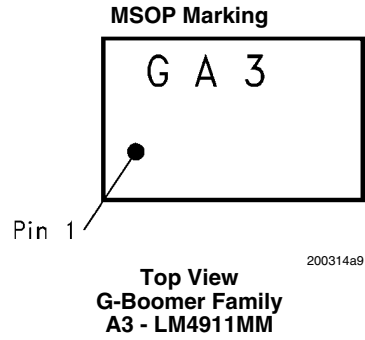

Top View
 G-Boomer Family
 C9 - LM4911QMM

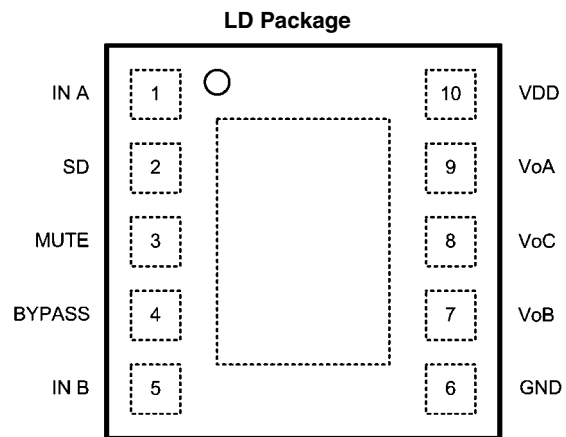

200314c0
Top View
 Order Number LM4911
 See NS Package Number LDA10A

Ordering Information

Order Number	Package	Package Marking	NSC Drawing #	Transport Media
LM4911MM	10-Pin MSOP	GA3	MUB10A	1k units Tape and Reel
LM4911MM	10-Pin MSOP	GA3	MUB10A	3.5k units Tape and Reel
LM4911QMM *	10-Pin MSOP	GC9	MUB10A	1k units Tape and Reel
LM4911QMMX *	10-Pin MSOP	GC9	MUB10A	3.5k units Tape and Reel

* Automotive Grade (Q) product incorporates enhanced manufacturing and support processes for the automotive market, including defect detection methodologies. Reliability qualification is compliant with the requirements and temperature grades defined in the AECQ100 standard. Automotive grade products are identified with the letter Q. For more information, go to <http://www.national.com/automotive>.

Absolute Maximum Ratings (Note 2)

If Military/Aerospace specified devices are required, please contact the National Semiconductor Sales Office/Distributors for availability and specifications.

Supply Voltage	6.0V
Storage Temperature	-65°C to +150°C
Input Voltage	-0.3V to $V_{DD} + 0.3V$
Power Dissipation (Note 3)	Internally Limited
ESD Susceptibility (Note 4)	2000V
ESD Susceptibility (Note 5)	200V
Junction Temperature	150°C
Thermal Resistance	
θ_{JC} (MSOP)	56°C/W

θ_{JA} (MSOP)	190°C/W
θ_{JA} (LD) (Note 10)	63°C/W
θ_{JA} (LD) (Note 10)	12°C/W

Operating Ratings

Temperature Range	
$T_{MIN} \leq T_A \leq T_{MAX}$ (LM4911MM)	-40°C \leq T_A \leq 85°C
$T_{MIN} \leq T_A \leq T_{MAX}$ (LM4911QMM)	-40°C \leq T_A \leq 105°C
Supply Voltage (V_{DD})	2V \leq V_{CC} \leq 5.5V

Electrical Characteristics $V_{DD} = 5.0V$ (Note 1, Note 2)

The following specifications apply for $V_{DD} = 5V$, $R_L = 16\Omega$, and $C_B = 4.7\mu F$ unless otherwise specified. Limits apply to $T_A = 25^\circ C$.

Symbol	Parameter	Conditions	LM4911		LM4911Q		Units (Limits)
			Typ (Note 6)	Limit (Note 7)	Typ (Note 6)	Limit (Note 7)	
I_{DD}	Quiescent Current	$V_{IN} = 0V, I_O = 0A$					
		$T_A = +25^\circ C$	2	5	2	5	mA (max)
		$T_A = -40^\circ C$ to $+105^\circ C$				6	mA (max)
I_{SD}	Shutdown Current	$V_{SHUTDOWN} = GND$	0.1	2	0.1	2	μA (max)
I_M	Mute Current	$V_{MUTE} = V_{DD}, C$ -Coupled					
		$T_A = +25^\circ C$	50	100	50	100	μA (max)
		$T_A = -40^\circ C$ to $+105^\circ C$				150	μA (max)
V_{SDIH}	Shutdown Voltage Input High	$T_A = -40^\circ C$ to $+105^\circ C$	1.8			1.8	V
V_{SDIL}	Shutdown Voltage Input Low	$T_A = -40^\circ C$ to $+105^\circ C$	0.4			0.4	V
V_{MIH}	Mute Voltage Input High	$T_A = -40^\circ C$ to $+105^\circ C$	1.8			1.8	V
V_{MIL}	Mute Voltage Input Low	$T_A = -40^\circ C$ to $+105^\circ C$	0.4			0.4	V
P_O	Output Power	THD \leq 1%, f 1kHz					
		OCL, $R_{LOAD} = 16\Omega$	80				mW (max)
		LM4911/LM4911QLD OCL, $R_{LOAD} = 16\Omega$ (Note 10)	145				mW (max)
		OCL, $R_{LOAD} = 32\Omega$	80				mW (max)
		C-CUPL, $R_{LOAD} = 16\Omega$					
		$T_A = +25^\circ C$	145	134	145		mW (min)
		$T_A = -40^\circ C$ to $+105^\circ C$				130	mW (min)
C-CUPL, $R_{LOAD} = 32\Omega$	85				mW (max)		
THD+N	Total Harmonic Distortion + Noise	$P_O = 15.3mW, f = 1kHz$	0.1	0.5	0.1	0.5	% (max) (Note 11)
PSRR	Power Supply Rejection Ratio	$V_{RIPPLE} = 200mV$ sine p-p f = 1kHz (Note 9)	65		65		dB
V_{ON}	Output Noise Voltage	BW = 20Hz to 20kHz, A-weighted	10		10		μV

Electrical Characteristics $V_{DD} = 3.3V$ (Note 1, Note 2)

The following specifications apply for $V_{DD} = 3.3V$, $R_L = 16\Omega$, and $C_B = 4.7\mu F$ unless otherwise specified.

Limits apply to $T_A = 25^\circ C$.

Symbol	Parameter	Conditions	LM4911		LM4911Q		Units (Limits)
			Typ (Note 6)	Limit (Note 7)	Typ (Note 6)	Limit (Note 7)	
I_{DD}	Quiescent Current	$V_{IN} = 0V, I_O = 0A$					
		$T_A = +25^\circ C$	1.5	3	1.5	3	mA (max)
		$T_A = -40^\circ C$ to $+105^\circ C$				4	mA (max)
I_{SD}	Shutdown Current	$V_{SHUTDOWN} = GND$					
		$T_A = +25^\circ C$	0.1	2	0.1	2	μA (max)
		$T_A = -40^\circ C$ to $+105^\circ C$				4	μA (max)
I_M	Mute Current	$V_{MUTE} = V_{DD}, C$ -Coupled					
		$T_A = +25^\circ C$	50	100	50	100	μA (max)
		$T_A = -40^\circ C$ to $+105^\circ C$				125	μA (max)
V_{SDIH}	Shutdown Voltage Input High	$T_A = -40^\circ C$ to $+105^\circ C$	1.8			1.8	V
V_{SDIL}	Shutdown Voltage Input Low	$T_A = -40^\circ C$ to $+105^\circ C$	0.4			0.4	V
V_{MIH}	Mute Voltage Input High	$T_A = -40^\circ C$ to $+105^\circ C$	1.8			1.8	V
V_{MIL}	Mute Voltage Input Low	$T_A = -40^\circ C$ to $+105^\circ C$	0.4			0.4	V
P_O	Output Power	THD $\leq 1\%$, C-CUPL , $R_L = 16\Omega$					
		$T_A = +25^\circ C$	60	55	60	55	mW (min)
		$T_A = -40^\circ C$ to $+105^\circ C$				50	mW (min)
THD+N	Total Harmonic Distortion + Noise	$P_O = 15.3mW, f = 1kHz$	0.1	0.5	0.1	0.5	% (max) (Note 11)
PSRR	Power Supply Rejection Ratio	$V_{RIPPLE} = 200mV$ sine p-p $f = 1kHz$ (Note 9)	65		65		dB
V_{ON}	Output Noise Voltage	BW = 20Hz to 20kHz, A-weighted	10		10		μV

Electrical Characteristics $V_{DD} = 3.0V$ (Note 1, Note 2)

The following specifications apply for $V_{DD} = 3.0V$, $R_L = 16\Omega$, and $C_B = 4.7\mu F$ unless otherwise specified.

Limits apply to $T_A = 25^\circ C$.

Symbol	Parameter	Conditions	LM4911		LM4911Q		Units (Limits)
			Typ (Note 6)	Limit (Note 7)	Typ (Note 6)	Limit (Note 7)	
I_{DD}	Quiescent Current	$V_{IN} = 0V, I_O = 0A$					
		$T_A = +25^\circ C$	1.5	3	1.5	3	mA (max)
		$T_A = -40^\circ C$ to $+105^\circ C$				4	mA (max)
I_{SD}	Shutdown Current	$V_{SHUTDOWN} = GND$	0.1	2	0.1	2	μA (max)
I_M	Mute Current	$V_{MUTE} = V_{DD}, C$ -Coupled					
		$T_A = +25^\circ C$	50	100	50	100	μA (max)
		$T_A = -40^\circ C$ to $+105^\circ C$				120	μA (max)
V_{SDIH}	Shutdown Voltage Input High	$T_A = -40^\circ C$ to $+105^\circ C$	1.8			1.8	V
V_{SDIL}	Shutdown Voltage Input Low	$T_A = -40^\circ C$ to $+105^\circ C$	0.4			0.4	V
V_{MIH}	Mute Voltage Input High	$T_A = -40^\circ C$ to $+105^\circ C$	1.8			1.8	V
V_{MIL}	Mute Voltage Input Low	$T_A = -40^\circ C$ to $+105^\circ C$	0.4			0.4	V

Symbol	Parameter	Conditions	LM4911		LM4911Q		Units (Limits)
			Typ (Note 6)	Limit (Note 7)	Typ (Note 6)	Limit (Note 7)	
P _O	Output Power	THD ≤ 1%; C-CUPL, R _L = 16Ω					
		T _A = +25°C	40		40	35	mW (min)
		T _A = -40°C to +105°C				30	mW (min)
		THD ≤ 1%, f = 1kHz, R _L = 32Ω	25				mW (min)
THD+N	Total Harmonic Distortion + Noise	P _O = 15.3mW, f = 1kHz	0.1	0.5	0.1	0.5	% (max) (Note 11)
PSRR	Power Supply Rejection Ratio	V _{RIPPLE} = 200mV sine p-p f = 1kHz (Note 9)	65		65		dB
V _{ON}	Output Noise Voltage	BW = 20 Hz to 20kHz, A-weighted	10		10		μV

Electrical Characteristics V_{DD} = 2.4V (Note 1, Note 2)

The following specifications apply for V_{DD} = 2.4V, R_L = 16Ω, and C_B = 4.7μF unless otherwise specified.

Limits apply to T_A = 25°C.

Symbol	Parameter	Conditions	LM4911		LM4911Q		Units (Limits)
			Typ (Note 6)	Limit (Note 7)	Typ (Note 6)	Limit (Note 7)	
I _{DD}	Quiescent Current	V _{IN} = 0V, I _O = 0A					
		T _A = +25°C	1.5	3	1.5	3	mA (max)
		T _A = -40°C to +105°C				4	mA (max)
I _{SD}	Shutdown Current	V _{SHUTDOWN} = GND	0.1	2	0.1	2	μA (max)
I _M	Mute Current	V _{MUTE} = V _{DD} , C-Coupled					
		T _A = +25°C	40	80	40	80	μA (max)
		T _A = -40°C to +105°C				100	μA (max)
V _{SDIH}	Shutdown Voltage Input High	T _A = -40°C to +105°C	1.8			1.8	V
V _{SDIL}	Shutdown Voltage Input Low	T _A = -40°C to +105°C	0.4			0.4	V
V _{MIH}	Mute Voltage Input High	T _A = -40°C to +105°C	1.8			1.8	V
V _{MIL}	Mute Voltage Input Low		0.4			0.4	V
P _O	Output Power	THD = 1%; C-CUPL, R _L = 16Ω					
		T _A = +25°C	25		25	20	mW (min)
		T _A = -40°C to +105°C				15	mW (min)
		THD ≤ 1%; R _L = 32Ω, f = 1kHz	12		12		
THD+N	Total Harmonic Distortion + Noise	P _O = 15.3mW, f = 1kHz	0.1	0.5	0.1	0.5	% (max) (Note 11)
T _{WU}	Wake Up Time	OCL	0.5		0.5		s
		C-Coupled, C _O = 100μF	2		2		s
T _{UM}	Un-mute Time	C-Coupled, C _O = 100μF	0.01	0.02	0.01	0.02	s (max)
V _{OSD}	Output Voltage Change on Release from Shutdown	C-Coupled, C _O = 100μF		1		1	mV (max)
PSRR	Power Supply Rejection Ratio	V _{RIPPLE} = 200mV sine p-p f = 1kHz (Note 9)	65		65		dB
V _{ON}	Output Noise Voltage	BW = 20 Hz to 20kHz, A-weighted	10		10		dB

Note 1: All voltages are measured with respect to the GND pin unless otherwise specified.

Note 2: *Absolute Maximum Ratings* indicate limits beyond which damage to the device may occur. *Operating Ratings* indicate conditions for which the device is functional but do not guarantee specific performance limits. *Electrical Characteristics* state DC and AC electrical specifications under particular test conditions which guarantee specific performance limits. This assumes that the device is within the *Operating Ratings*. Specifications are not guaranteed for parameters where no limit is given; however, the typical value is a good indication of device performance.

Note 3: The maximum power dissipation must be derated at elevated temperatures and is dictated by T_{JMAX} , θ_{JA} , and the ambient temperature, T_A . The maximum allowable power dissipation is $P_{DMAX} = (T_{JMAX} - T_A) / \theta_{JA}$ or the number given in *Absolute Maximum Ratings*, whichever is lower. For the LM4911/LM4911Q, see power derating currents for more information.

Note 4: Human body model, 100pF discharged through a 1.5k Ω resistor.

Note 5: Machine Model, 220pF-240pF discharged through all pins.

Note 6: Typical values are measured at 25°C and represent the parametric norm.

Note 7: Limits are guaranteed to National's AOQL (Average Outgoing Quality Level).

Note 8: Datasheet min/max specification limits are guaranteed by design, test, or statistical analysis.

Note 9: 10 Ω terminated input.

Note 10: The LDA10A package has its exposed-DAP soldered to an exposed 1.2in² area of 1oz. Printed circuit board copper.

Note 11: The limit is guaranteed over the temperature range of -40°C to +85°C.

External Components Description

(Figure 2)

Components		Functional Description
1.	R_i	Inverting input resistance which sets the closed-loop gain in conjunction with R_f . This resistor also forms a high-pass filter with C_i at $f_c = 1/(2\pi R_i C_i)$.
2.	C_i	Input coupling capacitor which blocks the DC voltage at the amplifier's input terminals. Also creates a high-pass filter with R_i at $f_c = 1/(2\pi R_i C_i)$. Refer to the section Proper Selection of External Components , for an explanation of how to determine the value of C_i .
3.	R_f	Feedback resistance which sets the closed-loop gain in conjunction with R_i .
4.	C_S	Supply bypass capacitor which provides power supply filtering. Refer to the Power Supply Bypassing section for information concerning proper placement and selection of the supply bypass capacitor.
5.	C_B	Bypass pin capacitor which provides half-supply filtering. Refer to the section, Proper Selection of Proper Components , for information concerning proper placement and selection of C_B .
6.	C_o	Output coupling capacitor which blocks the DC voltage at the amplifier's output. Forms a high pass filter with R_L at $f_o = 1/(2\pi R_L C_o)$.

Typical Performance Characteristics

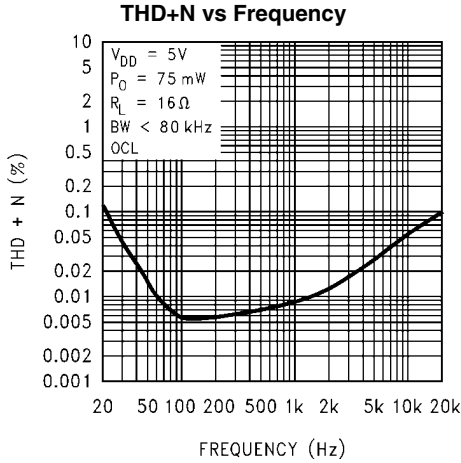

20031482

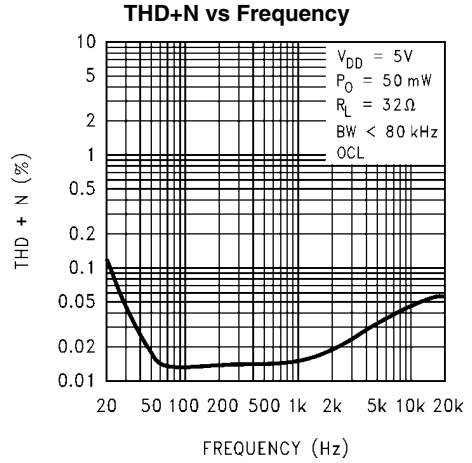

20031483

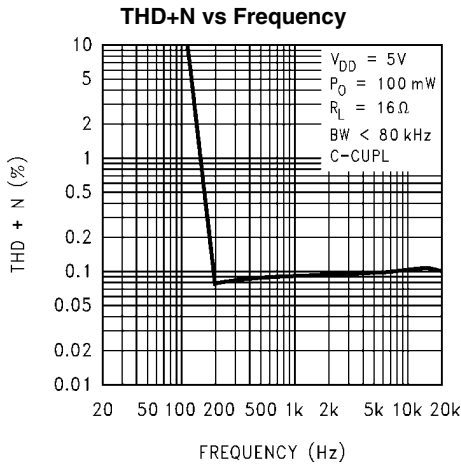

20031484

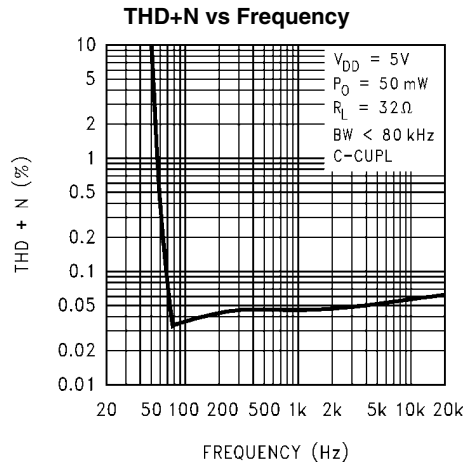

20031485

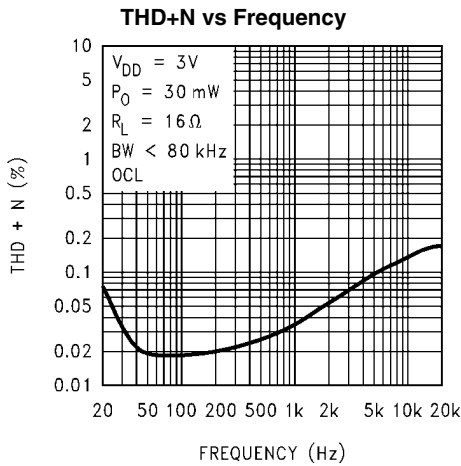

20031406

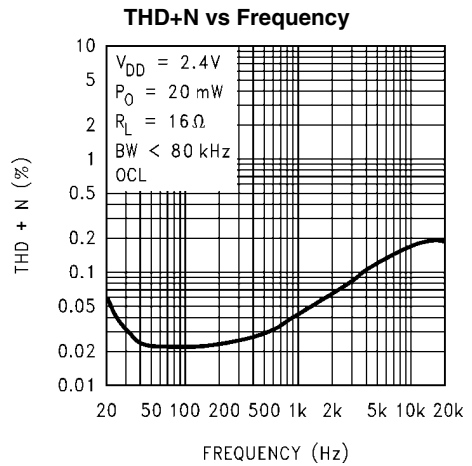

20031403

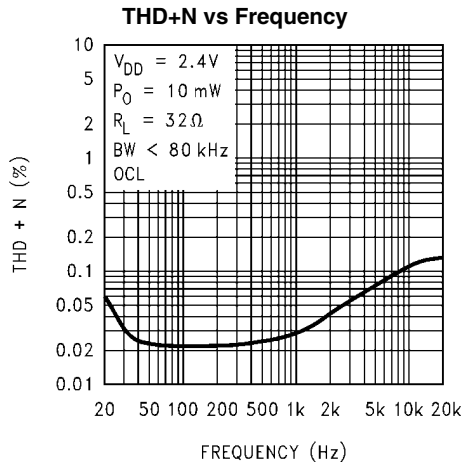

20031405

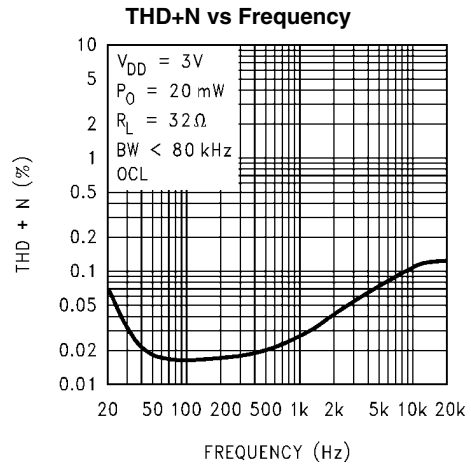

20031404

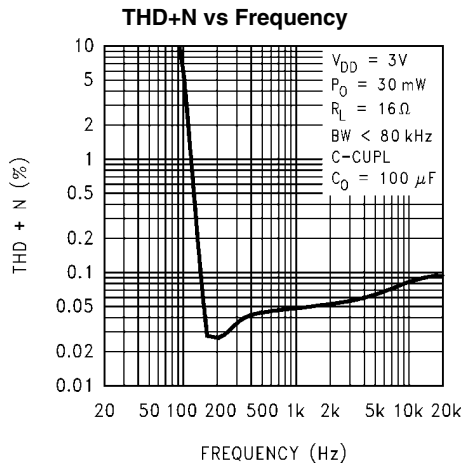

20031486

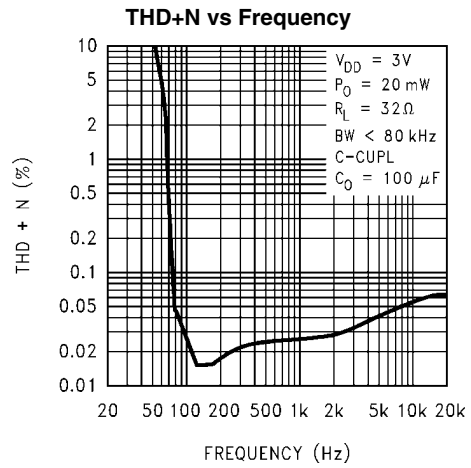

20031487

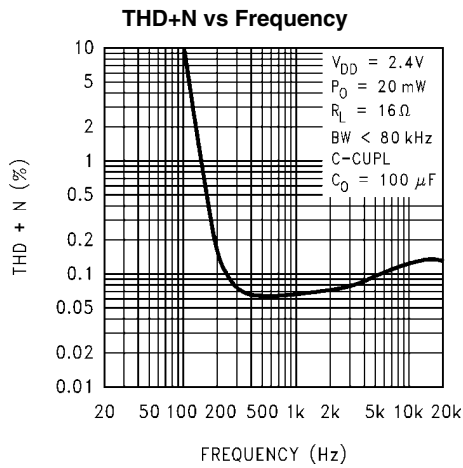

20031488

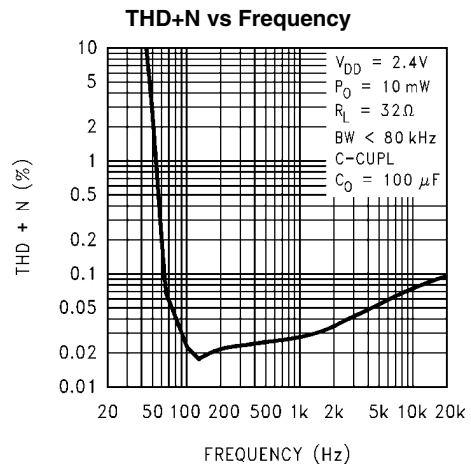

20031489

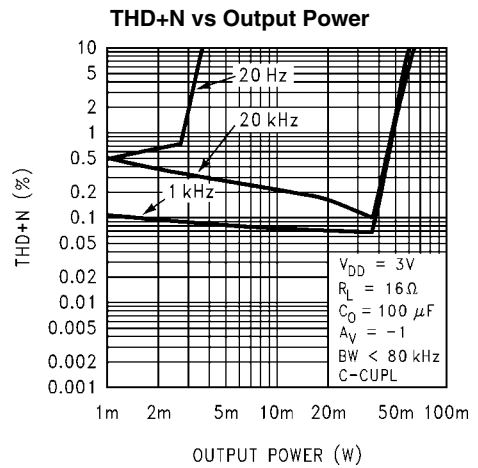
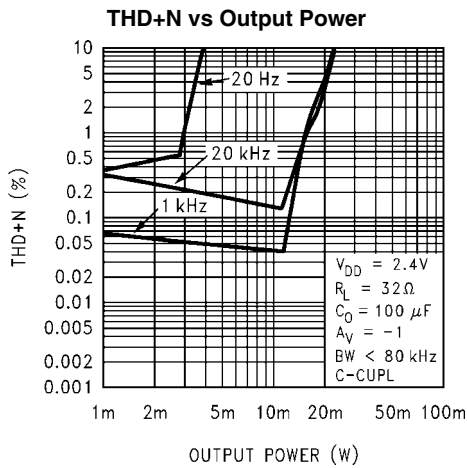
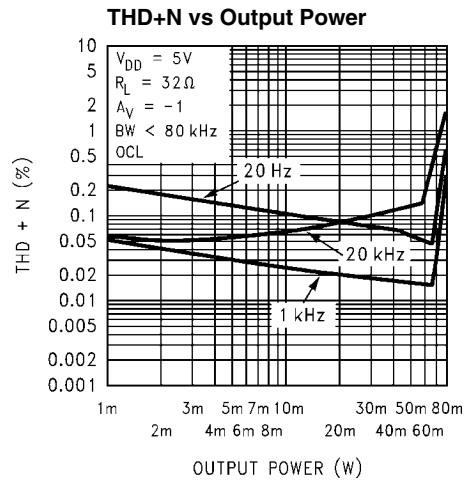
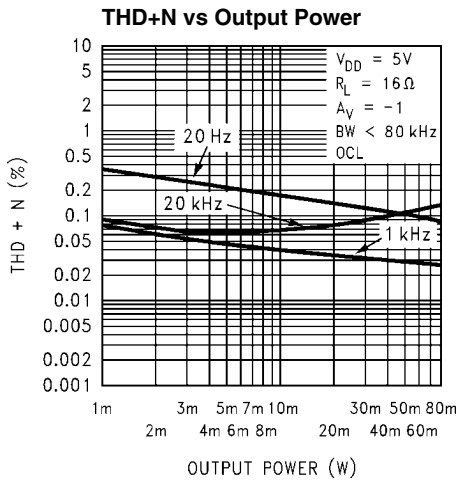
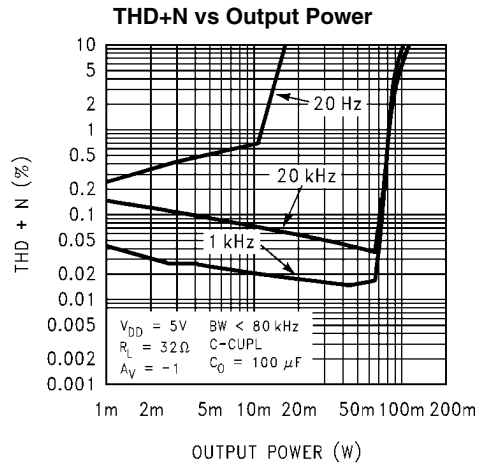
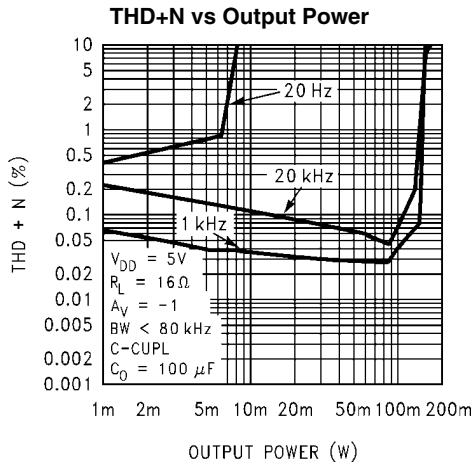

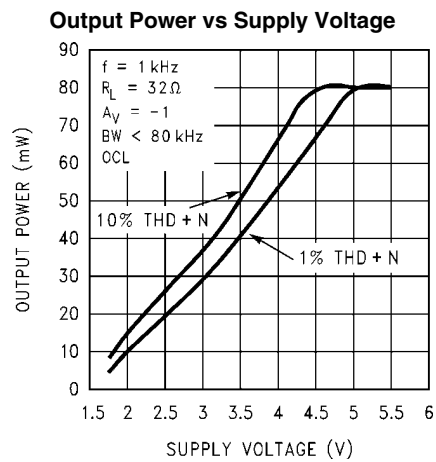
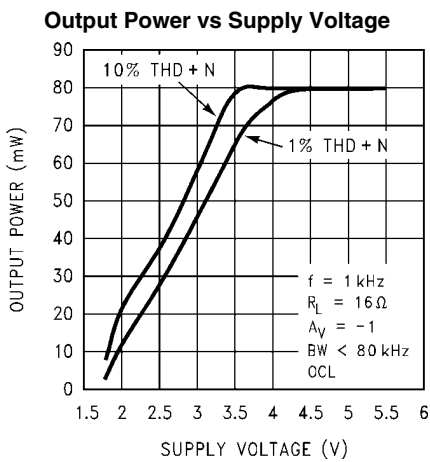
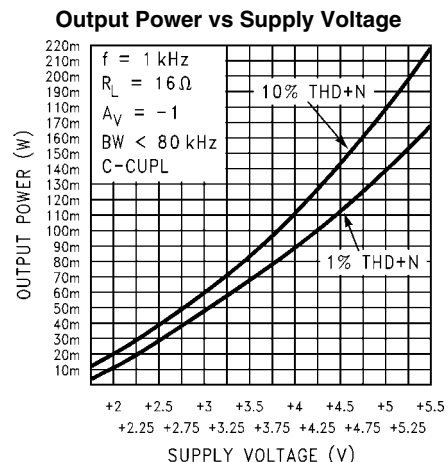
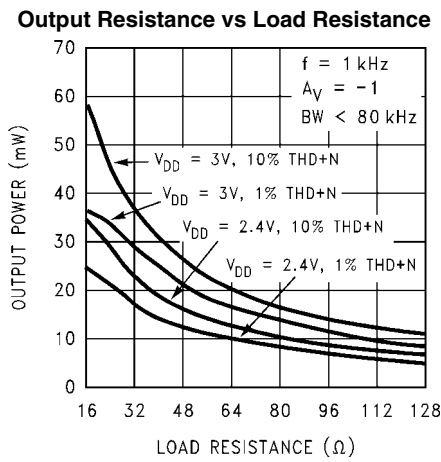
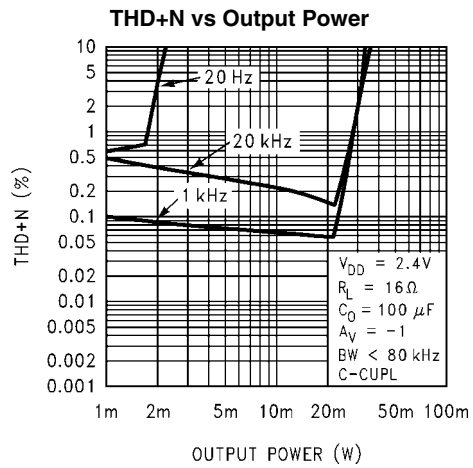
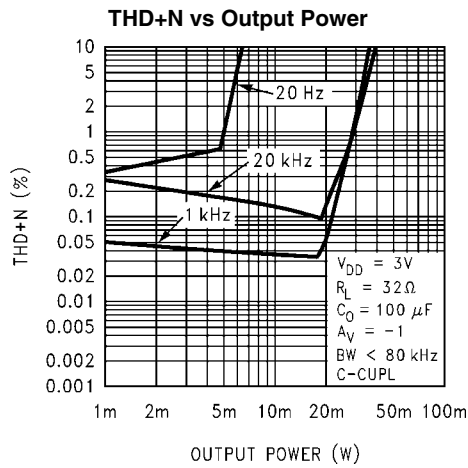

Output Power vs Supply Voltage

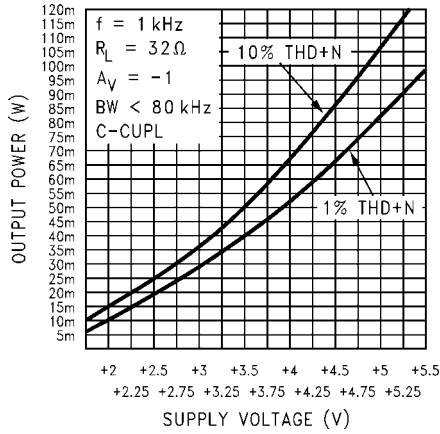

20031411

Output Power vs Load Resistance

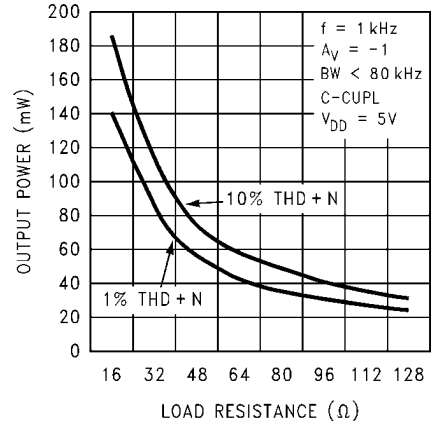

20031496

Output Power vs Load Resistance

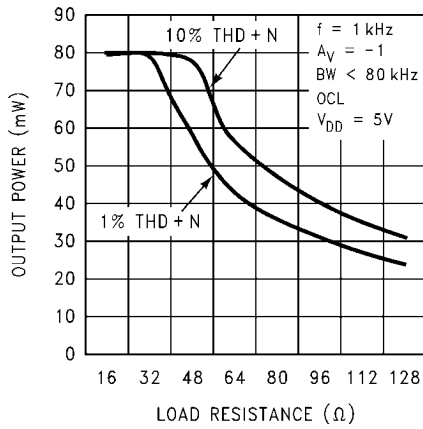

20031497

Power Dissipation vs. Output Power

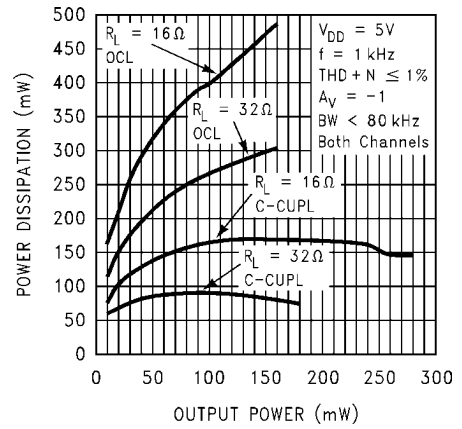

20031498

Power Dissipation vs. Output Power

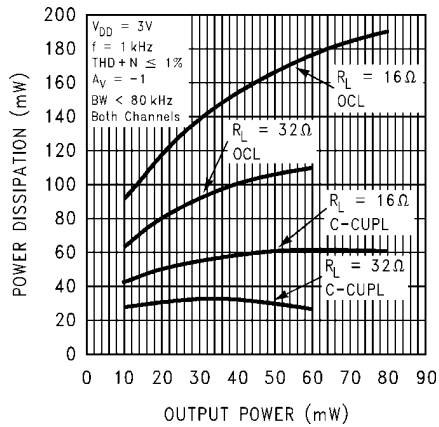

20031499

Power Dissipation vs. Output Power

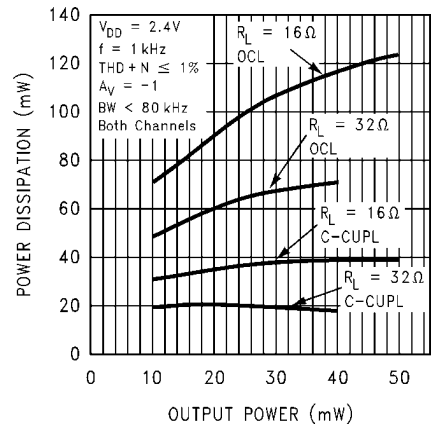

200314a0

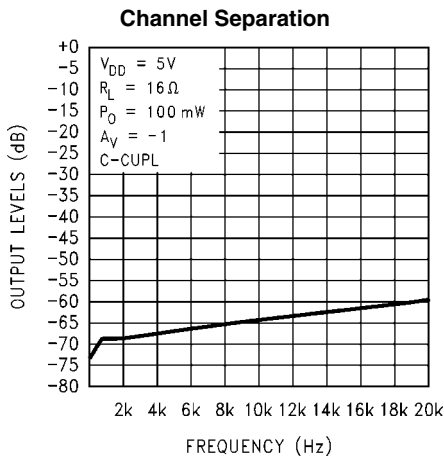

200314a1

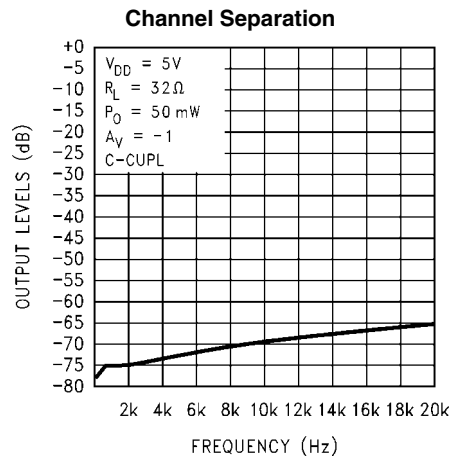

200314a2

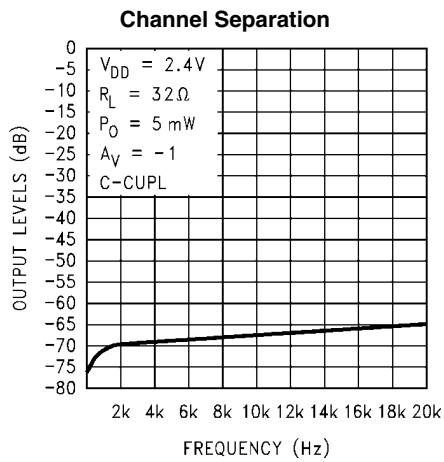

20031417

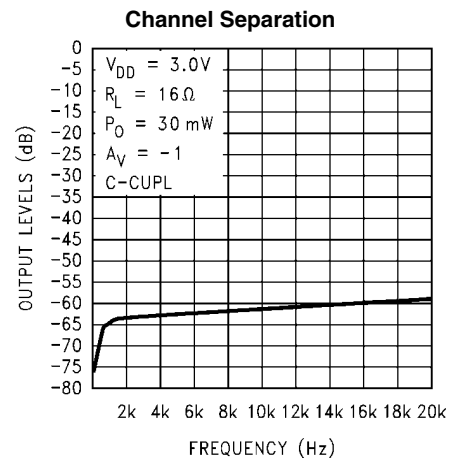

20031419

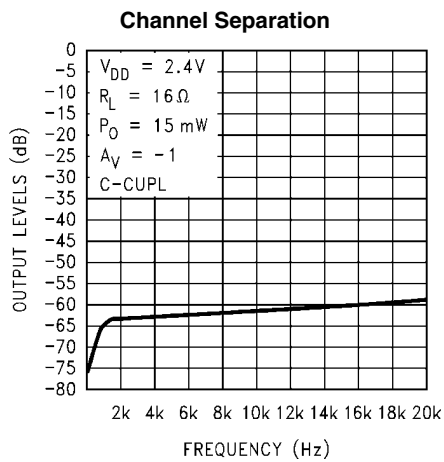

20031418

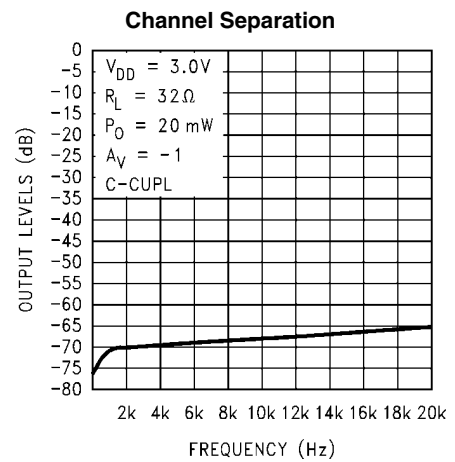

20031416

Power Supply Rejection Ratio

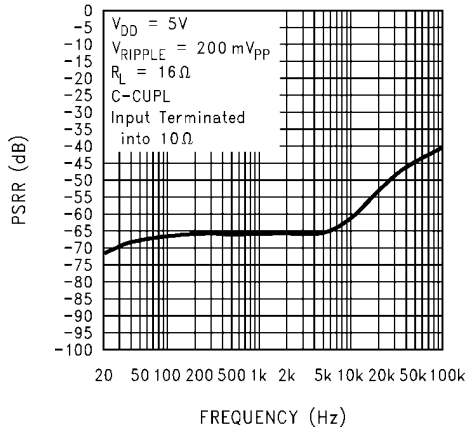

200314a3

Power Supply Rejection Ratio

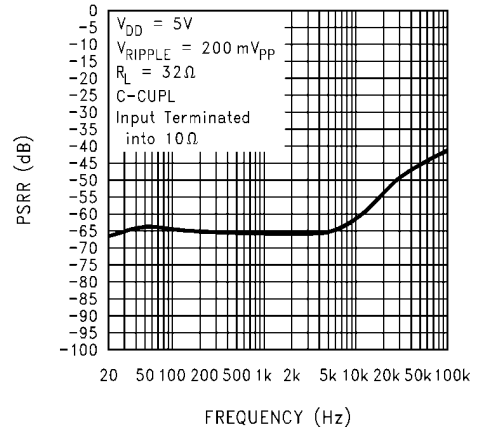

200314a4

Power Supply Rejection Ratio

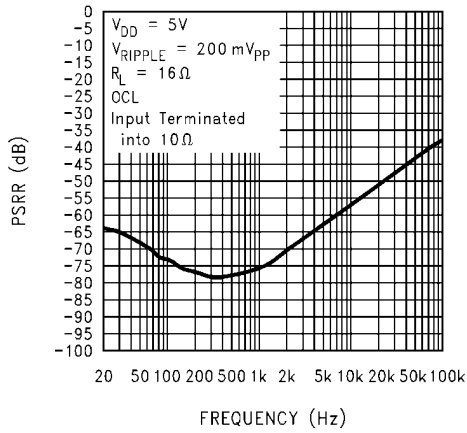

200314a5

Power Supply Rejection Ratio

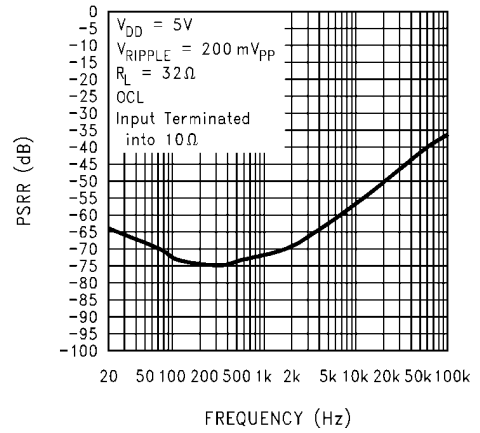

200314a6

Power Supply Rejection Ratio

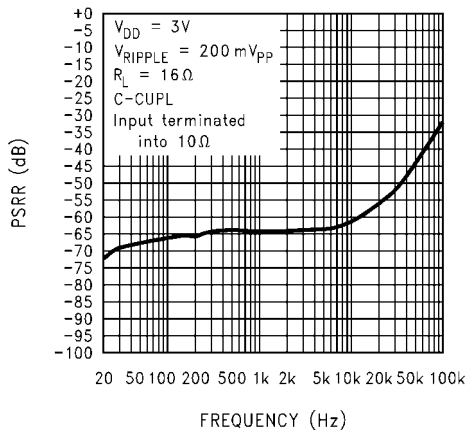

20031420

Power Supply Rejection Ratio

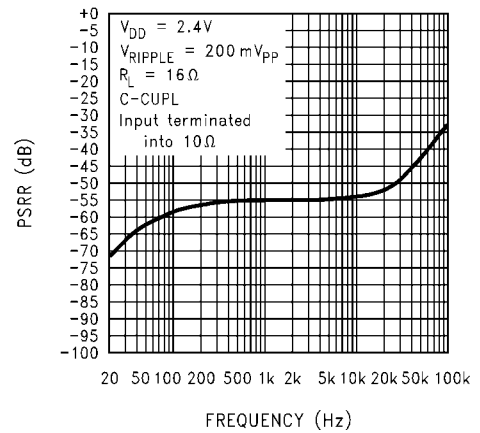

20031423

Power Supply Rejection Ratio

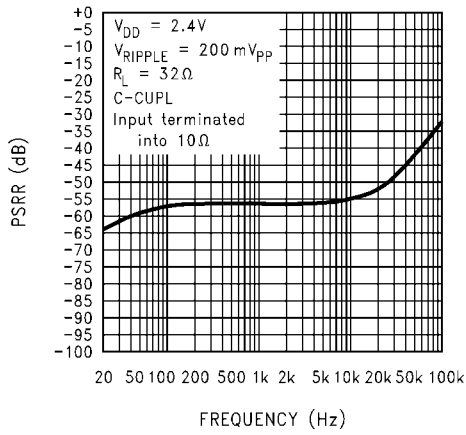

20031421

Power Supply Rejection Ratio

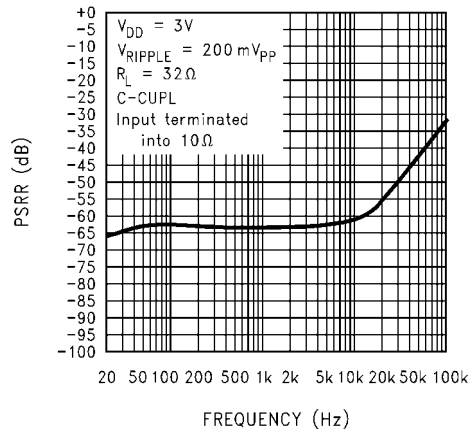

20031422

Frequency Response vs Input Capacitor Size

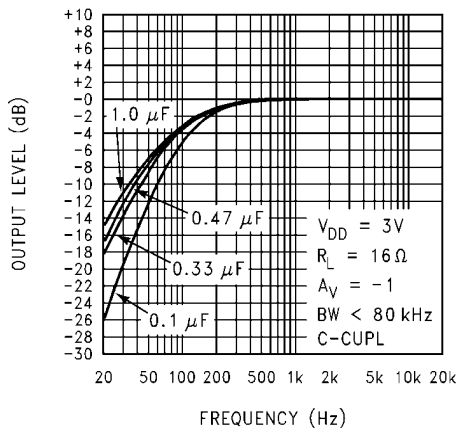

20031427

Frequency Response vs Input Capacitor Size

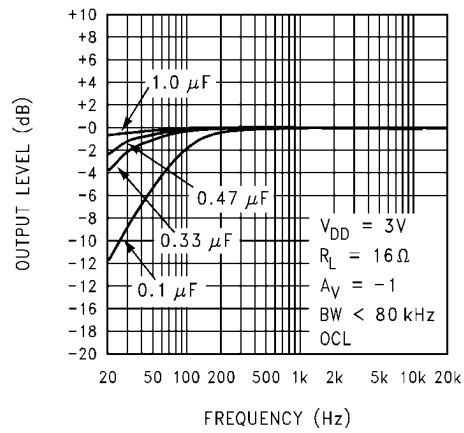

20031426

Open Loop Frequency Response

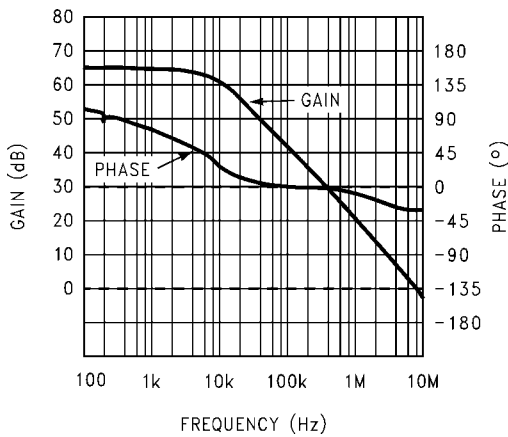

200314a7

Supply Voltage vs Supply Current

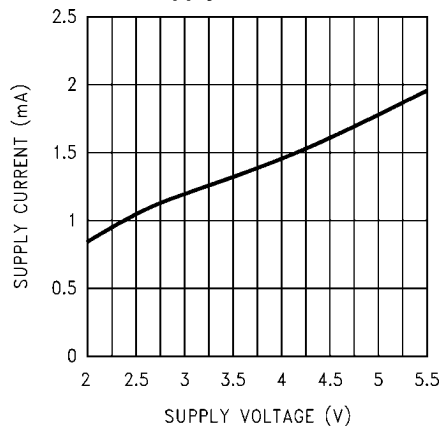

20031424

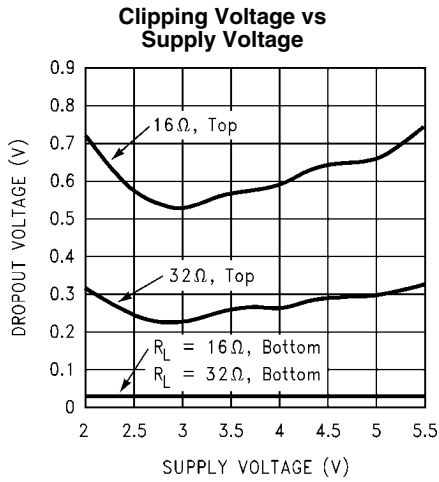

20031425

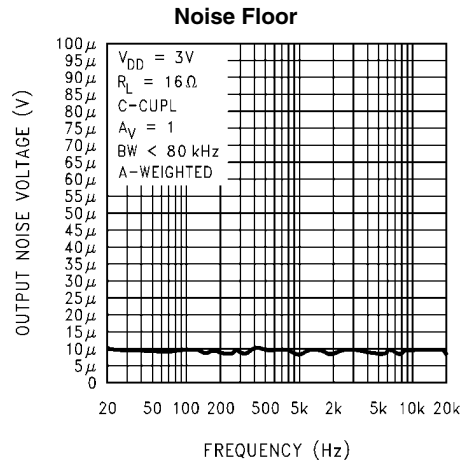

200314a8

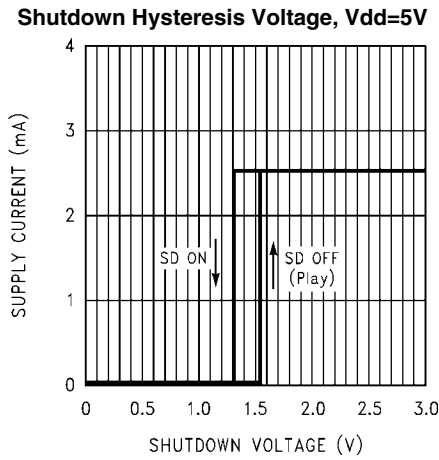

200314b1

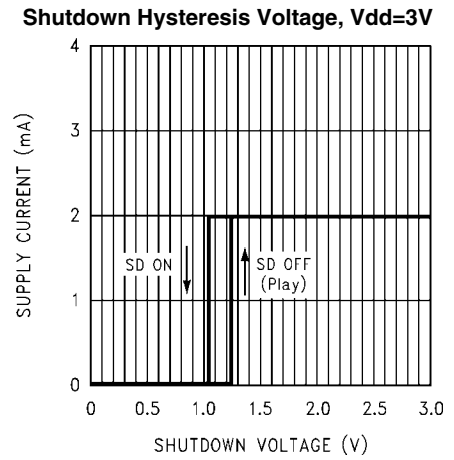

200314b2

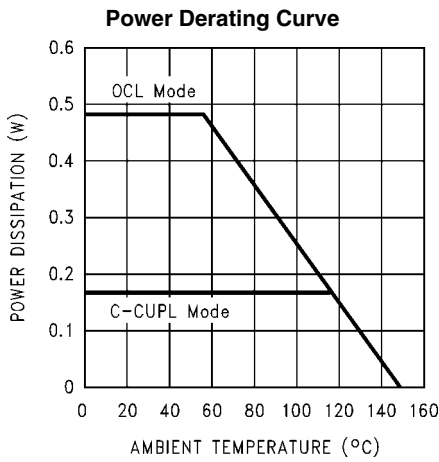

200314b3

Typical Performance Characteristics

LM4911/LM4911Q Specific Characteristics (Note 10)

THD+N vs Frequency
 at $V_{DD} = 5V$, $R_L = 16\Omega$
 $P_O = 100mW$, OCL

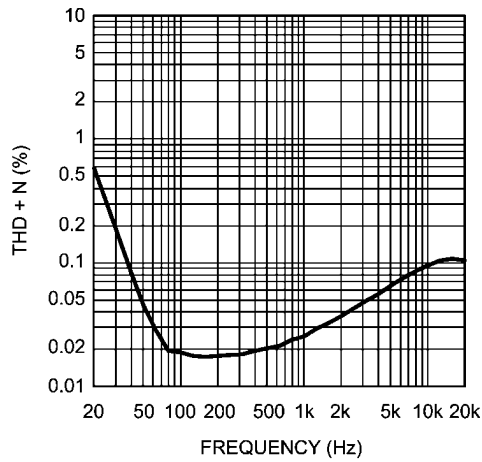

200314b7

THD+N vs Output Power
 at $V_{DD} = 5V$, $R_L = 16\Omega$, OCL

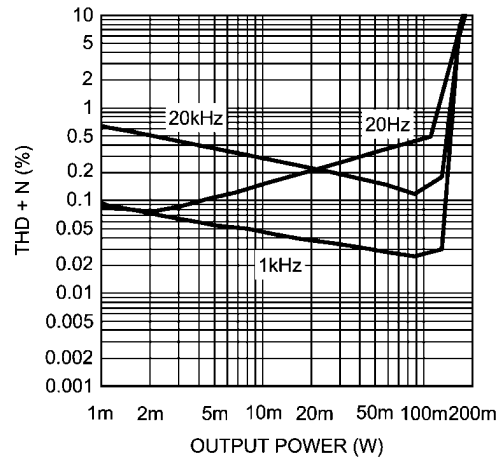

200314b8

Power Dissipation vs Output Power
 at $V_{DD} = 5V$, $R_L = 16\Omega$
 $THD+N \leq 1\%$, OCL

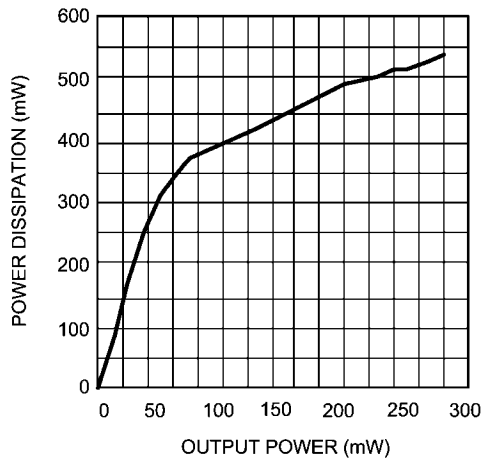

200314b9

Application Information

AMPLIFIER CONFIGURATION EXPLANATION

As shown in *Figure 1*, the LM4911/LM4911Q has three operational amplifiers internally. Two of the amplifiers have externally configurable gain while the other amplifier is internally fixed at the bias point acting as a unity-gain buffer. The closed-loop gain of the two configurable amplifiers is set by selecting the ratio of R_f to R_i . Consequently, the gain for each channel of the IC is

$$A_{VD} = -(R_f / R_i)$$

By driving the loads through outputs V_{oA} and V_{oB} with V_{oC} acting as a buffered bias voltage the LM4911/LM4911Q does not require output coupling capacitors. The classical single-ended amplifier configuration where one side of the load is connected to ground requires large, expensive output coupling capacitors.

A configuration such as the one used in the LM4911/LM4911Q has a major advantage over single supply, single-ended amplifiers. Since the outputs V_{oA} , V_{oB} , and V_{oC} are all biased at $1/2 V_{DD}$, no net DC voltage exists across each load. This eliminates the need for output coupling capacitors which are required in a single-supply, single-ended amplifier configuration. Without output coupling capacitors in a typical single-supply, single-ended amplifier, the bias voltage is placed across the load resulting in both increased internal IC power dissipation and possible loudspeaker damage.

OUTPUT CAPACITOR vs. CAPACITOR COUPLED

The LM4911/LM4911Q is a stereo audio power amplifier capable of operating in two distinct output modes: capacitor coupled (C-CUPL) or output capacitor-less (OCL). The LM4911/LM4911Q may be run in capacitor coupled mode by using a coupling capacitor on each single-ended output (V_{oA} and V_{oB}) and connecting V_{oC} to ground. This output coupling capacitor blocks the half supply voltage to which the output amplifiers are typically biased and couples the audio signal to the headphones or other single-ended (SE) load. The signal return to circuit ground is through the headphone jack's sleeve.

The LM4911/LM4911Q can also eliminate these output coupling capacitors by running in OCL mode. Unless shorted to ground, V_{oC} is internally configured to apply a $1/2 V_{DD}$ bias voltage to a stereo headphone jack's sleeve. This voltage matches the bias voltage present on V_{oA} and V_{oB} outputs that drive the headphones. The headphones operate in a manner similar to a bridge-tied load (BTL). Because the same DC voltage is applied to both headphone speaker terminals this

results in no net DC current flow through the speaker. AC current flows through a headphone speaker as an audio signal's output amplitude increases on the speaker's terminal. The headphone jack's sleeve is not connected to circuit ground when used in OCL mode. Using the headphone output jack as a line-level output will place the LM4911/LM4911Q's $1/2 V_{DD}$ bias voltage on a plug's sleeve connection. This presents no difficulty when the external equipment uses capacitively coupled inputs. For the very small minority of equipment that is DC coupled, the LM4911/LM4911Q monitors the current supplied by the amplifier that drives the headphone jack's sleeve. If this current exceeds $500mA_{PK}$, the amplifier is shutdown, protecting the LM4911/LM4911Q and the external equipment.

MODE SELECT DETAIL

The LM4911/LM4911Q may be set up to operate in one of two modes: OCL and cap-coupled. The default state of the LM4911/LM4911Q at power up is cap-coupled. During initial power up or return from shutdown, the LM4911/LM4911Q must detect the correct mode of operation (OCL or cap-coupled) by sensing the status of the V_{oC} pin. When the bias voltage of the part ramps up to 60mV (as seen on the Bypass pin), an internal comparator detects the status of V_{oC} ; and at 80mV, latches that value in place. Ramp up of the bias voltage will proceed at a different rate from this point on depending upon operating mode. OCL mode will ramp up about 11 times faster than cap-coupled. Shutdown is not a valid command during this time period (T_{WU}) and should not be enabled to ensure a proper power on reset (POR) signal. In addition, the slew rate of V_{DD} must be greater than 2.5V/ms to ensure reliable POR. Recommended power up timing is shown in *Figure 5* along with proper usage of Shutdown and Mute. The mode select circuit is suspended during C_B discharge time.

The circuit shown in *Figure 4* presents an applications solution to the problem of using different supply voltages with different turn-on times in a system with the LM4911/LM4911Q. This circuit shows the LM4911/LM4911Q with a 25-50k Ω pull-up resistor connected from the shutdown pin to V_{DD} . The shutdown pin of the LM4911/LM4911Q is also being driven by an open drain output of an external microcontroller on a separate supply. This circuit ensures that shutdown is disabled when powering up the LM4911/LM4911Q by either allowing shutdown to be high before the LM4911/LM4911Q powers on (the microcontroller powers up first) or allows shutdown to ramp up with V_{DD} (the LM4911/LM4911Q powers up first). This will ensure the LM4911/LM4911Q powers up properly and enters the correct mode of operation (cap-coupled or OCL).

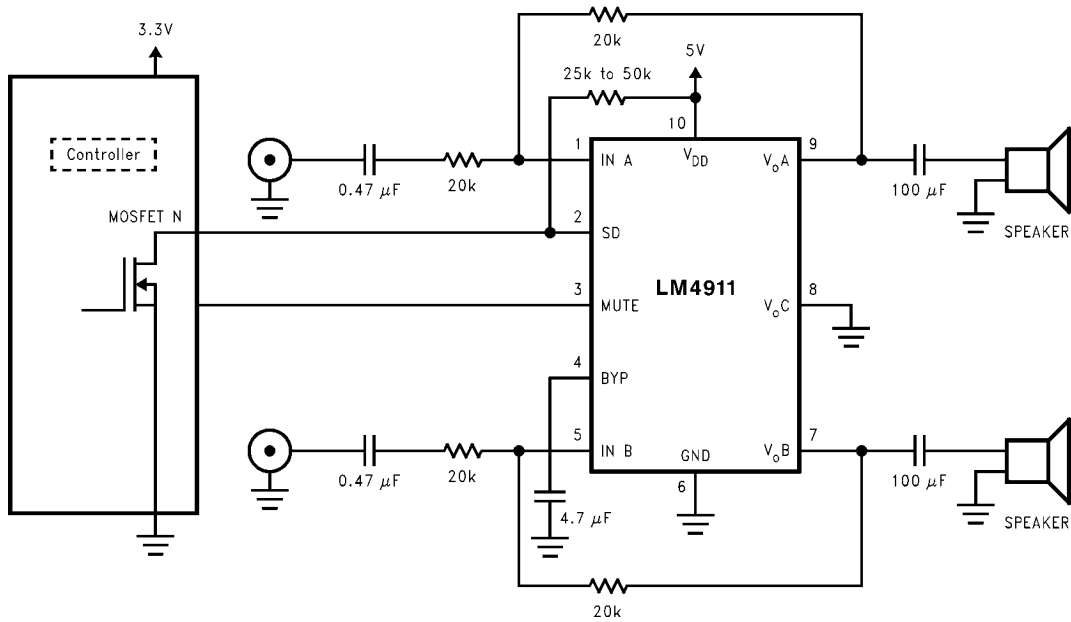

200314b6

FIGURE 4. Recommended Circuit for Different Supply Turn-On Timing

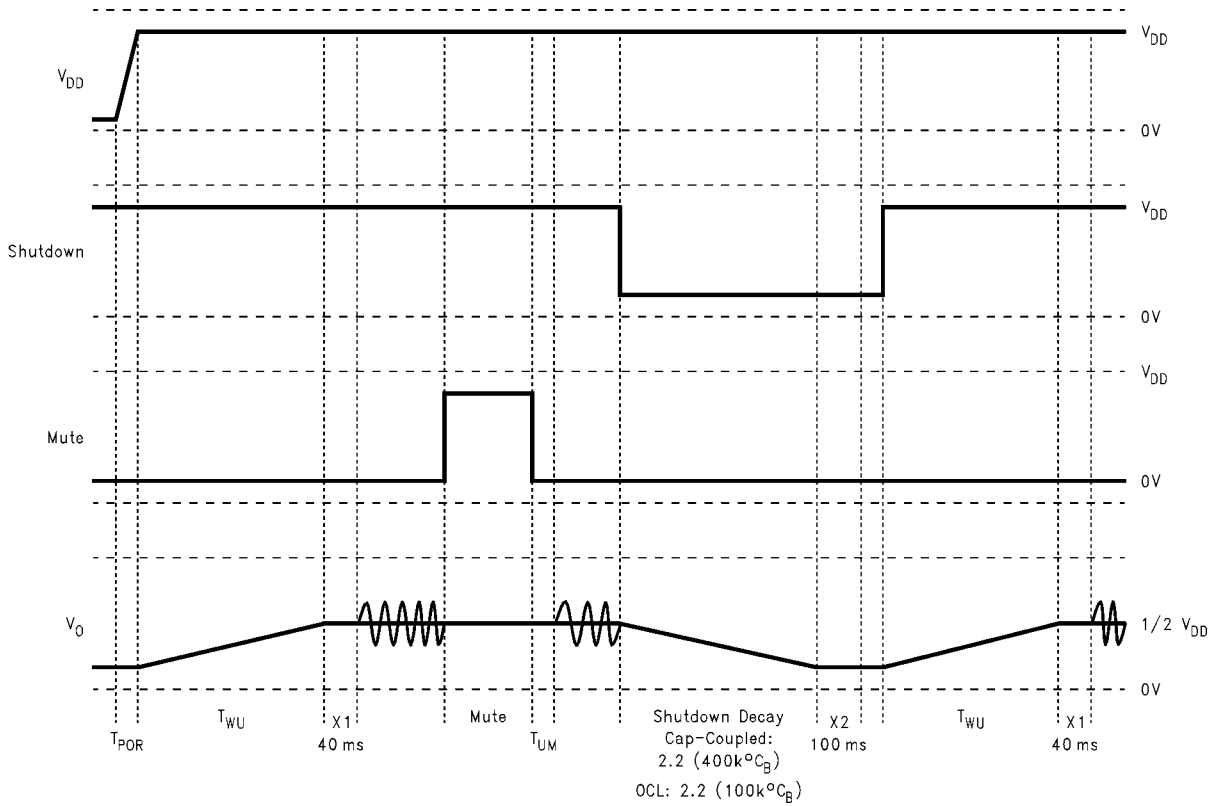

200314b5

FIGURE 5. Turn-On, Shutdown, and Mute Timing for Cap-Coupled Mode

POWER DISSIPATION

Power dissipation is a major concern when using any power amplifier and must be thoroughly understood to ensure a successful design. When operating in capacitor-coupled mode, Equation 1 states the maximum power dissipation point for a single-ended amplifier operating at a given supply voltage and driving a specified output load.

$$P_{\text{DMAX}} = (V_{\text{DD}})^2 / (2\pi^2 R_L) \quad (1)$$

Since the LM4911/LM4911Q has two operational amplifiers in one package, the maximum internal power dissipation point is twice that of the number which results from Equation 1. From Equation 1, assuming a 3V power supply and an 32Ω load, the maximum power dissipation point is 14mW per amplifier. Thus the maximum package dissipation point is 28mW.

When operating in OCL mode, the maximum power dissipation increases due to the use of the third amplifier as a buffer and is given in Equation 2:

$$P_{\text{DMAX}} = 4(V_{\text{DD}})^2 / (\pi^2 R_L) \quad (2)$$

The maximum power dissipation point obtained from either Equation 1 or 2 must not be greater than the power dissipation that results from Equation 3:

$$P_{\text{DMAX}} = (T_{\text{JMAX}} - T_A) / \theta_{\text{JA}} \quad (3)$$

For package MUB10A, $\theta_{\text{JA}} = 190^\circ\text{C/W}$; for package LDA10A, $\theta_{\text{JA}} = 63^\circ\text{C/W}$. $T_{\text{JMAX}} = 150^\circ\text{C}$ for the LM4911/LM4911Q. Depending on the ambient temperature, T_A , of the system surroundings, Equation 3 can be used to find the maximum internal power dissipation supported by the IC packaging. If the result of Equation 1 or 2 is greater than that of Equation 3, then either the supply voltage must be decreased, the load impedance increased or T_A reduced. For the typical application of a 3V power supply, with a 32Ω load, the maximum ambient temperature possible without violating the maximum junction temperature is approximately 144°C provided that device operation is around the maximum power dissipation point. Thus, for typical applications, power dissipation is not an issue. Power dissipation is a function of output power and thus, if typical operation is not around the maximum power dissipation point, the ambient temperature may be increased accordingly. Refer to the Typical Performance Characteristics curves for power dissipation information for lower output powers.

EXPOSED-DAP PACKAGE PCB MOUNTING CONSIDERATIONS

The LM4911/LM4911Q's exposed-DAP (die attach paddle) package (LD) provides a low thermal resistance between the die and the PCB to which the part is mounted and soldered. This allows rapid heat transfer from the die to the surrounding PCB copper traces, ground plane, and surrounding air.

The LD package should have its DAP soldered to a copper pad on the PCB. The DAP's PCB copper pad may be connected to a large plane of continuous unbroken copper. This plane forms a thermal mass, heat sink, and radiation area. Further detailed and specific information concerning PCB layout, fabrication, and mounting an LD (LLP) package is avail-

able from National Semiconductor's Package Engineering Group under application note AN1187.

POWER SUPPLY BYPASSING

As with any amplifier, proper supply bypassing is important for low noise performance and high power supply rejection. The capacitor location on the power supply pins should be as close to the device as possible.

Typical applications employ a 3V regulator with 10mF tantalum or electrolytic capacitor and a ceramic bypass capacitor which aid in supply stability. This does not eliminate the need for bypassing the supply nodes of the LM4911/LM4911Q. A bypass capacitor value in the range of 0.1μF to 1μF is recommended for C_S .

MICRO POWER SHUTDOWN

The voltage applied to the SHUTDOWN pin controls the LM4911/LM4911Q's shutdown function. Activate micro-power shutdown by applying a logic-low voltage to the SHUTDOWN pin. When active, the LM4911/LM4911Q's micro-power shutdown feature turns off the amplifier's bias circuitry, reducing the supply current. The trigger point varies depending on supply voltage and is shown in the Shutdown Hysteresis Voltage graphs in the Typical Performance Characteristics section. The low 0.1μA(typ) shutdown current is achieved by applying a voltage that is as near as ground as possible to the SHUTDOWN pin. A voltage that is higher than ground may increase the shutdown current. There are a few ways to control the micro-power shutdown. These include using a single-pole, single-throw switch, a microprocessor, or a microcontroller. When using a switch, connect an external 100kΩ pull-up resistor between the SHUTDOWN pin and V_{DD} . Connect the switch between the SHUTDOWN pin and ground. Select normal amplifier operation by opening the switch. Closing the switch connects the SHUTDOWN pin to ground, activating micro-power shutdown.

The switch and resistor guarantee that the SHUTDOWN pin will not float. This prevents unwanted state changes. In a system with a microprocessor or microcontroller, use a digital output to apply the control voltage to the SHUTDOWN pin. Driving the SHUTDOWN pin with active circuitry eliminates the pull-up resistor.

Shutdown enable/disable times are controlled by a combination of C_B and V_{DD} . Larger values of C_B results in longer turn on/off times from Shutdown. Smaller V_{DD} values also increase turn on/off time for a given value of C_B . Longer shutdown times also improve the LM4911/LM4911Q's resistance to click and pop upon entering or returning from shutdown. For a 2.4V supply and $C_B = 4.7\mu\text{F}$, the LM4911/LM4911Q requires about 2 seconds to enter or return from shutdown. This longer shutdown time enables the LM4911/LM4911Q to have virtually zero pop and click transients upon entering or release from shutdown.

Smaller values of C_B will decrease turn-on time, but at the cost of increased pop and click and reduced PSRR. Since shutdown enable/disable times increase dramatically as supply voltage gets below 2.2V, this reduced turn-on time may be desirable if extreme low supply voltage levels are used as this would offset increases in turn-on time caused by the lower supply voltage. This technique is not recommended for OCL mode since shutdown enable/disable times are very fast (0.5s) independent of supply voltage.

When in cap-coupled mode, some restrictions on the usage of Mute are in effect when entering or returning from shutdown. These restrictions require Mute not be toggled immediately following a return or entrance to shutdown for a brief

period. These periods are shown as X1 and X2 and are discussed in greater detail in the **Mute** section as well as shown in *Figure 5*.

MUTE

When in C-CUPL mode, the LM4911/LM4911Q also features a mute function that enables extremely fast turn-on/turn-off with a minimum of output pop and click with a low current consumption ($\leq 100\mu\text{A}$). The mute function leaves the outputs at their bias level, thus resulting in higher power consumption than shutdown mode, but also provides much faster turn on/off times. Mute mode is enabled by providing a logic high signal on the MUTE pin in the opposite manner as the shutdown function described above. Threshold voltages and activation techniques match those given for the shutdown function as well.

Mute may not appear to function when the LM4911/LM4911Q is used to drive high impedance loads. This is because the LM4911/LM4911Q relies on a typical headphone load ($16\text{-}32\Omega$) to reduce input signal feedthrough through the input and feedback resistors. Mute attenuation can thus be calculated by the following formula:

$$\text{Mute Attenuation (dB)} = 20\text{Log}(R_L / (R_i + R_F))$$

Parallel load resistance may be necessary to achieve satisfactory Mute levels when the application load is known to be high impedance.

The mute function is not necessary when the LM4911/LM4911Q is operating in OCL mode since the shutdown function operates quickly in OCL mode with less power consumption than mute.

Mute may be enabled during shutdown transitions, but should not be toggled for a brief period immediately after exiting or entering shutdown. These brief time periods are labeled X1 (time after returning from shutdown) and X2 (time after entering shutdown) and are shown in the timing diagram given in *Figure 5*. X1 occurs immediately following a return from shutdown (T_{WU}) and lasts $40\text{ms}\pm 25\%$. X2 occurs after the part is placed in shutdown and the decay of the bias voltage has occurred ($2.2*400k*C_B$ for cap-coupled and $2.2*100k*C_B$ for OCL) and lasts for $100\text{ms}\pm 25\%$. The timing of these transition periods relative to X1 and X2 is also shown in *Figure 5*. Mute should not be toggled during these time periods, but may be made during the shutdown transitions or any other time the part is in normal operation (while in cap-coupled mode - Mute is not valid in OCL mode). Failure to operate mute correctly may result in much higher click and pop values or failure of the device to mute at all.

PROPER SELECTION OF EXTERNAL COMPONENTS

Proper selection of external components in applications using integrated power amplifiers is critical to optimize device and system performance. While the LM4911/LM4911Q is tolerant of external component combinations, consideration to component values must be used to maximize overall system quality.

The LM4911/LM4911Q is unity-gain stable which gives the designer maximum system flexibility. The LM4911/LM4911Q should be used in low gain configurations to minimize THD+N values, and maximize the signal to noise ratio. Low gain configurations require large input signals to obtain a given output power. Input signals equal to or greater than $1V_{\text{rms}}$ are available from sources such as audio codecs. Very large values should not be used for the gain-setting resistors. Values for R_i and R_f should be less than $1M\Omega$. Please refer to the section,

Audio Power Amplifier Design, for a more complete explanation of proper gain selection

Besides gain, one of the major considerations is the closed-loop bandwidth of the amplifier. To a large extent, the bandwidth is dictated by the choice of external components shown in *Figure 2* and *Figure 3*. The input coupling capacitor, C_i , forms a first order high pass filter which limits low frequency response. This value should be chosen based on needed frequency response and turn-on time.

SELECTION OF INPUT CAPACITOR SIZE

Amplifying the lowest audio frequencies requires a high value input coupling capacitor, C_i . A high value capacitor can be expensive and may compromise space efficiency in portable designs. In many cases, however, the headphones used in portable systems have little ability to reproduce signals below 60Hz. Applications using headphones with this limited frequency response reap little improvement by using a high value input capacitor.

In addition to system cost and size, turn on time is affected by the size of the input coupling capacitor C_i . A larger input coupling capacitor requires more charge to reach its quiescent DC voltage. This charge comes from the output via the feedback. Thus, by minimizing the capacitor size based on necessary low frequency response, turn-on time can be minimized. A small value of C_i (in the range of $0.1\mu\text{F}$ to $0.39\mu\text{F}$), is recommended.

AUDIO POWER AMPLIFIER DESIGN

A 25mW/32Ω AUDIO AMPLIFIER

Given:

Power Output	25mWrms
Load Impedance	32Ω
Input Level	1Vrms
Input Impedance	20kΩ

A designer must first determine the minimum supply rail to obtain the specified output power. By extrapolating from the Output Power vs Supply Voltage graphs in the **Typical Performance Characteristics** section, the supply rail can be easily found.

3V is a standard voltage in most applications, it is chosen for the supply rail. Extra supply voltage creates headroom that allows the LM4911/LM4911Q to reproduce peak in excess of 25mW without producing audible distortion. At this time, the designer must make sure that the power supply choice along with the output impedance does not violate the conditions explained in the **Power Dissipation** section.

Once the power dissipation equations have been addressed, the required gain can be determined from Equation 2.

$$A_V \geq \sqrt{(P_O R_L)} / (V_{IN}) = V_{\text{orms}} / V_{\text{inrms}} \quad (4)$$

From Equation 4, the minimum A_V is 0.89; use $A_V = 1$. Since the desired input impedance is $20k\Omega$, and with a A_V gain of 1, a ratio of 1:1 results from Equation 1 for R_f to R_i . The values are chosen with $R_f = 20k\Omega$ and $R_i = 20k\Omega$. The final design step is to address the bandwidth requirements which must be stated as a pair of -3dB frequency points. Five times away from a -3dB point is 0.17dB down from passband response which is better than the required $\pm 0.25\text{dB}$ specified.

$$f_L = 100\text{Hz}/5 = 20\text{Hz}$$

$$f_H = 20\text{kHz} * 5 = 100\text{kHz}$$

As stated in the **External Components** section, R_i in conjunction with C_i creates a

$$C_i \geq 1 / (2\pi * 20\text{k}\Omega * 20\text{Hz}) = 0.397\mu\text{F}; \text{ use } 0.39\mu\text{F}.$$

The high frequency pole is determined by the product of the desired frequency pole, f_H , and the differential gain, A_v . With an $A_v = 1$ and $f_H = 100\text{kHz}$, the resulting GBWP = 100kHz which is much smaller than the LM4911/LM4911Q GBWP of 10MHz. This figure displays that is a designer has a need to design an amplifier with higher differential gain, the LM4911/LM4911Q can still be used without running into bandwidth limitations.

Figure 4 shows an optional resistor connected between the amplifier output that drives the headphone jack sleeve and ground. This resistor provides a ground path that suppressed

power supply hum. This hum may occur in applications such as notebook computers in a shutdown condition and connected to an external powered speaker. The resistor's 100 Ω value is a suggested starting point. Its final value must be determined based on the tradeoff between the amount of noise suppression that may be needed and minimizing the additional current drawn by the resistor (25mA for a 100 Ω resistor and a 5V supply).

ESD PROTECTION

As stated in the Absolute Maximum Ratings, the LM4911/LM4911Q has a maximum ESD susceptibility rating of 2000V. For higher ESD voltages, the addition of a PCDN042 dual transil (from California Micro Devices), as shown in Figure 6, will provide additional protection.

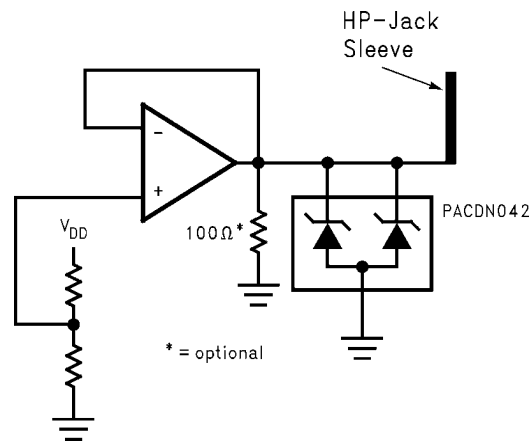

200314b4

FIGURE 6. The PCDN042 provides additional ESD protection beyond the 2000V shown in the Absolute Maximum Ratings for the V_{OC} output

Physical Dimensions inches (millimeters) unless otherwise noted

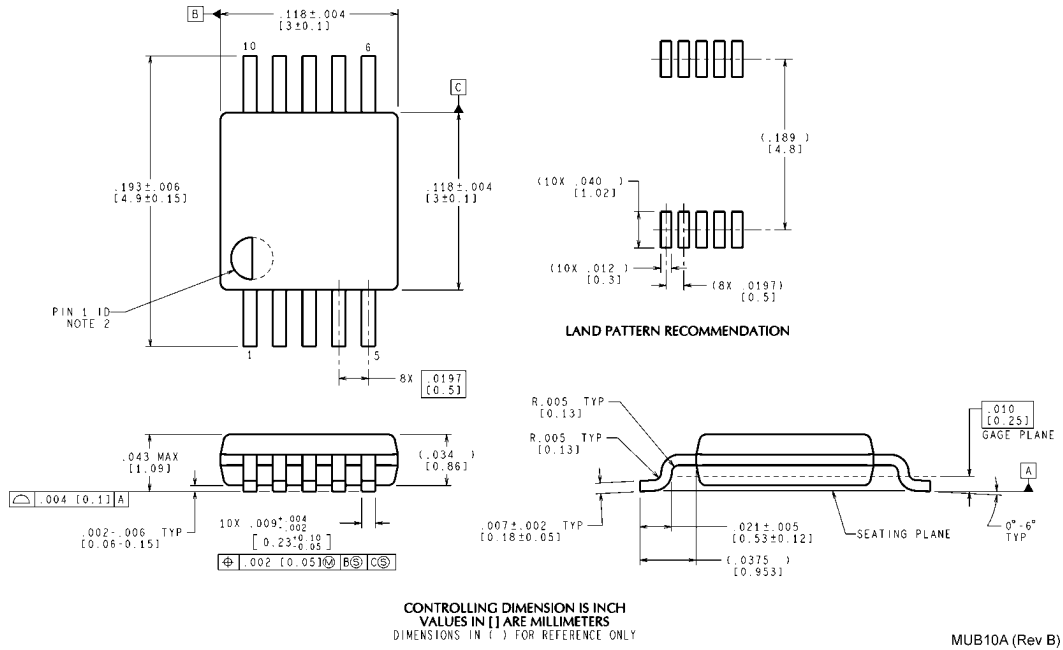

MSOP
Order Number LM4911/LM4911QMM
NS Package Number MUB10A

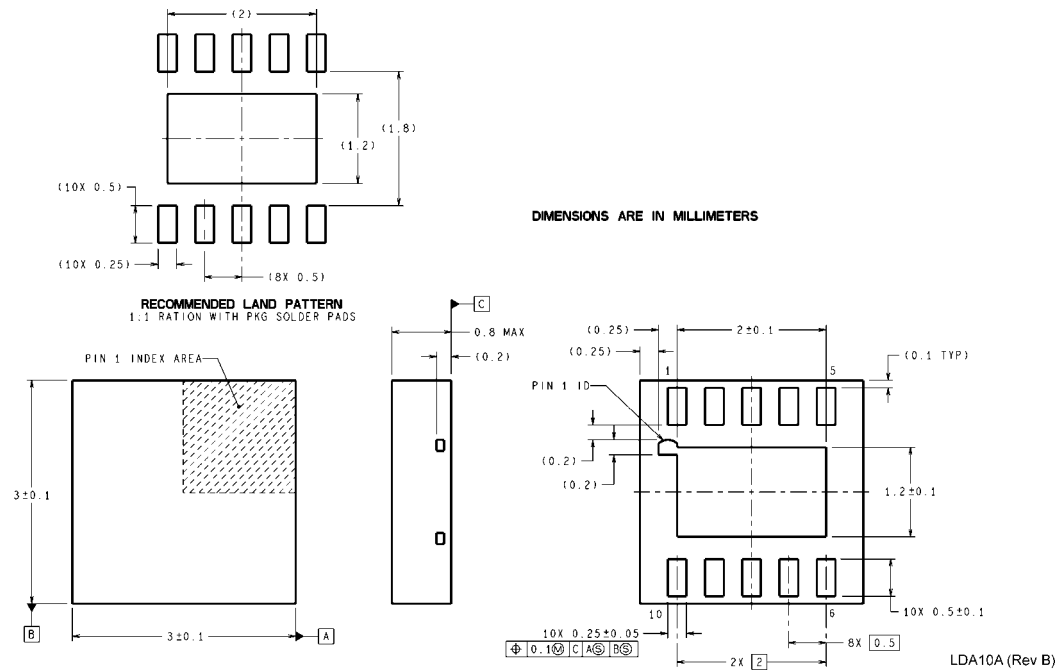

LLP
Order Number LM4911
NS Package Number LDA10A

Notes

For more National Semiconductor product information and proven design tools, visit the following Web sites at:
www.national.com

Products		Design Support	
Amplifiers	www.national.com/amplifiers	WEBENCH® Tools	www.national.com/webench
Audio	www.national.com/audio	App Notes	www.national.com/appnotes
Clock and Timing	www.national.com/timing	Reference Designs	www.national.com/refdesigns
Data Converters	www.national.com/adc	Samples	www.national.com/samples
Interface	www.national.com/interface	Eval Boards	www.national.com/evalboards
LVDS	www.national.com/lvds	Packaging	www.national.com/packaging
Power Management	www.national.com/power	Green Compliance	www.national.com/quality/green
Switching Regulators	www.national.com/switchers	Distributors	www.national.com/contacts
LDOs	www.national.com/ldo	Quality and Reliability	www.national.com/quality
LED Lighting	www.national.com/led	Feedback/Support	www.national.com/feedback
Voltage References	www.national.com/vref	Design Made Easy	www.national.com/easy
PowerWise® Solutions	www.national.com/powerwise	Applications & Markets	www.national.com/solutions
Serial Digital Interface (SDI)	www.national.com/sdi	Mil/Aero	www.national.com/milaero
Temperature Sensors	www.national.com/tempensors	SolarMagic™	www.national.com/solarmagic
PLL/VCO	www.national.com/wireless	PowerWise® Design University	www.national.com/training

THE CONTENTS OF THIS DOCUMENT ARE PROVIDED IN CONNECTION WITH NATIONAL SEMICONDUCTOR CORPORATION ("NATIONAL") PRODUCTS. NATIONAL MAKES NO REPRESENTATIONS OR WARRANTIES WITH RESPECT TO THE ACCURACY OR COMPLETENESS OF THE CONTENTS OF THIS PUBLICATION AND RESERVES THE RIGHT TO MAKE CHANGES TO SPECIFICATIONS AND PRODUCT DESCRIPTIONS AT ANY TIME WITHOUT NOTICE. NO LICENSE, WHETHER EXPRESS, IMPLIED, ARISING BY ESTOPPEL OR OTHERWISE, TO ANY INTELLECTUAL PROPERTY RIGHTS IS GRANTED BY THIS DOCUMENT.

TESTING AND OTHER QUALITY CONTROLS ARE USED TO THE EXTENT NATIONAL DEEMS NECESSARY TO SUPPORT NATIONAL'S PRODUCT WARRANTY. EXCEPT WHERE MANDATED BY GOVERNMENT REQUIREMENTS, TESTING OF ALL PARAMETERS OF EACH PRODUCT IS NOT NECESSARILY PERFORMED. NATIONAL ASSUMES NO LIABILITY FOR APPLICATIONS ASSISTANCE OR BUYER PRODUCT DESIGN. BUYERS ARE RESPONSIBLE FOR THEIR PRODUCTS AND APPLICATIONS USING NATIONAL COMPONENTS. PRIOR TO USING OR DISTRIBUTING ANY PRODUCTS THAT INCLUDE NATIONAL COMPONENTS, BUYERS SHOULD PROVIDE ADEQUATE DESIGN, TESTING AND OPERATING SAFEGUARDS.

EXCEPT AS PROVIDED IN NATIONAL'S TERMS AND CONDITIONS OF SALE FOR SUCH PRODUCTS, NATIONAL ASSUMES NO LIABILITY WHATSOEVER, AND NATIONAL DISCLAIMS ANY EXPRESS OR IMPLIED WARRANTY RELATING TO THE SALE AND/OR USE OF NATIONAL PRODUCTS INCLUDING LIABILITY OR WARRANTIES RELATING TO FITNESS FOR A PARTICULAR PURPOSE, MERCHANTABILITY, OR INFRINGEMENT OF ANY PATENT, COPYRIGHT OR OTHER INTELLECTUAL PROPERTY RIGHT.

LIFE SUPPORT POLICY

NATIONAL'S PRODUCTS ARE NOT AUTHORIZED FOR USE AS CRITICAL COMPONENTS IN LIFE SUPPORT DEVICES OR SYSTEMS WITHOUT THE EXPRESS PRIOR WRITTEN APPROVAL OF THE CHIEF EXECUTIVE OFFICER AND GENERAL COUNSEL OF NATIONAL SEMICONDUCTOR CORPORATION. As used herein:

Life support devices or systems are devices which (a) are intended for surgical implant into the body, or (b) support or sustain life and whose failure to perform when properly used in accordance with instructions for use provided in the labeling can be reasonably expected to result in a significant injury to the user. A critical component is any component in a life support device or system whose failure to perform can be reasonably expected to cause the failure of the life support device or system or to affect its safety or effectiveness.

National Semiconductor and the National Semiconductor logo are registered trademarks of National Semiconductor Corporation. All other brand or product names may be trademarks or registered trademarks of their respective holders.

Copyright© 2011 National Semiconductor Corporation

For the most current product information visit us at www.national.com



National Semiconductor Americas Technical Support Center
 Email: support@nsc.com
 Tel: 1-800-272-9959

National Semiconductor Europe Technical Support Center
 Email: europe.support@nsc.com

National Semiconductor Asia Pacific Technical Support Center
 Email: ap.support@nsc.com

National Semiconductor Japan Technical Support Center
 Email: jpn.feedback@nsc.com

IMPORTANT NOTICE

Texas Instruments Incorporated and its subsidiaries (TI) reserve the right to make corrections, modifications, enhancements, improvements, and other changes to its products and services at any time and to discontinue any product or service without notice. Customers should obtain the latest relevant information before placing orders and should verify that such information is current and complete. All products are sold subject to TI's terms and conditions of sale supplied at the time of order acknowledgment.

TI warrants performance of its hardware products to the specifications applicable at the time of sale in accordance with TI's standard warranty. Testing and other quality control techniques are used to the extent TI deems necessary to support this warranty. Except where mandated by government requirements, testing of all parameters of each product is not necessarily performed.

TI assumes no liability for applications assistance or customer product design. Customers are responsible for their products and applications using TI components. To minimize the risks associated with customer products and applications, customers should provide adequate design and operating safeguards.

TI does not warrant or represent that any license, either express or implied, is granted under any TI patent right, copyright, mask work right, or other TI intellectual property right relating to any combination, machine, or process in which TI products or services are used. Information published by TI regarding third-party products or services does not constitute a license from TI to use such products or services or a warranty or endorsement thereof. Use of such information may require a license from a third party under the patents or other intellectual property of the third party, or a license from TI under the patents or other intellectual property of TI.

Reproduction of TI information in TI data books or data sheets is permissible only if reproduction is without alteration and is accompanied by all associated warranties, conditions, limitations, and notices. Reproduction of this information with alteration is an unfair and deceptive business practice. TI is not responsible or liable for such altered documentation. Information of third parties may be subject to additional restrictions.

Resale of TI products or services with statements different from or beyond the parameters stated by TI for that product or service voids all express and any implied warranties for the associated TI product or service and is an unfair and deceptive business practice. TI is not responsible or liable for any such statements.

TI products are not authorized for use in safety-critical applications (such as life support) where a failure of the TI product would reasonably be expected to cause severe personal injury or death, unless officers of the parties have executed an agreement specifically governing such use. Buyers represent that they have all necessary expertise in the safety and regulatory ramifications of their applications, and acknowledge and agree that they are solely responsible for all legal, regulatory and safety-related requirements concerning their products and any use of TI products in such safety-critical applications, notwithstanding any applications-related information or support that may be provided by TI. Further, Buyers must fully indemnify TI and its representatives against any damages arising out of the use of TI products in such safety-critical applications.

TI products are neither designed nor intended for use in military/aerospace applications or environments unless the TI products are specifically designated by TI as military-grade or "enhanced plastic." Only products designated by TI as military-grade meet military specifications. Buyers acknowledge and agree that any such use of TI products which TI has not designated as military-grade is solely at the Buyer's risk, and that they are solely responsible for compliance with all legal and regulatory requirements in connection with such use.

TI products are neither designed nor intended for use in automotive applications or environments unless the specific TI products are designated by TI as compliant with ISO/TS 16949 requirements. Buyers acknowledge and agree that, if they use any non-designated products in automotive applications, TI will not be responsible for any failure to meet such requirements.

Following are URLs where you can obtain information on other Texas Instruments products and application solutions:

Products

Audio	www.ti.com/audio
Amplifiers	amplifier.ti.com
Data Converters	dataconverter.ti.com
DLP® Products	www.dlp.com
DSP	dsp.ti.com
Clocks and Timers	www.ti.com/clocks
Interface	interface.ti.com
Logic	logic.ti.com
Power Mgmt	power.ti.com
Microcontrollers	microcontroller.ti.com
RFID	www.ti-rfid.com
OMAP Mobile Processors	www.ti.com/omap
Wireless Connectivity	www.ti.com/wirelessconnectivity

Applications

Communications and Telecom	www.ti.com/communications
Computers and Peripherals	www.ti.com/computers
Consumer Electronics	www.ti.com/consumer-apps
Energy and Lighting	www.ti.com/energy
Industrial	www.ti.com/industrial
Medical	www.ti.com/medical
Security	www.ti.com/security
Space, Avionics and Defense	www.ti.com/space-avionics-defense
Transportation and Automotive	www.ti.com/automotive
Video and Imaging	www.ti.com/video

TI E2E Community Home Page

e2e.ti.com

Mailing Address: Texas Instruments, Post Office Box 655303, Dallas, Texas 75265
Copyright © 2011, Texas Instruments Incorporated