

# LM48312 Boomer™ Audio Power Amplifier Series 2.6W, Ultra-Low EMI, Filterless, Mono Class D Audio Power Amplifier with E<sup>2</sup>S

Check for Samples: [LM48312](#)

## FEATURES

- Passes FCC Class B Radiated Emissions with 20 Inches of Cable
- E<sup>2</sup>S System Reduces EMI While Preserving Audio Quality and Efficiency
- Output Short Circuit Protection with Auto-Recovery
- No Output Filter Required
- Improved Audio Quality
- Minimum External Components
- Five Logic Selectable Gain Settings (0, 3, 6, 9, 12dB)
- Low Power Shutdown Mode
- Click and Pop Suppression
- Available in Space-Saving DSBGA Package

## APPLICATIONS

- Mobile Phones
- PDAs
- Laptops

## KEY SPECIFICATIONS

- Efficiency at 3.6V, 400mW into 8Ω, 84% (Typ)
- Efficiency at 5V, 1W into 8Ω, 88% (Typ)
- Quiescent Power Supply Current at 5V, 3.1mA
- Power Output at  $V_{DD} = 5V$ ,  $R_L = 4\Omega$ 
  - THD+N ≤ 10%, 2.6W (Typ)
  - THD+N ≤ 1%, 2.1W (Typ)
- Power Output at  $V_{DD} = 5V$ ,  $R_L = 8\Omega$ 
  - THD+N ≤ 10%, 1.6W (Typ)
  - THD+N ≤ 1%, 1.3W (Typ)
- Shutdown Current, 0.01μA (Typ)

## DESCRIPTION

The LM48312 is a single supply, high efficiency, mono, 2.6W, filterless switching audio amplifier. The LM48312 features TI's Enhanced Emissions Suppression (E<sup>2</sup>S) system, that features a unique patented ultra low EMI, spread spectrum, PWM architecture, that significantly reduces RF emissions while preserving audio quality and efficiency. The E<sup>2</sup>S system improves battery life, reduces external component count, board area consumption, and system cost, simplifying design.

The LM48312 is designed to meet the demands of portable multimedia devices. Operating from a single 5V supply, the device is capable of delivering 2.6W of continuous output power to a 4Ω load with less than 10% THD+N. Flexible power supply requirements allow operation from 2.4V to 5.5V. The LM48312 features both a spread spectrum modulation scheme, and an advanced, patented edge rate control (ERC) architecture that significantly reduces emissions, while maintaining high quality audio reproduction (THD+N = 0.03%) and high efficiency ( $\eta = 88\%$ ).

The LM48312 features high efficiency compared to conventional Class AB amplifiers, and other low EMI Class D amplifiers. When driving an 8Ω speaker from a 5V supply, the device operates with 88% efficiency at  $P_O = 1W$ . The LM48312 features five gain settings, selected through a single logic input, further reducing solution size. A low power shutdown mode reduces supply current consumption to 0.01μA.

Advanced output short circuit protection with auto-recovery prevents the device from being damaged during fault conditions. Superior click and pop suppression eliminates audible transients on power-up/down and during shutdown.



Please be aware that an important notice concerning availability, standard warranty, and use in critical applications of Texas Instruments semiconductor products and disclaimers thereto appears at the end of this data sheet.

Boomer is a trademark of Texas Instruments.

All other trademarks are the property of their respective owners.

**Typical Application**

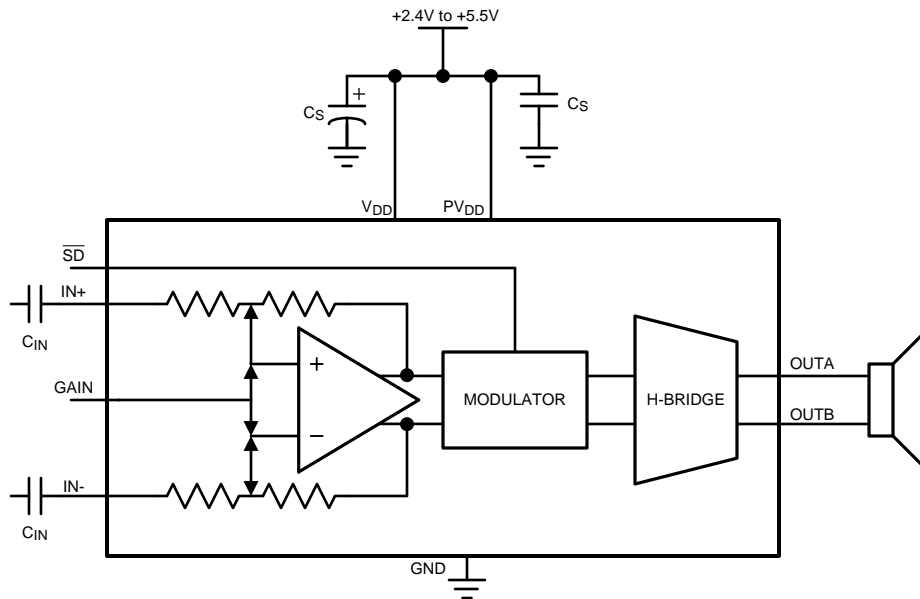

**Figure 1. Typical Audio Amplifier Application Circuit**

**Connection Diagram**

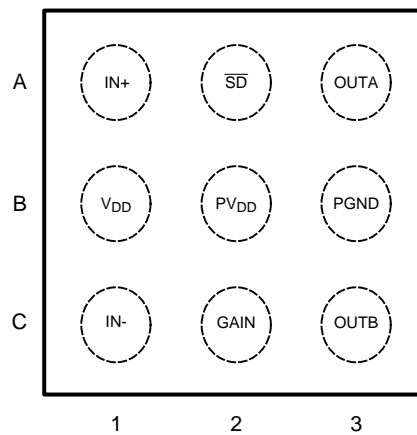

**Figure 2. DSBGA Package  
1.539mm x 1.565mm x 0.6mm  
Top View  
See Package Number YZR0009**

### BUMP DESCRIPTION

Pin	Name	Description
A1	IN+	Non-Inverting Input
A2	$\overline{SD}$	Active Low Shutdown Input. Connect to $V_{DD}$ for normal operation.
A3	OUTA	Non-Inverting Output
B1	$V_{DD}$	Power Supply
B2	$PV_{DD}$	H-Bridge Power Supply
B3	PGND	Ground
C1	IN-	Inverting Input
C2	GAIN	Gain Select: GAIN = FLOAT: $A_V = 0dB$ GAIN = $V_{DD}$ : $A_V = 3dB$ GAIN = GND: $A_V = 6dB$ GAIN = 20k $\Omega$ to GND = 9dB GAIN = 20k $\Omega$ to $V_{DD}$ = 12dB
C3	OUTB	Inverting Output



These devices have limited built-in ESD protection. The leads should be shorted together or the device placed in conductive foam during storage or handling to prevent electrostatic damage to the MOS gates.

### Absolute Maximum Ratings<sup>(1)(2)(3)</sup>

Supply Voltage	6.0V
Storage Temperature	-65°C to +150°C
Input Voltage	- 0.3V to $V_{DD} + 0.3V$
Power Dissipation <sup>(4)</sup>	Internally Limited
ESD Rating <sup>(5)</sup>	2000V
ESD Rating <sup>(6)</sup>	200V
Junction Temperature	150°C
Thermal Resistance	$\theta_{JA}$ 70°C/W
Soldering Information	
See AN-1112 (SNVA009) "DSBGA Wafer Level Chip Scale Package."	

- (1) "Absolute Maximum Ratings" indicate limits beyond which damage to the device may occur, including inoperability and degradation of device reliability and/or performance. Functional operation of the device and/or non-degradation at the *Absolute Maximum Ratings* or other conditions beyond those indicated in the *Recommended Operating Conditions* is not implied. The *Recommended Operating Conditions* indicate conditions at which the device is functional and the device should not be operated beyond such conditions. All voltages are measured with respect to the ground pin, unless otherwise specified.
- (2) The *Electrical Characteristics* tables list ensured specifications under the listed *Recommended Operating Conditions* except as otherwise modified or specified by the *Electrical Characteristics Conditions* and/or Notes. Typical specifications are estimations only and are not ensured.
- (3) If Military/Aerospace specified devices are required, please contact the Texas Instruments Sales Office/Distributors for availability and specifications.
- (4) The maximum power dissipation must be derated at elevated temperatures and is dictated by  $T_{JMAX}$ ,  $\theta_{JA}$ , and the ambient temperature,  $T_A$ . The maximum allowable power dissipation is  $P_{DMAX} = (T_{JMAX} - T_A) / \theta_{JA}$  or the number given in *Absolute Maximum Ratings*, whichever is lower.
- (5) Human body model, applicable std. JESD22-A114C.
- (6) Machine model, applicable std. JESD22-A115-A.

### Operating Ratings<sup>(1)(2)</sup>

Temperature Range	$T_{MIN} \leq T_A \leq T_{MAX}$	$-40^\circ\text{C} \leq T_A \leq +85^\circ\text{C}$
	Supply Voltage ( $V_{DD}$ , $PV_{DD}$ )	$2.4V \leq V_{DD} \leq 5.5V$

- (1) "Absolute Maximum Ratings" indicate limits beyond which damage to the device may occur, including inoperability and degradation of device reliability and/or performance. Functional operation of the device and/or non-degradation at the *Absolute Maximum Ratings* or other conditions beyond those indicated in the *Recommended Operating Conditions* is not implied. The *Recommended Operating Conditions* indicate conditions at which the device is functional and the device should not be operated beyond such conditions. All voltages are measured with respect to the ground pin, unless otherwise specified.
- (2) The *Electrical Characteristics* tables list ensured specifications under the listed *Recommended Operating Conditions* except as otherwise modified or specified by the *Electrical Characteristics Conditions* and/or Notes. Typical specifications are estimations only and are not ensured.

**Electrical Characteristics  $V_{DD} = PV_{DD} = 5V^{(1)(2)}$** 

The following specifications apply for  $A_V = 6dB$ ,  $R_L = 8\Omega$ ,  $f = 1kHz$ , unless otherwise specified. Limits apply for  $T_A = 25^\circ C$ .

Symbol	Parameter	Conditions	LM48312			Units (Limits)
			Min (3)	Typ (4)	Max (3)	
$V_{DD}$	Supply Voltage Range		2.4		5.5	V
$I_{DD}$	Quiescent Power Supply Current	$V_{IN} = 0$ , $R_L = 8\Omega$ $V_{DD} = 3.3V$ $V_{DD} = 5V$		2.6 3.1	3.3 3.9	mA mA
$I_{SD}$	Shutdown Current	Shutdown enabled		0.01	1.0	$\mu A$
$V_{OS}$	Differential Output Offset Voltage	$V_{IN} = 0$	-48	10	48	mV
$V_{IH}$	Logic Input High Voltage		1.4			V
$V_{IL}$	Logic Input Low Voltage				0.4	V
$T_{WU}$	Wake Up Time			7.5		ms
$f_{SW}$	Switching Frequency			300±30		kHz
$A_V$	Gain	GAIN = FLOAT	-0.5	0	0.5	dB
		GAIN = $V_{DD}$	2.5	3	3.5	dB
		GAIN = GND	5.5	6	6.5	dB
		GAIN = 20k $\Omega$ to GND	8.5	9	9.5	dB
		GAIN = 20k $\Omega$ to $V_{DD}$	11.5	12	12.5	dB
$R_{IN}$	Input Resistance	$A_V = 0dB$		56		k $\Omega$
		$A_V = 3dB$		49		k $\Omega$
		$A_V = 6dB$		42		k $\Omega$
		$A_V = 9dB$		35		k $\Omega$
		$A_V = 12dB$	20	27		k $\Omega$
$P_O$	Output Power	$R_L = 4\Omega$ , THD = 10% $f = 1kHz$ , 22kHz BW $V_{DD} = 5V$ $V_{DD} = 3.3V$ $V_{DD} = 2.5V$		2.6 1.1 580		W W mW
		$R_L = 8\Omega$ , THD = 10% $f = 1kHz$ , 22kHz BW $V_{DD} = 5V$ $V_{DD} = 3.3V$ $V_{DD} = 2.5V$		1.6 660 354		W mW mW
		$R_L = 4\Omega$ , THD = 1% $f = 1kHz$ , 22kHz BW $V_{DD} = 5V$ $V_{DD} = 3.3V$ $V_{DD} = 2.5V$		2.1 900 460		W mW mW
		$R_L = 8\Omega$ , THD = 1% $f = 1kHz$ , 22kHz BW $V_{DD} = 5V$ $V_{DD} = 3.3V$ $V_{DD} = 2.5V$	1.1 450	1.3 530 286		W (min) mW mW
THD+N	Total Harmonic Distortion + Noise	$P_O = 200mW$ , $R_L = 8\Omega$ , $f = 1kHz$		0.027		%
		$P_O = 100mW$ , $R_L = 8\Omega$ , $f = 1kHz$		0.03		%
PSRR	Power Supply Rejection Ratio	$V_{RIPPLE} = 200mV_{P-P}$ Sine, Inputs AC GND, $A_V = 0dB$ , $C_{IN} = 1\mu F$ $f_{RIPPLE} = 217Hz$ $f_{RIPPLE} = 1kHz$		71 70		dB dB
CMRR	Common Mode Rejection Ratio	$V_{RIPPLE} = 1V_{P-P}$ , $f_{RIPPLE} = 217Hz$ $A_V = 0dB$		65		dB

- (1) The *Electrical Characteristics* tables list ensured specifications under the listed *Recommended Operating Conditions* except as otherwise modified or specified by the *Electrical Characteristics Conditions* and/or Notes. Typical specifications are estimations only and are not ensured.
- (2)  $R_L$  is a resistive load in series with two inductors to simulate an actual speaker load. For  $R_L = 8\Omega$ , the load is  $15\mu H + 8\Omega + 15\mu H$ . For  $R_L = 4\Omega$ , the load is  $15\mu H + 4\Omega + 15\mu H$ .
- (3) Datasheet min/max specification limits are specified by test or statistical analysis.
- (4) Typical values represent most likely parametric norms at  $T_A = +25^\circ C$ , and at the *Recommended Operation Conditions* at the time of product characterization and are not ensured.

**Electrical Characteristics  $V_{DD} = PV_{DD} = 5V^{(1)(2)}$  (continued)**

The following specifications apply for  $A_V = 6dB$ ,  $R_L = 8\Omega$ ,  $f = 1kHz$ , unless otherwise specified. Limits apply for  $T_A = 25^\circ C$ .

Symbol	Parameter	Conditions	LM48312			Units (Limits)
			Min (3)	Typ (4)	Max (3)	
$\eta$	Efficiency	$V_{DD} = 5V, P_{OUT} = 1W$		88		%
		$V_{DD} = 3.3V, P_{OUT} = 400mW$		85		%
SNR	Signal to Noise Ratio	$P_O = 1W$		95		dB
CMVR	Common Mode Input Voltage Range		0	$V_{DD} - 0.25$		V
$\epsilon_{OS}$	Output Noise	Un-weighted, $A_V = 0dB$		69		$\mu V$
		A-weighted, $A_V = 0dB$		48		$\mu V$

**Test Circuits**

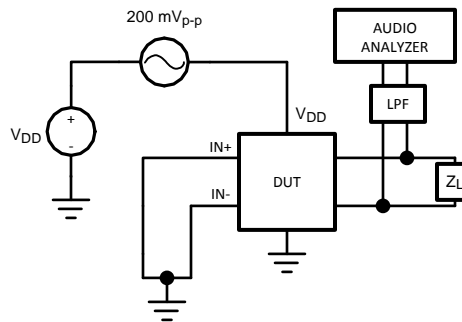

**Figure 3. PSRR Test Circuit**

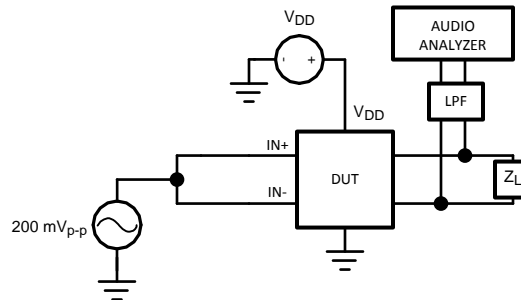

**Figure 4. CMRR Test Circuit**

### Typical Performance Characteristics

For all performance graphs, the Output Gains are set to 0dB, unless otherwise noted.

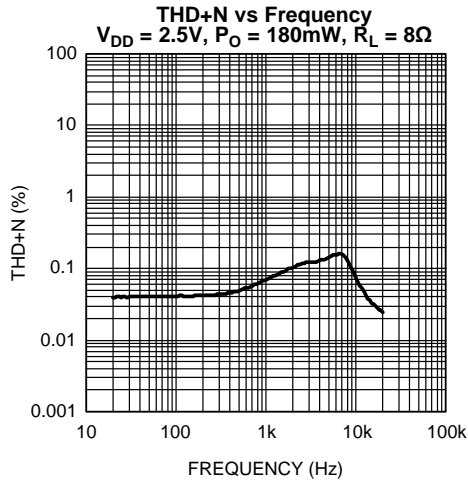

Figure 5.

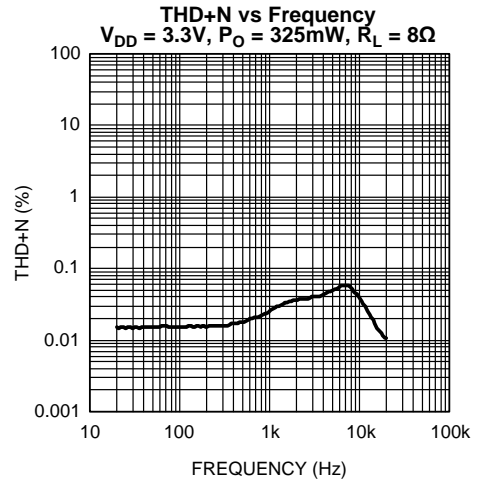

Figure 6.

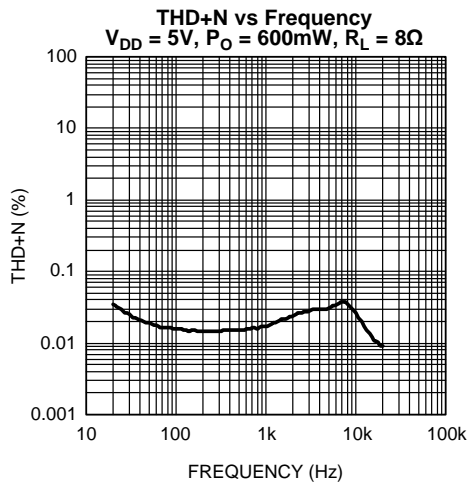

Figure 7.

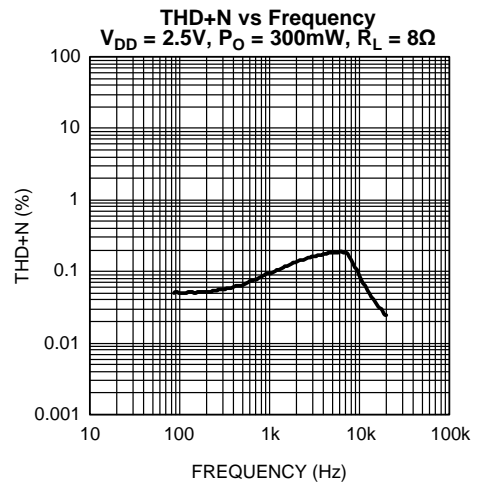

Figure 8.

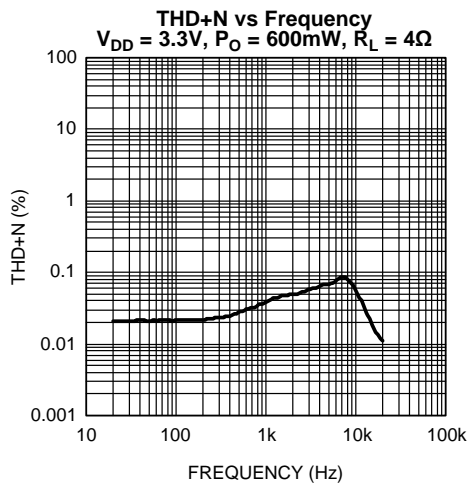

Figure 9.

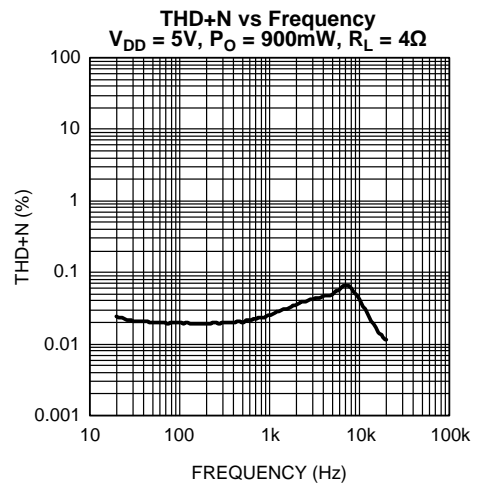

Figure 10.

**Typical Performance Characteristics (continued)**

For all performance graphs, the Output Gains are set to 0dB, unless otherwise noted.

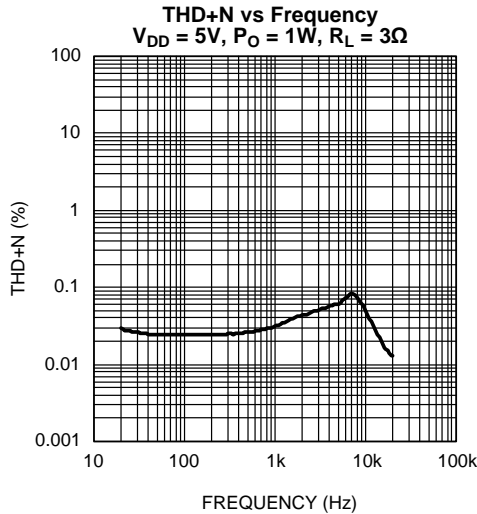

Figure 11.

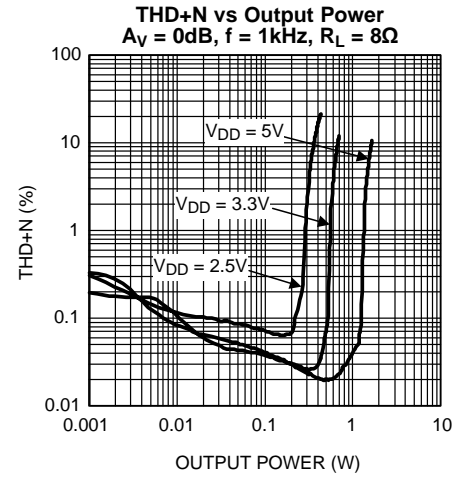

Figure 12.

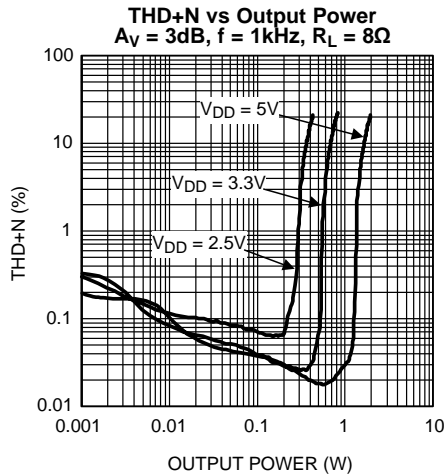

Figure 13.

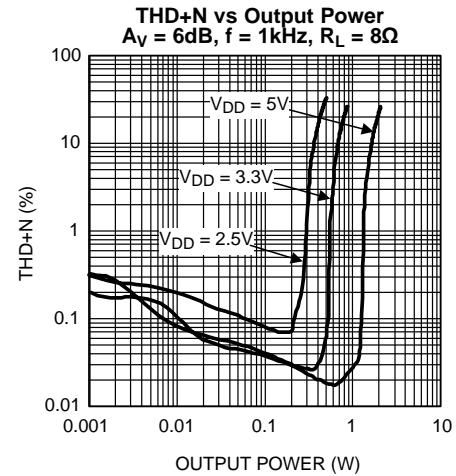

Figure 14.

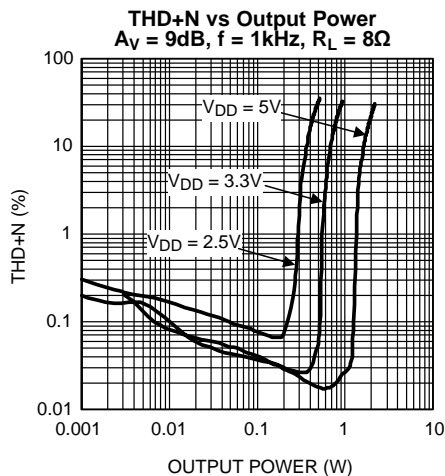

Figure 15.

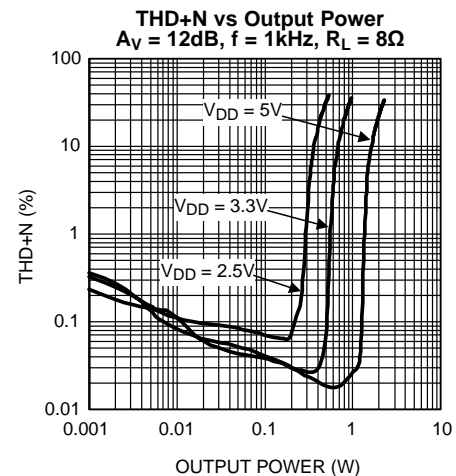

Figure 16.

**Typical Performance Characteristics (continued)**

For all performance graphs, the Output Gains are set to 0dB, unless otherwise noted.

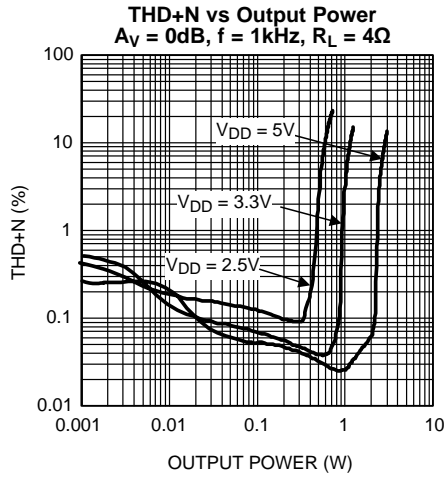

Figure 17.

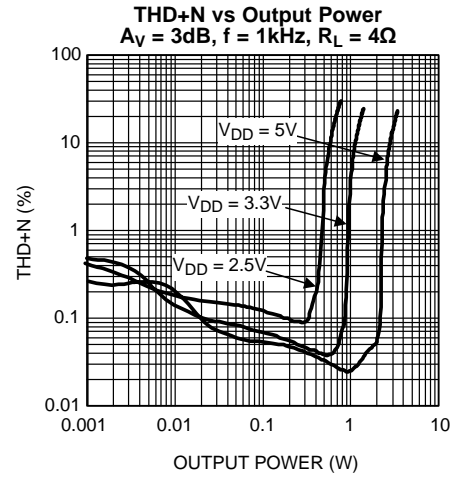

Figure 18.

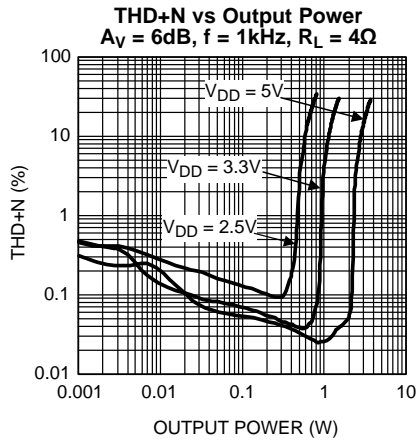

Figure 19.

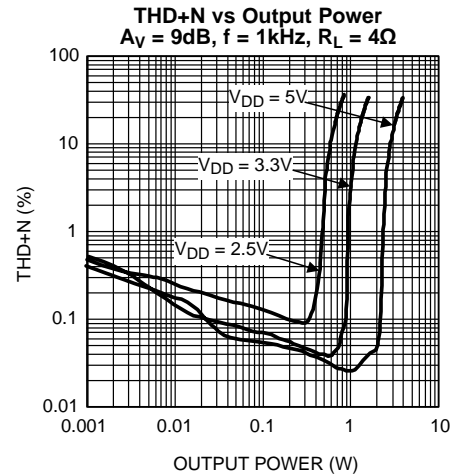

Figure 20.

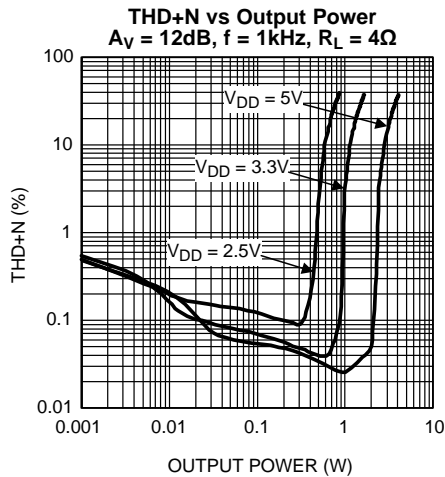

Figure 21.

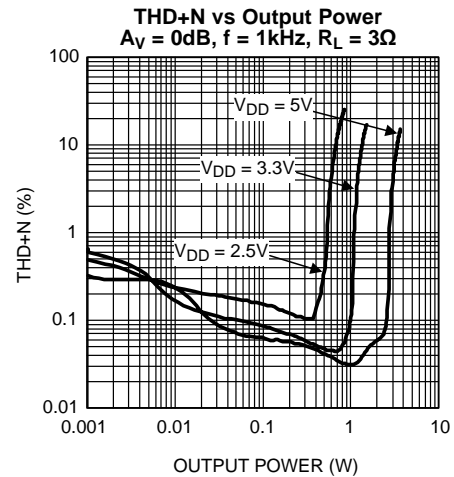

Figure 22.



Typical Performance Characteristics (continued)

For all performance graphs, the Output Gains are set to 0dB, unless otherwise noted.

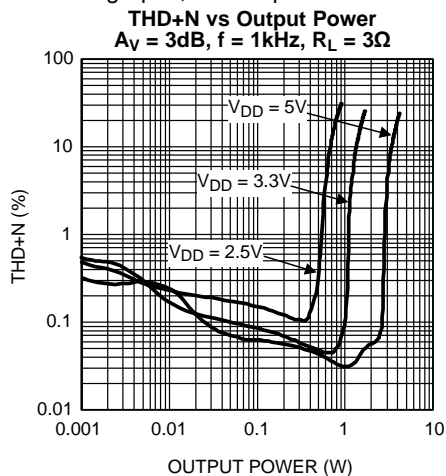

Figure 23.

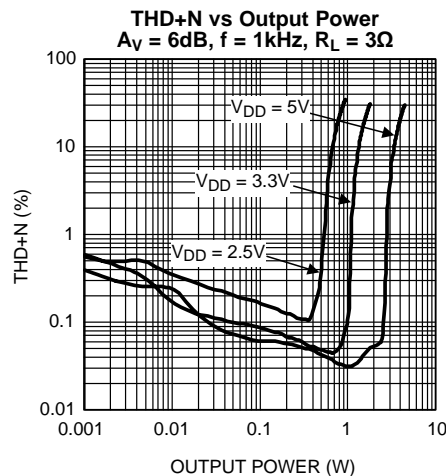

Figure 24.

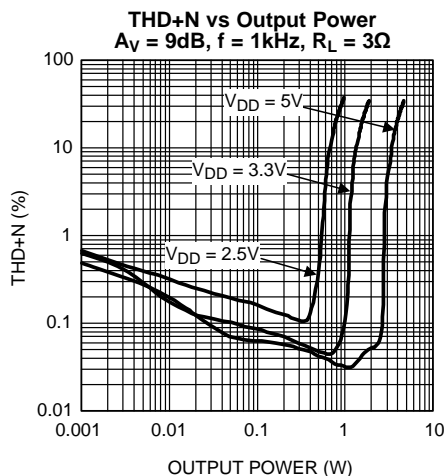

Figure 25.

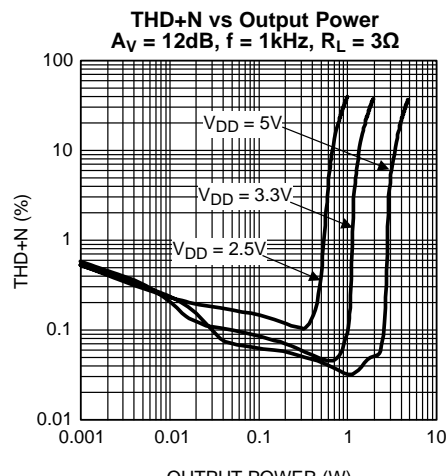

Figure 26.

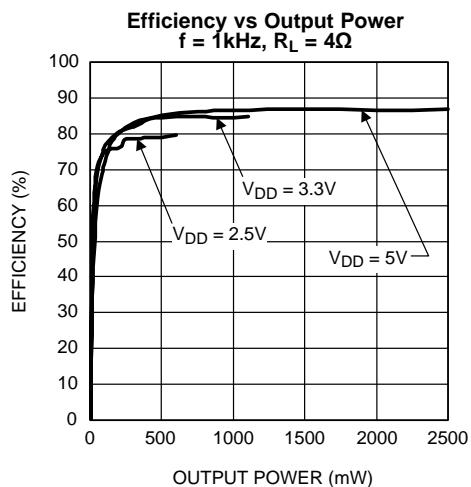

Figure 27.

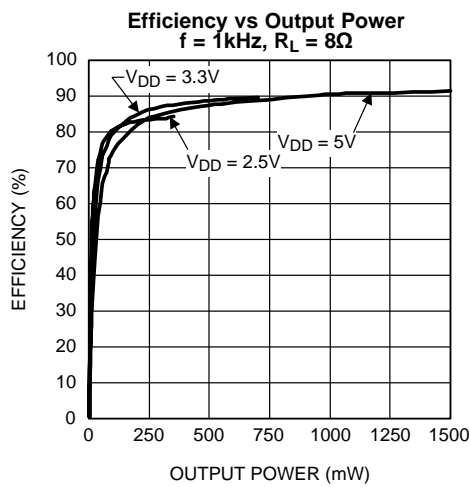

Figure 28.

### Typical Performance Characteristics (continued)

For all performance graphs, the Output Gains are set to 0dB, unless otherwise noted.

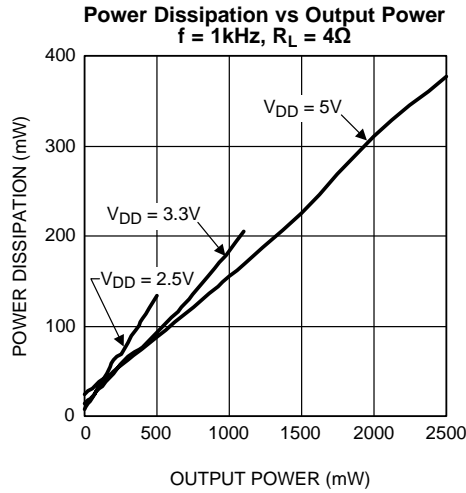

Figure 29.

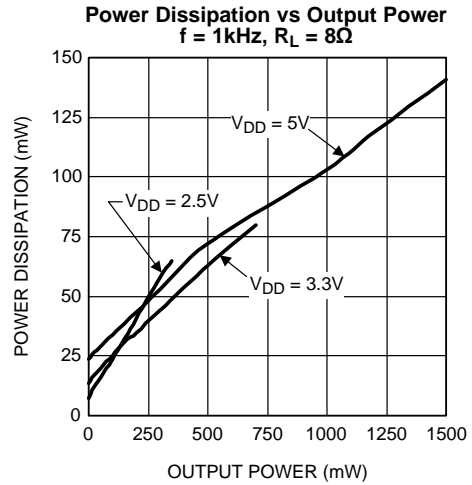

Figure 30.

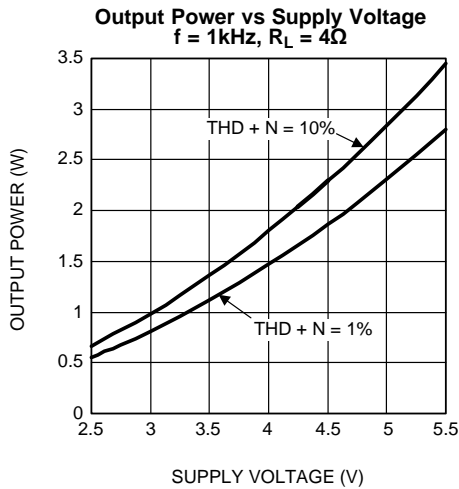

Figure 31.

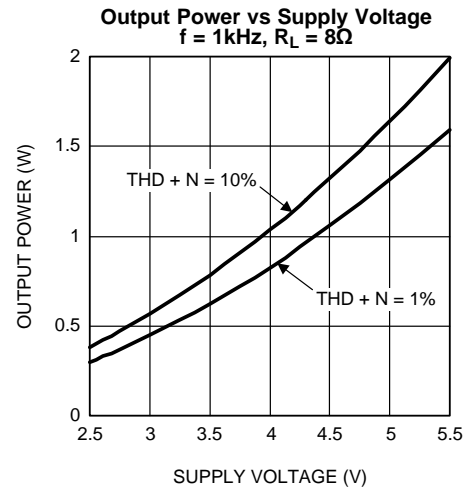

Figure 32.

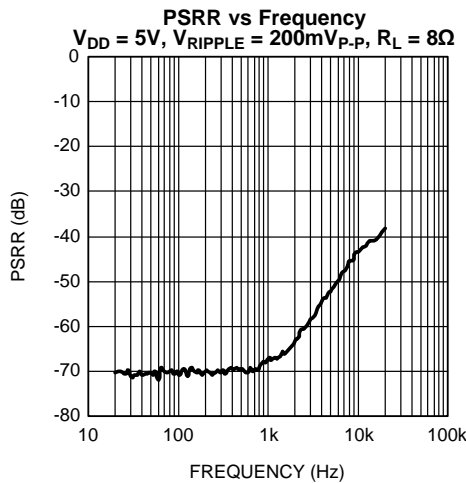

Figure 33.

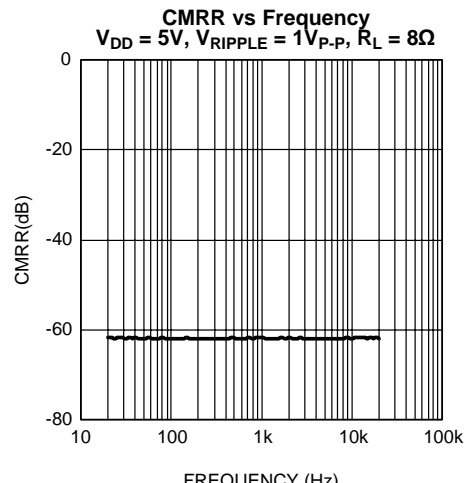

Figure 34.

### Typical Performance Characteristics (continued)

For all performance graphs, the Output Gains are set to 0dB, unless otherwise noted.

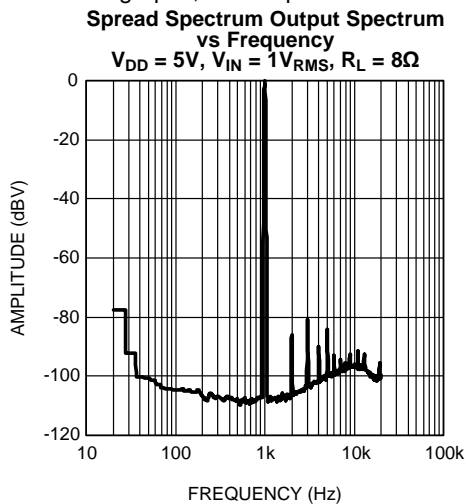

Figure 35.

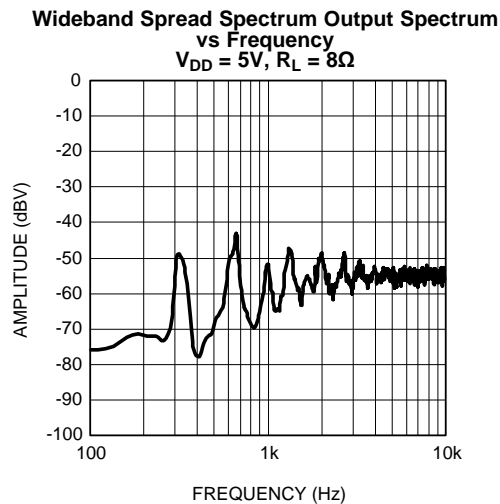

Figure 36.

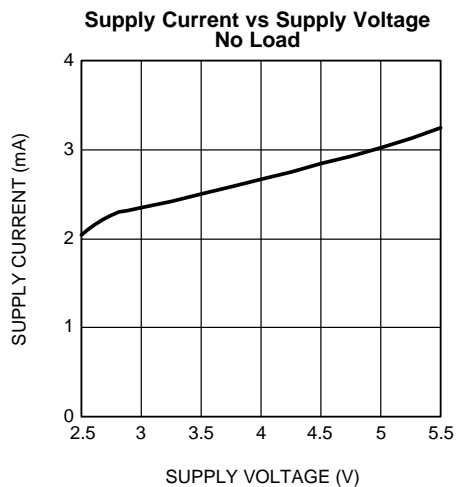

Figure 37.

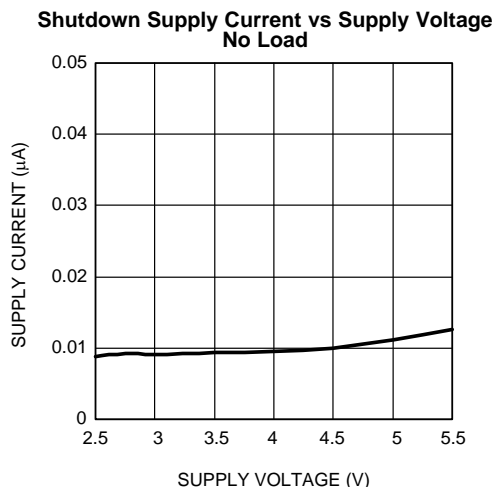

Figure 38.

## APPLICATION INFORMATION

### GENERAL AMPLIFIER FUNCTION

The LM48312 mono Class D audio power amplifier features a filterless modulation scheme that reduces external component count, conserving board space and reducing system cost. The outputs of the device transition from  $V_{DD}$  to GND with a 300kHz switching frequency. With no signal applied, the outputs ( $V_{OUTA}$  and  $V_{OUTB}$ ) switch with a 50% duty cycle, in phase, causing the two outputs to cancel. This cancellation results in no net voltage across the speaker, thus there is no current to the load in the idle state.

With the input signal applied, the duty cycle (pulse width) of the LM48312 outputs changes. For increasing output voltage, the duty cycle of  $V_{OUTA}$  increases, while the duty cycle of  $V_{OUTB}$  decreases. For decreasing output voltages, the converse occurs. The difference between the two pulse widths yields the differential output voltage.

### ENHANCED EMISSIONS SUPPRESSION SYSTEM (E<sup>2</sup>S)

The LM48312 features TI's patented E<sup>2</sup>S system that reduces EMI, while maintaining high quality audio reproduction and efficiency. The E<sup>2</sup>S system features spread spectrum and advanced edge rate control (ERC). The LM48312 ERC greatly reduces the high frequency components of the output square waves by controlling the output rise and fall times, slowing the transitions to reduce RF emissions, while maximizing THD+N and efficiency performance. The overall result of the E<sup>2</sup>S system is a filterless Class D amplifier that passes FCC Class B radiated emissions standards with 20in of twisted pair cable, with excellent 0.03% THD+N and high 88% efficiency.

### SPREAD SPECTRUM

The spread spectrum modulation reduces the need for output filters, ferrite beads or chokes. The switching frequency varies randomly by 30% about a 300kHz center frequency, reducing the wideband spectral content, improving EMI emissions radiated by the speaker and associated cables and traces. Where a fixed frequency class D exhibits large amounts of spectral energy at multiples of the switching frequency, the spread spectrum architecture of the LM48312 spreads that energy over a larger bandwidth (See [Typical Performance Characteristics](#)). The cycle-to-cycle variation of the switching period does not affect the audio reproduction, efficiency, or PSRR.

### DIFFERENTIAL AMPLIFIER EXPLANATION

As logic supplies continue to shrink, system designers are increasingly turning to differential analog signal handling to preserve signal to noise ratios with restricted voltage signs. The LM48312 features a fully differential speaker amplifier. A differential amplifier amplifies the difference between the two input signals. Traditional audio power amplifiers have typically offered only single-ended inputs resulting in a 6dB reduction of SNR relative to differential inputs. The LM48312 also offers the possibility of DC input coupling which eliminates the input coupling capacitors. A major benefit of the fully differential amplifier is the improved common mode rejection ratio (CMRR) over single ended input amplifiers. The increased CMRR of the differential amplifier reduces sensitivity to ground offset related noise injection, especially important in noisy systems.

### POWER DISSIPATION AND EFFICIENCY

The major benefit of a Class D amplifier is increased efficiency versus a Class AB. The efficiency of the LM48312 is attributed to the region of operation of the transistors in the output stage. The Class D output stage acts as current steering switches, consuming negligible amounts of power compared to their Class AB counterparts. Most of the power loss associated with the output stage is due to the IR loss of the MOSFET on-resistance, along with switching losses due to gate charge.

### GAIN SETTING

The LM48312 features five internally configured gain settings, 0, 3, 6, 9, and 12dB. The device gain is selected through a single pin (GAIN). The gain settings are shown in [Table 1](#). The gain of the LM48312 is determined at startup. When the LM48312 is powered up or brought out of shutdown, the device checks the state of GAIN, and sets the amplifier gain accordingly. Once the gain is set, the state of GAIN is ignored and the device gain cannot be changed until the device is either shutdown or powered down.

**Table 1. Gain Setting**

GAIN	GAIN SETTING
FLOAT	0dB
V <sub>DD</sub>	3dB
GND	6dB
20kΩ to GND	9dB
20kΩ to V <sub>DD</sub>	12dB

For proper gain selection:

1. Use 20kΩ resistors with 10% tolerance or better for the 9dB and 12dB gain settings.
2. Short GAIN to either V<sub>DD</sub> or GND through 100Ω or less for the 3dB and 6dB gain settings.
3. FLOAT = 20MΩ or more for the 0dB gain setting.

## SHUTDOWN FUNCTION

The LM48312 features a low current shutdown mode. Set  $\overline{SD} = GND$  to disable the amplifier and reduce supply current to 0.01μA.

Switch  $\overline{SD}$  between GND and V<sub>DD</sub> for minimum current consumption is shutdown. The LM48312 may be disabled with shutdown voltages in between GND and V<sub>DD</sub>, the idle current will be greater than the typical 0.1μA value. Increased THD+N may also be observed when a voltage of less than V<sub>DD</sub> is applied to  $\overline{SD}$ .

The LM48312 shutdown input has an internal pulldown resistor. The purpose of this resistor is to eliminate any unwanted state changes when  $\overline{SD}$  is floating. To minimize shutdown current,  $\overline{SD}$  should be driven to GND or left floating. If  $\overline{SD}$  is not driven to GND or floating, an increase in shutdown supply current will be noticed.

## PROPER SELECTION OF EXTERNAL COMPONENTS

### Audio Amplifier Power Supply Bypassing/Filtering

Proper power supply bypassing is critical for low noise performance and high PSRR. Place the supply bypass capacitors as close to the device as possible. Typical applications employ a voltage regulator with 10μF and 0.1μF bypass capacitors that increase supply stability. These capacitors do not eliminate the need for bypassing of the LM48312 supply pins. A 1μF capacitor is recommended.

### Audio Amplifier Input Capacitor Selection

Input capacitors may be required for some applications, or when the audio source is single-ended. Input capacitors block the DC component of the audio signal, eliminating any conflict between the DC component of the audio source and the bias voltage of the LM48312. The input capacitors create a high-pass filter with the input resistors R<sub>IN</sub>. The -3dB point of the high pass filter is found using [Equation 1](#) below.

$$f = 1 / 2\pi R_{IN} C_{IN} \quad (1)$$

Where R<sub>IN</sub> is the value of the input resistor given in the *Electrical Characteristics* table.

The input capacitors can also be used to remove low frequency content from the audio signal. Small speakers cannot reproduce, and may even be damaged by low frequencies. High pass filtering the audio signal helps protect the speakers. When the LM48312 is using a single-ended source, power supply noise on the ground is seen as an input signal. Setting the high-pass filter point above the power supply noise frequencies, 217Hz in a GSM phone, for example, filters out the noise such that it is not amplified and heard on the output. Capacitors with a tolerance of 10% or better are recommended for impedance matching and improved CMRR and PSRR.

### Single-Ended Audio Amplifier Configuration

The LM48312 is compatible with single-ended sources. When configured for single-ended inputs, input capacitors must be used to block and DC component at the input of the device. [Figure 39](#) shows the typical single-ended applications circuit.

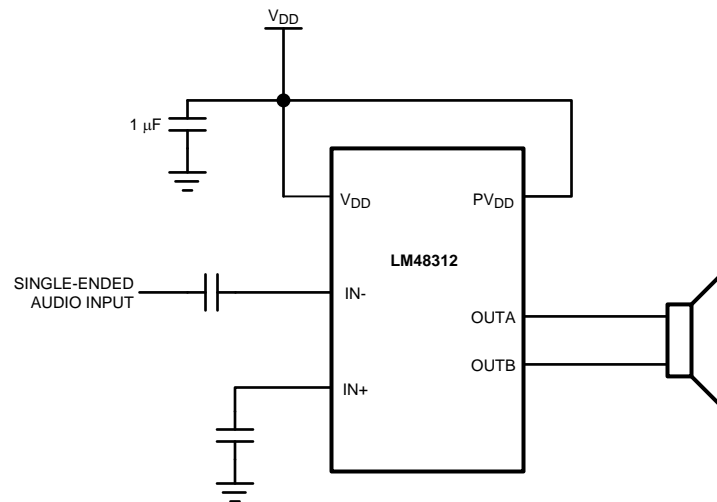

**Figure 39. Single-Ended Input Configuration**

## PCB LAYOUT GUIDELINES

As output power increases, interconnect resistance (PCB traces and wires) between the amplifier, load and power supply create a voltage drop. The voltage loss due to the traces between the LM48312 and the load results in lower output power and decreased efficiency. Higher trace resistance between the supply and the LM48312 has the same effect as a poorly regulated supply, increasing ripple on the supply line, and reducing peak output power. The effects of residual trace resistance increases as output current increases due to higher output power, decreased load impedance or both. To maintain the highest output voltage swing and corresponding peak output power, the PCB traces that connect the output pins to the load and the supply pins to the power supply should be as wide as possible to minimize trace resistance.

The use of power and ground planes will give the best THD+N performance. In addition to reducing trace resistance, the use of power planes creates parasitic capacitors that help to filter the power supply line.

The inductive nature of the transducer load can also result in overshoot on one of both edges, clamped by the parasitic diodes to GND and  $V_{DD}$  in each case. From an EMI standpoint, this is an aggressive waveform that can radiate or conduct to other components in the system and cause interference. It is essential to keep the power and output traces short and well shielded if possible. Use of ground planes beads and micro-strip layout techniques are all useful in preventing unwanted interference.

As the distance from the LM48312 and the speaker increases, the amount of EMI radiation increases due to the output wires or traces acting as antennas become more efficient with length. Ferrite chip inductors placed close to the LM48312 outputs may be needed to reduce EMI radiation.

Demo Board Schematic

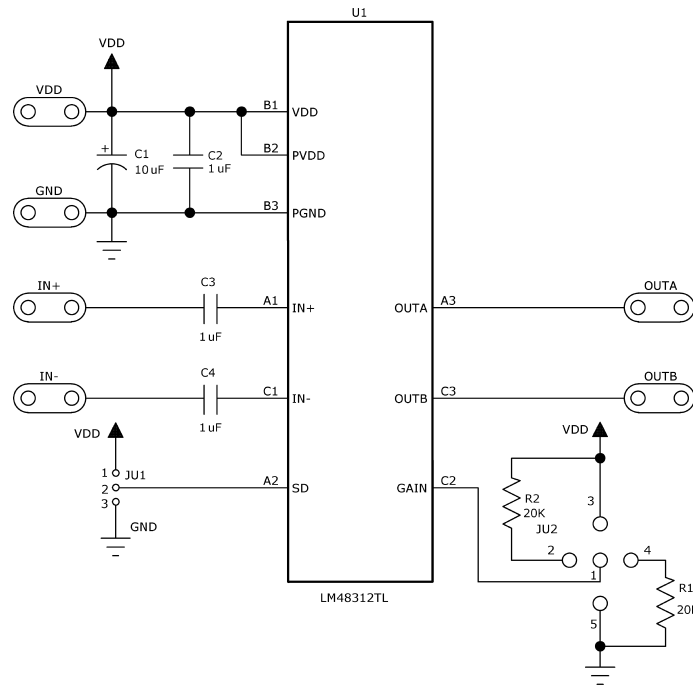

Figure 40. LM48312 Demoboard Schematic

LM48312TL Demoboard Bill of Materials

Designator	Quantity	Description
C1	1	10µF ±10% 16V Tantalum Capacitor (B Case) AVX TPSB106K016R0800
C2	1	1µF ±10% 16V X5R Ceramic Capacitor (603) Panasonic ECJ-1VB1C105K
C3, C4	2	1µF ±10% 16V X7R Ceramic Capacitor (1206) Panasonic ECJ-3YB1C105K
R1, R2	2	20kΩ ± 5% 1/10W Thick Film Resistor (603) Vishay CRCW060320R0JNEA
LM48312TL	1	LM48312TL (9-Bump DSBGA)

PC Board Layout

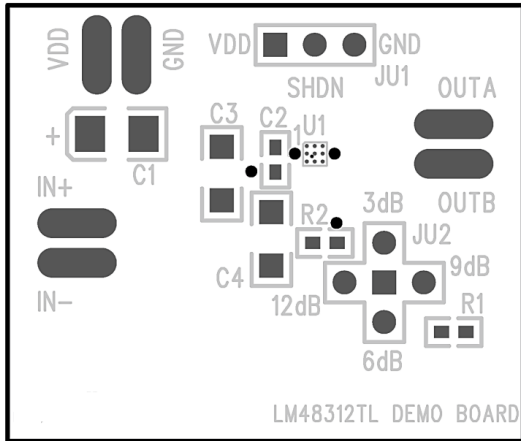

Figure 41. Top Silkscreen

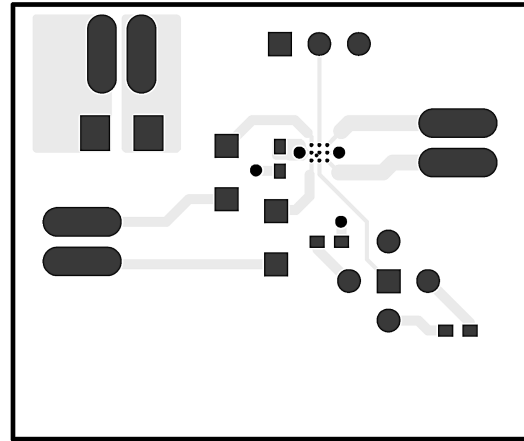

Figure 42. Top Layer

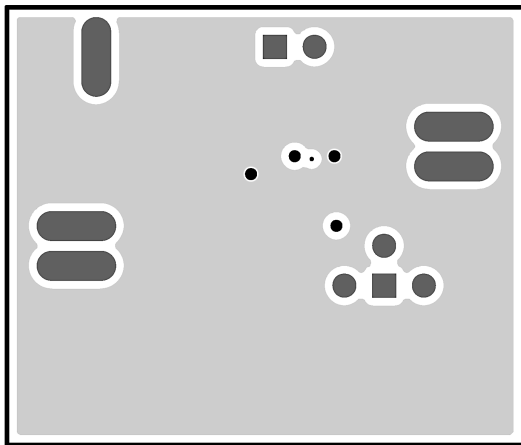

Figure 43. Layer 2 (GND)

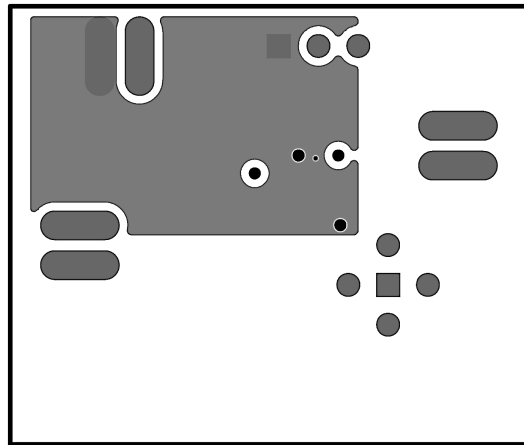

Figure 44. Layer 3 (V<sub>DD</sub>)

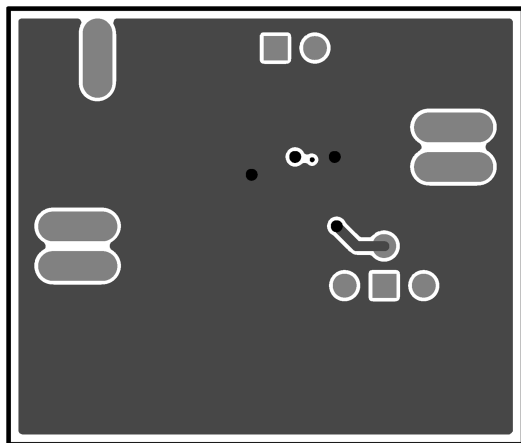

Figure 45. Bottom Layer

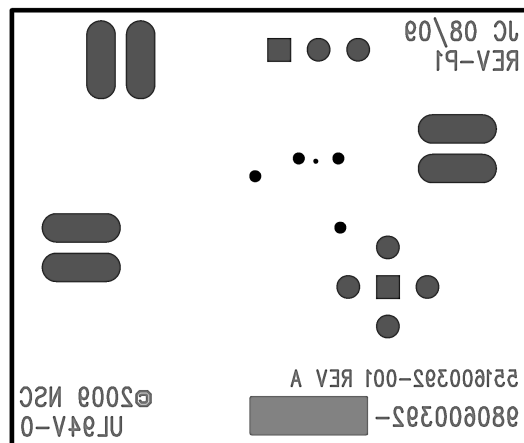

Figure 46. Bottom Silkscreen



### REVISION HISTORY

Rev	Date	Description
1.0	01/20/10	Initial WEB released.
1.01	03/19/10	Text edits under the ENHANCED EMISSIONS section.
1.02	05/13/10	Edited <a href="#">Table 1</a> .
1.03	07/25/12	Corrected the cover page (at WEB) (TI) from LM483127 to LM48312.

**Changes from Revision C (May 2013) to Revision D**
**Page**

- 
- Changed layout of National Data Sheet to TI format ..... [16](#)
-

**PACKAGING INFORMATION**

Orderable Device	Status (1)	Package Type	Package Drawing	Pins	Package Qty	Eco Plan (2)	Lead/Ball Finish	MSL Peak Temp (3)	Op Temp (°C)	Top-Side Markings (4)	Samples
LM48312TLE/NOPB	ACTIVE	DSBGA	YZR	9	250	Green (RoHS & no Sb/Br)	SNAGCU	Level-1-260C-UNLIM	-40 to 85	G N4	<a href="#">Samples</a>
LM48312TLX/NOPB	ACTIVE	DSBGA	YZR	9	3000	Green (RoHS & no Sb/Br)	SNAGCU	Level-1-260C-UNLIM	-40 to 85	G N4	<a href="#">Samples</a>

(1) The marketing status values are defined as follows:

**ACTIVE:** Product device recommended for new designs.

**LIFEBUY:** TI has announced that the device will be discontinued, and a lifetime-buy period is in effect.

**NRND:** Not recommended for new designs. Device is in production to support existing customers, but TI does not recommend using this part in a new design.

**PREVIEW:** Device has been announced but is not in production. Samples may or may not be available.

**OBSOLETE:** TI has discontinued the production of the device.

(2) Eco Plan - The planned eco-friendly classification: Pb-Free (RoHS), Pb-Free (RoHS Exempt), or Green (RoHS & no Sb/Br) - please check <http://www.ti.com/productcontent> for the latest availability information and additional product content details.

**TBD:** The Pb-Free/Green conversion plan has not been defined.

**Pb-Free (RoHS):** TI's terms "Lead-Free" or "Pb-Free" mean semiconductor products that are compatible with the current RoHS requirements for all 6 substances, including the requirement that lead not exceed 0.1% by weight in homogeneous materials. Where designed to be soldered at high temperatures, TI Pb-Free products are suitable for use in specified lead-free processes.

**Pb-Free (RoHS Exempt):** This component has a RoHS exemption for either 1) lead-based flip-chip solder bumps used between the die and package, or 2) lead-based die adhesive used between the die and leadframe. The component is otherwise considered Pb-Free (RoHS compatible) as defined above.

**Green (RoHS & no Sb/Br):** TI defines "Green" to mean Pb-Free (RoHS compatible), and free of Bromine (Br) and Antimony (Sb) based flame retardants (Br or Sb do not exceed 0.1% by weight in homogeneous material)

(3) MSL, Peak Temp. -- The Moisture Sensitivity Level rating according to the JEDEC industry standard classifications, and peak solder temperature.

(4) Multiple Top-Side Markings will be inside parentheses. Only one Top-Side Marking contained in parentheses and separated by a "~" will appear on a device. If a line is indented then it is a continuation of the previous line and the two combined represent the entire Top-Side Marking for that device.

**Important Information and Disclaimer:** The information provided on this page represents TI's knowledge and belief as of the date that it is provided. TI bases its knowledge and belief on information provided by third parties, and makes no representation or warranty as to the accuracy of such information. Efforts are underway to better integrate information from third parties. TI has taken and continues to take reasonable steps to provide representative and accurate information but may not have conducted destructive testing or chemical analysis on incoming materials and chemicals. TI and TI suppliers consider certain information to be proprietary, and thus CAS numbers and other limited information may not be available for release.

In no event shall TI's liability arising out of such information exceed the total purchase price of the TI part(s) at issue in this document sold by TI to Customer on an annual basis.

YZR0009

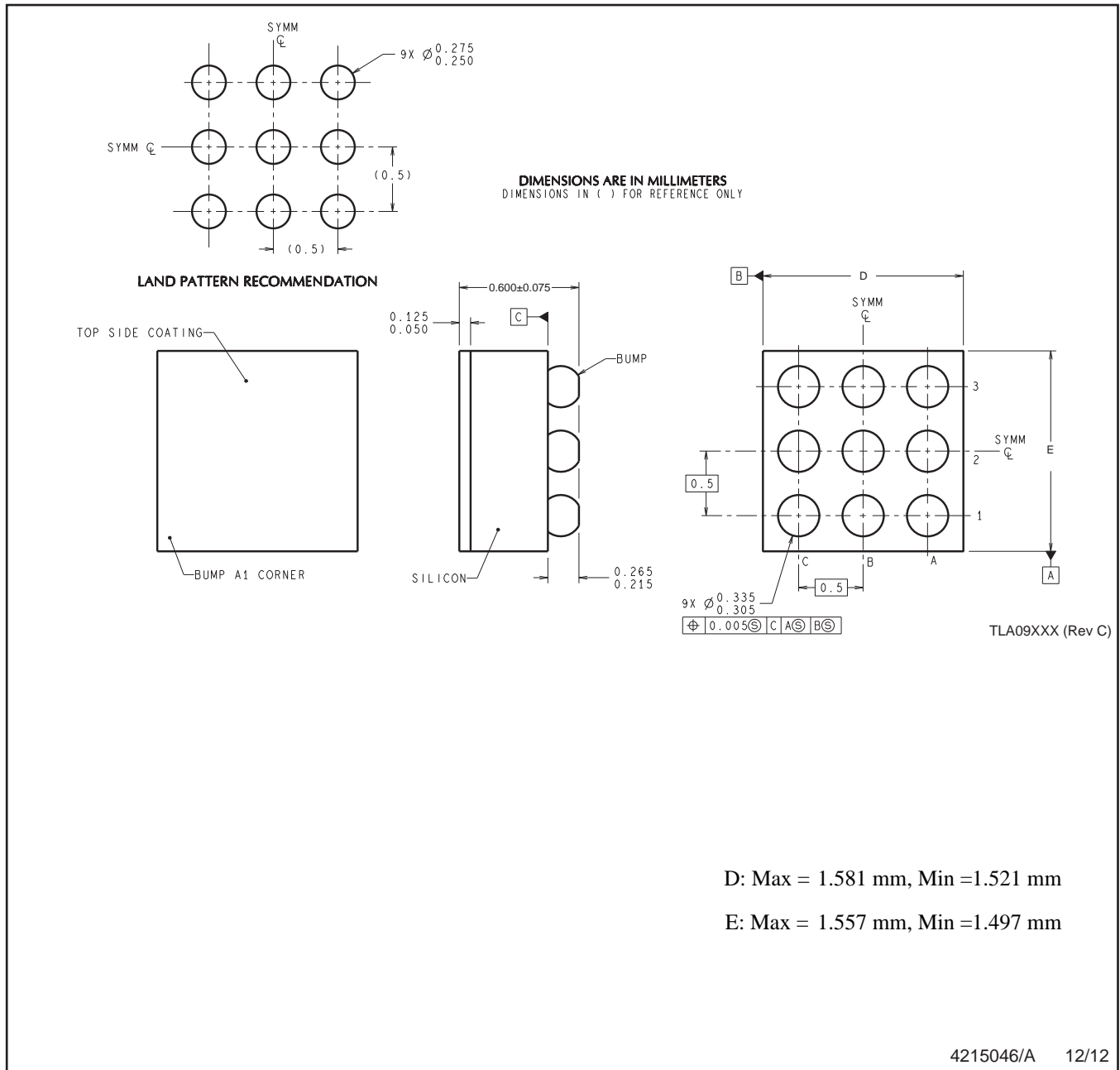

D: Max = 1.581 mm, Min =1.521 mm

E: Max = 1.557 mm, Min =1.497 mm

NOTES: A. All linear dimensions are in millimeters. Dimensioning and tolerancing per ASME Y14.5M-1994.  
B. This drawing is subject to change without notice.

## IMPORTANT NOTICE

Texas Instruments Incorporated and its subsidiaries (TI) reserve the right to make corrections, enhancements, improvements and other changes to its semiconductor products and services per JESD46, latest issue, and to discontinue any product or service per JESD48, latest issue. Buyers should obtain the latest relevant information before placing orders and should verify that such information is current and complete. All semiconductor products (also referred to herein as "components") are sold subject to TI's terms and conditions of sale supplied at the time of order acknowledgment.

TI warrants performance of its components to the specifications applicable at the time of sale, in accordance with the warranty in TI's terms and conditions of sale of semiconductor products. Testing and other quality control techniques are used to the extent TI deems necessary to support this warranty. Except where mandated by applicable law, testing of all parameters of each component is not necessarily performed.

TI assumes no liability for applications assistance or the design of Buyers' products. Buyers are responsible for their products and applications using TI components. To minimize the risks associated with Buyers' products and applications, Buyers should provide adequate design and operating safeguards.

TI does not warrant or represent that any license, either express or implied, is granted under any patent right, copyright, mask work right, or other intellectual property right relating to any combination, machine, or process in which TI components or services are used. Information published by TI regarding third-party products or services does not constitute a license to use such products or services or a warranty or endorsement thereof. Use of such information may require a license from a third party under the patents or other intellectual property of the third party, or a license from TI under the patents or other intellectual property of TI.

Reproduction of significant portions of TI information in TI data books or data sheets is permissible only if reproduction is without alteration and is accompanied by all associated warranties, conditions, limitations, and notices. TI is not responsible or liable for such altered documentation. Information of third parties may be subject to additional restrictions.

Resale of TI components or services with statements different from or beyond the parameters stated by TI for that component or service voids all express and any implied warranties for the associated TI component or service and is an unfair and deceptive business practice. TI is not responsible or liable for any such statements.

Buyer acknowledges and agrees that it is solely responsible for compliance with all legal, regulatory and safety-related requirements concerning its products, and any use of TI components in its applications, notwithstanding any applications-related information or support that may be provided by TI. Buyer represents and agrees that it has all the necessary expertise to create and implement safeguards which anticipate dangerous consequences of failures, monitor failures and their consequences, lessen the likelihood of failures that might cause harm and take appropriate remedial actions. Buyer will fully indemnify TI and its representatives against any damages arising out of the use of any TI components in safety-critical applications.

In some cases, TI components may be promoted specifically to facilitate safety-related applications. With such components, TI's goal is to help enable customers to design and create their own end-product solutions that meet applicable functional safety standards and requirements. Nonetheless, such components are subject to these terms.

No TI components are authorized for use in FDA Class III (or similar life-critical medical equipment) unless authorized officers of the parties have executed a special agreement specifically governing such use.

Only those TI components which TI has specifically designated as military grade or "enhanced plastic" are designed and intended for use in military/aerospace applications or environments. Buyer acknowledges and agrees that any military or aerospace use of TI components which have **not** been so designated is solely at the Buyer's risk, and that Buyer is solely responsible for compliance with all legal and regulatory requirements in connection with such use.

TI has specifically designated certain components as meeting ISO/TS16949 requirements, mainly for automotive use. In any case of use of non-designated products, TI will not be responsible for any failure to meet ISO/TS16949.

### Products

Audio	<a href="http://www.ti.com/audio">www.ti.com/audio</a>
Amplifiers	<a href="http://amplifier.ti.com">amplifier.ti.com</a>
Data Converters	<a href="http://dataconverter.ti.com">dataconverter.ti.com</a>
DLP® Products	<a href="http://www.dlp.com">www.dlp.com</a>
DSP	<a href="http://dsp.ti.com">dsp.ti.com</a>
Clocks and Timers	<a href="http://www.ti.com/clocks">www.ti.com/clocks</a>
Interface	<a href="http://interface.ti.com">interface.ti.com</a>
Logic	<a href="http://logic.ti.com">logic.ti.com</a>
Power Mgmt	<a href="http://power.ti.com">power.ti.com</a>
Microcontrollers	<a href="http://microcontroller.ti.com">microcontroller.ti.com</a>
RFID	<a href="http://www.ti-rfid.com">www.ti-rfid.com</a>
OMAP Applications Processors	<a href="http://www.ti.com/omap">www.ti.com/omap</a>
Wireless Connectivity	<a href="http://www.ti.com/wirelessconnectivity">www.ti.com/wirelessconnectivity</a>

### Applications

Automotive and Transportation	<a href="http://www.ti.com/automotive">www.ti.com/automotive</a>
Communications and Telecom	<a href="http://www.ti.com/communications">www.ti.com/communications</a>
Computers and Peripherals	<a href="http://www.ti.com/computers">www.ti.com/computers</a>
Consumer Electronics	<a href="http://www.ti.com/consumer-apps">www.ti.com/consumer-apps</a>
Energy and Lighting	<a href="http://www.ti.com/energy">www.ti.com/energy</a>
Industrial	<a href="http://www.ti.com/industrial">www.ti.com/industrial</a>
Medical	<a href="http://www.ti.com/medical">www.ti.com/medical</a>
Security	<a href="http://www.ti.com/security">www.ti.com/security</a>
Space, Avionics and Defense	<a href="http://www.ti.com/space-avionics-defense">www.ti.com/space-avionics-defense</a>
Video and Imaging	<a href="http://www.ti.com/video">www.ti.com/video</a>

### TI E2E Community

[e2e.ti.com](http://e2e.ti.com)