

**FEATURES**

- **1.225-V Fixed and Adjustable Outputs (1.225 V to 10 V)**
- **Tight Output Tolerances and Low Temperature Coefficient**
  - Max 0.1%, 100 ppm/°C – A Grade
  - Max 0.2%, 100 ppm/°C – B Grade
  - Max 0.5%, 100 ppm/°C – C Grade
  - Max 1.0%, 150 ppm/°C – D Grade
- **Low Output Noise . . . 20  $\mu$ V<sub>RMS</sub> (Typ)**
- **Wide Operating Current Range . . . 45  $\mu$ A (Typ) to 12 mA**
- **Stable With All Capacitive Loads; No Output Capacitor Required**
- **Available in**
  - Industrial Temperature: –40°C to 85°C
  - Extended Temperature: –40°C to 125°C

- **Applications**
  - Data-Acquisition Systems
  - Power Supplies and Power-Supply Monitors
  - Instrumentation and Test Equipment
  - Process Control
  - Precision Audio
  - Automotive Electronics
  - Energy Management/Metering
  - Battery-Powered Equipment

1.2 V . . . DBZ (SOT-23) PACKAGE  
(TOP VIEW)

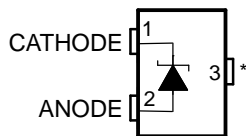

\* Pin 3 must be connected to ANODE or left open.

1.2 V . . . DCK (SC-70) PACKAGE  
(TOP VIEW)

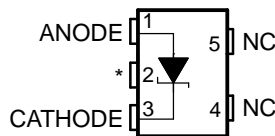

NC – No internal connection  
\* Pin 2 must be connected to ANODE or left open.

1.2 V . . . LP (TO-92/TO-226) PACKAGE  
(TOP VIEW)

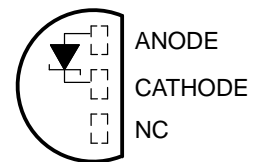

NC – No internal connection

Adjustable . . . DBZ (SOT-23) PACKAGE  
(TOP VIEW)

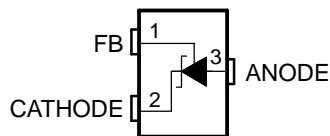

Adjustable . . . DCK (SC-70) PACKAGE  
(TOP VIEW)

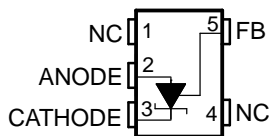

NC – No internal connection

Adjustable . . . LP (TO-92/TO-226) PACKAGE  
(TOP VIEW)

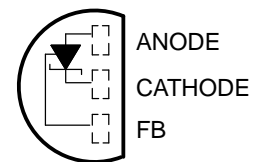

**DESCRIPTION/ORDERING INFORMATION**

The LM4041 series of shunt voltage references are versatile, easy-to-use references suitable for a wide array of applications. They require no external capacitors for operation and are stable with all capacitive loads. Additionally, the reference offers low dynamic impedance, low noise, and a low temperature coefficient to ensure a stable output voltage over a wide range of operating currents and temperatures. The LM4041 uses fuse and Zener-zap reverse breakdown voltage trim during wafer sort to offer four output voltage tolerances, ranging from 0.1% (max) for the A grade to 1% (max) for the D grade. Thus, a great deal of flexibility is offered to designers in choosing the best cost-to-performance ratio for their applications. The LM4041 is available in a fixed (1.225 V nominal) or an adjustable version (which requires an external resistor divider to set the output to a value between 1.225 V and 10 V).



Please be aware that an important notice concerning availability, standard warranty, and use in critical applications of Texas Instruments semiconductor products and disclaimers thereto appears at the end of this data sheet.

# LM4041

## PRECISION MICROPOWER SHUNT VOLTAGE REFERENCE

SLCS146E—FEBRUARY 2005—REVISED FEBRUARY 2006

Packaged in space-saving SC-70 and SOT-23-3 and requiring a minimum current of 45  $\mu$ A (typ), the LM4041 also is ideal for portable applications. The TO-92 package also is available for through-hole packaging needs. The LM4041xl is characterized for operation over an ambient temperature range of  $-40^{\circ}\text{C}$  to  $85^{\circ}\text{C}$ . The LM4041xQ is characterized for operation over an ambient temperature range of  $-40^{\circ}\text{C}$  to  $125^{\circ}\text{C}$ .

### ORDERING INFORMATION

T <sub>A</sub>	DEVICE GRADE	V <sub>Z</sub>	PACKAGE <sup>(1)</sup>		ORDERABLE PART NUMBER	TOP-SIDE MARKING <sup>(2)</sup>
$-40^{\circ}\text{C}$ to $85^{\circ}\text{C}$	A grade: 0.1% initial accuracy and 100 ppm/ $^{\circ}\text{C}$ temperature coefficient	1.2 V	SC-70 (DCK)	Reel of 3000	LM4041A12IDCKR	MK_
				Reel of 250	LM4041A12IDBZR	4MK_
			SOT-23-3 (DBZ)	Bulk of 1000	LM4041A12ILP	PREVIEW
				Reel of 2000	LM4041A12ILPR	
			TO-92/TO-226 (LP)	Reel of 3000	LM4041B1DCKR	MG_
				Reel of 250	LM4041B1DCKT	
	B grade: 0.2% initial accuracy and 100 ppm/ $^{\circ}\text{C}$ temperature coefficient	ADJ	SC-70 (DCK)	Reel of 3000	LM4041B1DBZR	4MG_
				Reel of 250	LM4041B1DBZT	
			SOT-23-3 (DBZ)	Bulk of 1000	LM4041B1ILP	PREVIEW
				Reel of 2000	LM4041B1ILPR	
			TO-92/TO-226 (LP)	Reel of 3000	LM4041B12IDCKR	ML_
				Reel of 250	LM4041B12IDBZR	
	C grade: 0.5% initial accuracy and 100 ppm/ $^{\circ}\text{C}$ temperature coefficient	1.2 V	SC-70 (DCK)	Reel of 3000	LM4041B12IDBZT	4ML_
				Reel of 250	LM4041B12IDBZT	
			SOT-23-3 (DBZ)	Bulk of 1000	LM4041B12ILP	PREVIEW
				Reel of 2000	LM4041B12ILPR	
			TO-92/TO-226 (LP)	Reel of 3000	LM4041C1DCKR	MH_
				Reel of 250	LM4041C1DCKT	
	D grade: 1.0% initial accuracy and 150 ppm/ $^{\circ}\text{C}$ temperature coefficient	ADJ	SC-70 (DCK)	Reel of 3000	LM4041C1DBZR	4MH_
				Reel of 250	LM4041C1DBZT	
			SOT-23-3 (DBZ)	Bulk of 1000	LM4041C1ILP	PREVIEW
				Reel of 2000	LM4041C1ILPR	
			TO-92/TO-226 (LP)	Reel of 3000	LM4041C12IDCKR	MM_
				Reel of 250	LM4041C12IDBZR	
D grade: 1.0% initial accuracy and 150 ppm/ $^{\circ}\text{C}$ temperature coefficient	1.2 V	SC-70 (DCK)	Reel of 3000	LM4041C12IDBZT	4MM_	
			Reel of 250	LM4041C12IDBZT		
		SOT-23-3 (DBZ)	Bulk of 1000	LM4041C12ILP	PREVIEW	
			Reel of 2000	LM4041C12ILPR		
		TO-92/TO-226 (LP)	Reel of 3000	LM4041D1DCKR	MJ_	
			Reel of 250	LM4041D1DCKT		
D grade: 1.0% initial accuracy and 150 ppm/ $^{\circ}\text{C}$ temperature coefficient	ADJ	SC-70 (DCK)	Reel of 3000	LM4041D1DBZR	4MJ_	
			Reel of 250	LM4041D1DBZT		
		SOT-23-3 (DBZ)	Bulk of 1000	LM4041D1ILP	PREVIEW	
			Reel of 2000	LM4041D1ILPR		
		TO-92/TO-226 (LP)	Reel of 3000	LM4041D12IDCKR	MN_	
			Reel of 250	LM4041D12IDBZR		
D grade: 1.0% initial accuracy and 150 ppm/ $^{\circ}\text{C}$ temperature coefficient	1.2 V	SC-70 (DCK)	Reel of 3000	LM4041D12IDBZT	4MN_	
			Reel of 250	LM4041D12IDBZT		
		SOT-23-3 (DBZ)	Bulk of 1000	LM4041D12ILP	PREVIEW	
			Reel of 2000	LM4041D12ILPR		
		TO-92/TO-226 (LP)	Reel of 3000	LM4041D12IDCKR	MN_	
			Reel of 250	LM4041D12IDBZR		

(1) Package drawings, standard packing quantities, thermal data, symbolization, and PCB design guidelines are available at [www.ti.com/sc/package](http://www.ti.com/sc/package).

(2) DBZ/DCK: The actual top-side marking has one additional character that designates the assembly/test site.

**ORDERING INFORMATION**

T <sub>A</sub>	DEVICE GRADE	V <sub>Z</sub>	PACKAGE <sup>(1)</sup>		ORDERABLE PART NUMBER	TOP-SIDE MARKING <sup>(2)</sup>
-40°C to 125°C	C grade: 0.5% initial accuracy and 100 ppm/°C temperature coefficient	ADJ	SOT-23-3 (DBZ)	Reel of 3000	LM4041CQDBZR	4MP_
				Reel of 250	LM4041CQDBZT	
		1.2 V	SOT-23-3 (DBZ)	Reel of 3000	LM4041C12QDBZR	4MS_
				Reel of 250	LM4041C12QDBZT	
	D grade: 1.0% initial accuracy and 150 ppm/°C temperature coefficient	ADJ	SOT-23-3 (DBZ)	Reel of 3000	LM4041DQDBZR	4MR_
				Reel of 250	LM4041DQDBZT	
		1.2 V	SOT-23-3 (DBZ)	Reel of 3000	LM4041D12QDBZR	4MT_
				Reel of 250	LM4041D12QDBZT	

(1) Package drawings, standard packing quantities, thermal data, symbolization, and PCB design guidelines are available at [www.ti.com/sc/package](http://www.ti.com/sc/package).

(2) DBZ/DCK: The actual top-side marking has one additional character that designates the assembly/test site.

# LM4041 PRECISION MICROPOWER SHUNT VOLTAGE REFERENCE

SLCS146E—FEBRUARY 2005—REVISED FEBRUARY 2006

## FUNCTIONAL BLOCK DIAGRAM



- (1) LM4041x (ADJ) only  
(2) LM4041x12 only

## Absolute Maximum Ratings<sup>(1)</sup>

over free-air temperature range (unless otherwise noted)

		MIN	MAX	UNIT
$V_Z$	Continuous cathode voltage		15	V
$I_Z$	Continuous cathode current	-10	25	mA
$\theta_{JA}$	Package thermal impedance <sup>(2)(3)</sup>	DBZ package	206	°C/W
		DCK package	252	
		LP package	156	
$T_J$	Operating virtual junction temperature		150	°C
$T_{stg}$	Storage temperature range	-65	150	°C

- (1) Stresses beyond those listed under "absolute maximum ratings" may cause permanent damage to the device. These are stress ratings only, and functional operation of the device at these or any other conditions beyond those indicated under "recommended operating conditions" is not implied. Exposure to absolute-maximum-rated conditions for extended periods may affect device reliability.  
(2) Maximum power dissipation is a function of  $T_J(\text{max})$ ,  $\theta_{JA}$ , and  $T_A$ . The maximum allowable power dissipation at any allowable ambient temperature is  $P_D = (T_J(\text{max}) - T_A)/\theta_{JA}$ . Operating at the absolute maximum  $T_J$  of 150°C can affect reliability.  
(3) The package thermal impedance is calculated in accordance with JESD 51-7.

## Recommended Operating Conditions

		MIN	MAX	UNIT
$I_Z$	Cathode current	(1)	12	mA
$V_Z$	Reverse breakdown voltage (adjustable version)		10	V
$T_A$	Free-air temperature	LM4041 (I temperature)	-40	°C
		LM4041 (Q temperature)	-40	

- (1) See parametric tables

### LM4041x12I Electrical Characteristics

full-range  $T_A = -40^\circ\text{C}$  to  $85^\circ\text{C}$  (unless otherwise noted)

PARAMETER	TEST CONDITIONS	$T_A$	LM4041A12I			LM4041B12I			UNIT	
			MIN	TYP	MAX	MIN	TYP	MAX		
$V_Z$	Reverse breakdown voltage	$I_Z = 100\ \mu\text{A}$	1.225			1.225			V	
	Reverse breakdown voltage tolerance	$25^\circ\text{C}$	-1.2		1.2	-2.4		2.4	mV	
		Full range	-9.2		9.2	-10.4		10.4		
$I_{Z,\text{min}}$	Minimum cathode current	$25^\circ\text{C}$		45	75		45	75	$\mu\text{A}$	
		Full range			80			80		
$\alpha_{VZ}$	Average temperature coefficient of reverse breakdown voltage	$I_Z = 10\ \text{mA}$	$\pm 20$			$\pm 20$			ppm/ $^\circ\text{C}$	
		$I_Z = 1\ \text{mA}$	$25^\circ\text{C}$	$\pm 15$			$\pm 15$			
			Full range	$\pm 100$			$\pm 100$			
		$I_Z = 100\ \mu\text{A}$	$25^\circ\text{C}$	$\pm 15$			$\pm 15$			
$\Delta V_Z/\Delta I_Z$	Reverse breakdown voltage change with cathode current change	$I_{Z,\text{min}} < I_Z < 1\ \text{mA}$	$25^\circ\text{C}$	0.7	1.5	0.7	1.5	mV		
			Full range	2			2			
		$1\ \text{mA} < I_Z < 12\ \text{mA}$	$25^\circ\text{C}$	4	6	4	6			
			Full range	8			8			
$Z_Z$	Reverse dynamic impedance	$I_Z = 1\ \text{mA}$ , $f = 120\ \text{Hz}$ , $I_{AC} = 0.1\ I_Z$	$25^\circ\text{C}$	0.5	1.5	0.5	1.5	$\Omega$		
$e_N$	Wideband noise	$I_Z = 100\ \mu\text{A}$ , $10\ \text{Hz} \leq f \leq 10\ \text{kHz}$	$25^\circ\text{C}$	20			20			$\mu\text{V}_{\text{RMS}}$
	Long-term stability of reverse breakdown voltage	$t = 1000\ \text{h}$ , $T_A = 25^\circ\text{C} \pm 0.1^\circ\text{C}$ , $I_Z = 100\ \mu\text{A}$	$25^\circ\text{C}$	120			120			ppm

# LM4041 PRECISION MICROPOWER SHUNT VOLTAGE REFERENCE

SLCS146E—FEBRUARY 2005—REVISED FEBRUARY 2006

## LM4041x12I Electrical Characteristics

full-range  $T_A = -40^\circ\text{C}$  to  $85^\circ\text{C}$  (unless otherwise noted)

PARAMETER	TEST CONDITIONS	$T_A$	LM4041C12I			LM4041D12I			UNIT
			MIN	TYP	MAX	MIN	TYP	MAX	
$V_Z$	Reverse breakdown voltage	$I_Z = 100\ \mu\text{A}$	1.225			1.225			V
	Reverse breakdown voltage tolerance	$I_Z = 100\ \mu\text{A}$	25°C		-6	6	-12	12	mV
			Full range		-14	14	-24	24	
$I_{Z,\text{min}}$	Minimum cathode current		25°C		45	75	45	75	$\mu\text{A}$
			Full range		80				
$\alpha_{VZ}$	Average temperature coefficient of reverse breakdown voltage	$I_Z = 10\ \text{mA}$	25°C		$\pm 20$		$\pm 20$		ppm/°C
		$I_Z = 1\ \text{mA}$	25°C		$\pm 15$		$\pm 15$		
			Full range		$\pm 100$		$\pm 150$		
		$I_Z = 100\ \mu\text{A}$	25°C		$\pm 15$		$\pm 15$		
$\Delta V_Z/\Delta I_Z$	Reverse breakdown voltage change with cathode current change	$I_{Z,\text{min}} < I_Z < 1\ \text{mA}$	25°C		0.7	1.5	0.7	2	mV
			Full range		2		2.5		
		$1\ \text{mA} < I_Z < 12\ \text{mA}$	25°C		2.5	6	2.5	8	
			Full range		8		10		
$Z_Z$	Reverse dynamic impedance	$I_Z = 1\ \text{mA}$ , $f = 120\ \text{Hz}$ , $I_{AC} = 0.1\ I_Z$	25°C		0.5	1.5	0.5	2	$\Omega$
$e_N$	Wideband noise	$I_Z = 100\ \mu\text{A}$ , $10\ \text{Hz} \leq f \leq 10\ \text{kHz}$	25°C		20		20		$\mu\text{V}_{\text{RMS}}$
	Long-term stability of reverse breakdown voltage	$t = 1000\ \text{h}$ , $T_A = 25^\circ\text{C} \pm 0.1^\circ\text{C}$ , $I_Z = 100\ \mu\text{A}$	25°C		120		120		ppm

### LM4041x12Q Electrical Characteristics

full-range  $T_A = -40^\circ\text{C}$  to  $125^\circ\text{C}$  (unless otherwise noted)

PARAMETER	TEST CONDITIONS	$T_A$	LM4041C12Q			LM4041D12Q			UNIT
			MIN	TYP	MAX	MIN	TYP	MAX	
$V_Z$	Reverse breakdown voltage	$I_Z = 100\ \mu\text{A}$	25°C			1.225			V
	Reverse breakdown voltage tolerance	$I_Z = 100\ \mu\text{A}$	25°C			-6                      6			mV
			Full range			-18.4                      18.4			
$I_{Z,\text{min}}$	Minimum cathode current		25°C			45                      75			$\mu\text{A}$
			Full range			80                      80			
$\alpha_{VZ}$	Average temperature coefficient of reverse breakdown voltage	$I_Z = 10\ \text{mA}$	25°C			$\pm 20$			ppm/°C
		$I_Z = 1\ \text{mA}$	25°C			$\pm 15$			
			Full range			$\pm 100$			
		$I_Z = 100\ \mu\text{A}$	25°C			$\pm 15$			
$\Delta V_Z/\Delta I_Z$	Reverse breakdown voltage change with cathode current change	$I_{Z,\text{min}} < I_Z < 1\ \text{mA}$	25°C			0.7                      1.5			mV
			Full range			2                      2.5			
		$1\ \text{mA} < I_Z < 12\ \text{mA}$	25°C			2.5                      6			
			Full range			8                      10			
$Z_Z$	Reverse dynamic impedance	$I_Z = 1\ \text{mA}$ , $f = 120\ \text{Hz}$ , $I_{AC} = 0.1 I_Z$	25°C			0.5                      0.5			$\Omega$
			Full range			1.5                      2			
$e_N$	Wideband noise	$I_Z = 100\ \mu\text{A}$ , $10\ \text{Hz} \leq f \leq 10\ \text{kHz}$	25°C			20                      20			$\mu\text{V}_{\text{RMS}}$
	Long-term stability of reverse breakdown voltage	$t = 1000\ \text{h}$ , $T_A = 25^\circ\text{C} \pm 0.1^\circ\text{C}$ , $I_Z = 100\ \mu\text{A}$	25°C			120                      120			ppm

# LM4041 PRECISION MICROPOWER SHUNT VOLTAGE REFERENCE

SLCS146E—FEBRUARY 2005—REVISED FEBRUARY 2006

## LM4041xl (Adjustable Version) Electrical Characteristics

full-range  $T_A = -40^\circ\text{C}$  to  $85^\circ\text{C}$  (unless otherwise noted)

PARAMETER	TEST CONDITIONS	$T_A$	LM4041BI			LM4041CI			UNIT
			MIN	TYP	MAX	MIN	TYP	MAX	
$V_{REF}$	Reference voltage	$I_Z = 100\ \mu\text{A}$ , $V_Z = 5\ \text{V}$	25°C			1.233			V
	Reference voltage tolerance <sup>(1)</sup>	$I_Z = 100\ \mu\text{A}$ , $V_Z = 5\ \text{V}$	25°C			-2.5      2.5			mV
			Full range			-10.5      10.5			
$I_{Z,min}$	Minimum cathode current		25°C			45      75			$\mu\text{A}$
			Full range			80      80			
$\Delta V_{REF}/\Delta I_Z$	Reference voltage change with cathode current change	$I_{Z,min} < I_Z < 1\ \text{mA}$	25°C			0.7      1.5			mV
			Full range			2      2			
		$1\ \text{mA} < I_Z < 12\ \text{mA}$	25°C			2      4			
			Full range			6      6			
$\Delta V_{REF}/\Delta V_{KA}$	Reference voltage change with output voltage change	$I_Z = 1\ \text{mA}$	25°C			-1.55      -2			mV/V
			Full range			-2.5      -2.5			
$I_{FB}$	Feedback current		25°C			60      100			nA
			Full range			120      120			
$\alpha V_{REF}$	Average temperature coefficient of reference voltage <sup>(1)</sup>	$I_Z = 10\ \text{mA}$ , $V_Z = 5\ \text{V}$	25°C			$\pm 20$			ppm/°C
		$I_Z = 1\ \text{mA}$ , $V_Z = 5\ \text{V}$	25°C			$\pm 15$			
			Full range			$\pm 100$			
		$I_Z = 100\ \mu\text{A}$ , $V_Z = 5\ \text{V}$	25°C			$\pm 15$			
$Z_Z$	Reverse dynamic impedance	$I_Z = 1\ \text{mA}$ , $f = 120\ \text{Hz}$ , $I_{AC} = 0.1\ I_Z$ , $V_Z = V_{REF}$	25°C			0.3			$\Omega$
		$I_Z = 1\ \text{mA}$ , $f = 120\ \text{Hz}$ , $I_{AC} = 0.1\ I_Z$ , $V_Z = 10\ \text{V}$	25°C			2			
$e_N$	Wideband noise	$I_Z = 100\ \mu\text{A}$ , $V_Z = V_{REF}$ , $10\ \text{Hz} \leq f \leq 10\ \text{kHz}$	25°C			20			$\mu\text{V}_{RMS}$
	Long-term stability of reverse breakdown voltage	$t = 1000\ \text{h}$ , $T_A = 25^\circ\text{C} \pm 0.1^\circ\text{C}$ , $I_Z = 100\ \mu\text{A}$	25°C			120			ppm

(1) Reference voltage tolerance and average temperature coefficient change with output voltage ( $V_Z$ ). See *Typical Characteristics*.



### LM4041xl (Adjustable Version) Electrical Characteristics

full-range  $T_A = -40^\circ\text{C}$  to  $85^\circ\text{C}$  (unless otherwise noted)

PARAMETER	TEST CONDITIONS	$T_A$	LM4041DI			UNIT
			MIN	TYP	MAX	
$V_{REF}$	Reference voltage	$I_Z = 100\ \mu\text{A}$ , $V_Z = 5\ \text{V}$	25°C	1.233		V
	Reference voltage tolerance <sup>(1)</sup>	$I_Z = 100\ \mu\text{A}$ , $V_Z = 5\ \text{V}$	25°C	-12	12	mV
			Full range	-24	24	
$I_{Z,min}$	Minimum cathode current		25°C	45	75	$\mu\text{A}$
			Full range		80	
$\Delta V_{REF}/\Delta I_Z$	Reference voltage change with cathode current change	$I_{Z,min} < I_Z < 1\ \text{mA}$	25°C	0.7	2	mV
			Full range		2.5	
		$1\ \text{mA} < I_Z < 12\ \text{mA}$	25°C	2	6	
			Full range		8	
$\Delta V_{REF}/\Delta V_{KA}$	Reference voltage change with output voltage change	$I_Z = 1\ \text{mA}$	25°C	-1.55	-2	mV/V
			Full range		-3	
$I_{FB}$	Feedback current		25°C	60	150	nA
			Full range		200	
$\alpha V_{REF}$	Average temperature coefficient of reference voltage <sup>(1)</sup>		$I_Z = 10\ \text{mA}$ , $V_Z = 5\ \text{V}$	25°C	$\pm 20$	ppm/°C
			$I_Z = 1\ \text{mA}$ , $V_Z = 5\ \text{V}$	25°C	$\pm 15$	
			Full range		$\pm 150$	
			$I_Z = 100\ \mu\text{A}$ , $V_Z = 5\ \text{V}$	25°C	$\pm 15$	
$Z_Z$	Reverse dynamic impedance		$I_Z = 1\ \text{mA}$ , $f = 120\ \text{Hz}$ , $I_{AC} = 0.1\ I_Z$ , $V_Z = V_{REF}$	25°C	0.3	$\Omega$
			$I_Z = 1\ \text{mA}$ , $f = 120\ \text{Hz}$ , $I_{AC} = 0.1\ I_Z$ , $V_Z = 10\ \text{V}$	25°C	2	
$e_N$	Wideband noise	$I_Z = 100\ \mu\text{A}$ , $V_Z = V_{REF}$ , $10\ \text{Hz} \leq f \leq 10\ \text{kHz}$	25°C	20		$\mu\text{V}_{RMS}$
	Long-term stability of reverse breakdown voltage	$t = 1000\ \text{h}$ , $T_A = 25^\circ\text{C} \pm 0.1^\circ\text{C}$ , $I_Z = 100\ \mu\text{A}$	25°C	120		ppm

(1) Reference voltage tolerance and average temperature coefficient change with output voltage ( $V_Z$ ). See *Typical Characteristics*.

# LM4041

## PRECISION MICROPOWER SHUNT VOLTAGE REFERENCE

SLCS146E—FEBRUARY 2005—REVISED FEBRUARY 2006

### LM4041xQ (Adjustable Version) Electrical Characteristics

full-range  $T_A = -40^\circ\text{C}$  to  $125^\circ\text{C}$  (unless otherwise noted)

PARAMETER	TEST CONDITIONS	$T_A$	LM4041CQ			LM4041DQ			UNIT
			MIN	TYP	MAX	MIN	TYP	MAX	
$V_{REF}$	Reference voltage	$I_Z = 100\ \mu\text{A}$ , $V_Z = 5\ \text{V}$	25°C			1.233			V
	Reference voltage tolerance <sup>(1)</sup>	$I_Z = 100\ \mu\text{A}$ , $V_Z = 5\ \text{V}$	25°C			-6.2      6.2			mV
			Full range			-18      18			
$I_{Z,min}$	Minimum cathode current		25°C			45      75			$\mu\text{A}$
			Full range			80      80			
$\Delta V_{REF}/\Delta I_Z$	Reference voltage change with cathode current change	$I_{Z,min} < I_Z < 1\ \text{mA}$	25°C			0.7      1.5			mV
			Full range			2      2.5			
		$1\ \text{mA} < I_Z < 12\ \text{mA}$	25°C			2      4			
			Full range			8      10			
$\Delta V_{REF}/\Delta V_{KA}$	Reference voltage change with output voltage change	$I_Z = 1\ \text{mA}$	25°C			-1.55      -2			mV/V
			Full range			-3      -4			
$I_{FB}$	Feedback current		25°C			60      100			nA
			Full range			120      200			
$\alpha V_{REF}$	Average temperature coefficient of reference voltage <sup>(1)</sup>	$I_Z = 10\ \text{mA}$ , $V_Z = 5\ \text{V}$	25°C			$\pm 20$			ppm/°C
			25°C			$\pm 15$			
		$I_Z = 1\ \text{mA}$ , $V_Z = 5\ \text{V}$	Full range			$\pm 100$			
			25°C			$\pm 15$			
$Z_Z$	Reverse dynamic impedance	$I_Z = 1\ \text{mA}$ , $f = 120\ \text{Hz}$ , $I_{AC} = 0.1\ I_Z$ , $V_Z = V_{REF}$	25°C			0.3			$\Omega$
			25°C			2			
$e_N$	Wideband noise	$I_Z = 100\ \mu\text{A}$ , $V_Z = V_{REF}$ , $10\ \text{Hz} \leq f \leq 10\ \text{kHz}$	25°C			20			$\mu\text{V}_{RMS}$
	Long-term stability of reverse breakdown voltage	$t = 1000\ \text{h}$ , $T_A = 25^\circ\text{C} \pm 0.1^\circ\text{C}$ , $I_Z = 100\ \mu\text{A}$	25°C			120			ppm

(1) Reference voltage tolerance and average temperature coefficient change with output voltage ( $V_Z$ ). See *Typical Characteristics*.

TYPICAL CHARACTERISTICS

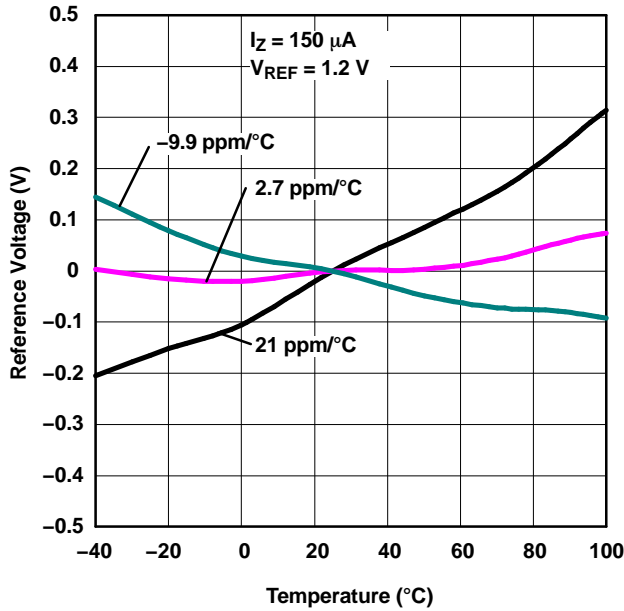

Figure 1. Temperature Drift for Different Average Temperature Coefficients

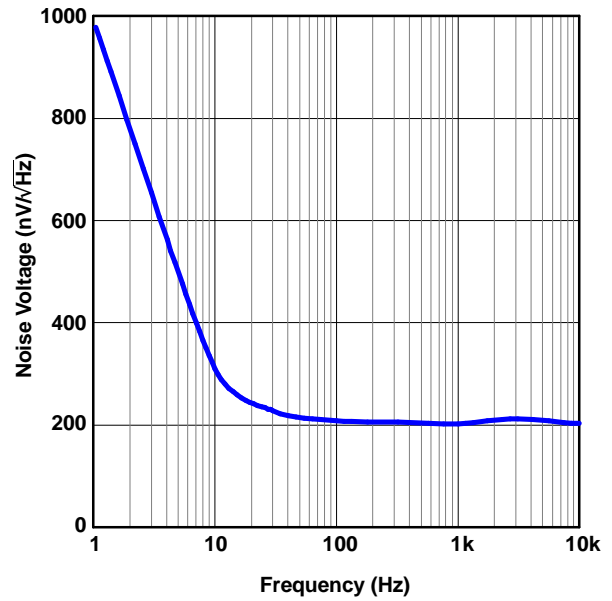

Figure 2. Noise Voltage vs Frequency

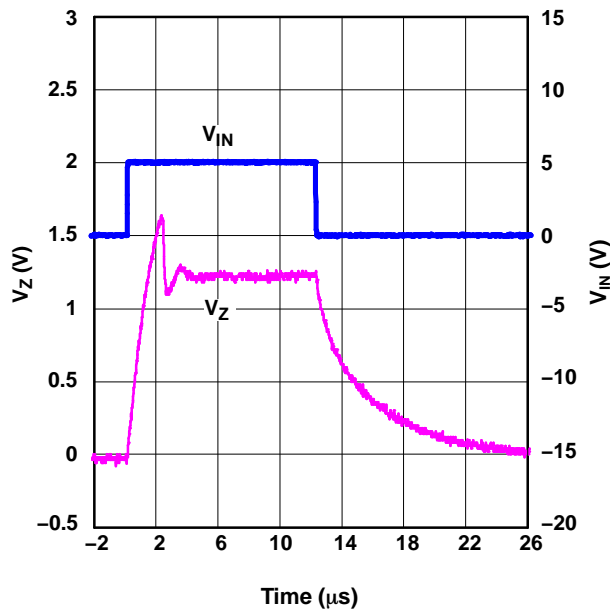

Figure 3. Start-Up Characteristics

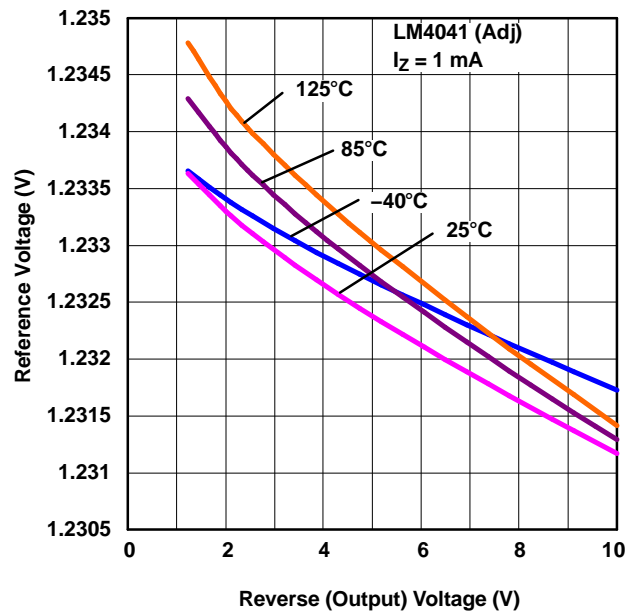

Figure 4. Reference Voltage vs Reverse (Output) Voltage (for Different Temperatures)

TYPICAL CHARACTERISTICS

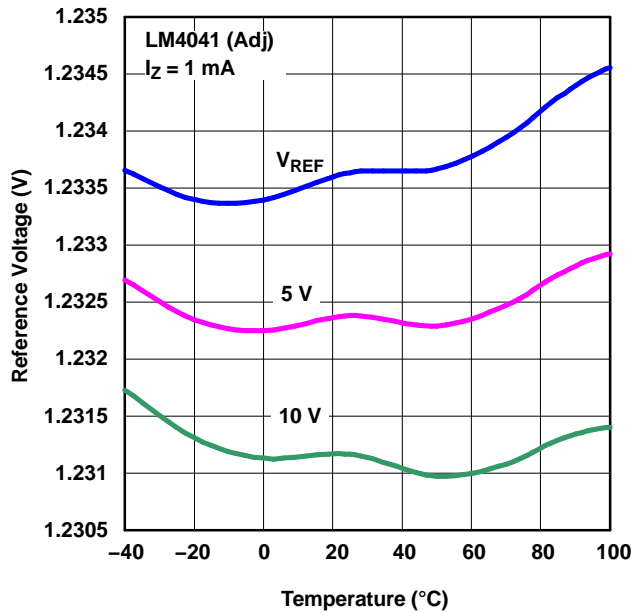

Figure 5. Reference Voltage vs Temperature (for Different Reverse Voltages)

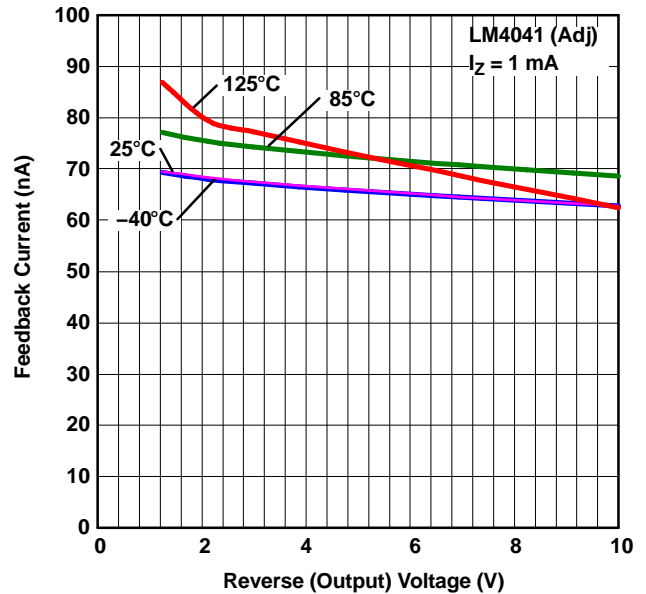

Figure 6. Feedback Current vs Reverse (Output) Voltage (for Different Temperatures)

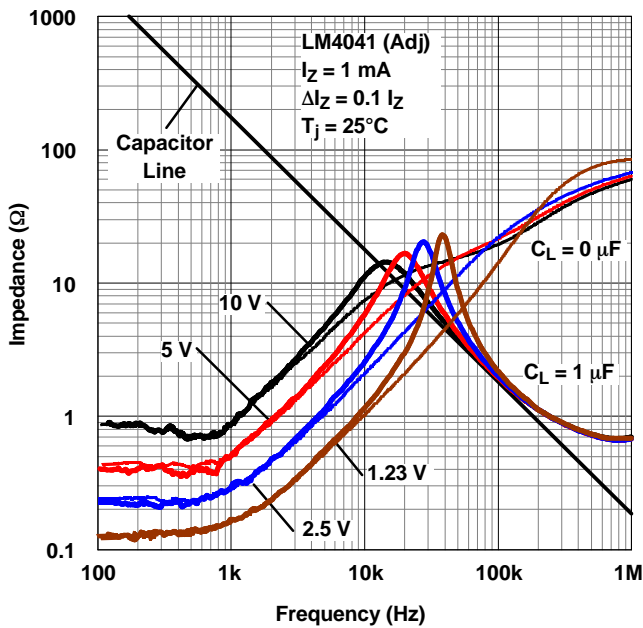

Figure 7. Output Impedance vs Frequency

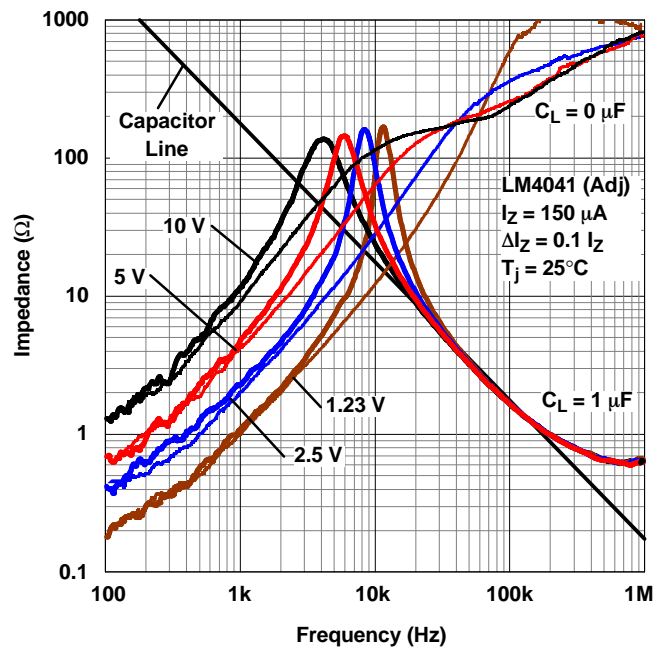

Figure 8. Output Impedance vs Frequency

**TYPICAL CHARACTERISTICS**



Figure 9. Reverse Characteristics

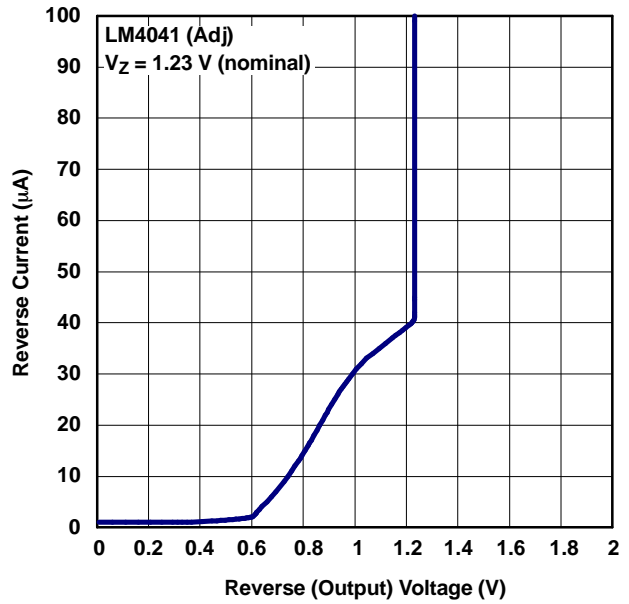

Figure 10. Reverse Characteristics and Minimum Operating Current

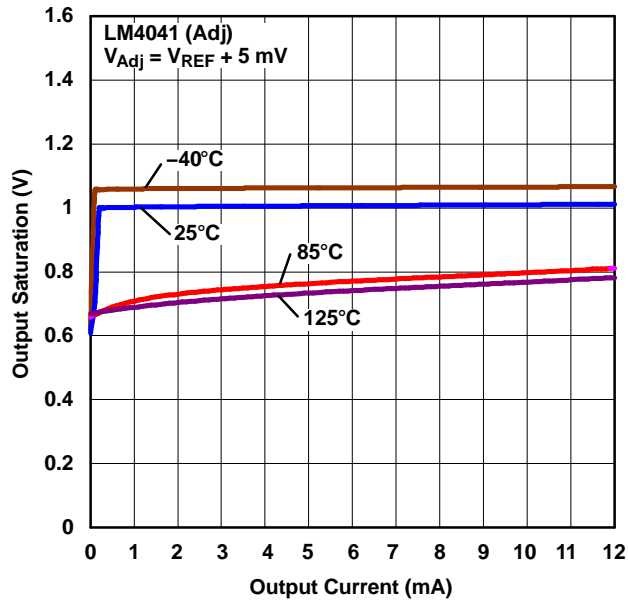
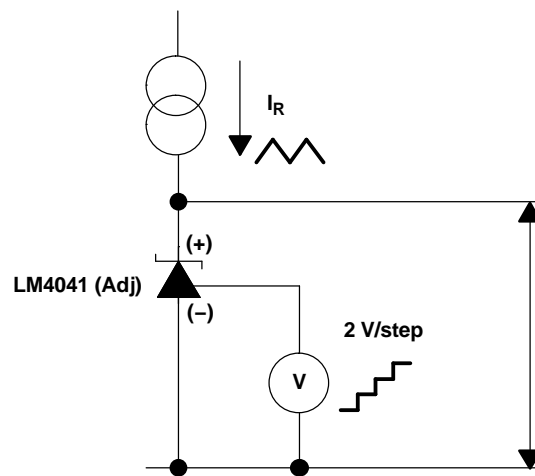

Figure 11. Output Saturation vs Output Current

**APPLICATION INFORMATION**



**Figure 12. Startup Characteristics Test Circuit**



**Figure 13. Reverse Characteristics Test Circuit**

**Output Capacitor**

The LM4041 does not require an output capacitor across CATHODE and ANODE for stability. However, if an output bypass capacitor is desired, the LM4041 is designed to be stable with all capacitive loads.

**SOT-23 and SC-70 Pin Connections**

There is a parasitic Schottky diode connected between pins 2 and 3 of the SOT-23 packaged device. Thus, pin 3 of the SOT-23 package must be left floating or connected to pin 2. Similarly, pin 2 of the SC-70 package also must be left floating or connected to pin 1.

## APPLICATION INFORMATION

### Adjustable Version

The adjustable version allows  $V_Z$  to be set by a user-defined resistor divider. The output voltage,  $V_Z$ , is set according to the equation shown in [Figure 14](#).

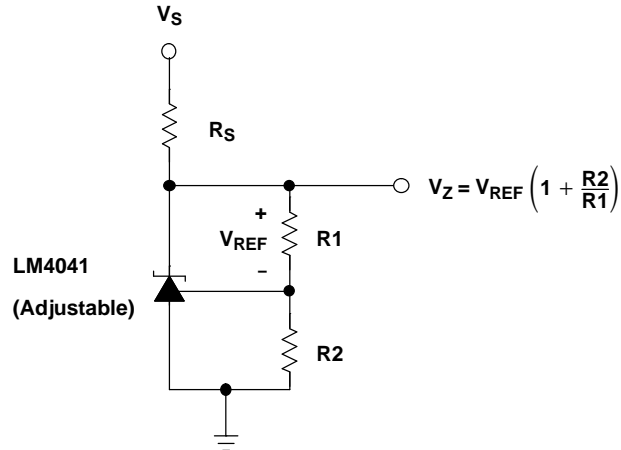

Figure 14. Adjustable Shunt Regulator

### Cathode and Load Currents

In a typical shunt regulator configuration (see [Figure 15](#)), an external resistor,  $R_S$ , is connected between the supply and the cathode of the LM4041.  $R_S$  must be set properly, as it sets the total current available to supply the load ( $I_L$ ) and bias the LM4041 ( $I_Z$ ). In all cases,  $I_Z$  must stay within a specified range for proper operation of the reference. Taking into consideration one extreme in the variation of the load and supply voltage (maximum  $I_L$  and minimum  $V_S$ ),  $R_S$  must be small enough to supply the minimum  $I_Z$  required for operation of the regulator, as given by data sheet parameters. At the other extreme, maximum  $V_S$  and minimum  $I_L$ ,  $R_S$  must be large enough to limit  $I_Z$  to less than its maximum recommended rating of 12 mA.

$R_S$  is calculated as shown in [Equation 1](#).

$$R_S = \frac{(V_S - V_Z)}{(I_L + I_Z)} \quad (1)$$



Figure 15. Shunt Regulator

**PACKAGING INFORMATION**

Orderable Device	Status <sup>(1)</sup>	Package Type	Package Drawing	Pins	Package Qty	Eco Plan <sup>(2)</sup>	Lead/Ball Finish	MSL Peak Temp <sup>(3)</sup>
LM4041A12IDBZR	ACTIVE	SOT-23	DBZ	3	3000	Green (RoHS & no Sb/Br)	CU NIPDAU	Level-1-260C-UNLIM
LM4041A12IDBZRG4	ACTIVE	SOT-23	DBZ	3	3000	Green (RoHS & no Sb/Br)	CU NIPDAU	Level-1-260C-UNLIM
LM4041A12IDBZT	ACTIVE	SOT-23	DBZ	3	250	Green (RoHS & no Sb/Br)	CU NIPDAU	Level-1-260C-UNLIM
LM4041A12IDBZTG4	ACTIVE	SOT-23	DBZ	3	250	Green (RoHS & no Sb/Br)	CU NIPDAU	Level-1-260C-UNLIM
LM4041A12IDCKR	ACTIVE	SC70	DCK	5	3000	Green (RoHS & no Sb/Br)	CU NIPDAU	Level-1-260C-UNLIM
LM4041A12IDCKRE4	ACTIVE	SC70	DCK	5	3000	Green (RoHS & no Sb/Br)	CU NIPDAU	Level-1-260C-UNLIM
LM4041A12IDCKRG4	ACTIVE	SC70	DCK	5	3000	Green (RoHS & no Sb/Br)	CU NIPDAU	Level-1-260C-UNLIM
LM4041A12ILP	PREVIEW	TO-92	LP	3	1000	TBD	Call TI	Call TI
LM4041B12IDBZR	ACTIVE	SOT-23	DBZ	3	3000	Green (RoHS & no Sb/Br)	CU NIPDAU	Level-1-260C-UNLIM
LM4041B12IDBZRG4	ACTIVE	SOT-23	DBZ	3	3000	Green (RoHS & no Sb/Br)	CU NIPDAU	Level-1-260C-UNLIM
LM4041B12IDBZT	ACTIVE	SOT-23	DBZ	3	250	Green (RoHS & no Sb/Br)	CU NIPDAU	Level-1-260C-UNLIM
LM4041B12IDBZTG4	ACTIVE	SOT-23	DBZ	3	250	Green (RoHS & no Sb/Br)	CU NIPDAU	Level-1-260C-UNLIM
LM4041B12IDCKR	ACTIVE	SC70	DCK	5	3000	Green (RoHS & no Sb/Br)	CU NIPDAU	Level-1-260C-UNLIM
LM4041B12IDCKRE4	ACTIVE	SC70	DCK	5	3000	Green (RoHS & no Sb/Br)	CU NIPDAU	Level-1-260C-UNLIM
LM4041B12IDCKRG4	ACTIVE	SC70	DCK	5	3000	Green (RoHS & no Sb/Br)	CU NIPDAU	Level-1-260C-UNLIM
LM4041B12ILP	PREVIEW	TO-92	LP	3	1000	TBD	Call TI	Call TI
LM4041BIDBZR	ACTIVE	SOT-23	DBZ	3	3000	Green (RoHS & no Sb/Br)	CU NIPDAU	Level-1-260C-UNLIM
LM4041BIDBZRG4	ACTIVE	SOT-23	DBZ	3	3000	Green (RoHS & no Sb/Br)	CU NIPDAU	Level-1-260C-UNLIM
LM4041BIDBZT	ACTIVE	SOT-23	DBZ	3	250	Green (RoHS & no Sb/Br)	CU NIPDAU	Level-1-260C-UNLIM
LM4041BIDBZTG4	ACTIVE	SOT-23	DBZ	3	250	Green (RoHS & no Sb/Br)	CU NIPDAU	Level-1-260C-UNLIM
LM4041BIDCKR	ACTIVE	SC70	DCK	5	3000	Green (RoHS & no Sb/Br)	CU NIPDAU	Level-1-260C-UNLIM
LM4041BIDCKRE4	ACTIVE	SC70	DCK	5	3000	Green (RoHS & no Sb/Br)	CU NIPDAU	Level-1-260C-UNLIM
LM4041BIDCKRG4	ACTIVE	SC70	DCK	5	3000	Green (RoHS & no Sb/Br)	CU NIPDAU	Level-1-260C-UNLIM
LM4041BIDCKT	ACTIVE	SC70	DCK	5	250	Green (RoHS & no Sb/Br)	CU NIPDAU	Level-1-260C-UNLIM
LM4041BIDCKTE4	ACTIVE	SC70	DCK	5	250	Green (RoHS & no Sb/Br)	CU NIPDAU	Level-1-260C-UNLIM
LM4041BIDCKTG4	ACTIVE	SC70	DCK	5	250	Green (RoHS & no Sb/Br)	CU NIPDAU	Level-1-260C-UNLIM



Orderable Device	Status <sup>(1)</sup>	Package Type	Package Drawing	Pins	Package Qty	Eco Plan <sup>(2)</sup>	Lead/Ball Finish	MSL Peak Temp <sup>(3)</sup>
						no Sb/Br)		
LM4041BILP	PREVIEW	TO-92	LP	3	1000	TBD	Call TI	Call TI
LM4041BILPR	PREVIEW	TO-92	LP	3	2000	TBD	Call TI	Call TI
LM4041C12IDBZR	ACTIVE	SOT-23	DBZ	3	3000	Green (RoHS & no Sb/Br)	CU NIPDAU	Level-1-260C-UNLIM
LM4041C12IDBZRG4	ACTIVE	SOT-23	DBZ	3	3000	Green (RoHS & no Sb/Br)	CU NIPDAU	Level-1-260C-UNLIM
LM4041C12IDBZT	ACTIVE	SOT-23	DBZ	3	250	Green (RoHS & no Sb/Br)	CU NIPDAU	Level-1-260C-UNLIM
LM4041C12IDBZTG4	ACTIVE	SOT-23	DBZ	3	250	Green (RoHS & no Sb/Br)	CU NIPDAU	Level-1-260C-UNLIM
LM4041C12IDCKR	ACTIVE	SC70	DCK	5	3000	Green (RoHS & no Sb/Br)	CU NIPDAU	Level-1-260C-UNLIM
LM4041C12IDCKRE4	ACTIVE	SC70	DCK	5	3000	Green (RoHS & no Sb/Br)	CU NIPDAU	Level-1-260C-UNLIM
LM4041C12IDCKRG4	ACTIVE	SC70	DCK	5	3000	Green (RoHS & no Sb/Br)	CU NIPDAU	Level-1-260C-UNLIM
LM4041C12ILP	ACTIVE	TO-92	LP	3	1000	Pb-Free (RoHS)	CU SN	N / A for Pkg Type
LM4041C12ILPE3	ACTIVE	TO-92	LP	3	1000	Pb-Free (RoHS)	CU SN	N / A for Pkg Type
LM4041C12ILPR	ACTIVE	TO-92	LP	3	2000	Pb-Free (RoHS)	CU SN	N / A for Pkg Type
LM4041C12ILPRE3	ACTIVE	TO-92	LP	3	2000	Pb-Free (RoHS)	CU SN	N / A for Pkg Type
LM4041C12QDBZR	ACTIVE	SOT-23	DBZ	3	3000	Green (RoHS & no Sb/Br)	CU NIPDAU	Level-1-260C-UNLIM
LM4041C12QDBZRG4	ACTIVE	SOT-23	DBZ	3	3000	Green (RoHS & no Sb/Br)	CU NIPDAU	Level-1-260C-UNLIM
LM4041C12QDBZT	ACTIVE	SOT-23	DBZ	3	250	Green (RoHS & no Sb/Br)	CU NIPDAU	Level-1-260C-UNLIM
LM4041C12QDBZTG4	ACTIVE	SOT-23	DBZ	3	250	Green (RoHS & no Sb/Br)	CU NIPDAU	Level-1-260C-UNLIM
LM4041CIDBZR	ACTIVE	SOT-23	DBZ	3	3000	Green (RoHS & no Sb/Br)	CU NIPDAU	Level-1-260C-UNLIM
LM4041CIDBZRG4	ACTIVE	SOT-23	DBZ	3	3000	Green (RoHS & no Sb/Br)	CU NIPDAU	Level-1-260C-UNLIM
LM4041CIDBZT	ACTIVE	SOT-23	DBZ	3	250	Green (RoHS & no Sb/Br)	CU NIPDAU	Level-1-260C-UNLIM
LM4041CIDBZTG4	ACTIVE	SOT-23	DBZ	3	250	Green (RoHS & no Sb/Br)	CU NIPDAU	Level-1-260C-UNLIM
LM4041CIDCKR	ACTIVE	SC70	DCK	5	3000	Green (RoHS & no Sb/Br)	CU NIPDAU	Level-1-260C-UNLIM
LM4041CIDCKRE4	ACTIVE	SC70	DCK	5	3000	Green (RoHS & no Sb/Br)	CU NIPDAU	Level-1-260C-UNLIM
LM4041CIDCKRG4	ACTIVE	SC70	DCK	5	3000	Green (RoHS & no Sb/Br)	CU NIPDAU	Level-1-260C-UNLIM
LM4041CIDCKT	ACTIVE	SC70	DCK	5	250	Green (RoHS & no Sb/Br)	CU NIPDAU	Level-1-260C-UNLIM
LM4041CIDCKTE4	ACTIVE	SC70	DCK	5	250	Green (RoHS & no Sb/Br)	CU NIPDAU	Level-1-260C-UNLIM

Orderable Device	Status <sup>(1)</sup>	Package Type	Package Drawing	Pins	Package Qty	Eco Plan <sup>(2)</sup>	Lead/Ball Finish	MSL Peak Temp <sup>(3)</sup>
LM4041CIDCKTG4	ACTIVE	SC70	DCK	5	250	Green (RoHS & no Sb/Br)	CU NIPDAU	Level-1-260C-UNLIM
LM4041CILP	ACTIVE	TO-92	LP	3	1000	Pb-Free (RoHS)	CU SN	N / A for Pkg Type
LM4041CILPE3	ACTIVE	TO-92	LP	3	1000	Pb-Free (RoHS)	CU SN	N / A for Pkg Type
LM4041CILPR	ACTIVE	TO-92	LP	3	2000	Pb-Free (RoHS)	CU SN	N / A for Pkg Type
LM4041CILPRE3	ACTIVE	TO-92	LP	3	2000	Pb-Free (RoHS)	CU SN	N / A for Pkg Type
LM4041CQDBZR	ACTIVE	SOT-23	DBZ	3	3000	Green (RoHS & no Sb/Br)	CU NIPDAU	Level-1-260C-UNLIM
LM4041CQDBZRG4	ACTIVE	SOT-23	DBZ	3	3000	Green (RoHS & no Sb/Br)	CU NIPDAU	Level-1-260C-UNLIM
LM4041CQDBZT	ACTIVE	SOT-23	DBZ	3	250	Green (RoHS & no Sb/Br)	CU NIPDAU	Level-1-260C-UNLIM
LM4041CQDBZTG4	ACTIVE	SOT-23	DBZ	3	250	Green (RoHS & no Sb/Br)	CU NIPDAU	Level-1-260C-UNLIM
LM4041D12IDBZR	ACTIVE	SOT-23	DBZ	3	3000	Green (RoHS & no Sb/Br)	CU NIPDAU	Level-1-260C-UNLIM
LM4041D12IDBZRG4	ACTIVE	SOT-23	DBZ	3	3000	Green (RoHS & no Sb/Br)	CU NIPDAU	Level-1-260C-UNLIM
LM4041D12IDBZT	ACTIVE	SOT-23	DBZ	3	250	Green (RoHS & no Sb/Br)	CU NIPDAU	Level-1-260C-UNLIM
LM4041D12IDBZTG4	ACTIVE	SOT-23	DBZ	3	250	Green (RoHS & no Sb/Br)	CU NIPDAU	Level-1-260C-UNLIM
LM4041D12IDCKR	ACTIVE	SC70	DCK	5	3000	Green (RoHS & no Sb/Br)	CU NIPDAU	Level-1-260C-UNLIM
LM4041D12IDCKRE4	ACTIVE	SC70	DCK	5	3000	Green (RoHS & no Sb/Br)	CU NIPDAU	Level-1-260C-UNLIM
LM4041D12IDCKRG4	ACTIVE	SC70	DCK	5	3000	Green (RoHS & no Sb/Br)	CU NIPDAU	Level-1-260C-UNLIM
LM4041D12ILP	ACTIVE	TO-92	LP	3	1000	Pb-Free (RoHS)	CU SN	N / A for Pkg Type
LM4041D12ILPE3	ACTIVE	TO-92	LP	3	1000	Pb-Free (RoHS)	CU SN	N / A for Pkg Type
LM4041D12ILPR	ACTIVE	TO-92	LP	3	2000	Pb-Free (RoHS)	CU SN	N / A for Pkg Type
LM4041D12ILPRE3	ACTIVE	TO-92	LP	3	2000	Pb-Free (RoHS)	CU SN	N / A for Pkg Type
LM4041D12QDBZR	ACTIVE	SOT-23	DBZ	3	3000	Green (RoHS & no Sb/Br)	CU NIPDAU	Level-1-260C-UNLIM
LM4041D12QDBZRG4	ACTIVE	SOT-23	DBZ	3	3000	Green (RoHS & no Sb/Br)	CU NIPDAU	Level-1-260C-UNLIM
LM4041D12QDBZT	ACTIVE	SOT-23	DBZ	3	250	Green (RoHS & no Sb/Br)	CU NIPDAU	Level-1-260C-UNLIM
LM4041D12QDBZTG4	ACTIVE	SOT-23	DBZ	3	250	Green (RoHS & no Sb/Br)	CU NIPDAU	Level-1-260C-UNLIM
LM4041DIDBZR	ACTIVE	SOT-23	DBZ	3	3000	Green (RoHS & no Sb/Br)	CU NIPDAU	Level-1-260C-UNLIM
LM4041DIDBZRG4	ACTIVE	SOT-23	DBZ	3	3000	Green (RoHS & no Sb/Br)	CU NIPDAU	Level-1-260C-UNLIM

Orderable Device	Status <sup>(1)</sup>	Package Type	Package Drawing	Pins	Package Qty	Eco Plan <sup>(2)</sup>	Lead/Ball Finish	MSL Peak Temp <sup>(3)</sup>
LM4041DIDBZT	ACTIVE	SOT-23	DBZ	3	250	Green (RoHS & no Sb/Br)	CU NIPDAU	Level-1-260C-UNLIM
LM4041DIDBZTG4	ACTIVE	SOT-23	DBZ	3	250	Green (RoHS & no Sb/Br)	CU NIPDAU	Level-1-260C-UNLIM
LM4041DIDCKR	ACTIVE	SC70	DCK	5	3000	Green (RoHS & no Sb/Br)	CU NIPDAU	Level-1-260C-UNLIM
LM4041DIDCKRE4	ACTIVE	SC70	DCK	5	3000	Green (RoHS & no Sb/Br)	CU NIPDAU	Level-1-260C-UNLIM
LM4041DIDCKRG4	ACTIVE	SC70	DCK	5	3000	Green (RoHS & no Sb/Br)	CU NIPDAU	Level-1-260C-UNLIM
LM4041DIDCKT	ACTIVE	SC70	DCK	5	250	Green (RoHS & no Sb/Br)	CU NIPDAU	Level-1-260C-UNLIM
LM4041DIDCKTE4	ACTIVE	SC70	DCK	5	250	Green (RoHS & no Sb/Br)	CU NIPDAU	Level-1-260C-UNLIM
LM4041DIDCKTG4	ACTIVE	SC70	DCK	5	250	Green (RoHS & no Sb/Br)	CU NIPDAU	Level-1-260C-UNLIM
LM4041DILP	ACTIVE	TO-92	LP	3	1000	Pb-Free (RoHS)	CU SN	N / A for Pkg Type
LM4041DILPE3	ACTIVE	TO-92	LP	3	1000	Pb-Free (RoHS)	CU SN	N / A for Pkg Type
LM4041DILPR	ACTIVE	TO-92	LP	3	2000	Pb-Free (RoHS)	CU SN	N / A for Pkg Type
LM4041DILPRE3	ACTIVE	TO-92	LP	3	2000	Pb-Free (RoHS)	CU SN	N / A for Pkg Type
LM4041DQDBZR	ACTIVE	SOT-23	DBZ	3	3000	Green (RoHS & no Sb/Br)	CU NIPDAU	Level-1-260C-UNLIM
LM4041DQDBZRG4	ACTIVE	SOT-23	DBZ	3	3000	Green (RoHS & no Sb/Br)	CU NIPDAU	Level-1-260C-UNLIM
LM4041DQDBZT	ACTIVE	SOT-23	DBZ	3	250	Green (RoHS & no Sb/Br)	CU NIPDAU	Level-1-260C-UNLIM
LM4041DQDBZTG4	ACTIVE	SOT-23	DBZ	3	250	Green (RoHS & no Sb/Br)	CU NIPDAU	Level-1-260C-UNLIM

<sup>(1)</sup> The marketing status values are defined as follows:

**ACTIVE:** Product device recommended for new designs.

**LIFEBUY:** TI has announced that the device will be discontinued, and a lifetime-buy period is in effect.

**NRND:** Not recommended for new designs. Device is in production to support existing customers, but TI does not recommend using this part in a new design.

**PREVIEW:** Device has been announced but is not in production. Samples may or may not be available.

**OBSELETE:** TI has discontinued the production of the device.

<sup>(2)</sup> Eco Plan - The planned eco-friendly classification: Pb-Free (RoHS), Pb-Free (RoHS Exempt), or Green (RoHS & no Sb/Br) - please check <http://www.ti.com/productcontent> for the latest availability information and additional product content details.

**TBD:** The Pb-Free/Green conversion plan has not been defined.

**Pb-Free (RoHS):** TI's terms "Lead-Free" or "Pb-Free" mean semiconductor products that are compatible with the current RoHS requirements for all 6 substances, including the requirement that lead not exceed 0.1% by weight in homogeneous materials. Where designed to be soldered at high temperatures, TI Pb-Free products are suitable for use in specified lead-free processes.

**Pb-Free (RoHS Exempt):** This component has a RoHS exemption for either 1) lead-based flip-chip solder bumps used between the die and package, or 2) lead-based die adhesive used between the die and leadframe. The component is otherwise considered Pb-Free (RoHS compatible) as defined above.

**Green (RoHS & no Sb/Br):** TI defines "Green" to mean Pb-Free (RoHS compatible), and free of Bromine (Br) and Antimony (Sb) based flame retardants (Br or Sb do not exceed 0.1% by weight in homogeneous material)

<sup>(3)</sup> MSL, Peak Temp. -- The Moisture Sensitivity Level rating according to the JEDEC industry standard classifications, and peak solder temperature.

**Important Information and Disclaimer:**The information provided on this page represents TI's knowledge and belief as of the date that it is provided. TI bases its knowledge and belief on information provided by third parties, and makes no representation or warranty as to the accuracy of such information. Efforts are underway to better integrate information from third parties. TI has taken and continues to take reasonable steps to provide representative and accurate information but may not have conducted destructive testing or chemical analysis on incoming materials and chemicals. TI and TI suppliers consider certain information to be proprietary, and thus CAS numbers and other limited information may not be available for release.

In no event shall TI's liability arising out of such information exceed the total purchase price of the TI part(s) at issue in this document sold by TI to Customer on an annual basis.

**TAPE AND REEL INFORMATION**



**QUADRANT ASSIGNMENTS FOR PIN 1 ORIENTATION IN TAPE**



\*All dimensions are nominal

Device	Package Type	Package Drawing	Pins	SPQ	Reel Diameter (mm)	Reel Width W1 (mm)	A0 (mm)	B0 (mm)	K0 (mm)	P1 (mm)	W (mm)	Pin1 Quadrant
LM4041A12IDBZR	SOT-23	DBZ	3	3000	179.0	8.4	3.15	2.95	1.22	4.0	8.0	Q3
LM4041A12IDBZT	SOT-23	DBZ	3	250	179.0	8.4	3.15	2.95	1.22	4.0	8.0	Q3
LM4041A12IDCKR	SC70	DCK	5	3000	179.0	8.4	2.2	2.5	1.2	4.0	8.0	Q3
LM4041B12IDBZR	SOT-23	DBZ	3	3000	179.0	8.4	3.15	2.95	1.22	4.0	8.0	Q3
LM4041B12IDBZT	SOT-23	DBZ	3	250	179.0	8.4	3.15	2.95	1.22	4.0	8.0	Q3
LM4041B12IDCKR	SC70	DCK	5	3000	179.0	8.4	2.2	2.5	1.2	4.0	8.0	Q3
LM4041BIDBZR	SOT-23	DBZ	3	3000	179.0	8.4	3.15	2.95	1.22	4.0	8.0	Q3
LM4041BIDBZT	SOT-23	DBZ	3	250	179.0	8.4	3.15	2.95	1.22	4.0	8.0	Q3
LM4041BIDCKR	SC70	DCK	5	3000	179.0	8.4	2.2	2.5	1.2	4.0	8.0	Q3
LM4041BIDCKT	SC70	DCK	5	250	179.0	8.4	2.2	2.5	1.2	4.0	8.0	Q3
LM4041C12IDBZR	SOT-23	DBZ	3	3000	179.0	8.4	3.15	2.95	1.22	4.0	8.0	Q3
LM4041C12IDBZT	SOT-23	DBZ	3	250	179.0	8.4	3.15	2.95	1.22	4.0	8.0	Q3
LM4041C12IDCKR	SC70	DCK	5	3000	179.0	8.4	2.2	2.5	1.2	4.0	8.0	Q3
LM4041C12QDBZR	SOT-23	DBZ	3	3000	179.0	8.4	3.15	2.95	1.22	4.0	8.0	Q3
LM4041C12QDBZT	SOT-23	DBZ	3	250	179.0	8.4	3.15	2.95	1.22	4.0	8.0	Q3
LM4041CIDBZR	SOT-23	DBZ	3	3000	179.0	8.4	3.15	2.95	1.22	4.0	8.0	Q3
LM4041CIDBZT	SOT-23	DBZ	3	250	179.0	8.4	3.15	2.95	1.22	4.0	8.0	Q3
LM4041CIDCKR	SC70	DCK	5	3000	179.0	8.4	2.2	2.5	1.2	4.0	8.0	Q3

Device	Package Type	Package Drawing	Pins	SPQ	Reel Diameter (mm)	Reel Width W1 (mm)	A0 (mm)	B0 (mm)	K0 (mm)	P1 (mm)	W (mm)	Pin1 Quadrant
LM4041CIDCKT	SC70	DCK	5	250	179.0	8.4	2.2	2.5	1.2	4.0	8.0	Q3
LM4041CQDBZR	SOT-23	DBZ	3	3000	179.0	8.4	3.15	2.95	1.22	4.0	8.0	Q3
LM4041CQDBZT	SOT-23	DBZ	3	250	179.0	8.4	3.15	2.95	1.22	4.0	8.0	Q3
LM4041D12IDBZR	SOT-23	DBZ	3	3000	179.0	8.4	3.15	2.95	1.22	4.0	8.0	Q3
LM4041D12IDBZT	SOT-23	DBZ	3	250	179.0	8.4	3.15	2.95	1.22	4.0	8.0	Q3
LM4041D12IDCKR	SC70	DCK	5	3000	179.0	8.4	2.2	2.5	1.2	4.0	8.0	Q3
LM4041D12QDBZR	SOT-23	DBZ	3	3000	179.0	8.4	3.15	2.95	1.22	4.0	8.0	Q3
LM4041D12QDBZT	SOT-23	DBZ	3	250	179.0	8.4	3.15	2.95	1.22	4.0	8.0	Q3
LM4041DIDBZR	SOT-23	DBZ	3	3000	179.0	8.4	3.15	2.95	1.22	4.0	8.0	Q3
LM4041DIDBZT	SOT-23	DBZ	3	250	179.0	8.4	3.15	2.95	1.22	4.0	8.0	Q3
LM4041DIDCKR	SC70	DCK	5	3000	179.0	8.4	2.2	2.5	1.2	4.0	8.0	Q3
LM4041DIDCKT	SC70	DCK	5	250	179.0	8.4	2.2	2.5	1.2	4.0	8.0	Q3
LM4041DQDBZR	SOT-23	DBZ	3	3000	179.0	8.4	3.15	2.95	1.22	4.0	8.0	Q3
LM4041DQDBZT	SOT-23	DBZ	3	250	179.0	8.4	3.15	2.95	1.22	4.0	8.0	Q3

**TAPE AND REEL BOX DIMENSIONS**

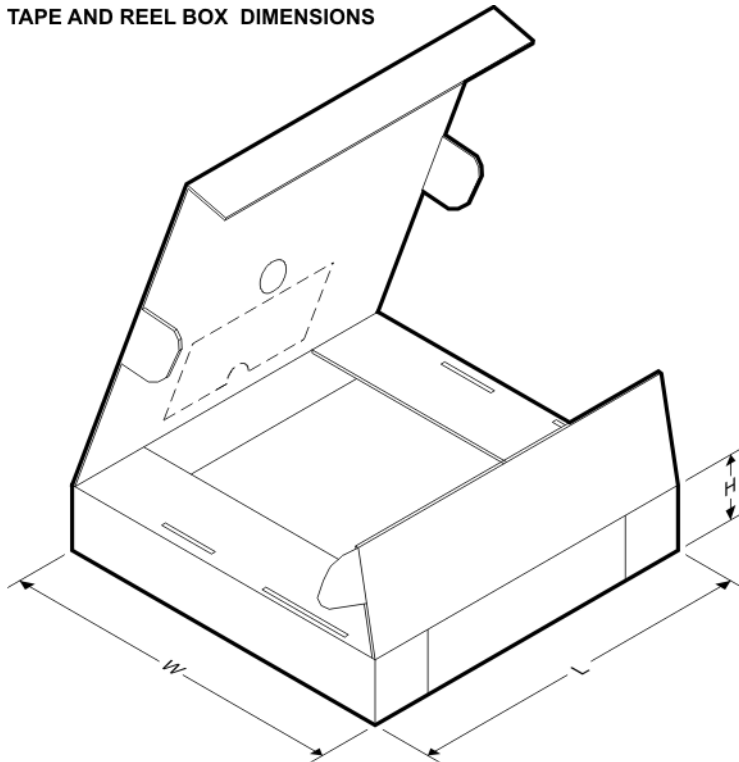

\*All dimensions are nominal

Device	Package Type	Package Drawing	Pins	SPQ	Length (mm)	Width (mm)	Height (mm)
LM4041A12IDBZR	SOT-23	DBZ	3	3000	195.0	200.0	45.0
LM4041A12IDBZT	SOT-23	DBZ	3	250	195.0	200.0	45.0
LM4041A12IDCKR	SC70	DCK	5	3000	195.0	200.0	45.0

Device	Package Type	Package Drawing	Pins	SPQ	Length (mm)	Width (mm)	Height (mm)
LM4041B12IDBZR	SOT-23	DBZ	3	3000	195.0	200.0	45.0
LM4041B12IDBZT	SOT-23	DBZ	3	250	195.0	200.0	45.0
LM4041B12IDCKR	SC70	DCK	5	3000	195.0	200.0	45.0
LM4041BIDBZR	SOT-23	DBZ	3	3000	195.0	200.0	45.0
LM4041BIDBZT	SOT-23	DBZ	3	250	195.0	200.0	45.0
LM4041BIDCKR	SC70	DCK	5	3000	195.0	200.0	45.0
LM4041BIDCKT	SC70	DCK	5	250	195.0	200.0	45.0
LM4041C12IDBZR	SOT-23	DBZ	3	3000	195.0	200.0	45.0
LM4041C12IDBZT	SOT-23	DBZ	3	250	195.0	200.0	45.0
LM4041C12IDCKR	SC70	DCK	5	3000	195.0	200.0	45.0
LM4041C12QDBZR	SOT-23	DBZ	3	3000	195.0	200.0	45.0
LM4041C12QDBZT	SOT-23	DBZ	3	250	195.0	200.0	45.0
LM4041CIDBZR	SOT-23	DBZ	3	3000	195.0	200.0	45.0
LM4041CIDBZT	SOT-23	DBZ	3	250	195.0	200.0	45.0
LM4041CIDCKR	SC70	DCK	5	3000	195.0	200.0	45.0
LM4041CIDCKT	SC70	DCK	5	250	195.0	200.0	45.0
LM4041CQDBZR	SOT-23	DBZ	3	3000	195.0	200.0	45.0
LM4041CQDBZT	SOT-23	DBZ	3	250	195.0	200.0	45.0
LM4041D12IDBZR	SOT-23	DBZ	3	3000	220.0	205.0	50.0
LM4041D12IDBZT	SOT-23	DBZ	3	250	195.0	200.0	45.0
LM4041D12IDCKR	SC70	DCK	5	3000	195.0	200.0	45.0
LM4041D12QDBZR	SOT-23	DBZ	3	3000	195.0	200.0	45.0
LM4041D12QDBZT	SOT-23	DBZ	3	250	195.0	200.0	45.0
LM4041DIDBZR	SOT-23	DBZ	3	3000	195.0	200.0	45.0
LM4041DIDBZT	SOT-23	DBZ	3	250	195.0	200.0	45.0
LM4041DIDCKR	SC70	DCK	5	3000	195.0	200.0	45.0
LM4041DIDCKT	SC70	DCK	5	250	195.0	200.0	45.0
LM4041DQDBZR	SOT-23	DBZ	3	3000	195.0	200.0	45.0
LM4041DQDBZT	SOT-23	DBZ	3	250	195.0	200.0	45.0

DCK (R-PDSO-G5)

PLASTIC SMALL-OUTLINE PACKAGE



- NOTES:
- A. All linear dimensions are in millimeters.
  - B. This drawing is subject to change without notice.
  - C. Body dimensions do not include mold flash or protrusion. Mold flash and protrusion shall not exceed 0.15 per side.
  - D. Falls within JEDEC MO-203 variation AA.



DBZ (R-PDSO-G3)

PLASTIC SMALL-OUTLINE



- NOTES:
- A. All linear dimensions are in millimeters. Dimensioning and tolerancing per ASME Y14.5M-1994.
  - B. This drawing is subject to change without notice.
  - C. Lead dimensions are inclusive of plating.
  - D. Body dimensions are exclusive of mold flash and protrusion. Mold flash and protrusion not to exceed 0.25 per side.
  - Falls within JEDEC TO-236 variation AB, except minimum foot length.

LP (O-PBCY-W3)

PLASTIC CYLINDRICAL PACKAGE

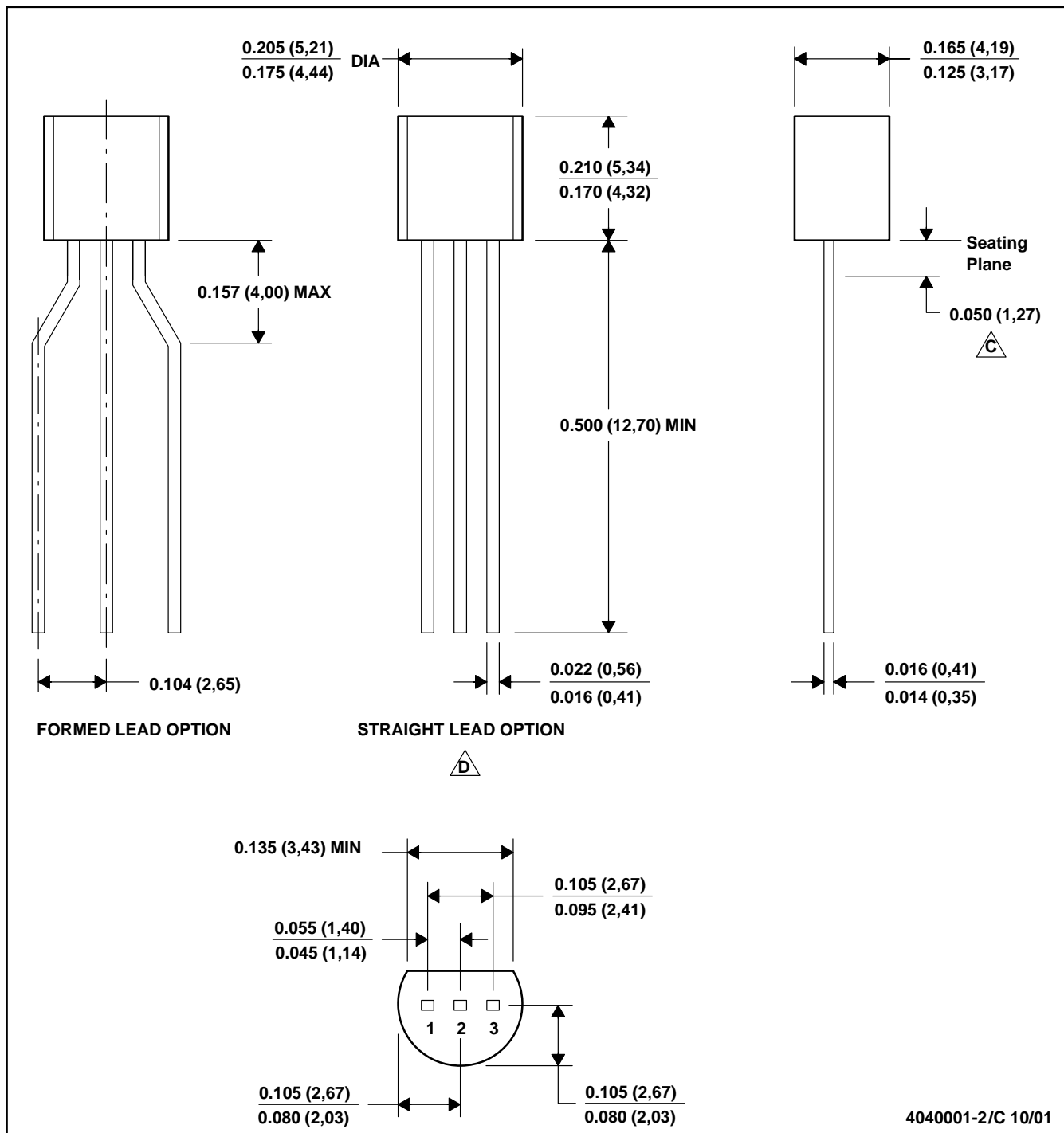

4040001-2/C 10/01

- NOTES: A. All linear dimensions are in inches (millimeters).  
 B. This drawing is subject to change without notice.  
 C. Lead dimensions are not controlled within this area  
 D. Falls within JEDEC TO -226 Variation AA (TO-226 replaces TO-92)  
 E. Shipping Method:  
 Straight lead option available in bulk pack only.  
 Formed lead option available in tape & reel or ammo pack.



# MECHANICAL DATA

MSOT002A – OCTOBER 1994 – REVISED NOVEMBER 2001

LP (O-PBCY-W3)

PLASTIC CYLINDRICAL PACKAGE

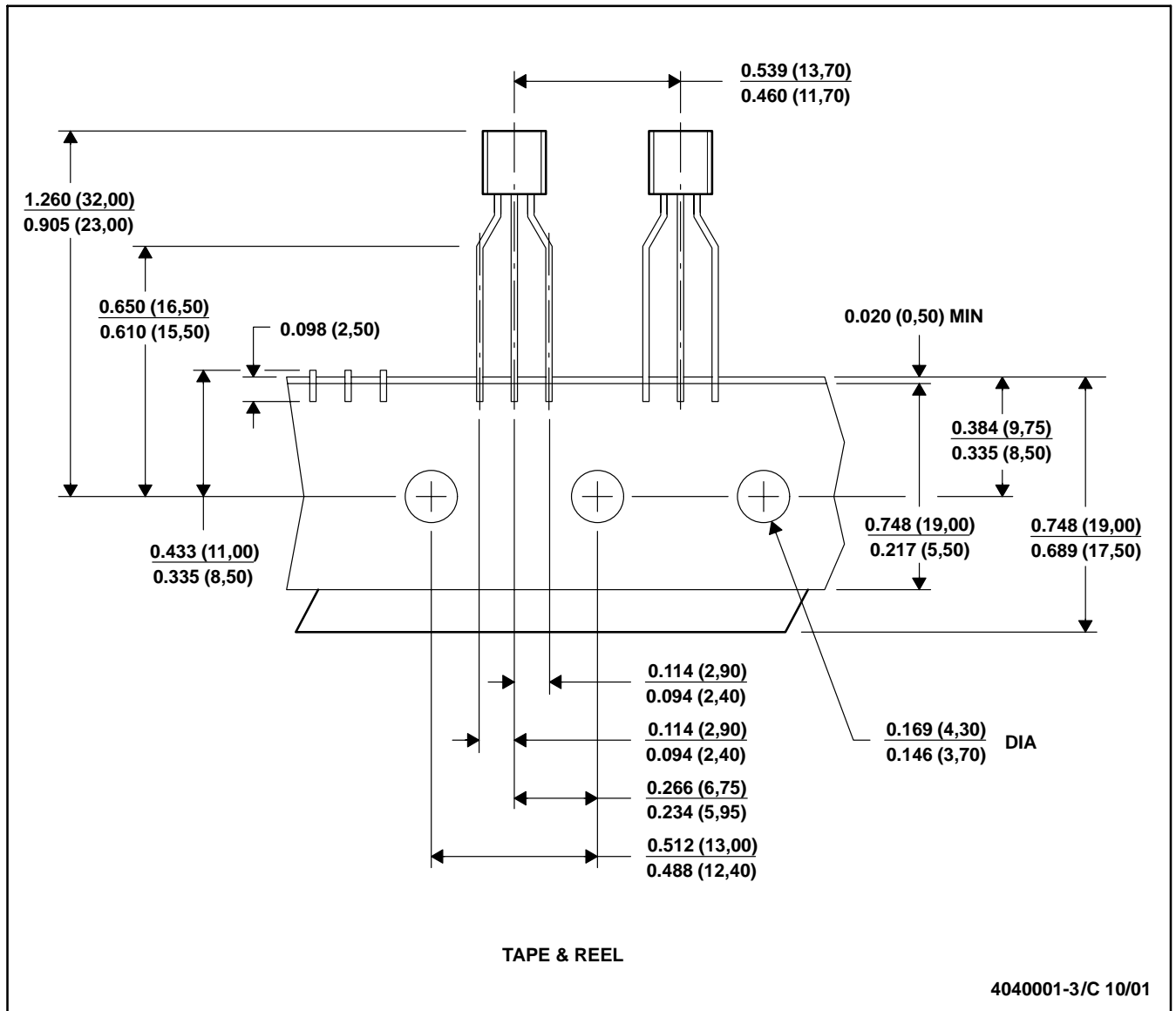

- NOTES: A. All linear dimensions are in inches (millimeters).  
 B. This drawing is subject to change without notice.  
 C. Tape and Reel information for the Format Lead Option package.

## IMPORTANT NOTICE

Texas Instruments Incorporated and its subsidiaries (TI) reserve the right to make corrections, modifications, enhancements, improvements, and other changes to its products and services at any time and to discontinue any product or service without notice. Customers should obtain the latest relevant information before placing orders and should verify that such information is current and complete. All products are sold subject to TI's terms and conditions of sale supplied at the time of order acknowledgment.

TI warrants performance of its hardware products to the specifications applicable at the time of sale in accordance with TI's standard warranty. Testing and other quality control techniques are used to the extent TI deems necessary to support this warranty. Except where mandated by government requirements, testing of all parameters of each product is not necessarily performed.

TI assumes no liability for applications assistance or customer product design. Customers are responsible for their products and applications using TI components. To minimize the risks associated with customer products and applications, customers should provide adequate design and operating safeguards.

TI does not warrant or represent that any license, either express or implied, is granted under any TI patent right, copyright, mask work right, or other TI intellectual property right relating to any combination, machine, or process in which TI products or services are used. Information published by TI regarding third-party products or services does not constitute a license from TI to use such products or services or a warranty or endorsement thereof. Use of such information may require a license from a third party under the patents or other intellectual property of the third party, or a license from TI under the patents or other intellectual property of TI.

Reproduction of TI information in TI data books or data sheets is permissible only if reproduction is without alteration and is accompanied by all associated warranties, conditions, limitations, and notices. Reproduction of this information with alteration is an unfair and deceptive business practice. TI is not responsible or liable for such altered documentation. Information of third parties may be subject to additional restrictions.

Resale of TI products or services with statements different from or beyond the parameters stated by TI for that product or service voids all express and any implied warranties for the associated TI product or service and is an unfair and deceptive business practice. TI is not responsible or liable for any such statements.

TI products are not authorized for use in safety-critical applications (such as life support) where a failure of the TI product would reasonably be expected to cause severe personal injury or death, unless officers of the parties have executed an agreement specifically governing such use. Buyers represent that they have all necessary expertise in the safety and regulatory ramifications of their applications, and acknowledge and agree that they are solely responsible for all legal, regulatory and safety-related requirements concerning their products and any use of TI products in such safety-critical applications, notwithstanding any applications-related information or support that may be provided by TI. Further, Buyers must fully indemnify TI and its representatives against any damages arising out of the use of TI products in such safety-critical applications.

TI products are neither designed nor intended for use in military/aerospace applications or environments unless the TI products are specifically designated by TI as military-grade or "enhanced plastic." Only products designated by TI as military-grade meet military specifications. Buyers acknowledge and agree that any such use of TI products which TI has not designated as military-grade is solely at the Buyer's risk, and that they are solely responsible for compliance with all legal and regulatory requirements in connection with such use.

TI products are neither designed nor intended for use in automotive applications or environments unless the specific TI products are designated by TI as compliant with ISO/TS 16949 requirements. Buyers acknowledge and agree that, if they use any non-designated products in automotive applications, TI will not be responsible for any failure to meet such requirements.

Following are URLs where you can obtain information on other Texas Instruments products and application solutions:

### Products

Amplifiers	<a href="http://amplifier.ti.com">amplifier.ti.com</a>
Data Converters	<a href="http://dataconverter.ti.com">dataconverter.ti.com</a>
DSP	<a href="http://dsp.ti.com">dsp.ti.com</a>
Clocks and Timers	<a href="http://www.ti.com/clocks">www.ti.com/clocks</a>
Interface	<a href="http://interface.ti.com">interface.ti.com</a>
Logic	<a href="http://logic.ti.com">logic.ti.com</a>
Power Mgmt	<a href="http://power.ti.com">power.ti.com</a>
Microcontrollers	<a href="http://microcontroller.ti.com">microcontroller.ti.com</a>
RFID	<a href="http://www.ti-rfid.com">www.ti-rfid.com</a>
RF/IF and ZigBee® Solutions	<a href="http://www.ti.com/lprf">www.ti.com/lprf</a>

### Applications

Audio	<a href="http://www.ti.com/audio">www.ti.com/audio</a>
Automotive	<a href="http://www.ti.com/automotive">www.ti.com/automotive</a>
Broadband	<a href="http://www.ti.com/broadband">www.ti.com/broadband</a>
Digital Control	<a href="http://www.ti.com/digitalcontrol">www.ti.com/digitalcontrol</a>
Medical	<a href="http://www.ti.com/medical">www.ti.com/medical</a>
Military	<a href="http://www.ti.com/military">www.ti.com/military</a>
Optical Networking	<a href="http://www.ti.com/opticalnetwork">www.ti.com/opticalnetwork</a>
Security	<a href="http://www.ti.com/security">www.ti.com/security</a>
Telephony	<a href="http://www.ti.com/telephony">www.ti.com/telephony</a>
Video & Imaging	<a href="http://www.ti.com/video">www.ti.com/video</a>
Wireless	<a href="http://www.ti.com/wireless">www.ti.com/wireless</a>

Mailing Address: Texas Instruments, Post Office Box 655303, Dallas, Texas 75265  
Copyright © 2008, Texas Instruments Incorporated