

Distributed by:

**JAMECO**<sup>®</sup>  
ELECTRONICS

**www.Jameco.com ♦ 1-800-831-4242**

The content and copyrights of the attached  
material are the property of its owner.

Jameco Part Number 1261579

# LM2937

## 500 mA Low Dropout Regulator

### General Description

The LM2937 is a positive voltage regulator capable of supplying up to 500 mA of load current. The use of a PNP power transistor provides a low dropout voltage characteristic. With a load current of 500 mA the minimum input to output voltage differential required for the output to remain in regulation is typically 0.5V (1V guaranteed maximum over the full operating temperature range). Special circuitry has been incorporated to minimize the quiescent current to typically only 10 mA with a full 500 mA load current when the input to output voltage differential is greater than 3V.

The LM2937 requires an output bypass capacitor for stability. As with most low dropout regulators, the ESR of this capacitor remains a critical design parameter, but the LM2937 includes special compensation circuitry that relaxes ESR requirements. The LM2937 is stable for all ESR below 3Ω. This allows the use of low ESR chip capacitors.

Ideally suited for automotive applications, the LM2937 will protect itself and any load circuitry from reverse battery

connections, two-battery jumps and up to +60V/-50V load dump transients. Familiar regulator features such as short circuit and thermal shutdown protection are also built in.

### Features

- Fully specified for operation over -40°C to +125°C
- Output current in excess of 500 mA
- Output trimmed for 5% tolerance under all operating conditions
- Typical dropout voltage of 0.5V at full rated load current
- Wide output capacitor ESR range, up to 3Ω
- Internal short circuit and thermal overload protection
- Reverse battery protection
- 60V input transient protection
- Mirror image insertion protection

### Connection Diagrams

TO-220 Plastic Package

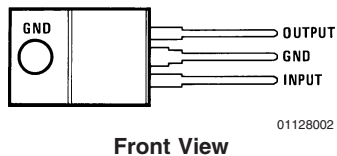

SOT-223 Plastic Package

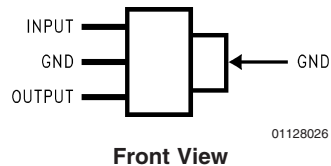

TO-263 Surface-Mount Package

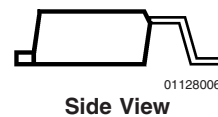
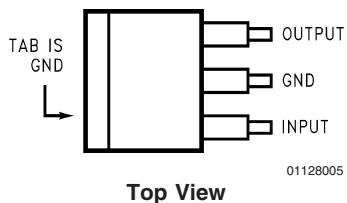

## Ordering Information

Package	Temperature Range	Part Number	Packaging Marking	Transport Media	NSC Drawing
TO-263	$-40^{\circ}\text{C} \leq T_J \leq 125^{\circ}\text{C}$	LM2937ES-5.0	LM2937ES-5.0	Rail	TS3B
		LM2937ESX-5.0		500 Units Tape and Reel	
		LM2937ES-8.0	LM2937ES-8.0	Rail	
		LM2937ESX-8.0		500 Units Tape and Reel	
		LM2937ES-10	LM2937ES-10	Rail	
		LM2937ESX-10		500 Units Tape and Reel	
		LM2937ES-12	LM2937ES-12	Rail	
		LM2937ESX-12		500 Units Tape and Reel	
		LM2937ES-15	LM2937ES-15	Rail	
LM2937ESX-15	500 Units Tape and Reel				
TO-220	$-40^{\circ}\text{C} \leq T_J \leq 125^{\circ}\text{C}$	LM2937ET-5.0	LM2937ET-5.0	Rail	TO3B
		LM2937ET-8.0	LM2937ET-8.0	Rail	
		LM2937ET-10	LM2937ET-10	Rail	
		LM2937ET-12	LM2937ET-12	Rail	
		LM2937ET-15	LM2937ET-15	Rail	
SOT-223	$-40^{\circ}\text{C} \leq T_J \leq 85^{\circ}\text{C}$	LM2937IMP-5.0	L71B	1k Units Tape and Reel	MP04A
		LM2937IMPX-5.0		2k Units Tape and Reel	
		LM2937IMP-8.0	L72B	1k Units Tape and Reel	
		LM2937IMPX-8.0		2k Units Tape and Reel	
		LM2937IMP-10	L73B	1k Units Tape and Reel	
		LM2937IMPX-10		2k Units Tape and Reel	
		LM2937IMP-12	L74B	1k Units Tape and Reel	
		LM2937IMPX-12		2k Units Tape and Reel	
LM2937IMP-15	L75B	1k Units Tape and Reel			
LM2937IMPX-15		2k Units Tape and Reel			

**Absolute Maximum Ratings** (Note 1)

If Military/Aerospace specified devices are required, please contact the National Semiconductor Sales Office/Distributors for availability and specifications.

Input Voltage	
Continuous	26V
Transient ( $t \leq 100$ ms)	60V
Internal Power Dissipation (Note 2)	Internally Limited
Maximum Junction Temperature	150°C
Storage Temperature Range	-65°C to +150°C
TO-220 (10 seconds)	260°C

TO-263 (10 seconds)	230°C
SOT-223 (Vapor Phase, 60 seconds)	215°C
SOT-223 (Infrared, 15 seconds)	220°C
ESD Susceptibility (Note 3)	2 kV

**Operating Conditions** (Note 1)

Temperature Range (Note 2)	
LM2937ET, LM2937ES	-40°C $\leq$ T <sub>J</sub> $\leq$ 125°C
LM2937IMP	-40°C $\leq$ T <sub>J</sub> $\leq$ 85°C
Maximum Input Voltage	26V

**Electrical Characteristics**

$V_{IN} = V_{NOM} + 5V$ , (Note 4)  $I_{OUTmax} = 500$  mA for the TO-220 and TO-263 packages,  $I_{OUTmax} = 400$  mA for the SOT-223 package,  $C_{OUT} = 10$   $\mu$ F unless otherwise indicated. **Boldface limits apply over the entire operating temperature range of the indicated device.**, all other specifications are for T<sub>A</sub> = T<sub>J</sub> = 25°C.

Output Voltage (V <sub>OUT</sub> )		5V		8V		10V		Units
Parameter	Conditions	Typ	Limit	Typ	Limit	Typ	Limit	
Output Voltage	$5 \text{ mA} \leq I_{OUT} \leq I_{OUTmax}$		4.85		7.76		9.70	V(Min)
		5.00	<b>4.75</b>	8.00	<b>7.60</b>	10.00	<b>9.50</b>	V(Min)
			5.15		8.24		10.30	V(Max)
			<b>5.25</b>		<b>8.40</b>		<b>10.50</b>	V(Max)
Line Regulation	$(V_{OUT} + 2V) \leq V_{IN} \leq 26V$ , $I_{OUT} = 5 \text{ mA}$	15	<b>50</b>	24	<b>80</b>	30	<b>100</b>	mV(Max)
Load Regulation	$5 \text{ mA} \leq I_{OUT} \leq I_{OUTmax}$	5	<b>50</b>	8	<b>80</b>	10	<b>100</b>	mV(Max)
Quiescent Current	$(V_{OUT} + 2V) \leq V_{IN} \leq 26V$ , $I_{OUT} = 5 \text{ mA}$	2	<b>10</b>	2	<b>10</b>	2	<b>10</b>	mA(Max)
	$V_{IN} = (V_{OUT} + 5V)$ , $I_{OUT} = I_{OUTmax}$	10	<b>20</b>	10	<b>20</b>	10	<b>20</b>	mA(Max)
Output Noise Voltage	10 Hz–100 kHz $I_{OUT} = 5 \text{ mA}$	150		240		300		$\mu$ Vrms
Long Term Stability	1000 Hrs.	20		32		40		mV
Dropout Voltage	$I_{OUT} = I_{OUTmax}$	0.5	<b>1.0</b>	0.5	<b>1.0</b>	0.5	<b>1.0</b>	V(Max)
	$I_{OUT} = 50 \text{ mA}$	110	<b>250</b>	110	<b>250</b>	110	<b>250</b>	mV(Max)
Short-Circuit Current		1.0	<b>0.6</b>	1.0	<b>0.6</b>	1.0	<b>0.6</b>	A(Min)
Peak Line Transient Voltage	$t_f < 100$ ms, $R_L = 100\Omega$	75	<b>60</b>	75	<b>60</b>	75	<b>60</b>	V(Min)
Maximum Operational Input Voltage			<b>26</b>		<b>26</b>		<b>26</b>	V(Min)
Reverse DC Input Voltage	$V_{OUT} \geq -0.6V$ , $R_L = 100\Omega$	-30	<b>-15</b>	-30	<b>-15</b>	-30	<b>-15</b>	V(Min)
Reverse Transient Input Voltage	$t_f < 1$ ms, $R_L = 100\Omega$	-75	<b>-50</b>	-75	<b>-50</b>	-75	<b>-50</b>	V(Min)

## Electrical Characteristics

$V_{IN} = V_{NOM} + 5V$ , (Note 4)  $I_{OUTmax} = 500\text{ mA}$  for the TO-220 and TO-263 packages,  $I_{OUTmax}=400\text{mA}$  for the SOT-223 package,  $C_{OUT} = 10\ \mu\text{F}$  unless otherwise indicated. **Boldface limits apply over the entire operating temperature range of the indicted device.**, all other specifications are for  $T_A = T_J = 25^\circ\text{C}$ .

Output Voltage ( $V_{OUT}$ )		12V		15V		Units
Parameter	Conditions	Typ	Limit	Typ	Limit	
Output Voltage	$5\text{ mA} \leq I_{OUT} \leq I_{OUTmax}$		11.64		14.55	V (Min)
		12.00	<b>11.40</b>	15.00	<b>14.25</b>	V(Min)
			12.36		15.45	V(Max)
			<b>12.60</b>		<b>15.75</b>	V(Max)
Line Regulation	$(V_{OUT} + 2V) \leq V_{IN} \leq 26V$ , $I_{OUT} = 5\text{ mA}$	36	<b>120</b>	45	<b>150</b>	mV(Max)
Load Regulation	$5\text{ mA} \leq I_{OUT} \leq I_{OUTmax}$	12	<b>120</b>	15	<b>150</b>	mV(Max)
Quiescent Current	$(V_{OUT} + 2V) \leq V_{IN} \leq 26V$ , $I_{OUT} = 5\text{ mA}$	2	<b>10</b>	2	<b>10</b>	mA(Max)
		$V_{IN} = (V_{OUT} + 5V)$ , $I_{OUT} = I_{OUTmax}$	10	<b>20</b>	10	<b>20</b>
Output Noise Voltage	10 Hz–100 kHz, $I_{OUT} = 5\text{ mA}$	360		450		$\mu\text{Vrms}$
Long Term Stability	1000 Hrs.	44		56		mV
Dropout Voltage	$I_{OUT} = I_{OUTmax}$	0.5	<b>1.0</b>	0.5	<b>1.0</b>	V(Max)
	$I_{OUT} = 50\text{ mA}$	110	<b>250</b>	110	<b>250</b>	mV(Max)
Short-Circuit Current		1.0	<b>0.6</b>	1.0	<b>0.6</b>	A(Min)
Peak Line Transient Voltage	$t_f < 100\text{ ms}$ , $R_L = 100\Omega$	75	<b>60</b>	75	<b>60</b>	V(Min)
Maximum Operational Input Voltage			<b>26</b>		<b>26</b>	V(Min)
Reverse DC Input Voltage	$V_{OUT} \geq -0.6V$ , $R_L = 100\Omega$	-30	<b>-15</b>	-30	<b>-15</b>	V(Min)
Reverse Transient Input Voltage	$t_r < 1\text{ ms}$ , $R_L = 100\Omega$	-75	<b>-50</b>	-75	<b>-50</b>	V(Min)

**Note 1:** Absolute Maximum Ratings indicate limits beyond which damage to the device may occur. Electrical specifications do not apply when operating the device outside of its rated Operating Conditions.

**Note 2:** The maximum allowable power dissipation at any ambient temperature is  $P_{MAX} = (125 - T_A)/\theta_{JA}$ , where 125 is the maximum junction temperature for operation,  $T_A$  is the ambient temperature, and  $\theta_{JA}$  is the junction-to-ambient thermal resistance. If this dissipation is exceeded, the die temperature will rise above  $125^\circ\text{C}$  and the electrical specifications do not apply. If the die temperature rises above  $150^\circ\text{C}$ , the LM2937 will go into thermal shutdown. For the LM2937, the junction-to-ambient thermal resistance  $\theta_{JA}$  is  $65^\circ\text{C/W}$ , for the TO-220 package,  $73^\circ\text{C/W}$  for the TO-263 package, and  $174^\circ\text{C/W}$  for the SOT-223 package. When used with a heatsink,  $\theta_{JA}$  is the sum of the LM2937 junction-to-case thermal resistance  $\theta_{JC}$  of  $3^\circ\text{C/W}$  and the heatsink case-to-ambient thermal resistance. If the TO-263 or SOT-223 packages are used, the thermal resistance can be reduced by increasing the P.C. board copper area thermally connected to the package (see Application Hints for more information on heatsinking).

**Note 3:** ESD rating is based on the human body model, 100 pF discharged through 1.5 k $\Omega$ .

**Note 4:** Typicals are at  $T_J = 25^\circ\text{C}$  and represent the most likely parametric norm.

# Typical Performance Characteristics

**Dropout Voltage vs. Output Current**

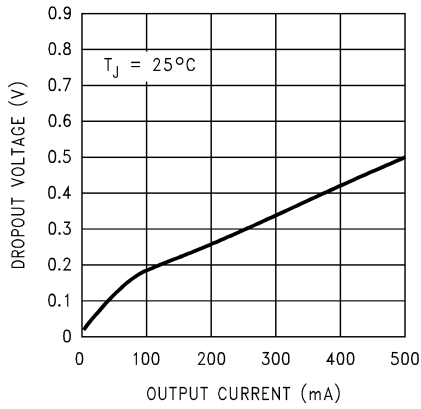

01128007

**Dropout Voltage vs. Temperature**

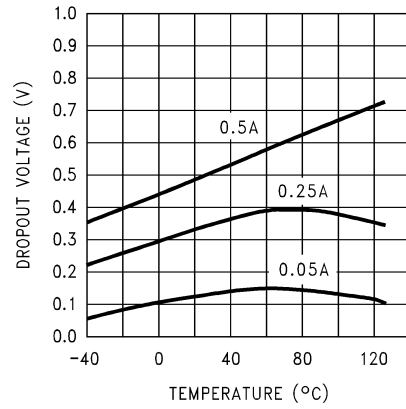

01128008

**Output Voltage vs. Temperature**

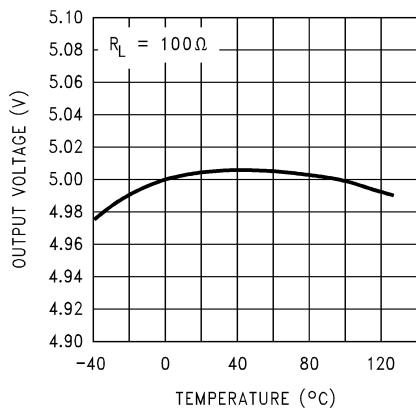

01128009

**Quiescent Current vs. Temperature**

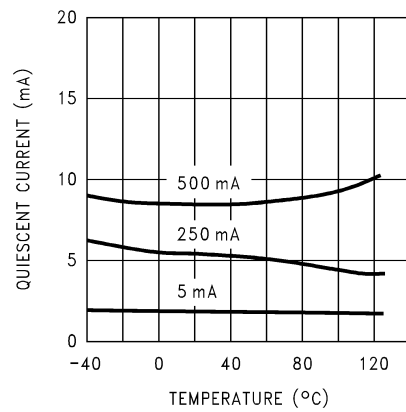

01128010

**Quiescent Current vs. Input Voltage**

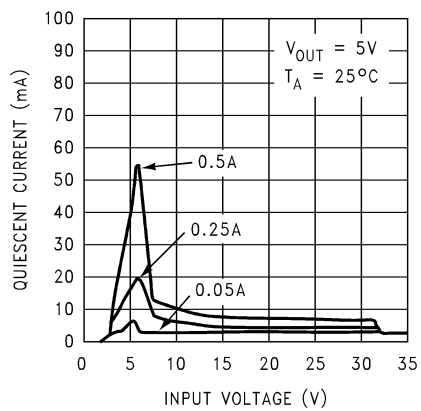

01128011

**Quiescent Current vs. Output Current**

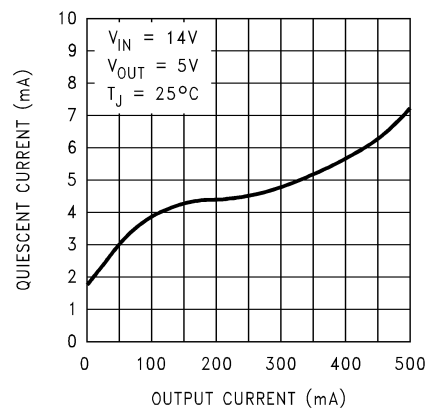

01128012

# Typical Performance Characteristics (Continued)

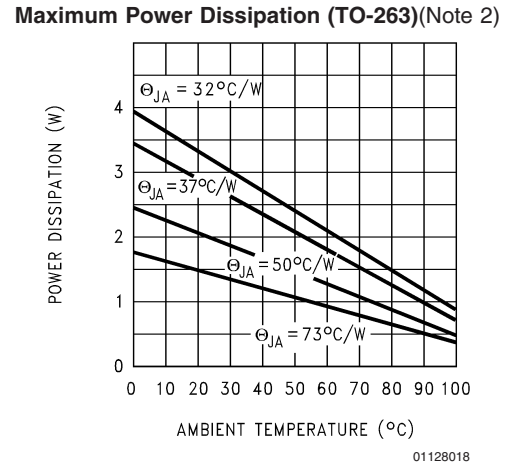
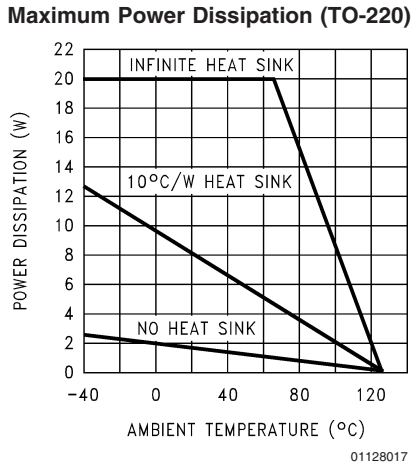
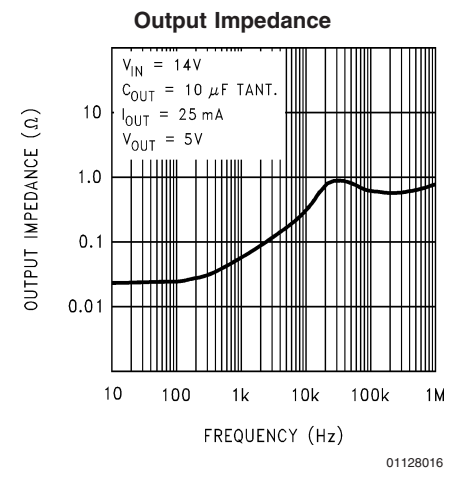
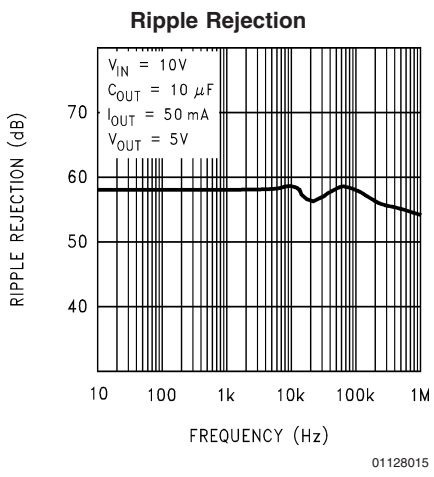
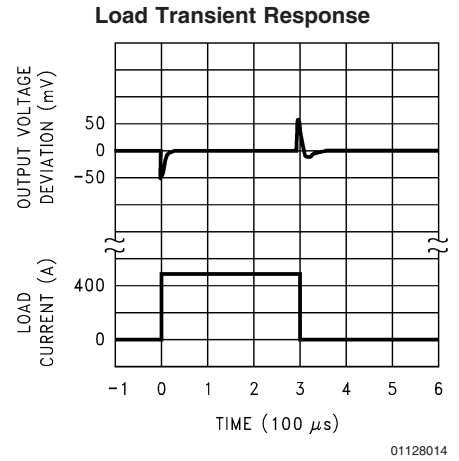
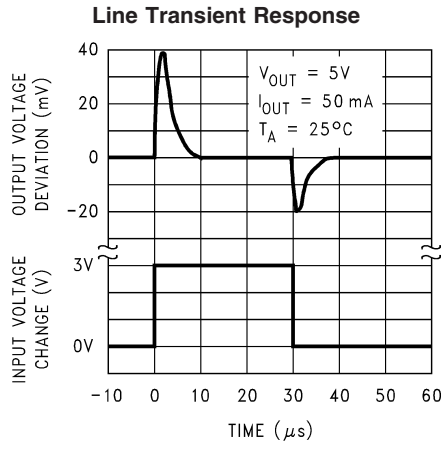

Typical Performance Characteristics (Continued)

Low Voltage Behavior

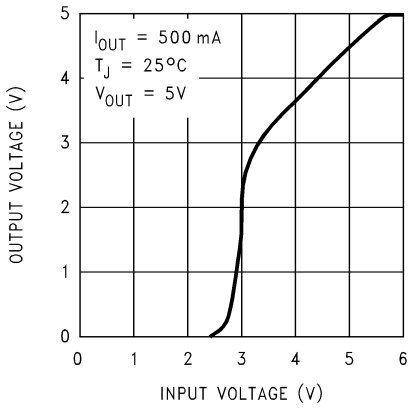

01128019

Low Voltage Behavior

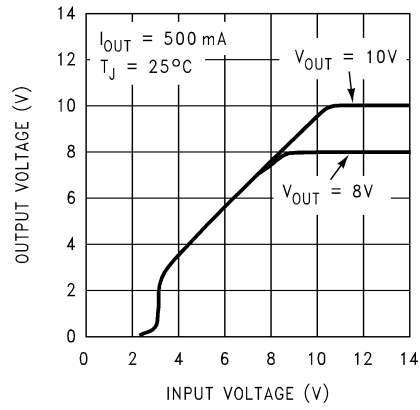

01128020

Low Voltage Behavior

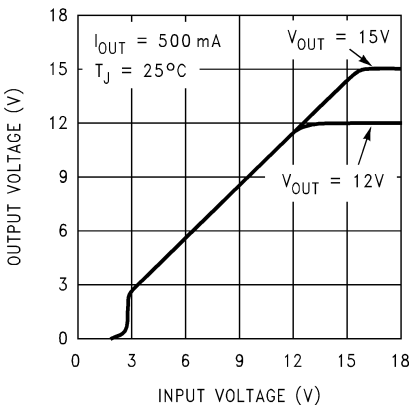

01128021

Output at Voltage Extremes

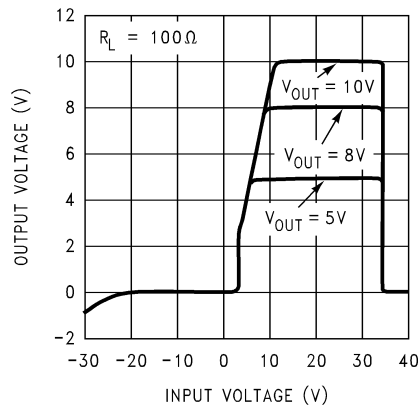

01128022

Output at Voltage Extremes

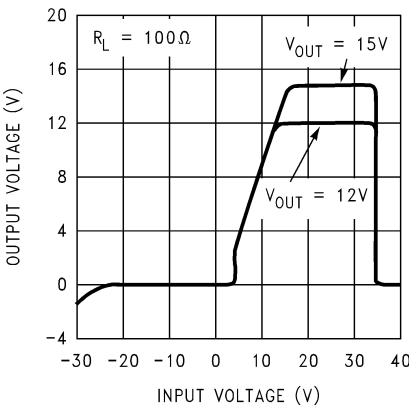

01128023

Output Capacitor ESR

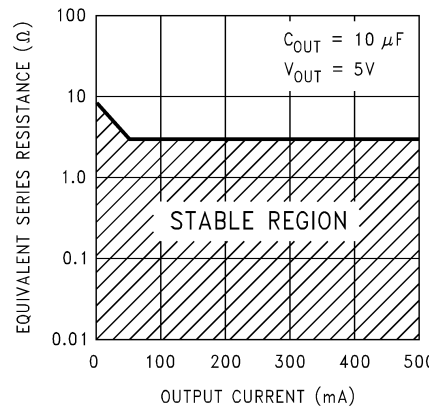

01128024



## Typical Performance Characteristics (Continued)

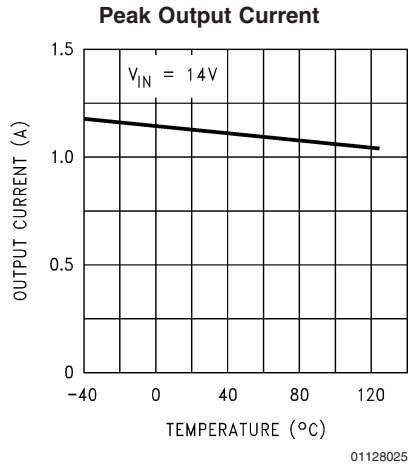

## Typical Application

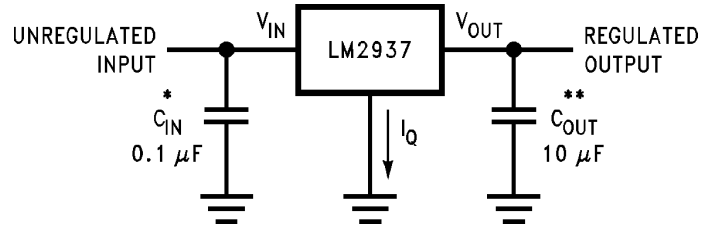

\* Required if the regulator is located more than 3 inches from the power supply filter capacitors.

\*\* Required for stability.  $C_{OUT}$  must be at least 10  $\mu F$  (over the full expected operating temperature range) and located as close as possible to the regulator. The equivalent series resistance, ESR, of this capacitor may be as high as 3 $\Omega$ .

## Application Hints

### EXTERNAL CAPACITORS

The output capacitor is critical to maintaining regulator stability, and must meet the required conditions for both ESR (Equivalent Series Resistance) and minimum amount of capacitance.

#### MINIMUM CAPACITANCE:

The minimum output capacitance required to maintain stability is 10  $\mu\text{F}$  (this value may be increased without limit). Larger values of output capacitance will give improved transient response.

#### ESR LIMITS:

The ESR of the output capacitor will cause loop instability if it is too high or too low. The acceptable range of ESR plotted versus load current is shown in the graph below. **It is essential that the output capacitor meet these requirements, or oscillations can result.**

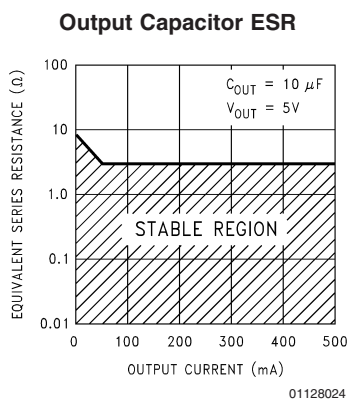

FIGURE 1. ESR Limits

It is important to note that for most capacitors, ESR is specified only at room temperature. However, the designer must ensure that the ESR will stay inside the limits shown over the entire operating temperature range for the design.

For aluminum electrolytic capacitors, ESR will increase by about 30X as the temperature is reduced from 25°C to -40°C. This type of capacitor is not well-suited for low temperature operation.

Solid tantalum capacitors have a more stable ESR over temperature, but are more expensive than aluminum electrolytics. A cost-effective approach sometimes used is to parallel an aluminum electrolytic with a solid Tantalum, with the total capacitance split about 75/25% with the Aluminum being the larger value.

If two capacitors are paralleled, the effective ESR is the parallel of the two individual values. The "flatter" ESR of the Tantalum will keep the effective ESR from rising as quickly at low temperatures.

### HEATSINKING

A heatsink may be required depending on the maximum power dissipation and maximum ambient temperature of the application. Under all possible operating conditions, the junction temperature must be within the range specified under Absolute Maximum Ratings.

To determine if a heatsink is required, the power dissipated by the regulator,  $P_D$ , must be calculated.

The figure below shows the voltages and currents which are present in the circuit, as well as the formula for calculating the power dissipated in the regulator:

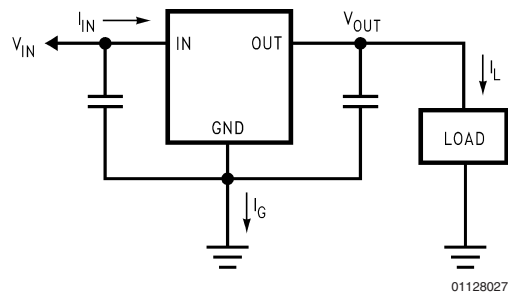

$$I_{IN} = I_L + I_G$$

$$P_D = (V_{IN} - V_{OUT}) I_L + (V_{IN}) I_G$$

FIGURE 2. Power Dissipation Diagram

The next parameter which must be calculated is the maximum allowable temperature rise,  $T_R$  (max). This is calculated by using the formula:

$$T_R (\text{max}) = T_J (\text{max}) - T_A (\text{max})$$

where:  $T_J$  (max) is the maximum allowable junction temperature, which is 125°C for commercial grade parts.

$T_A$  (max) is the maximum ambient temperature which will be encountered in the application.

Using the calculated values for  $T_R$ (max) and  $P_D$ , the maximum allowable value for the junction-to-ambient thermal resistance,  $\theta_{(J-A)}$ , can now be found:

$$\theta_{(J-A)} = T_R (\text{max})/P_D$$

**IMPORTANT:** If the maximum allowable value for  $\theta_{(J-A)}$  is found to be  $\geq 53^\circ\text{C/W}$  for the TO-220 package,  $\geq 80^\circ\text{C/W}$  for the TO-263 package, or  $\geq 174^\circ\text{C/W}$  for the SOT-223 package, no heatsink is needed since the package alone will dissipate enough heat to satisfy these requirements.

If the calculated value for  $\theta_{(J-A)}$  falls below these limits, a heatsink is required.

### HEATSINKING TO-220 PACKAGE PARTS

The TO-220 can be attached to a typical heatsink, or secured to a copper plane on a PC board. If a copper plane is to be used, the values of  $\theta_{(J-A)}$  will be the same as shown in the next section for the TO-263.

If a manufactured heatsink is to be selected, the value of heatsink-to-ambient thermal resistance,  $\theta_{(H-A)}$ , must first be calculated:

$$\theta_{(H-A)} = \theta_{(J-A)} - \theta_{(C-H)} - \theta_{(J-C)}$$

Where:  $\theta_{(J-C)}$  is defined as the thermal resistance from the junction to the surface of the case. A value of 3°C/W can be assumed for  $\theta_{(J-C)}$  for this calculation.

$\theta_{(C-H)}$  is defined as the thermal resistance between the case and the surface of the heatsink. The value of  $\theta_{(C-H)}$  will vary from about 1.5°C/W to about 2.5°C/W (depending on method of attachment, insulator, etc.). If the exact value is unknown, 2°C/W should be assumed for  $\theta_{(C-H)}$ .

## Application Hints (Continued)

When a value for  $\theta_{(H-A)}$  is found using the equation shown, a heatsink must be selected that has a value that is less than or equal to this number.

$\theta_{(H-A)}$  is specified numerically by the heatsink manufacturer in the catalog, or shown in a curve that plots temperature rise vs power dissipation for the heatsink.

### HEATSINKING TO-263 AND SOT-223 PACKAGE PARTS

Both the TO-263 ("S") and SOT-223 ("MP") packages use a copper plane on the PCB and the PCB itself as a heatsink. To optimize the heat sinking ability of the plane and PCB, solder the tab of the package to the plane.

Figure 3 shows for the TO-263 the measured values of  $\theta_{(J-A)}$  for different copper area sizes using a typical PCB with 1 ounce copper and no solder mask over the copper area used for heatsinking.

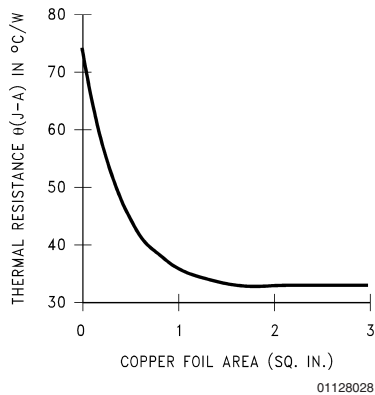

**FIGURE 3.  $\theta_{(J-A)}$  vs. Copper (1 ounce) Area for the TO-263 Package**

As shown in the figure, increasing the copper area beyond 1 square inch produces very little improvement. It should also be observed that the minimum value of  $\theta_{(J-A)}$  for the TO-263 package mounted to a PCB is 32°C/W.

As a design aid, Figure 4 shows the maximum allowable power dissipation compared to ambient temperature for the TO-263 device (assuming  $\theta_{(J-A)}$  is 35°C/W and the maximum junction temperature is 125°C).

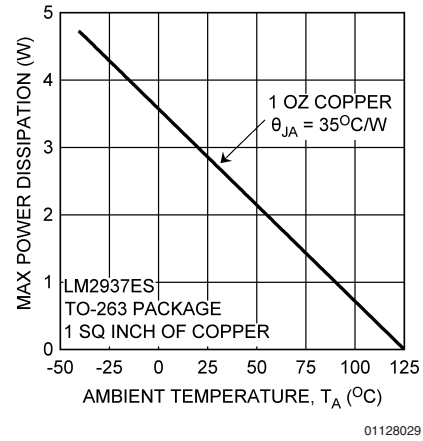

**FIGURE 4. Maximum Power Dissipation vs.  $T_{AMB}$  for the TO-263 Package**

Figure 5 and Figure 6 show the information for the SOT-223 package. Figure 6 assumes a  $\theta_{(J-A)}$  of 74°C/W for 1 ounce copper and 51°C/W for 2 ounce copper and a maximum junction temperature of +85°C.

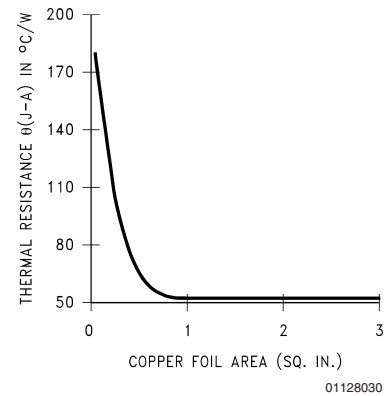

**FIGURE 5.  $\theta_{(J-A)}$  vs Copper (2 ounce) Area for the SOT-223 Package**

## Application Hints (Continued)

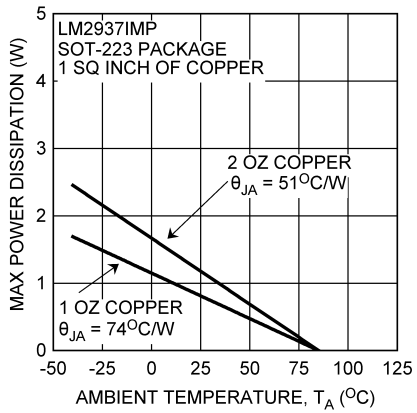

01128031

**FIGURE 6. Maximum Power Dissipation vs  $T_{AMB}$  for the SOT-223 Package**

### SOT-223 SOLDERING RECOMMENDATIONS

It is not recommended to use hand soldering or wave soldering to attach the small SOT-223 package to a printed circuit board. The excessive temperatures involved may cause package cracking.

Either vapor phase or infrared reflow techniques are preferred soldering attachment methods for the SOT-223 package.

## Physical Dimensions inches (millimeters) unless otherwise noted

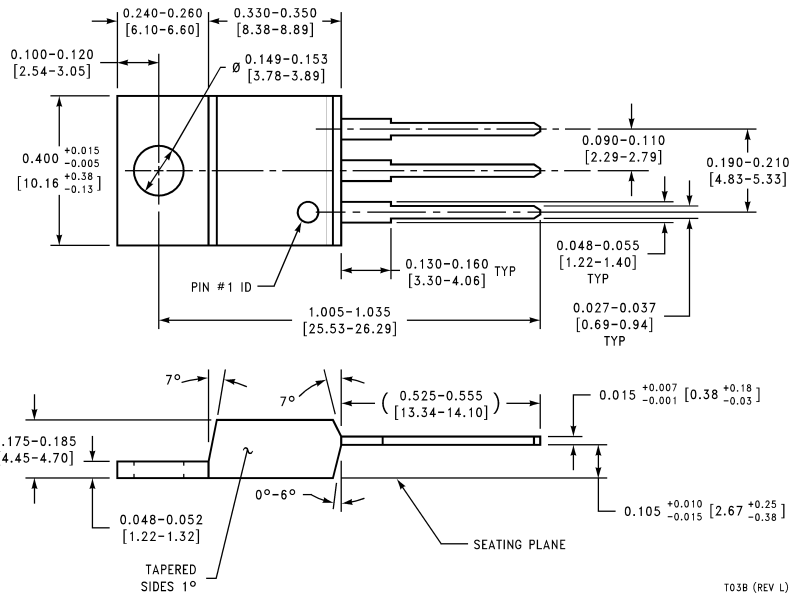

TO3B (REV L)

Plastic Package  
 Order Number LM2937ET-5.0,  
 LM2937ET-8.0, LM2937ET-10, LM2937ET-12,  
 or LM2937ET-15  
 NS Package Number T03B

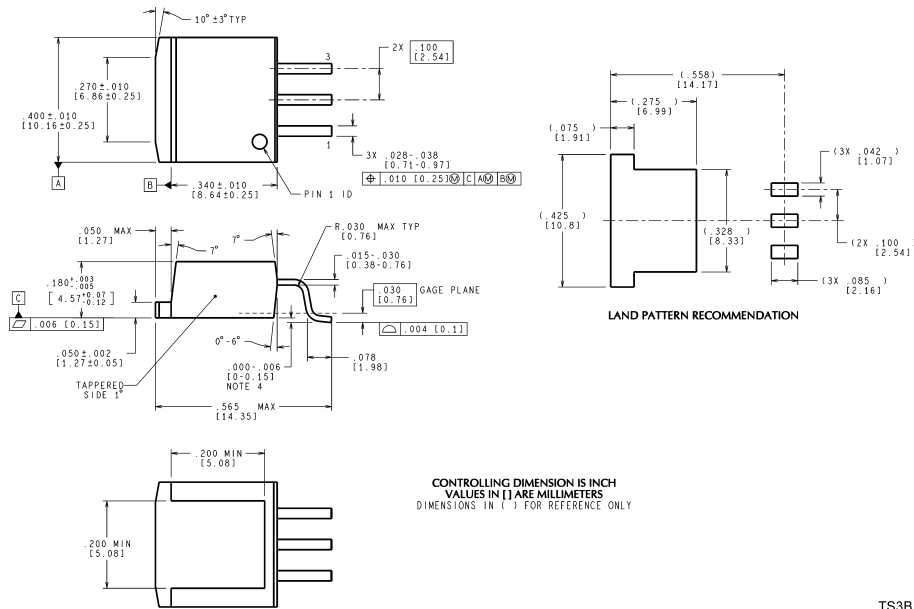

CONTROLLING DIMENSION IS INCH  
 VALUES IN [ ] ARE MILLIMETERS  
 DIMENSIONS IN ( ) FOR REFERENCE ONLY

TS3B (Rev F)

TO-263 3-Lead Plastic Surface Mount Package  
 Order Number LM2937ES-5.0, LM2937ES-8.0, LM2937ES-10, LM2937ES-12 or LM2937ES-15  
 NS Package Number TS3B

**Physical Dimensions** inches (millimeters) unless otherwise noted (Continued)

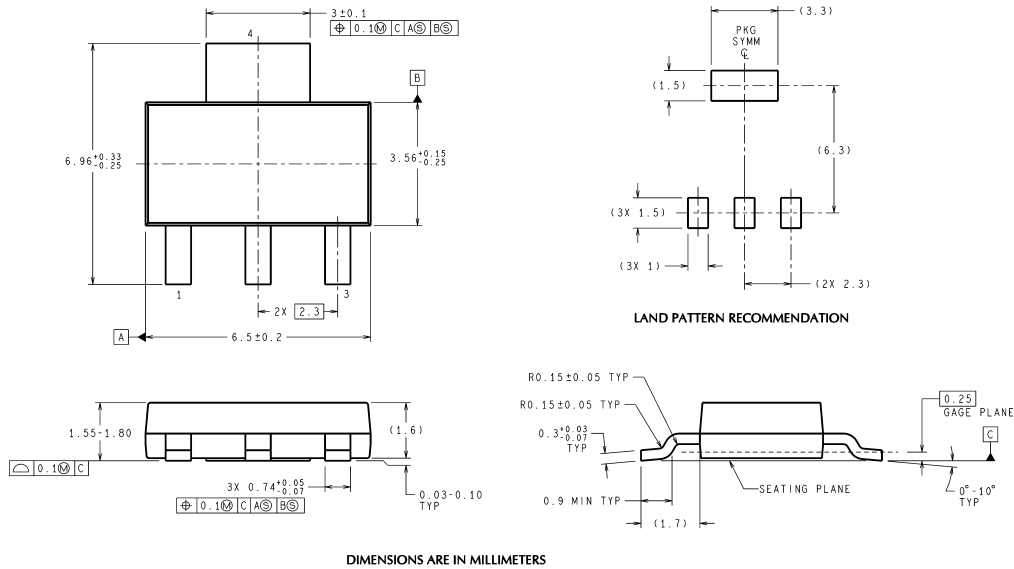

MP04A (Rev B)

**SOT-223 3-Lead Plastic Surface Mount Package**  
**Order Number LM2937IMP-5.0, LM2937IMP-8.0, LM2937IMP-10, LM2937IMP-12 or LM2937IMP-15**  
**NS Package Number MP04A**

National does not assume any responsibility for use of any circuitry described, no circuit patent licenses are implied and National reserves the right at any time without notice to change said circuitry and specifications.  
 For the most current product information visit us at [www.national.com](http://www.national.com).

**LIFE SUPPORT POLICY**

NATIONAL'S PRODUCTS ARE NOT AUTHORIZED FOR USE AS CRITICAL COMPONENTS IN LIFE SUPPORT DEVICES OR SYSTEMS WITHOUT THE EXPRESS WRITTEN APPROVAL OF THE PRESIDENT AND GENERAL COUNSEL OF NATIONAL SEMICONDUCTOR CORPORATION. As used herein:

1. Life support devices or systems are devices or systems which, (a) are intended for surgical implant into the body, or (b) support or sustain life, and whose failure to perform when properly used in accordance with instructions for use provided in the labeling, can be reasonably expected to result in a significant injury to the user.
2. A critical component is any component of a life support device or system whose failure to perform can be reasonably expected to cause the failure of the life support device or system, or to affect its safety or effectiveness.

**BANNED SUBSTANCE COMPLIANCE**

National Semiconductor manufactures products and uses packing materials that meet the provisions of the Customer Products Stewardship Specification (CSP-9-111C2) and the Banned Substances and Materials of Interest Specification (CSP-9-111S2) and contain no "Banned Substances" as defined in CSP-9-111S2.

Leadfree products are RoHS compliant.

**National Semiconductor**  
**Americas Customer Support Center**  
 Email: [new.feedback@nsc.com](mailto:new.feedback@nsc.com)  
 Tel: 1-800-272-9959

**National Semiconductor**  
**Europe Customer Support Center**  
 Fax: +49 (0) 180-530 85 86  
 Email: [europe.support@nsc.com](mailto:europe.support@nsc.com)  
 Deutsch Tel: +49 (0) 69 9508 6208  
 English Tel: +44 (0) 870 24 0 2171  
 Français Tel: +33 (0) 1 41 91 8790

**National Semiconductor**  
**Asia Pacific Customer Support Center**  
 Email: [ap.support@nsc.com](mailto:ap.support@nsc.com)

**National Semiconductor**  
**Japan Customer Support Center**  
 Fax: 81-3-5639-7507  
 Email: [jpn.feedback@nsc.com](mailto:jpn.feedback@nsc.com)  
 Tel: 81-3-5639-7560