

Surface Mounting SMT LED Indicator Components

Application Note 1060

Contents

- Surface Mount LED Indicators
- Standard EIA Tape and Reel Packaging
- Moisture Barrier Envelope Packaging
- SMT LED Device Lead Material
- PC Board Pad Design
- Automatic Placement Equipment Considerations
- Solder Paste
- Convective IR Reflow Soldering
- Type 2 PC Board Processing with LED Components
- Through-The-Wave Soldering

Surface Mount LED Indicators

Circuit board assemblies using surface mount technology (SMT) are now common and SMT LED indicators are being used on many of these SMT board assemblies. There are currently three basic types of Agilent Technologies SMT LED indicator components:

1. HLMx-xxxx domed and flat top subminiature lamps with formed leads:
 - Option 011 “gull wing” leads.
 - Option 021 “yoke” leads.
 - Option 031 “Z-bend” leads.

2. HSMx-xxxx Chip LED and flip chip LED indicator components.
 - HSMx-C670, -C650, -H670, -H690, -S670, -S690 top emitting components.
 - HSMx-H630, -H730 reverse mount components.
 - HSMx-R661, -R761, -S660, -C660 right angle emitting components.

3. HSMx-Axxx-xxxxx PLCC SMT LED

All these LED indicator component types may be mounted to a printed circuit (pc) board using automatic placement equipment and attached using a reflow solder process.

This application note provides information on how to successfully attach SMT LED indicators onto a pc board.

Standard EIA Tape and Reel Packaging

SMT LED lamps are packaged tape and reel in accordance with EIA Standard 481, *Taping of Surface Mount Components for Automatic Placement*. Reel and tape dimensions conform to EIA standards with individual SMT

LED lamps in the embossed carrier tape spaced on 4 mm (0.157 in.) centers. Figures 1a through 1e show the typical EIA standard dimensions for the reels and embossed tapes.

Moisture Barrier Envelope Packaging

The optical grade materials used in SMT LED components absorb moisture directly out of the air. Absorbed moisture in SMT LED components that have been reflow soldered to a pc board is typically of minor concern. However, moisture absorption in SMT LED components prior to reflow soldering is of serious concern. If moisture is absorbed by SMT LED components prior to soldering, the entrapped moisture turns to superheated steam during the solder process. The pressure of this superheated steam fractures the packages of the components causing catastrophic failure. Therefore, it is of vital importance to protect SMT LED components from absorbing moisture prior to soldering.

To protect the SMT LED components from moisture absorption during shipping and handling, reels for SMT LED components may be packaged in moisture barrier envelopes, as illustrated in Figure 2.



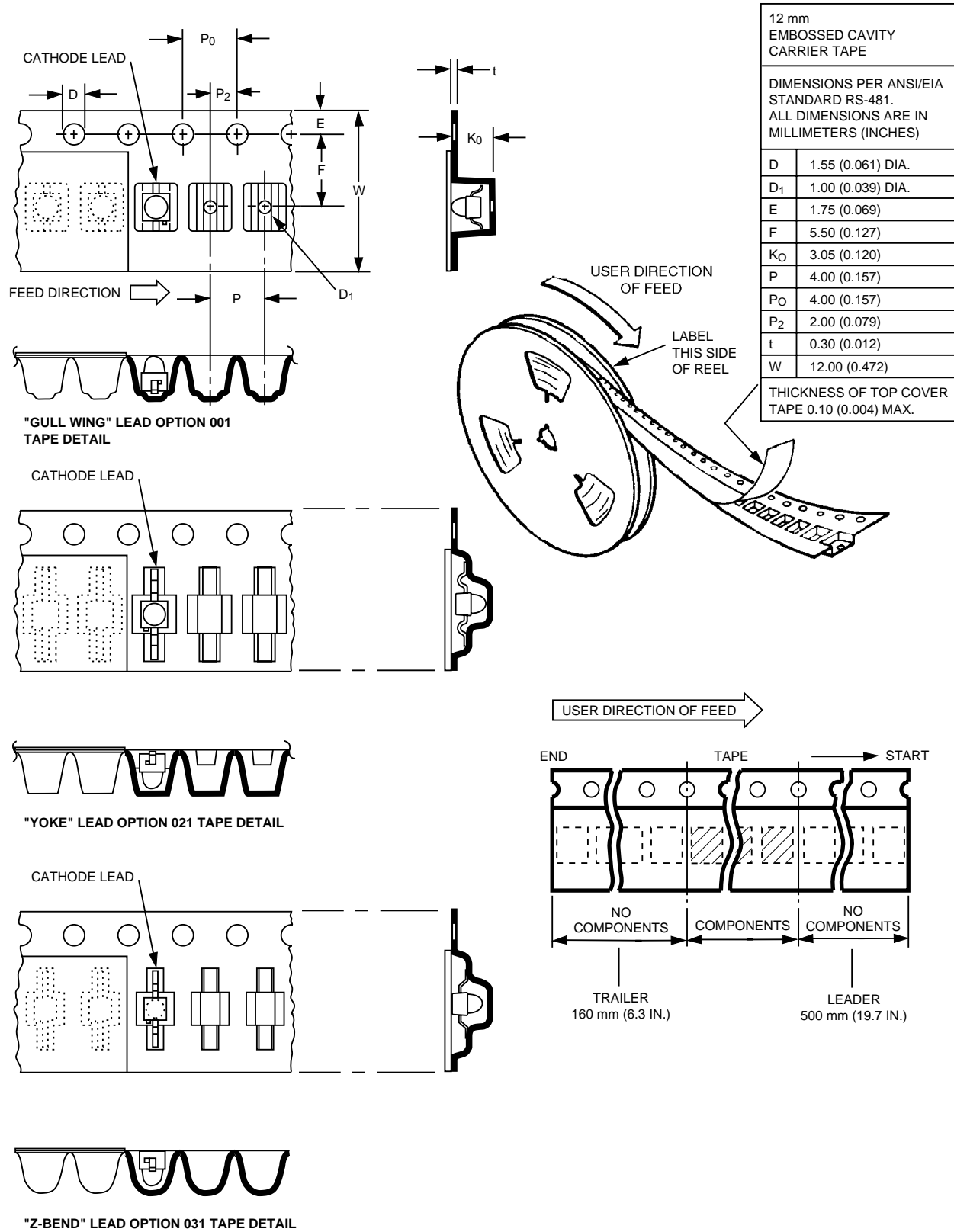
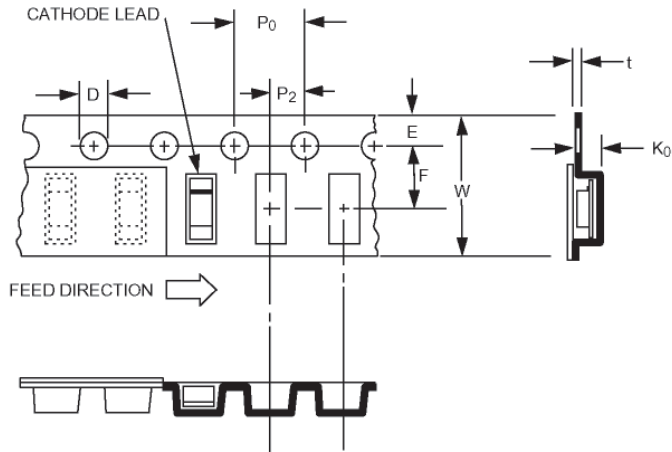
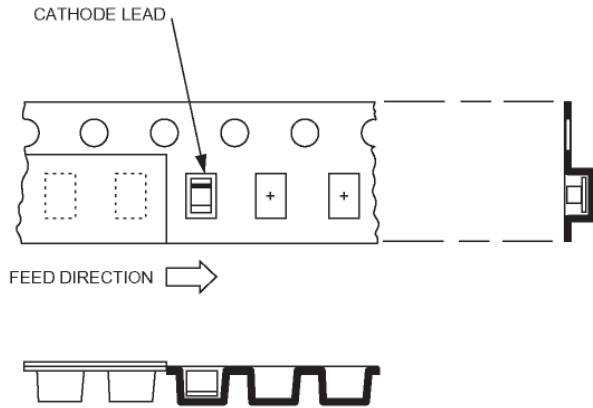

Figure 1a. 12 mm Embossed Cavity Carrier Tape Detail for HLMP-6XXX/-PXXX Series Subminiature SMT LED Lamps.



HSMX-C650 TAPE DETAIL

8 mm EMBOSSED CAVITY CARRIER TAPE	
DIMENSIONS PER ANSI/EIA STANDARD RS-481. ALL DIMENSIONS ARE IN MILLIMETERS (INCHES)	
D	1.55 (0.061) DIA.
E	1.75 (0.069)
F	3.51 (0.138)
K _O	1.30 (0.051)
P	4.00 (0.157)
P _O	4.00 (0.157)
P ₂	2.00 (0.079)
t	0.20 (0.008)
W	8.00 (0.315)
THICKNESS OF TOP COVER TAPE 0.10 (0.004) MAX.	



HSMX-C670, -H670, -S670 TAPE DETAIL

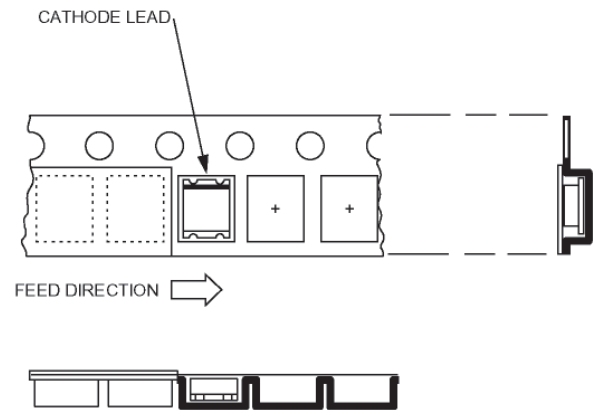
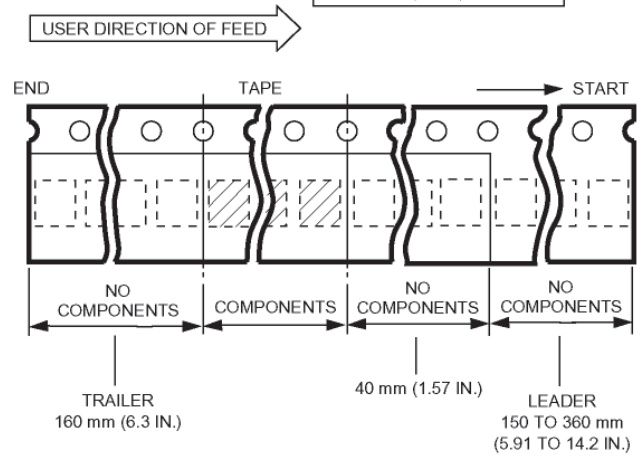

HSMF-C655 BI-COLOR TAPE DETAIL

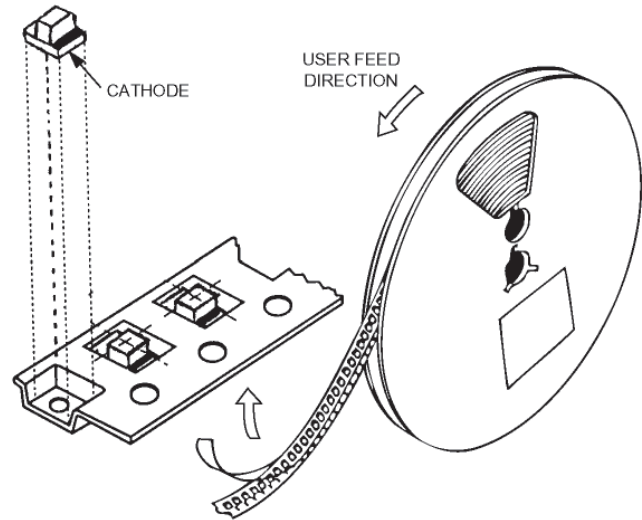
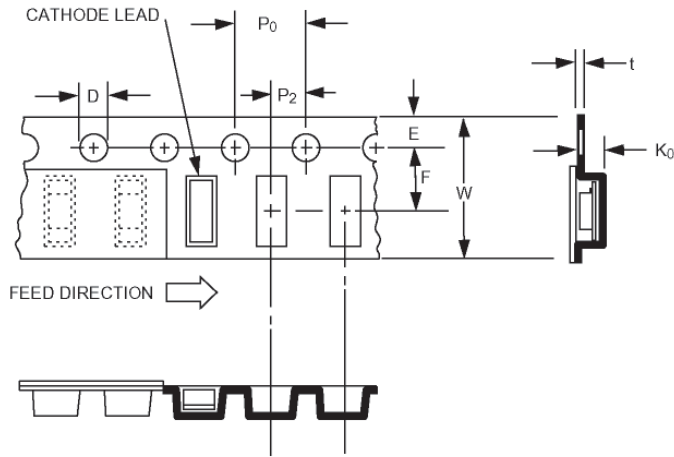
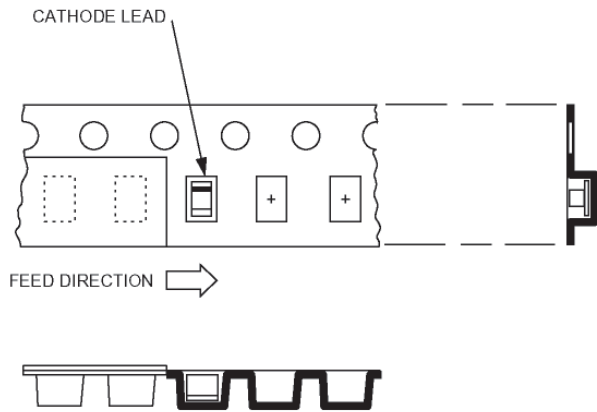

Figure 1b. 8 mm Embossed Cavity Carrier Tape Detail for HSMX-C650, -C670, -H670, -S670, -C655 Chip LED Lamps



HSMX-H630 TAPE DETAIL

8 mm EMBOSSED CAVITY CARRIER TAPE	
DIMENSIONS PER ANSI/EIA STANDARD RS-481. ALL DIMENSIONS ARE IN MILLIMETERS (INCHES)	
D	1.55 (0.061) DIA.
E	1.75 (0.069)
F	3.51 (0.138)
K _O	1.30 (0.051)
P	4.00 (0.157)
P _O	4.00 (0.157)
P ₂	2.00 (0.079)
t	0.20 (0.008)
W	8.00 (0.315)
THICKNESS OF TOP COVER TAPE 0.10 (0.004) MAX.	



HSMX-H690, -S690 TAPE DETAILS

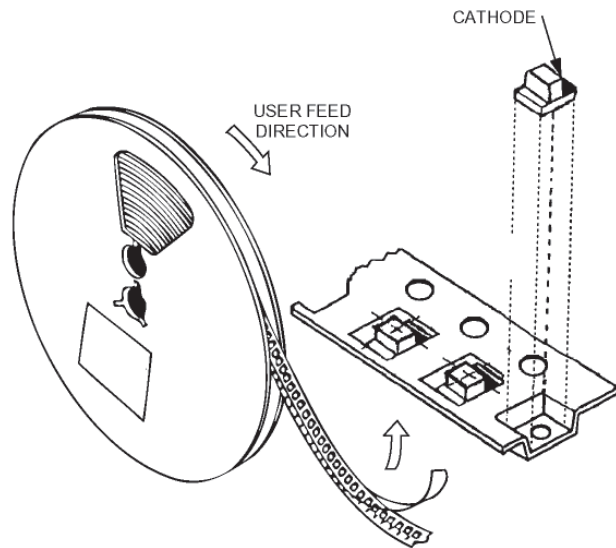
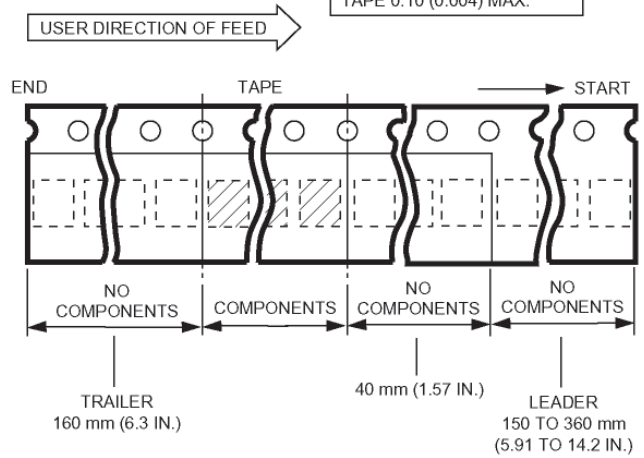

HSMX-H630

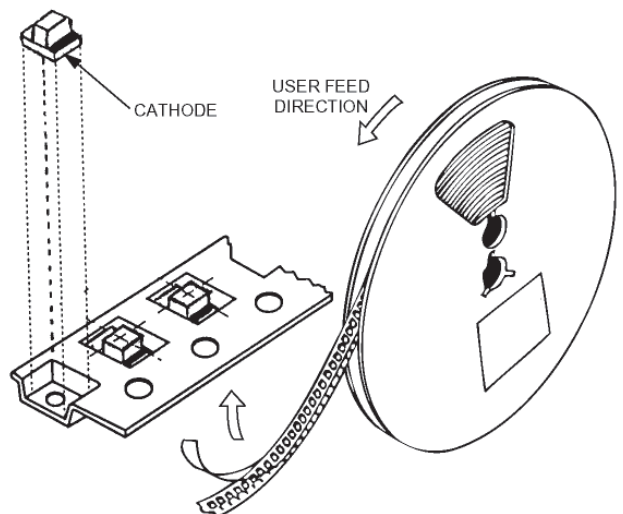

HSMX-S690

Figure 1c. 8 mm Embossed Cavity Carrier Tape Detail for HSMX-H630 and HSMX-H690, -S690 Chip LED Lamps.

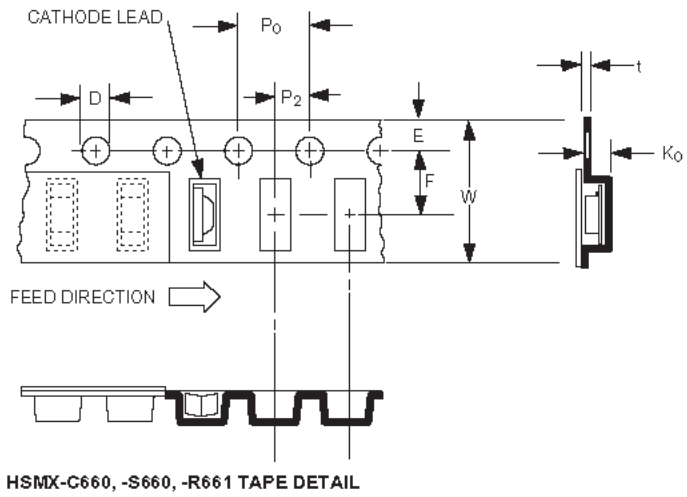

8 mm EMBOSSSED CAVITY CARRIER TAPE	
DIMENSIONS PER ANSI/EIA STANDARD RS-481. ALL DIMENSIONS ARE IN MILLIMETERS (INCHES)	
D	1.55 (0.061) DIA.
E	1.75 (0.069)
F	3.61 (0.138)
K ₀	
P	4.00 (0.157)
P ₀	4.00 (0.157)
P ₂	2.00 (0.079)
t	0.20 (0.008)
W	8.00 (0.315)
THICKNESS OF TOP COVER TAPE 0.10 (0.004)	

HSMX-C660, -S660, -R661 TAPE DETAIL

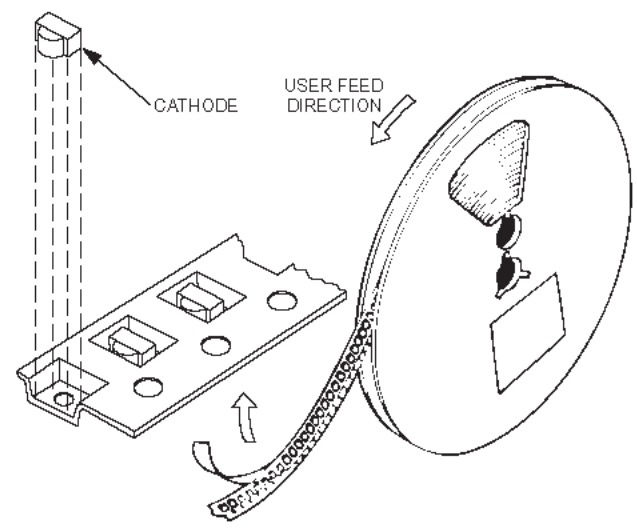
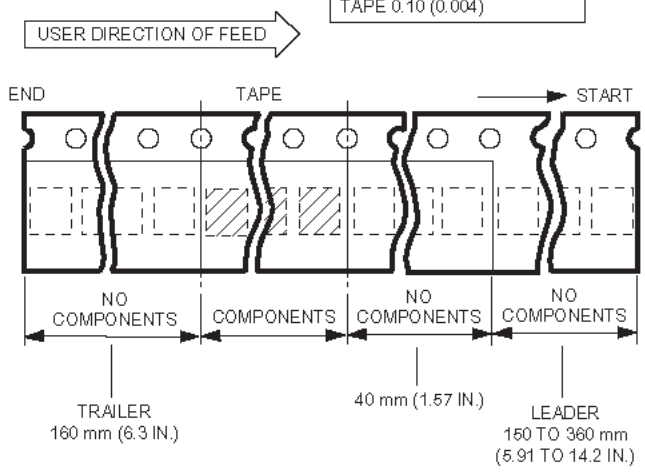
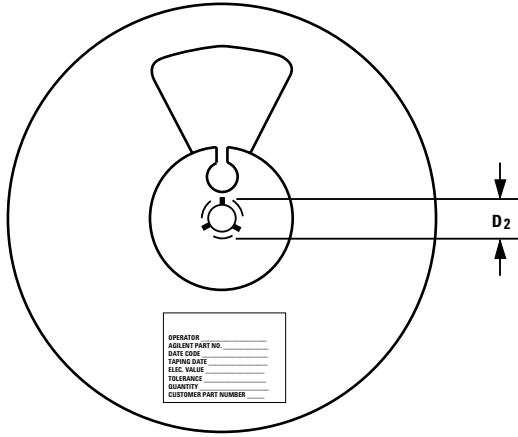
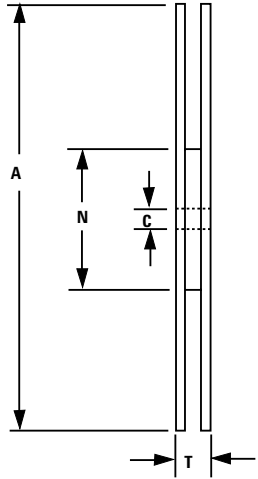

Figure 1d. 8 mm Embossed Cavity Carrier Tape Detail for HSMX-C660, -S660 and -R661 Right Angle Chip LED Lamps



7 INCH REEL DETAIL



DIMENSIONS PER ANSI/EIA STANDARD RS-481 ALL DIMENSIONS ARE IN MILLIMETERS (INCHES)		
	7 INCH REEL	13 INCH REEL
A	178.0 (7.0)	330.2 (13.0)
C	13.0 (0.512)	13.0 (0.512)
D ₂	20.2 (0.795)	20.2 (0.795)
N	60.0 (2.362)	100.0 (3.937)
T	8 mm	8 mm
	14.4 (0.567)	14.4 (0.567)
	12 mm	12 mm
	18.4 (0.724)	18.4 (0.724)

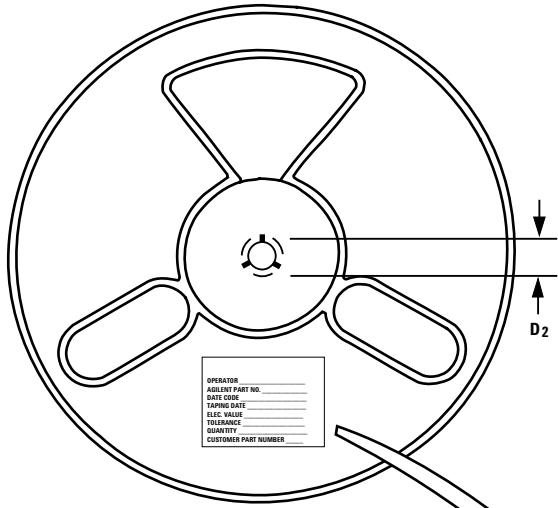

13 INCH REEL DETAIL

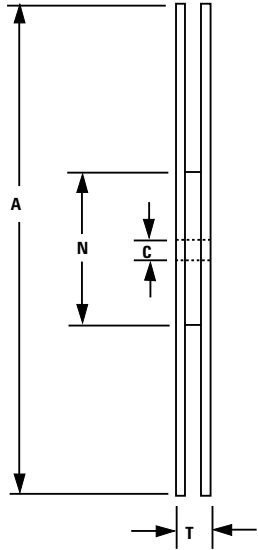

OPERATOR _____
 AGILENT PART NO. _____
 DATE CODE _____
 TAPING DATE _____
 ELEC. VALUE _____
 TOLERANCE _____
 QUANTITY _____
 CUSTOMER PART NUMBER _____

Figure 1e. 7 Inch and 13 Inch Reel Details.

Each envelope contains desiccant. To assure the moisture barrier seal, it is important to protect these envelopes from being punctured by sharp objects such as staples. Once opened, SMT LED components should be handled in accordance with the recommendations for their appropriate moisture sensitivity classification. The Joint Industry Standard J-STD-020, Moisture/Reflow Sensitivity Classification for Plastic Integrated Circuit Surface Mount *Devices*, issued by the EIA/JEDEC JC-14.1 Committee establishes the necessary handling recommendations for each moisture sensitivity classification. For information on the appropriate moisture sensitivity classification of Agilent Technologies SMT LED components, contact your Agilent Technologies representative.

SMT LED Device Lead Material

The lead base metal and surface finish for SMT LED components are listed in Table 1. The subminiature lamp components utilize a lead frame in their construction. The various chip LED and flip chip LED components utilize a pc board as the device substrate.

PC Board Pad Design

The design of the pc board metallic attachment pads is important to assure both position on and attachment to an SMT board assembly. Solder coated one ounce copper pads are best for reflow soldering.

PC Board Pad Design Considerations and Device-to-Device Pad Alignment

Placing an SMT LED component on the pc board so its axis is oriented perpendicular to the long dimension side of the board, as shown in Figure 3, will tend to reduce stress on the device during temperature cycling. Placing the axis of an SMT LED component parallel to the long dimension side of the pc board will increase the probability of defects. The proper design of pc board attachment pads, as illustrated in Figure 4, will increase the probability of proper reflow solder connections. Pad size should not exceed recommended pad dimensions by more than 0.25 mm (0.010 in.). Accurate placement of the SMT components onto the pc board attachment pads enhances the probability of proper alignment after solder freeze. When the pc board pads are of the correct size in relation to the device leads, the SMT LED components will self center align with respect to the pads, assisted by the capillary attraction/wetting forces of the hot liquid solder.

PC board traces should connect to the center of each attachment pad. Traces that connect to the outer edges of pads impart a torque to the SMT LED component which contributes to skewing and off centering problems. Adjacent attachment pads for SMT LED components electrically connected in series should be connected with a trace that is a maximum of 0.20 inches wide. Solder resist masking should be well defined around the perimeter of the attachment pads, without voids or smears over the pads that will inhibit the formation of good solder connections.

Subminiature Lamp Components

Figure 5 shows the mounting orientation to a pc board for the Option 011 “gull wing,” Option 021 “yoke,” and Option 031 “Z-bend” lead subminiature lamp components. All three option devices are for mounting on the component side (non-solder side) of a pc board, with both the “yoke” and “Zbend” components mounted upside down through a hole in the pc board. Installed on a 1.52 mm (0.060 in.) thick pc board, the lamp dome of a “yoke” lead component will protrude out the solder side about 0.38 mm (0.015 in.), and a “Z- bend” component will be flush to recessed 0.38 mm (0.015 in.).

Table 1. Lead Base Metal and Lead Finish for SMT LED Indicator Components.

SMT LED Indicator Component	Lead Base Metal	Lead Finish
HLMP-6XXX/-PXXX	Copper/Iron Alloy, OLIN 194	Solder Plate, 85% Sn/15% Pb
Chip LED and Flip Chip LED	Copper on pc Board Substrate	Gold over Nickel Alloy

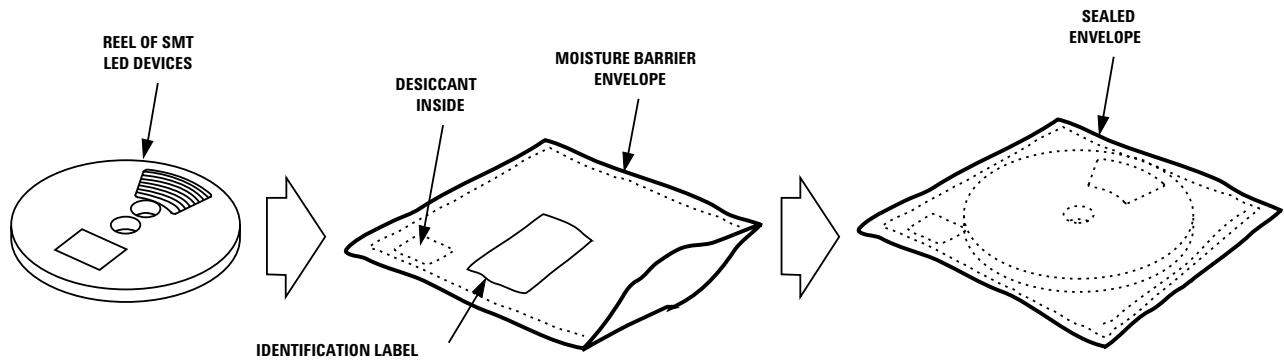

Figure 2. Moisture Barrier Envelope Packaging for SMT LED Indicator Components.

Figure 6 shows the pc board pad layout for the Option 011 “gull wing” lead components. Figure 7 shows the pc board pad layouts for Option 021 “yoke” lead and Option 031 “Z-bend” lead components.

A Type 2 pc board assembly contains both surface mount and through hole components. For Option 021 “yoke” lead and Option 031 “Z-bend” lead components mounted on a Type 2 board that will be wave soldered, the clearance through hole in the pc board should be temporarily closed off on the solder side with a removable solder resist cover, as shown in Figure 8. This removable solder resist cover prevents flux and solder from flowing up through the clearance hole during wave solder and being deposited on the leads the LED device. This unwanted excess solder deposit restrains the component leads from absorbing thermal stresses during temperature cycling and will inevitably lead to catastrophic failure of the SMT LED component.

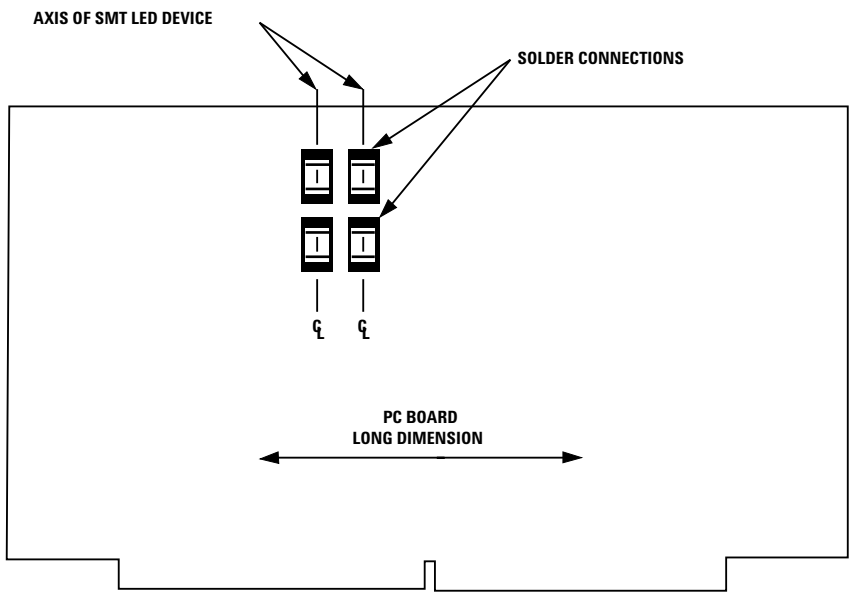
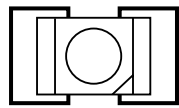
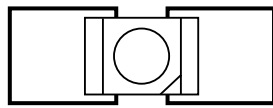

Figure 3. Recommended Orientation of SMT LED Components on PC Boards for Minimum Stress.



CORRECT
PAD SIZE



PADS
TOO LONG

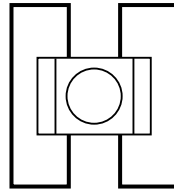

PADS TOO WIDE

PC BOARD ATTACHMENT PAD SHAPES

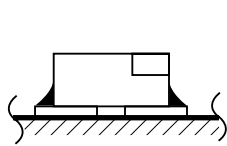

SMT LED IS
SELF CENTERED

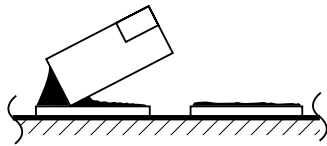

TOMBSTONING
SMT LED

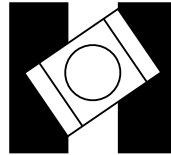

SKEWED SMT LED

REFLOW SOLDERED SMT LED

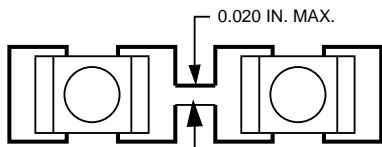

GOOD DESIGN

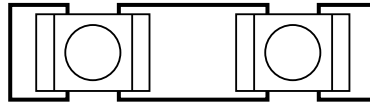

INFERIOR DESIGN

PADS IN A SERIES CONNECTION

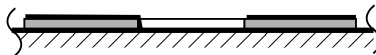
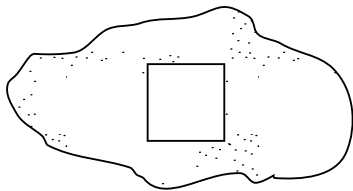

GOOD SOLDER
MASKING

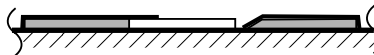
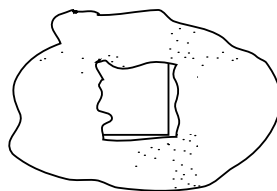

UNACCEPTABLE
SOLDER MASKING

SOLDER MASKING

SOLDER MIGRATION

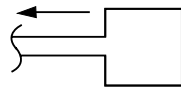

GOOD TRACE
CONNECTION

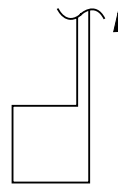

SOLDER
MIGRATION
ADDS A TORQUE

POOR TRACE
CONNECTION

CIRCUIT TRACE-TO-PAD CONNECTIONS

Figure 4. PC Attachment Pad Design Considerations for SMT LED Components. Pad Dimensions should not exceed 0.25 mm (0.010) in.) Recommended Size.

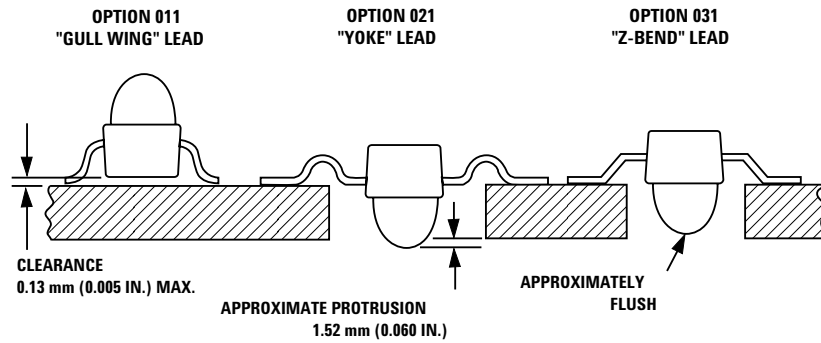

Figure 5. Orientation of HLMP-6XXX/-PXXX SMT LED Component Options on a PC Board.

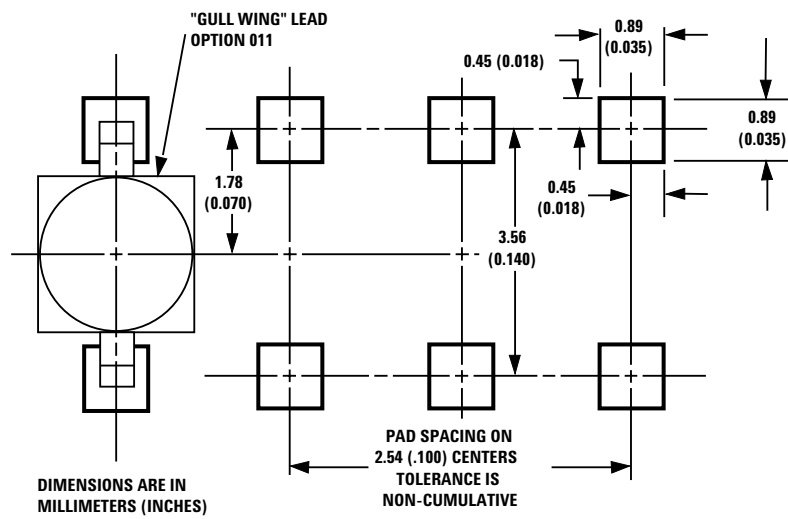

Figure 6. PC Board Attachment Pad Layout for HLMP-6XXX/-PXXX "Gull Wing" Lead Option 011 Single Indicator and Option 013 Linear Array Subminiature SMT LED Components. PC Board Solder Dipped, Hot Air Leveled.

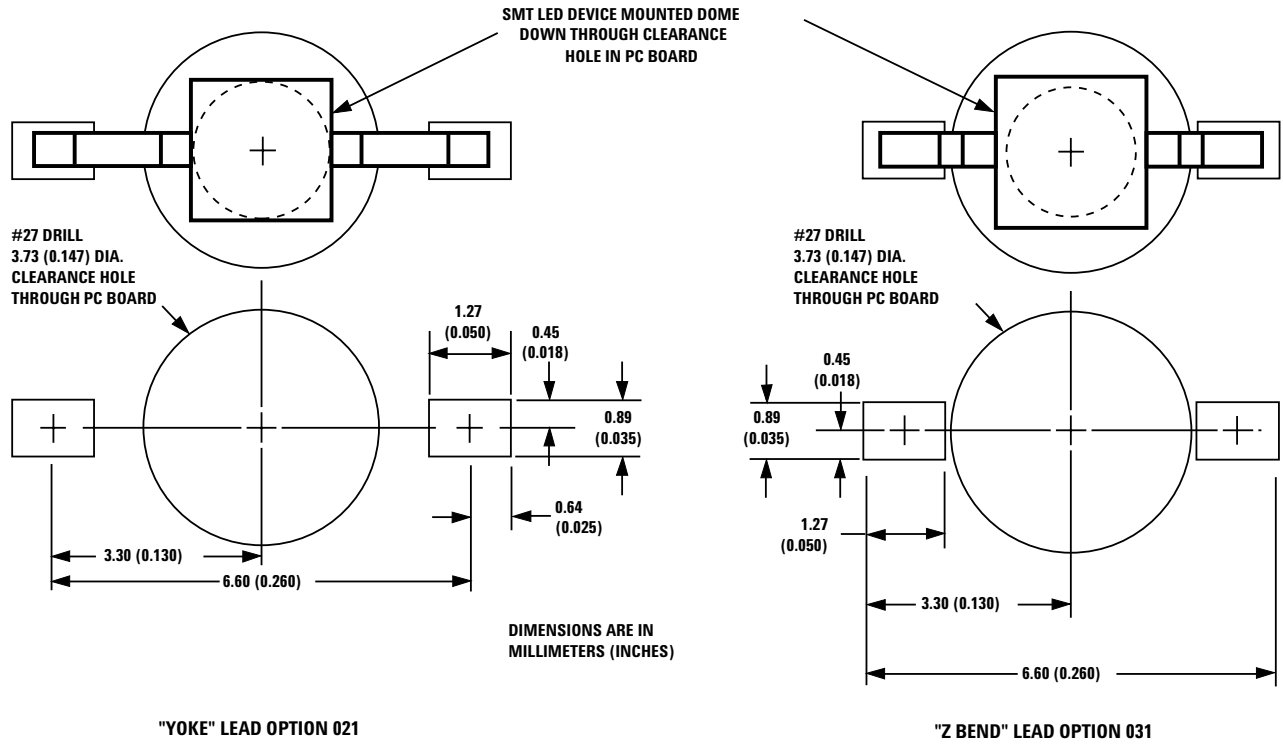

Figure 7. PC Board Attachment Pad Layout for HLMP-6XXX/-PXXX "Yoke" Lead Option 021 and "Z-Bend" Lead Subminiature SMT LED Components, Mounted Dome Down Through Clearance Hole in PC Board. PC Board Solder Dipped, Hot Air Levelled.

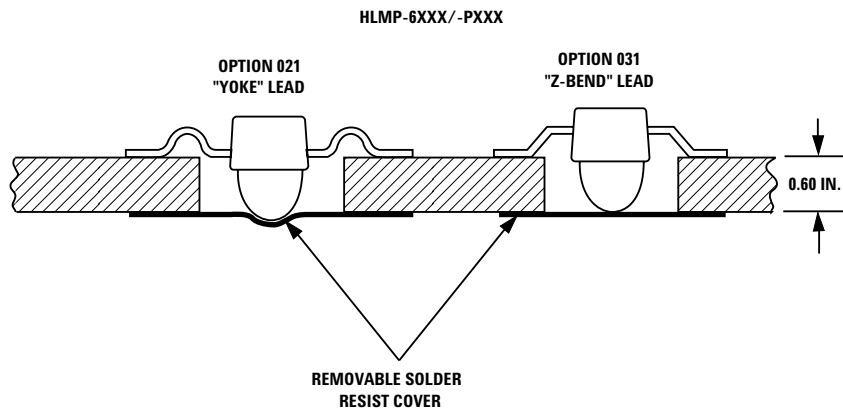

Figure 8. Removable Solder Resist Cover to Close Off Through Hole in a Type 2 PC Board to Protect LED Component During a Wave Solder Operation.

Chip LED Lamp Components

Figure 9 shows the pc board attachment pad layouts for the Chip LED and flip Chip LED components. These attachment pad layouts may be used for both reflow solder and conductive attachment. The width of the attachment pads is about 0.1 mm (0.004 in.) narrow with respect to the width of the respective top emitting and reverse mount components to assure alignment of the device with respect to the pads. Note, the reflow solder pads are on a pc board that has been solder dipped and hot air leveled; the epoxy attachment pads are clean bare copper.

Automatic Placement Equipment Considerations

The subminiature Option 011 “gull wing” lead components are mounted upright in the embossed cavities of the carrier tape. A hole is located in the bottom of each embossed cavity to allow an automatic pick and place machine to utilize a push pin to assist in device removal from the carrier tape.

The subminiature Option 021 “yoke” lead and Option 031 “Zbend” lead components are mounted top side down in the carrier tape. Since the round domes of the device packages are pointing down, the bottoms of the embossed cavities do not have push-pin holes. Also, the carrier tape for the chip LED components does not have push-pin holes in the bottom of the embossed cavities. Thus, the push-pin action of the automatic pick and place machine must be disabled when picking these devices from the carrier tape.

The top side surfaces of SMT LED components, as they sit in the embossed cavities of the carrier tape, present to a pick-up tool either a surface that is not perfectly flat or a round dome. As a result, the typical stainless steel vacuum pick-up tool may not form a vacuum seal with the device package and thus may not be able to pick it out of the embossed cavity. Figure 10 shows a flat soft tip pick-up tool for picking up chip LED components and subminiature lamp Option 021 “yoke” lead and Option 031 “Z-bend” lead components that are mounted upside down in the embossed cavities. The soft tip pick-up tool is usually made of nylon or other soft plastic. For picking up subminiature lamp Option 011 “gull wing” domed components, the end of the soft tip should be contoured concave to fit snugly over the dome of that particular SMT LED device to form a vacuum seal.

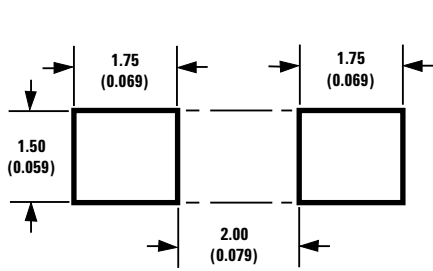

HSMX-C650

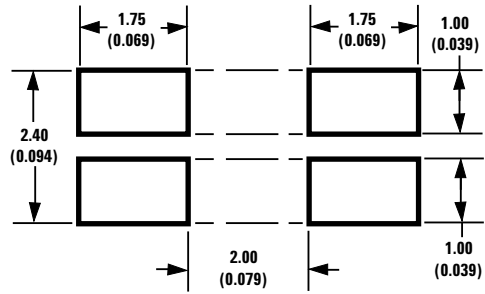

HSMF-C655

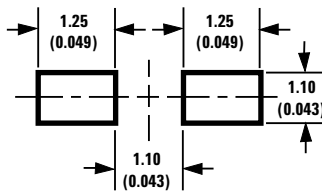

HSMX-C670, -H670 SERIES

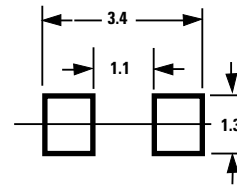

HSMX-S670 SERIES

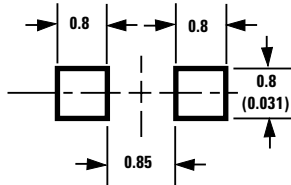

HSMX-H690/H790 SERIES

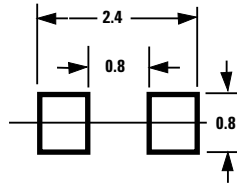

HSMX-S690 SERIES

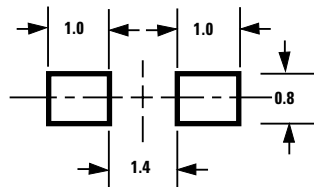
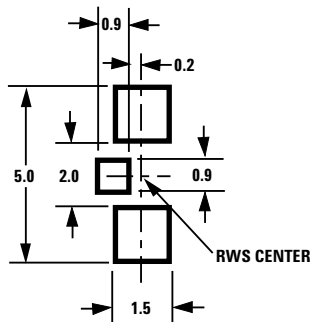
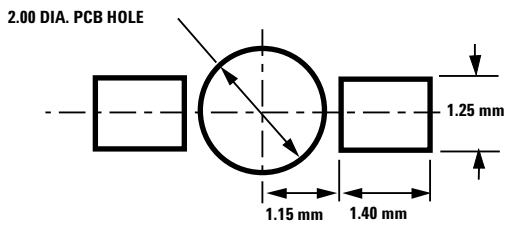

HSMX-R661/R761 SERIES

Figure 9. PC Board Attachment Pad Layouts for Chip LED and Flip Chip LED Components.

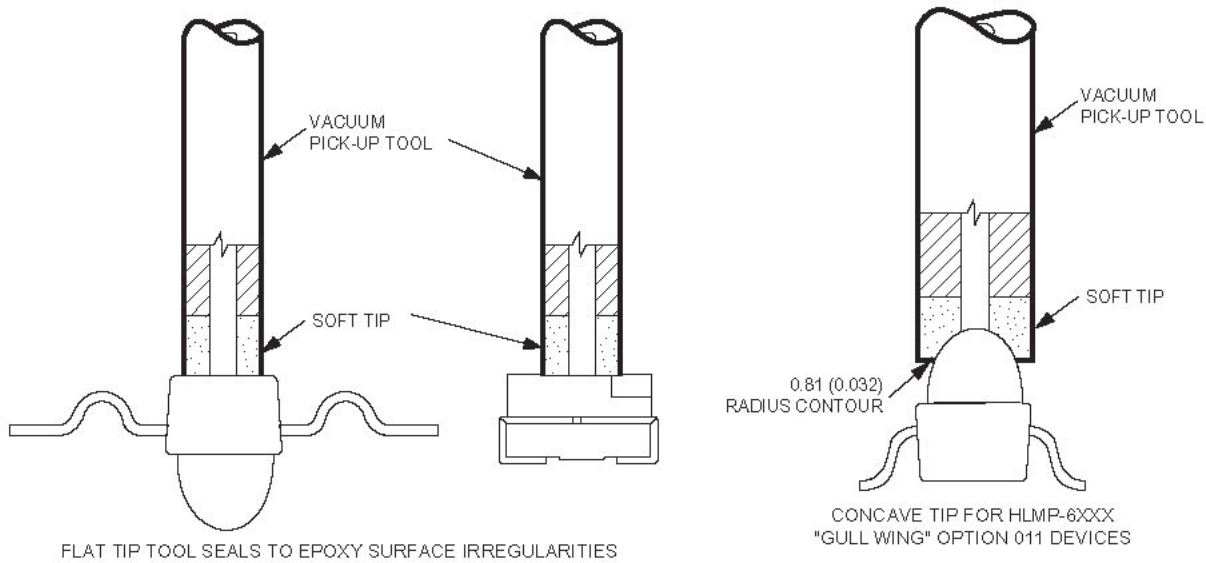

Figure 10. Soft Tip Vacuum Pick-up Tool for Extracting SMT LED Components from Embossed Carrier Tape.

Solder Paste

For best results, an SN63 eutectic solder paste, liquidus at +183 °C (+361 °F), should be used. SN62 solder paste containing 2% silver, liquidus at +189 °C (+372 °F), may be used with the chip LED devices, with the advantage of obtaining stronger solder connections, but higher cost. The solder paste should contain 85 to 95% by weight (38 to 67% by volume) solder ball powder, with the size of the spherical solder balls screened -200/+325 mesh. The solder paste should be stable over time after deposition on the pc board. After deposition, a well formulated paste will not degrade or change reflow characteristics due to moisture absorption and oxidation over time period of 12 hours at room temperature. Refrigerated storage of unused solder paste extends shelf life, typically beyond three months at 0 °C (+32 °F). The solder paste may be deposited onto pc board pads by either screen printing, using a stencil, or by syringe dispensing.

The viscosity range of the solder paste should be specified for the specific deposition process to be used: between 500,000 and 600,000 centipoise for screen printing, between 700,000 and 800,000 centipoise for stencil printing, and between 350,000 and 450,000 centipoise for dispensing. An 80 mesh screen will provide a solder deposition thickness of 0.20 mm (0.008 in.). The solder paste should cover the pad with a smooth, even contour, without voids. Voids in the deposited solder paste may be due to contamination or oxidation on the pc board metal pads, improper solder paste viscosity, clogged openings in the screen mesh, or a "dirty" syringe dispensing tool. Since solder paste will wick outward by 0.004 to 0.005 inches, the deposited paste should cover the attachment pad just short by this amount.

Convective IR Reflow Soldering

All SMT LED components may be reflow soldered using a convective IR process. A convective IR process uses middle to long infrared wavelengths (approximately 4000 to 6200 nanometers). Approximately 65% of the energy is used to heat the air in the reflow chamber (convective heating) and 35% of the energy directly heats the pc board and components (radiative heating). Some systems are forced hot air systems with a dual chamber design, where one chamber has IR heaters to heat the air which is then blown over the pc board assemblies located in a second chamber. In these systems, heating is 100% convective. The pc board and components are uniformly heated to achieve reliable solder connections. The thermal stresses experienced by SMT LED components are minimized in a convective thermal environment.

Figure 11 is a straight-line representation of a nominal temperature profile for a convective IR reflow solder process. The temperature profile is divided into four process zones with four $\Delta T/\Delta \text{time}$ temperature change rates. The $\Delta T/\Delta \text{time}$ temperature change rates are detailed in Table 2. The temperatures are measured at the component to pc board connections.

Process Zone P1

In process zone P1, the pc board and SMT LED components are heated to a temperature of +125 °C to activate the flux in the solder paste. The temperature ramp up rate, R1, is limited to +3 °C per second to allow for even heating of both the pc board and the SMT LED components.

Process Zone P2

Process zone P2 should be of sufficient time duration to dry the solder paste. The temperature is raised to a level just below the liquidus point of the solder, usually +170 °C (+338 °F) for leaded IR reflow solder process and [+217 °C (+422.6 °F)] for lead free reflow solder process.

Process Zone P3

Process zone P3 is the solder reflow zone. In zone P3, the temperature is quickly raised above the liquidus point of solder to +230 °C (+446 °F) [+260 °C (+500 °F)] for optimum results. The dwell time above the liquidus point of solder should be between 15 and 90 seconds. It usually takes about 15 [60] seconds to assure proper coalescing of the solder balls

into liquid solder and the formation of good solder connections. Beyond a dwell time of 90 [150] seconds, the intermetallic growth within the solder connections becomes excessive, resulting in the formation of weak and unreliable connections. The temperature is then rapidly reduced to a point below the solidus temperature of the solder, usually +170 °C (+338 °F) for leaded IR reflow solder process and [+217 °C (+422.6 °F)] for lead free IR solder process, to allow the solder within the connections to freeze solid.

Note:

Values shown in [] are for lead free IR reflow solder process.

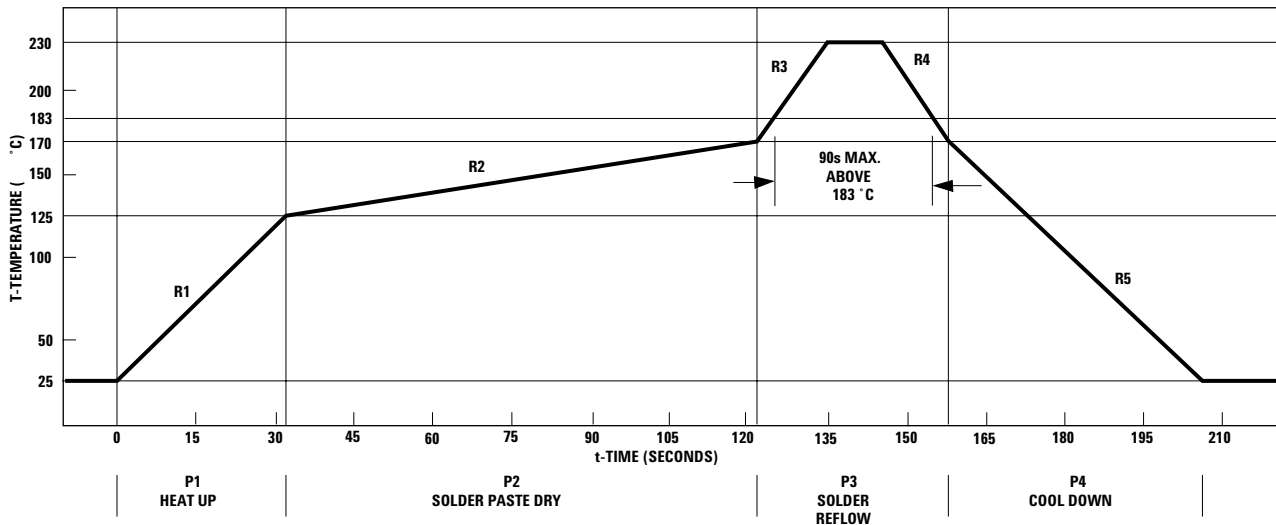

Figure 11. The Temperature Profile for a Nominal Convective IR Reflow Solder Process. See Table 2 for Temperature (RX) Values.

Table 2. Convective IR Reflow Process Zones. See Figure 11.

Process Zone	Symbol	ΔT	$\Delta T/\Delta \text{time}$
Heat Up	P1, R1	+25 °C to +125 °C	+3 °C/s MAX
Solder Paste Dry	P2, R2	+125 °C to +170 °C	+0.5 °C/s MAX
Solder Reflow	P3, R3	+170 °C to +230 °C (+235 °C MAX)	+4.5 °C/s TYP
	R4	+230 °C to +170 °C	-4.5 °C/s TYP
Cool Down	P4, R5	+170 °C to +25 °C	-3 °C/s MAX

Process Zone P4

Process zone P4 is the cool down after solder freeze. The cool down rate, R5, from the liquidus point the solder to +25 °C (+77 °F) should not exceed -3 °C (+26.6 °F) [-6 °C (+21.2 °F)] per second maximum. This limitation is necessary to allow the pc board and SMT LED devices to change dimensions evenly, putting minimal stresses on the SMT LED device packages.

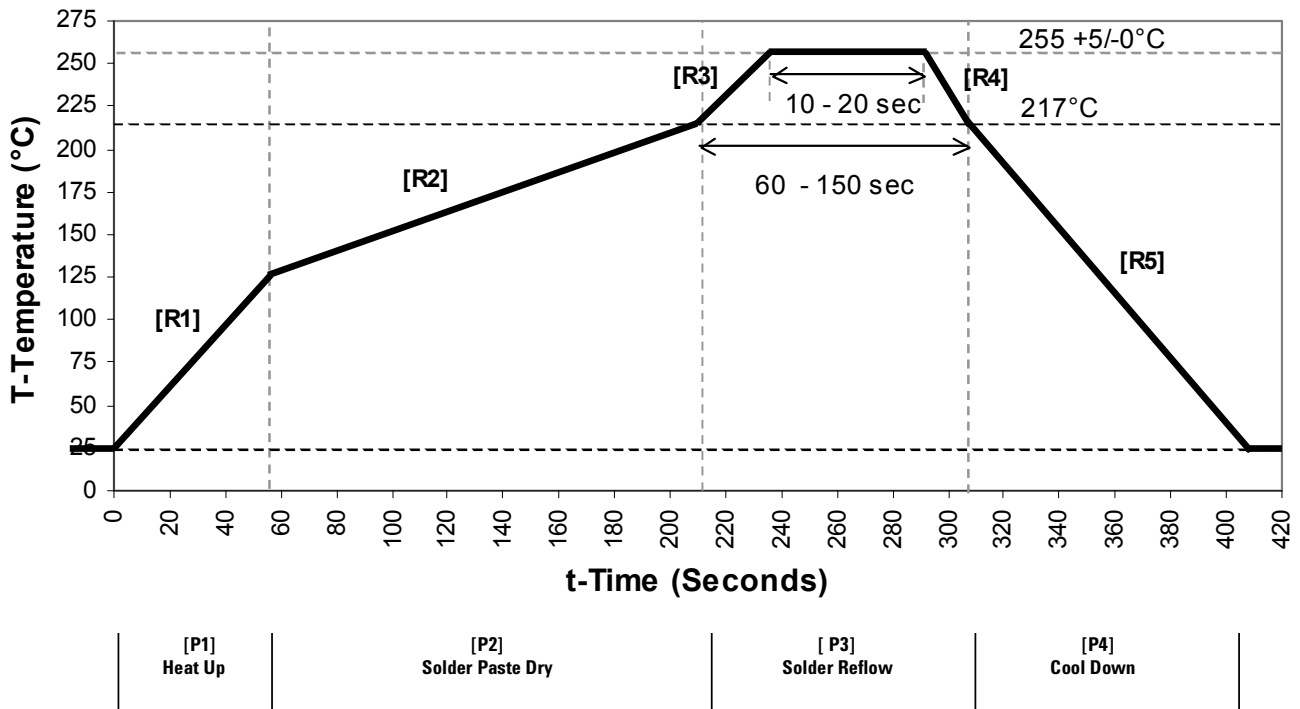

Figure 12: Recommended Sample Lead-Free Temperature Profile IR Reflow Solder Process. See Table 3 for “ Temperature [RX] Values.

Table 3. Recommended Lead-Free IR Reflow Process Zones. See Figure 12.

Processes	Symbol	ΔT	$\Delta T/\Delta time$
Heat up	[P1], [R1]	+25 °C to +125 °C	N/A
Solder Paste Dry	[P2], [R2]	+125 °C to +217 °C	N/A
Solder Reflow	[P3], [R3], [R4]	+217 °C to +255 °C +255 °C to +217°C	+3 °C/s MAX -3 °C/s MAX
Cool Down	[P4], [R5]	+217 °C to +25 °C	-6 °C/sec MAX

Note:

Values shown in [] are for lead free IR reflow solder process.

Type 2 PC Board Processing With LED Components

A Type 2 pc board assembly has both SMT LED and through hole LED components installed. The processing sequence of Type 2 pc boards is important to assure final assembly yield. The following suggested processing sequences assure high post-solder yields for both the SMT LED and through hole LED components. The processes described are assumed to be high volume, automated processes with auto-insertion of through hole LED components. The SMT LED components are placed onto the top surface of the pc board with automated placement equipment. Attachment epoxy may be used to hold the SMT LED components to the pc board until the board is reflow soldered. The automated solder paste screen printer, SMT placement equipment, auto-insertion machine, reflow and wave solder machines, and post solder cleaning unit are all part of a continuous in-line process with automated board handling equipment.

Preferred Process

Reflow solder SMT LED components prior to auto-insertion of through hole LED components. The reflow and wave solder operations are separated by the auto-insertion operation.

1. Screen print the solder paste and deposit the attachment epoxy for the SMT LED components.
2. Auto-place the SMT LED components.
3. Cure the attachment epoxy and dry the solder paste.
4. Reflow solder the SMT LED components.
5. Auto-insert the through hole LED components.

6. Wave solder the through hole LED components.
7. Clean the pc board assembly.

This process sequence has the following advantages:

1. The SMT LED components are attached to the pc board prior to auto-inserting the through hole LED components.
2. Since the SMT LED components are reflow soldered, they are not displaced from the pc board during auto-insertion of the through hole LED components.
3. Wave soldering the pc board after solder reflow does not remelt the SMT solder connections.
4. The through hole LED components are not exposed to the high temperatures of the reflow solder operation.

Alternate Process

Auto-insert the through hole LED components prior to placing the SMT LED components, then reflow and wave solder in direct sequence.

1. Screen print the solder paste and deposit the attachment epoxy for the SMT LED components.
2. Auto-insert the through hole LED components.
3. Auto-place the SMT LED components.
4. Cure the attachment epoxy and dry the solder paste.
5. Reflow solder the SMT LED components.
6. Wave solder the through hole LED components.
7. Clean the pc board assembly.

This process sequence has the following advantages:

1. The through hole LED components are auto-inserted prior to attaching the SMT LED components.

2. The SMT LED components are not subject to displacement off the pc board during auto-insertion of the through hole LED components.
3. Since the through hole LED components are loose on the pc board (not soldered) they are better able to withstand exposure to the high temperatures of the reflow solder operation.
4. Wave soldering the pc board after solder reflow does not remelt the SMT solder connections.

Precautions When Handling HSMx-C540 and HSMx-C220

1. Once the moisture barrier bag unsealed, the best method is to finish the reel. Otherwise, it is advisable to immediately store the unfinished parts in the moisture barrier bag and seal.
2. For double-sided PCB with SMT components on both sides, it is advisable to subject both sides to one time reflow only, meaning that the components will be soldered during the second reflow.
3. Avoid rinsing before solder reflow. If this is unavoidable, then bake dry the components/ board before solder reflow.

Through-The-Wave (TTW) Soldering

Not all SMT LED components can be mounted on the solder side of a pc board. See Table 3 for a list of Agilent Technologies SMT LED components which can be processed by TTW soldering. Attaching SMT LED components to the solder side of a pc board using TTW processing can be accomplished by carefully controlling the wave solder process. It is absolutely imperative that the SMT LED components be free of absorbed moisture before being exposed to TTW solder processing, see section titled *Moisture Barrier Envelope Packaging* for appropriate handling measures. If the SMT LED components contain absorbed moisture, there is a high probability that the absorbed moisture will be turned into superheated steam by the large thermal mass of a solder wave, causing device popcorning to occur.

A nitrogen atmosphere solder wave machine is recommended to achieve the highest possible solder connection yields. The use of a high quality no-clean flux and SN63 eutectic solder are encouraged. Spraying the no-clean flux onto the solder side of the pc board is recommended. Coverage is superior to foam fluxing, and the amount of flux deposited onto the pc board can be controlled to assure proper fluxing of all SMT component connections.

It is critical that the temperature difference between the preheat temperature and the solder wave temperature must not exceed the maximum of +100 °C (+180 °F), as measured at a solder connection on the solder side of the pc board. SMT LED components, like many SMT ceramic chip capacitors, are not able to withstand an instantaneous thermal shock

Table 4. TTW Processing Compatibility of SMT LED Components

Product Series	Approved for TTW (Yes/No)
HLMx-xxxx Subminiature Lamps	No
HSMx-Cxxx Chip LEDs	No
HSMx-Sxxx Chip LEDs	No
HSMx-H670 Flip Chip LEDs	Yes
HSMx-H690 Flip Chip LEDs	Yes
HSMx-R661 Right Angle Chip LEDs and Flip Chip LEDs	Yes
HSMx-Axxx-xxxxx PLCC SMT LED	Yes

Absolute Maximum Ratings for TTW Processing of SMT LED Components

Temperature Difference Between Preheat and Solder Wave:	+100 °C (+180 °F)
Preheat:	+160 °C
Solder Wave:	+250 °C
Dwell Time:	10 seconds

temperature difference greater than +100 °C. The following temperature, dwell time Absolute Maximum Ratings for TTW processing must be observed to assure high yields.

The following TTW dual wave solder process is recommended:

1. Establish the correct preheat temperature, measured at a solder connection on the solder side of the pc board, required to properly activate the no-clean flux, for example +135 °C (+275 °F). This preheat temperature should be reached only during the last 20% of the travel through the preheat chamber to assure proper flux activation.
2. Set the solder wave temperature to be less than +100 °C (+180 °F) above the preheat temperature established in Step 1, for example, +135 °C (+275 °F) +100 °C (+180 °F) = +235 °C (+455 °F) maximum solder wave temperature.
3. Set the machine conveyor speed to limit the combined dwell time of an SMT LED component in the two solder waves to no more than 10 seconds.
4. Spray flux at room temperature.
5. Wave solder the pc board.
6. Allow the soldered pc board to cool to room temperature before handling.
7. Post solder cleaning is normally not necessary with the use of a no-clean flux.
8. Should post solder cleaning be included in the process, allow the soldered pc board to cool to either room temperature, for hand cleaning, or to the processing temperature of the in-line cleaning process.
9. For post solder cleaning, an in-line water cleaning process is recommended with water temperature and hot air dry temperature set between +60 °C (+140 °F) and +71 °C (+160 °F).

**[www.agilent.com/
semiconductors](http://www.agilent.com/semiconductors)**

For product information and a complete list of distributors, please go to our web site.

For technical assistance call:

Americas/Canada: +1 (800) 235-0312 or
(916) 788-6763

Europe: +49 (0) 6441 92460

China: 10800 650 0017

Hong Kong: (+65) 6756 2394

India, Australia, New Zealand: (+65) 6755 1939

Japan: (+81 3) 3335-8152(Domestic/International), or
0120-61-1280(Domestic Only)

Korea: (+65) 6755 1989

Singapore, Malaysia, Vietnam, Thailand, Philippines,
Indonesia: (+65) 6755 2044

Taiwan: (+65) 6755 1843

Data subject to change.

Copyright © 2003 Agilent Technologies, Inc.

Obsoletes: 5988-7835EN

July 24, 2003

5988-9462EN



Agilent Technologies