

GRM188R61E105KA12#

"#" indicates a package specification code.



< List of part numbers with package codes >
 GRM188R61E105KA12D , GRM188R61E105KA12J , GRM188R61E105KA12B

Shape

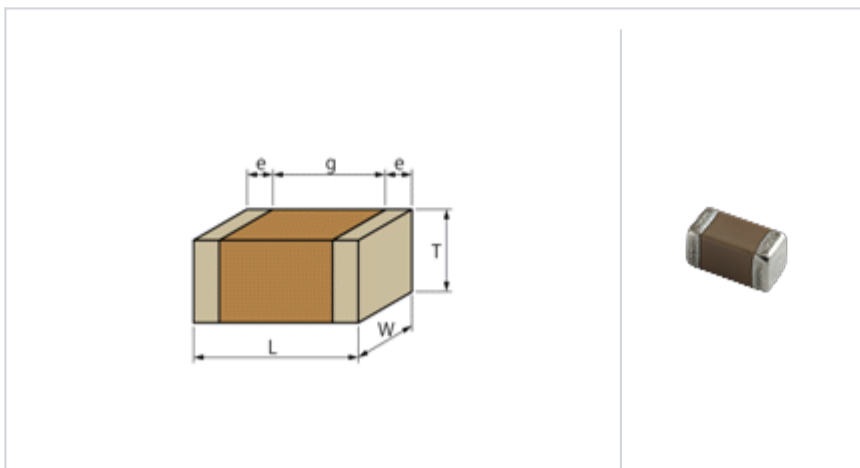

L size	1.6 ± 0.1mm
W size	0.8 ± 0.1mm
T size	0.8 ± 0.1mm
External terminal width e	0.2 to 0.5mm
Distance between external terminals g (Min.)	0.5mm
Size code in mm(inch)	1608 (0603)

References

Packaging	Specifications	Minimum quantity
D	Paper tape (180mm)	4000
J	Paper tape (330mm)	10000
B	Packing in bulk	1000

Mass (typ.)	
1 piece	6.3mg
Reel (180mm)	144g

Specifications

Capacitance	1.0µF ± 10%
Rated voltage	25Vdc
Temperature characteristics (complied standard)	X5R(EIA)
Capacitance change rate	± 15%
Temperature range of temperature characteristics	-55 to 85
Operating temperature range	-55 to 85

⚠ Attention

- 1.This datasheet is downloaded from the website of Murata Manufacturing Co., Ltd. Therefore, it ' s specifications are subject to change or our products in it may be discontinued without advance notice. Please check with our sales representatives or product engineers before ordering.
- 2.This datasheet has only typical specifications because there is no space for detailed specifications. Therefore, please review our product specifications or consult the approval sheet for product specifications before ordering.

▪ Frequency characteristics (ESR, Impedance)

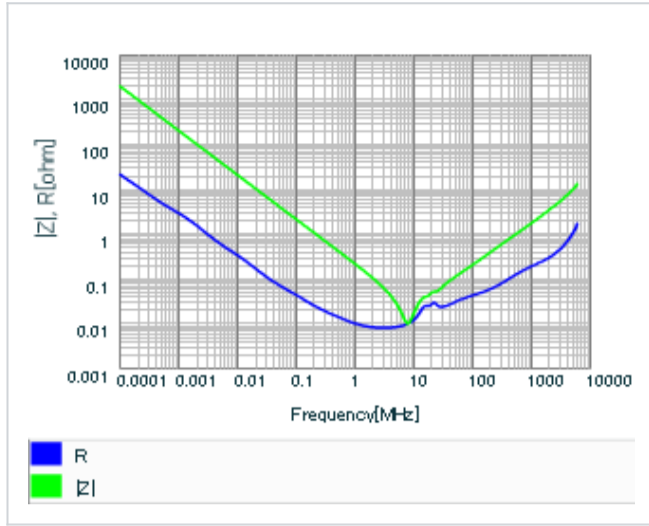

▪ S parameter (Smith chart S11)

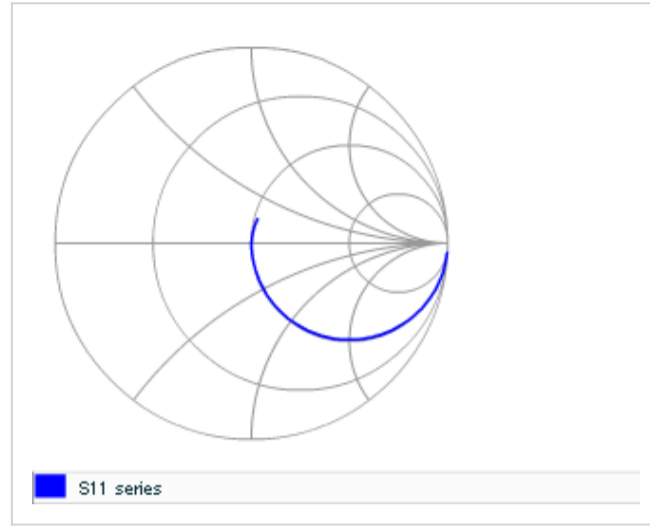

▪ DC bias characteristics

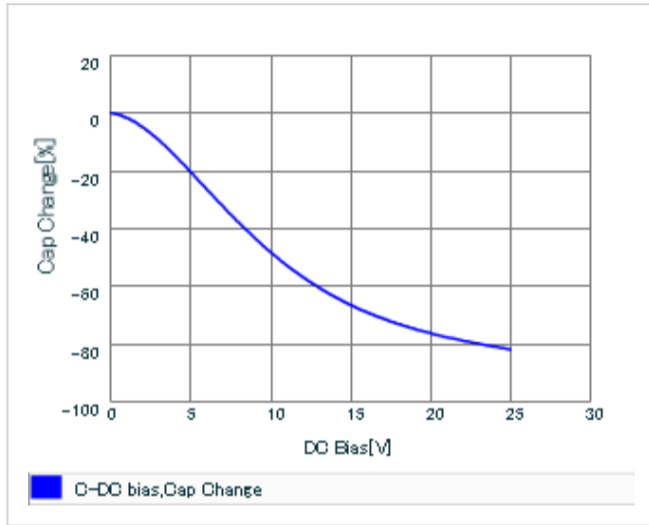

▪ AC voltage characteristics

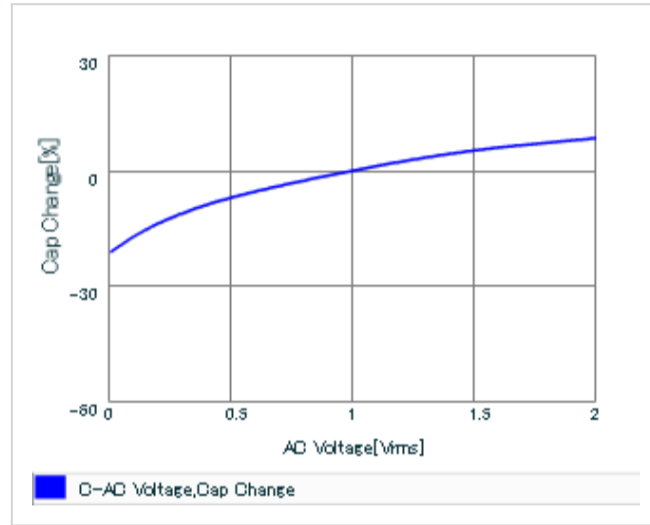

▪ Capacitance - temperature characteristics

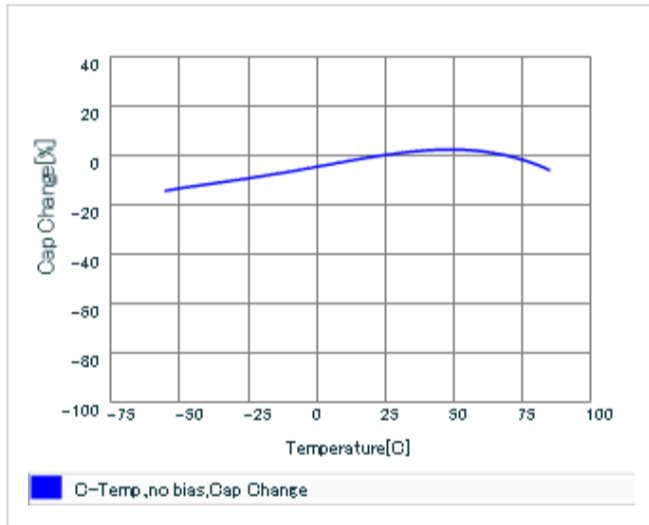

▪ Calorific property by ripple current

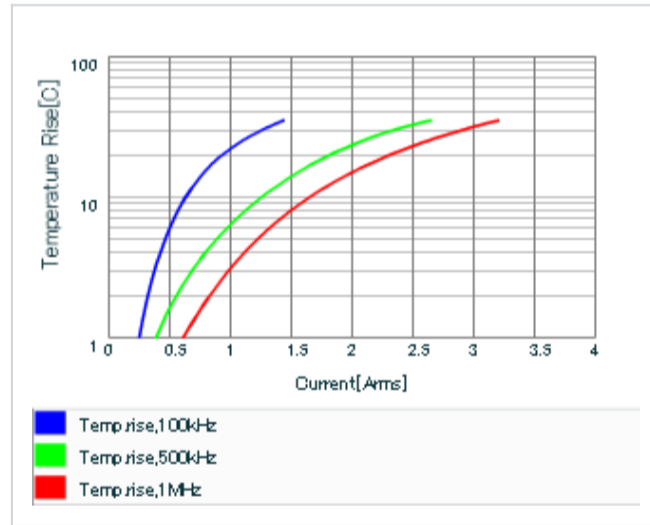

This PDF data has only typical specifications because there is no space for detailed specifications. Therefore, please review our product specifications or consult the approval sheet for product specifications before ordering.