

G172 Series

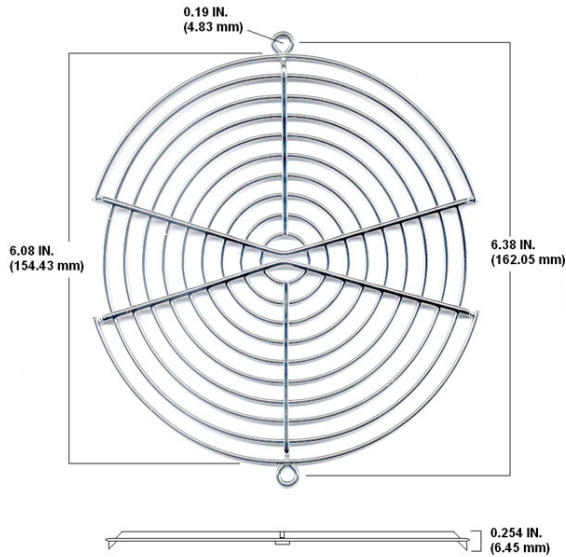

Fan Guards for 172mm Fan



PART NO. G172-10H

WIRE DIAMETER
RING DIA: 1.8mm
RIB DIA: 2.3mm
FINISH: BRIGHT NICKEL CHROME

PART NO. G172-10H/PK

10-PACK G172-10H GUARDS, BOXED

PART NO. G172-10HB

WIRE DIAMETER
RING DIA: 1.8mm
RIB DIA: 2.3mm
FINISH: BLACK

PART NO. G172-10HB/PK

10-PACK G172-10HB GUARDS, BOXED

NOTES:

1. MATERIAL: C1008 BRIGHT BASIC WIRE

2. WELD JOINTS TO WITHSTAND 88LBS PULL FORCE

3. GENERAL TOLERANCE UNLESS NOTED +/- 0.5mm

4. PART MEETS 6.35mm PLUG GAUGE TEST

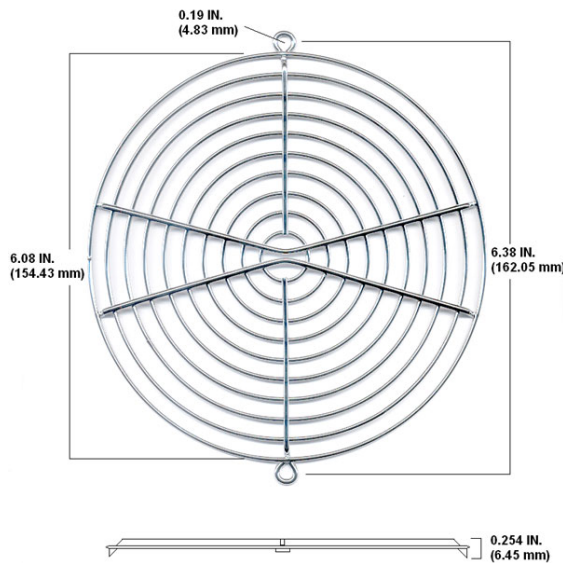

PART NO. G172-10HA

WIRE DIAMETER
RING DIA: 1.8mm
RIB DIA: 2.3mm
FINISH: BRIGHT NICKEL CHROME

PART NO. G172-10HA/PK

10-PACK G172-10H GUARDS, BOXED

PART NO. G172-10HAB

WIRE DIAMETER
RING DIA: 1.8mm
RIB DIA: 2.3mm
FINISH: BLACK

PART NO. G172-10HAB/PK

10-PACK G172-10HAB GUARDS, BOXED

NOTES:

1. MATERIAL: C1008 BRIGHT BASIC WIRE

2. WELD JOINTS TO WITHSTAND 88LBS PULL FORCE

3. GENERAL TOLERANCE UNLESS NOTED +/- 0.5mm

4. PART MEETS 6.35mm PLUG GAUGE TEST

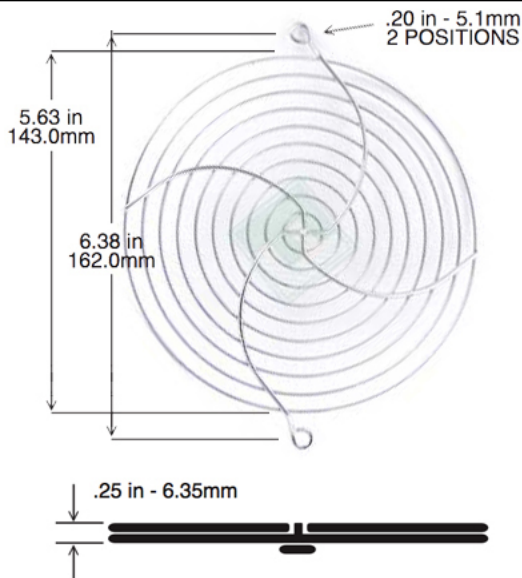

PART NO. G172-10LN

WIRE DIAMETER
RING DIA: 1.6mm
RIB DIA: 2.0mm
FINISH: BRIGHT NICKEL CHROME
LOWER NOISE

PART NO. G172-10LN/PK

10-PACK G172-10LN GUARDS, BOXED

NOTES:

1. MATERIAL: C1008 BRIGHT BASIC WIRE

2. WELD JOINTS TO WITHSTAND 88LBS PULL FORCE

3. GENERAL TOLERANCE UNLESS NOTED +/- 0.5mm

4. PART MEETS 6.35mm PLUG GAUGE TEST