



Is Now Part of



ON Semiconductor®

To learn more about ON Semiconductor, please visit our website at

www.onsemi.com

ON Semiconductor and the ON Semiconductor logo are trademarks of Semiconductor Components Industries, LLC dba ON Semiconductor or its subsidiaries in the United States and/or other countries. ON Semiconductor owns the rights to a number of patents, trademarks, copyrights, trade secrets, and other intellectual property. A listing of ON Semiconductor's product/patent coverage may be accessed at www.onsemi.com/site/pdf/Patent-Marking.pdf. ON Semiconductor reserves the right to make changes without further notice to any products herein. ON Semiconductor makes no warranty, representation or guarantee regarding the suitability of its products for any particular purpose, nor does ON Semiconductor assume any liability arising out of the application or use of any product or circuit, and specifically disclaims any and all liability, including without limitation special, consequential or incidental damages. Buyer is responsible for its products and applications using ON Semiconductor products, including compliance with all laws, regulations and safety requirements or standards, regardless of any support or applications information provided by ON Semiconductor. "Typical" parameters which may be provided in ON Semiconductor data sheets and/or specifications can and do vary in different applications and actual performance may vary over time. All operating parameters, including "Typicals" must be validated for each customer application by customer's technical experts. ON Semiconductor does not convey any license under its patent rights nor the rights of others. ON Semiconductor products are not designed, intended, or authorized for use as a critical component in life support systems or any FDA Class 3 medical devices or medical devices with a same or similar classification in a foreign jurisdiction or any devices intended for implantation in the human body. Should Buyer purchase or use ON Semiconductor products for any such unintended or unauthorized application, Buyer shall indemnify and hold ON Semiconductor and its officers, employees, subsidiaries, affiliates, and distributors harmless against all claims, costs, damages, and expenses, and reasonable attorney fees arising out of, directly or indirectly, any claim of personal injury or death associated with such unintended or unauthorized use, even if such claim alleges that ON Semiconductor was negligent regarding the design or manufacture of the part. ON Semiconductor is an Equal Opportunity/Affirmative Action Employer. This literature is subject to all applicable copyright laws and is not for resale in any manner.



August 2015

FDC658AP

Single P-Channel Logic Level PowerTrench[®] MOSFET

-30V, -4A, 50mΩ

General Description

This P-Channel Logic Level MOSFET is produced using Fairchild's advanced PowerTrench process. It has been optimized for battery power management applications.

Applications

- Battery management
- Load switch
- Battery protection
- DC/DC conversion

Features

- Max $r_{DS(on)}$ = 50 mΩ @ $V_{GS} = -10$ V, $I_D = -4$ A
- Max $r_{DS(on)}$ = 75 mΩ @ $V_{GS} = -4.5$ V, $I_D = -3.4$ A
- Low Gate Charge
- High performance trench technology for extremely low $r_{DS(on)}$
- RoHS Compliant

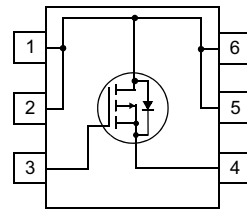
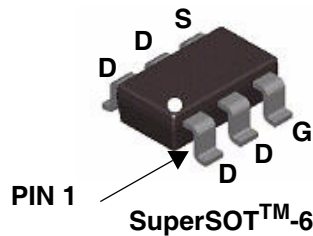

Absolute Maximum Ratings $T_A = 25^\circ\text{C}$ unless otherwise noted

Symbol	Parameter	Rated Value	Units
V_{DS}	Drain-Source Voltage	-30	V
V_{GS}	Gate-Source Voltage	±25	V
I_D	Drain Current - Continuous (Note 1a)	-4	A
	- Pulsed	-20	
P_D	Maximum Power dissipation (Note 1a)	1.6	W
	(Note 1b)	0.8	
T_J, T_{STG}	Operating and Storage Junction Temperature Range	-55 to +150	°C

Thermal Characteristics

$R_{\theta JA}$	Thermal Resistance, Junction-to-Ambient (Note 1a)	78	°C/W
$R_{\theta JC}$	Thermal Resistance, Junction-to-Case (Note 1)	30	°C/W

Package Marking and Ordering Information

Device Marking	Device	Reel Size	Tape Width	Quantity
.58A	FDC658AP	7inch	8mm	3000 units

FDC658AP Single P-Channel Logic Level PowerTrench[®] MOSFET

Electrical Characteristics $T_J = 25^\circ\text{C}$ unless otherwise noted

Symbol	Parameter	Test Conditions	Min	Typ	Max	Units
--------	-----------	-----------------	-----	-----	-----	-------

Off Characteristics

BV_{DSS}	Drain-Source Breakdown Voltage	$I_D = -250\mu\text{A}, V_{GS} = 0\text{V}$	-30			V
$\frac{\Delta BV_{DSS}}{\Delta T_J}$	Breakdown Voltage Temperature Coefficient	$I_D = -250\mu\text{A}$, Referenced to 25°C		-22		mV/ $^\circ\text{C}$
I_{DSS}	Zero Gate Voltage Drain Current	$V_{GS} = 0\text{V}, V_{DS} = -24\text{V}$			-1	μA
I_{GSS}	Gate-Body Leakage	$V_{GS} = \pm 25\text{V}, V_{DS} = 0\text{V}$			± 100	nA

On Characteristics (Note 2)

$V_{GS(TH)}$	Gate Threshold Voltage	$V_{DS} = V_{GS}, I_D = -250\mu\text{A}$	-1	-1.8	-3	V
$\frac{\Delta V_{GS(TH)}}{\Delta T_J}$	Gate Threshold Voltage Temperature Coefficient	$I_D = -250\mu\text{A}$, Referenced to 25°C		4		mV/ $^\circ\text{C}$
$r_{DS(on)}$	Static Drain-Source On-Resistance	$I_D = -4\text{A}, V_{GS} = -10\text{V}$		44	50	m Ω
		$I_D = -3.4\text{A}, V_{GS} = -4.5\text{V}$		67	75	
		$I_D = -4\text{A}, V_{GS} = -10\text{V}$, $T_J = 125^\circ\text{C}$		60	70	
$I_{D(ON)}$	On-State Drain Current	$V_{GS} = -10\text{V}, V_{DS} = -5\text{V}$	-20			A
g_{FS}	Forward Transconductance	$I_D = -4\text{A}, V_{DS} = -5\text{V}$		8.4		S

Dynamic Characteristics

C_{iss}	Input Capacitance	$V_{DS} = -15\text{V}, V_{GS} = 0\text{V}$, $f = 1\text{MHz}$		470	680	pF
C_{oss}	Output Capacitance			126	180	pF
C_{rss}	Reverse Transfer Capacitance			61	90	pF

Switching Characteristics (Note 2)

$t_{d(on)}$	Turn-On Delay Time	$V_{DD} = -15\text{V}, I_D = -1\text{A}$, $V_{GS} = -10\text{V}, R_{GEN} = 6\Omega$		7	14	ns
t_r	Turn-On Rise Time			12	22	ns
$t_{d(off)}$	Turn-Off Delay Time			16	29	ns
t_f	Turn-Off Fall Time			6	12	ns
Q_g	Total Gate Charge	$V_{DS} = -15\text{V}, I_D = -4\text{A}$, $V_{GS} = -5\text{V}$		6	8.1	nC
Q_{gs}	Gate-Source Charge			2.1		nC
Q_{gd}	Gate-Drain Charge			2		nC

Drain-Source Diode Characteristics and Maximum Ratings

I_S	Maximum Continuous Drain-Source Diode Forward Current			-1.3	A
V_{SD}	Drain-Source Diode Forward Voltage	$V_{GS} = 0\text{V}, I_S = -1.3\text{A}$ (Note 2)	-0.77	-1.2	V

Notes:

1: $R_{\theta JA}$ is the sum of the junction-to-case and case-to-ambient thermal resistance where the case thermal reference is defined as the solder mounting surface of the drain pins. $R_{\theta JC}$ is guaranteed by design while $R_{\theta CA}$ is determined by the user's board design.



a) 78°C/W when mounted on a 1 in^2 pad of 2 oz copper



b) 156°C/W when mounted on a minimum pad of 2 oz copper

Scale 1: 1 on letter size paper

2: Pulse Test: Pulse Width < 300 μs , Duty Cycle < 2.0%

Typical Characteristics

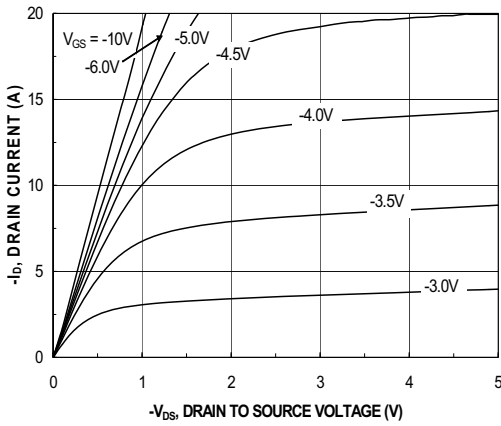

Figure 1. On-Region Characteristics

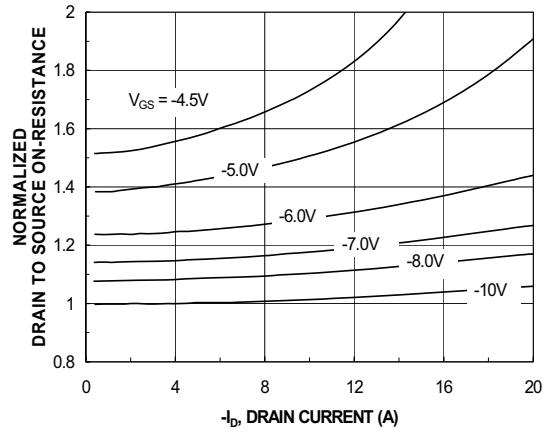

Figure 2. Normalized On-Resistance vs Drain Current and Gate Voltage

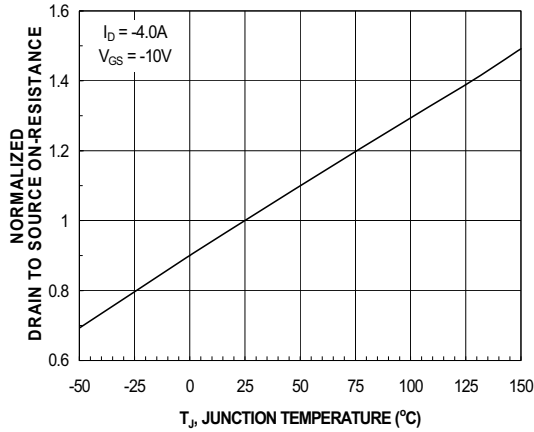

Figure 3. Normalized On-Resistance vs Junction Temperature

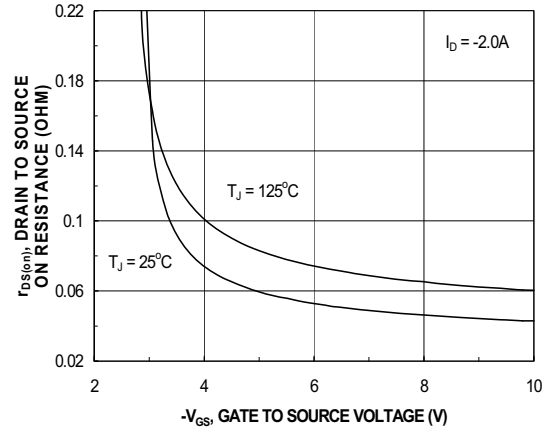

Figure 4. On-Resistance vs Gate to Source Voltage

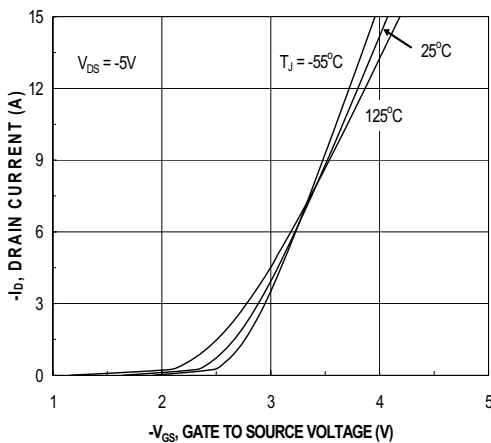

Figure 5. Transfer Characteristics

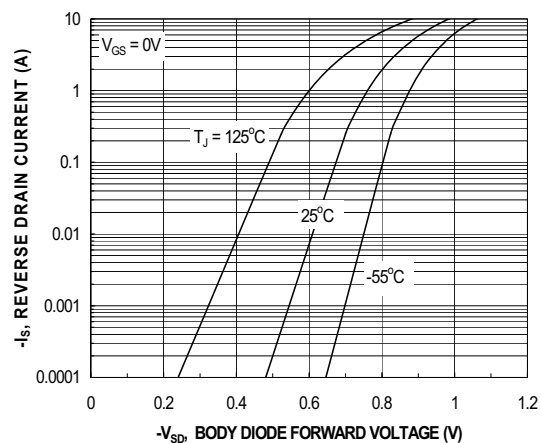

Figure 6. Source to Drain Diode Forward Voltage vs Source Current

Typical Characteristics

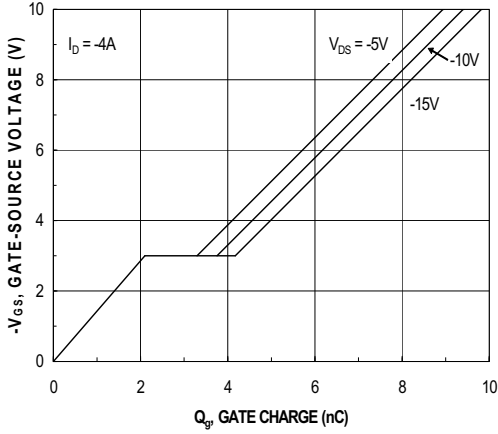

Figure 7. Gate Charge Characteristics

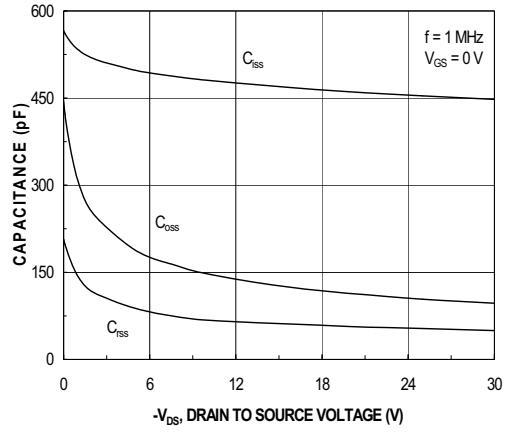

Figure 8. Capacitance vs Drain to Source Voltage

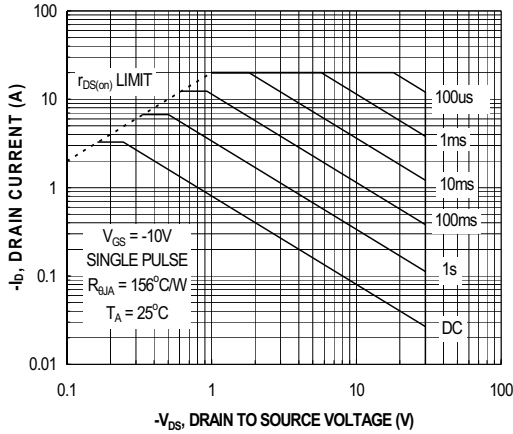

Figure 9. Forward Bias Safe Operating Area

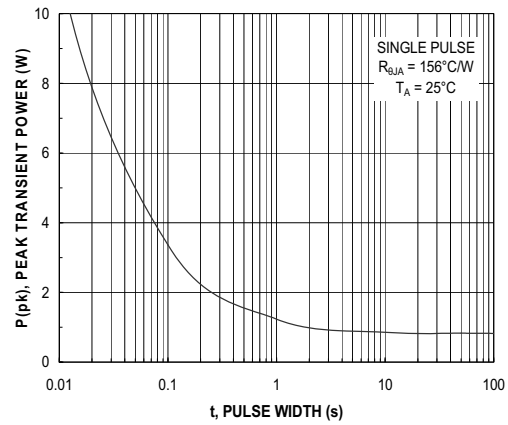

Figure 10. Single Pulse Maximum Power Dissipation

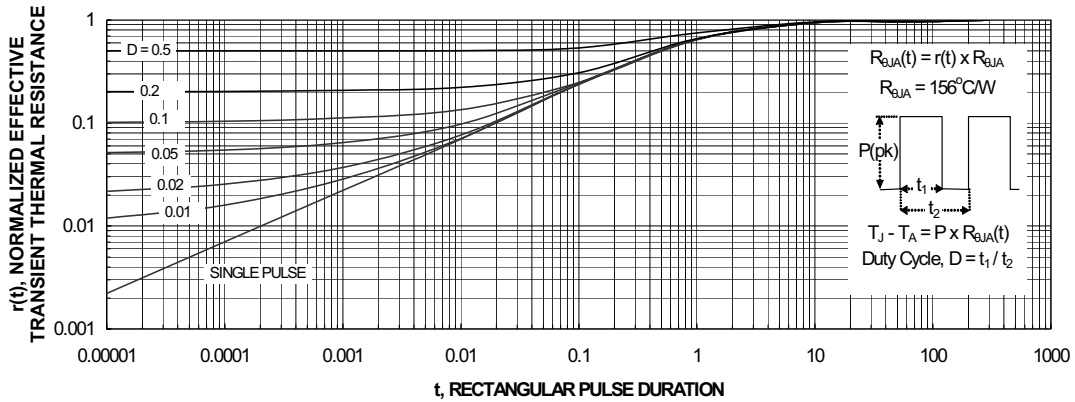







Figure 11. Transient Thermal Response Curve

Thermal characterization performed using the conditions described in Note 1b. Transient thermal response will change depending on the circuit board design.



TRADEMARKS

The following includes registered and unregistered trademarks and service marks, owned by Fairchild Semiconductor and/or its global subsidiaries, and is not intended to be an exhaustive list of all such trademarks.

- AccuPower™
- AttitudeEngine™
- Awinda®
- AX-CAP®*
- BitSiC™
- Build it Now™
- CorePLUS™
- CorePOWER™
- CROSSVOLT™
- CTL™
- Current Transfer Logic™
- DEUXPEED®
- Dual Cool™
- EcoSPARK®
- EfficientMax™
- ESBC™
-  Fairchild®
- Fairchild Semiconductor®
- FACT Quiet Series™
- FACT®
- FastCore™
- FETBench™
- FPS™
- F-PFS™
- FRFET®
- Global Power ResourceSM
- GreenBridge™
- Green FPS™
- Green FPS™ e-Series™
- Gmax™
- GTO™
- IntelliMAX™
- ISOPLANAR™
- Making Small Speakers Sound Louder and Better™
- MegaBuck™
- MICROCOUPLER™
- MicroFET™
- MicroPak™
- MicroPak2™
- MillerDrive™
- MotionMax™
- MotionGrid®
- MTI®
- MTX®
- MVN®
- mWSaver®
- OptoHiT™
- OPTOLOGIC®
- OPTOPLANAR®
- ®
- Power Supply WebDesigner™
- PowerTrench®
- PowerXS™
- Programmable Active Droop™
- QFET®
- QS™
- Quiet Series™
- RapidConfigure™
- ™
- Saving our world, 1mW/W/kW at a time™
- SignalWise™
- SmartMax™
- SMART START™
- Solutions for Your Success™
- SPM®
- STEALTH™
- SuperFET®
- SuperSOT™-3
- SuperSOT™-6
- SuperSOT™-8
- SupreMOS®
- SyncFET™
- Sync-Lock™
-  SYSTEM GENERAL®
- TinyBoost®
- TinyBuck®
- TinyCalc™
- TinyLogic®
- TINYOPTO™
- TinyPower™
- TinyPWM™
- TinyWire™
- TranSiC™
- TriFault Detect™
- TRUECURRENT®*
- µSerDes™
-  SerDes™
- UHC®
- Ultra FRFET™
- UniFET™
- VCX™
- VisualMax™
- VoltagePlus™
- XS™
- Xsens™
- 仙童™

* Trademarks of System General Corporation, used under license by Fairchild Semiconductor.

DISCLAIMER

FAIRCHILD SEMICONDUCTOR RESERVES THE RIGHT TO MAKE CHANGES WITHOUT FURTHER NOTICE TO ANY PRODUCTS HEREIN TO IMPROVE RELIABILITY, FUNCTION, OR DESIGN. TO OBTAIN THE LATEST, MOST UP-TO-DATE DATASHEET AND PRODUCT INFORMATION, VISIT OUR WEBSITE AT [HTTP://WWW.FAIRCHILDSEMI.COM](http://www.fairchildsemi.com). FAIRCHILD DOES NOT ASSUME ANY LIABILITY ARISING OUT OF THE APPLICATION OR USE OF ANY PRODUCT OR CIRCUIT DESCRIBED HEREIN; NEITHER DOES IT CONVEY ANY LICENSE UNDER ITS PATENT RIGHTS, NOR THE RIGHTS OF OTHERS. THESE SPECIFICATIONS DO NOT EXPAND THE TERMS OF FAIRCHILD'S WORLDWIDE TERMS AND CONDITIONS, SPECIFICALLY THE WARRANTY THEREIN, WHICH COVERS THESE PRODUCTS.

AUTHORIZED USE

Unless otherwise specified in this data sheet, this product is a standard commercial product and is not intended for use in applications that require extraordinary levels of quality and reliability. This product may not be used in the following applications, unless specifically approved in writing by a Fairchild officer: (1) automotive or other transportation, (2) military/aerospace, (3) any safety critical application – including life critical medical equipment – where the failure of the Fairchild product reasonably would be expected to result in personal injury, death or property damage. Customer's use of this product is subject to agreement of this Authorized Use policy. In the event of an unauthorized use of Fairchild's product, Fairchild accepts no liability in the event of product failure. In other respects, this product shall be subject to Fairchild's Worldwide Terms and Conditions of Sale, unless a separate agreement has been signed by both Parties.

ANTI-COUNTERFEITING POLICY

Fairchild Semiconductor Corporation's Anti-Counterfeiting Policy. Fairchild's Anti-Counterfeiting Policy is also stated on our external website, www.fairchildsemi.com, under Terms of Use

Counterfeiting of semiconductor parts is a growing problem in the industry. All manufacturers of semiconductor products are experiencing counterfeiting of their parts. Customers who inadvertently purchase counterfeit parts experience many problems such as loss of brand reputation, substandard performance, failed applications, and increased cost of production and manufacturing delays. Fairchild is taking strong measures to protect ourselves and our customers from the proliferation of counterfeit parts. Fairchild strongly encourages customers to purchase Fairchild parts either directly from Fairchild or from Authorized Fairchild Distributors who are listed by country on our web page cited above. Products customers buy either from Fairchild directly or from Authorized Fairchild Distributors are genuine parts, have full traceability, meet Fairchild's quality standards for handling and storage and provide access to Fairchild's full range of up-to-date technical and product information. Fairchild and our Authorized Distributors will stand behind all warranties and will appropriately address any warranty issues that may arise. Fairchild will not provide any warranty coverage or other assistance for parts bought from Unauthorized Sources. Fairchild is committed to combat this global problem and encourage our customers to do their part in stopping this practice by buying direct or from authorized distributors.

PRODUCT STATUS DEFINITIONS

Definition of Terms

Datasheet Identification	Product Status	Definition
Advance Information	Formative / In Design	Datasheet contains the design specifications for product development. Specifications may change in any manner without notice.
Preliminary	First Production	Datasheet contains preliminary data; supplementary data will be published at a later date. Fairchild Semiconductor reserves the right to make changes at any time without notice to improve design.
No Identification Needed	Full Production	Datasheet contains final specifications. Fairchild Semiconductor reserves the right to make changes at any time without notice to improve the design.
Obsolete	Not In Production	Datasheet contains specifications on a product that is discontinued by Fairchild Semiconductor. The datasheet is for reference information only.

Rev. I76