

# EMM5834X

## Ku / K-Band Power Amplifier MMIC

### FEATURES

- Output Power; P1dB = 26 dBm (Typ.)
- High Gain; G1dB = 23 dB(Typ.)
- Wide Frequency Band ; 12.7 - 27.0 GHz
- Impedance Matched Zin/Zout = 50Ω

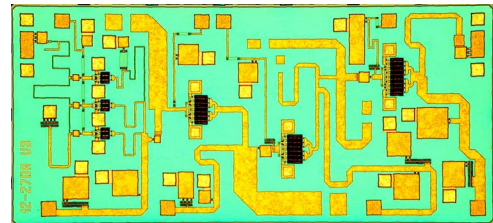

### DESCRIPTION

The EMM5834X is a wide band power amplifier MMIC that contains a four stage amplifier, internally matched, for standard communications band in 12.7 to 27.0GHz frequency range. This product is well suited for point-to-point radio applications.

Eudyna's stringent Quality Assurance Program assures the highest reliability and consistent performance.

### ABSOLUTE MAXIMUM RATING

Item	Symbol	Rating	Unit
Drain-Source Voltage	V <sub>DD</sub>	10	V
Gate-Source Voltage	V <sub>GG</sub>	-3	V
Input Power	P <sub>in</sub>	16	dBm
Storage Temperature	T <sub>stg</sub>	-55 to +125	°C

### RECOMMENDED OPERATING CONDITIONS

Item	Symbol	Conditions	Unit
Drain-Source Voltage	V <sub>DD</sub>	<=6	V
Input Power	P <sub>in</sub>	<=6	dBm
Operating Backside Temperature	Top	-40 to +85	°C

This product should be hermetically packaged.

### ELECTRICAL CHARACTERISTICS (Ambient Temperature Ta=25°C)

Item	Symbol	Test Conditions	Limits			Unit
			Min.	Typ.	Max.	
Frequency Range	f	V <sub>DD</sub> =6V	12.7	-	27	GHz
Output Power at 1dB G.C.P.	P <sub>1dB</sub>	I <sub>DD</sub> =300mA typ.	23	26	-	dBm
Power Gain at 1dB G.C.P.	G <sub>1dB</sub>		19	23	-	dB
Power-added Efficiency at 1dB G.C.P.	η <sub>add</sub>		-	18	-	%
Third Order Intermodulation*	IM <sub>3</sub>	* :Δf=10MHz ,	-26	-35	-	dBc
Drain Current at 1dB G.C.P.	I <sub>DD</sub>	2-Tone Test,	-	370	600	mA
Input Return Loss (at Pin=-20dBm)	RL <sub>in</sub>	P <sub>out</sub> =15dBm S.C.L.	-	-10	-	dB
Output Return Loss (at Pin=-20dBm)	RL <sub>out</sub>		-	-10	-	dB

Note : RF parameter sample size 10pcs. Criteria(accept/reject)=(0/1)

G.C.P.:Gain Compression Point

S.C.L.:Single Carrier Level

ESD	Class 0	~ 199V
-----	---------	--------

Note : Based on EIAJ ED-4701 C-111A(C=100pF, R=1.5Kohm)

# EMM5834X

## Ku / K-band Power Amplifier MMIC

Output Power vs. Frequency  
@ VDD=6V, IDD(DC)=300mA

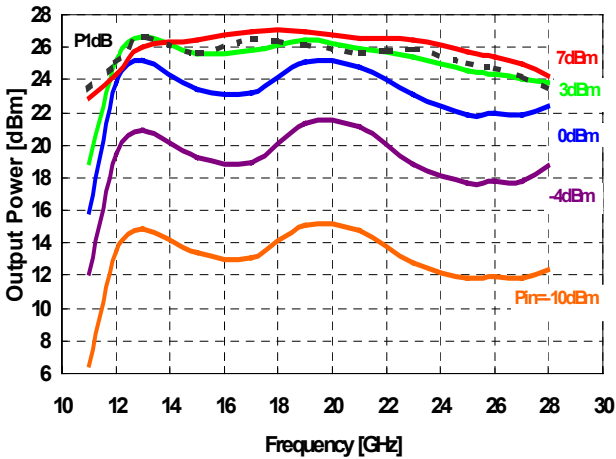

Output Power, Drain Current vs. Input Power  
@ VDD=6V, IDD(DC)=300mA

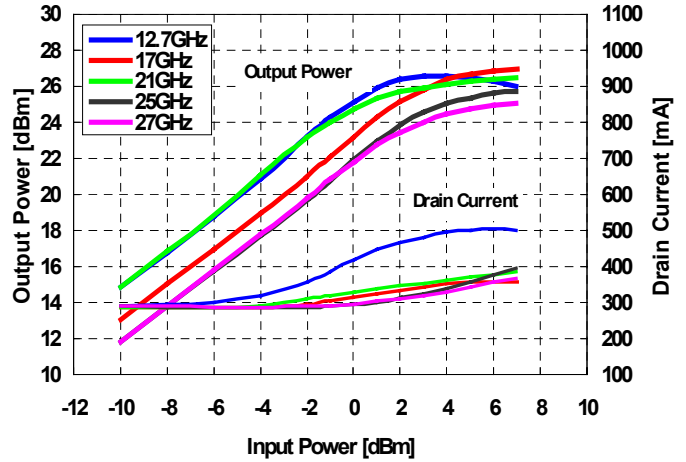

Power Added Efficiency vs. Frequency  
@ VDD=6V, IDD(DC)=300mA

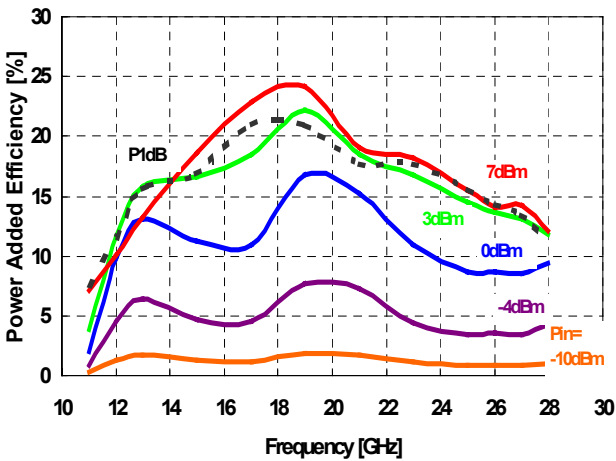

IMD vs. Output Power  
@ VDD=6V, IDD(DC)=300mA

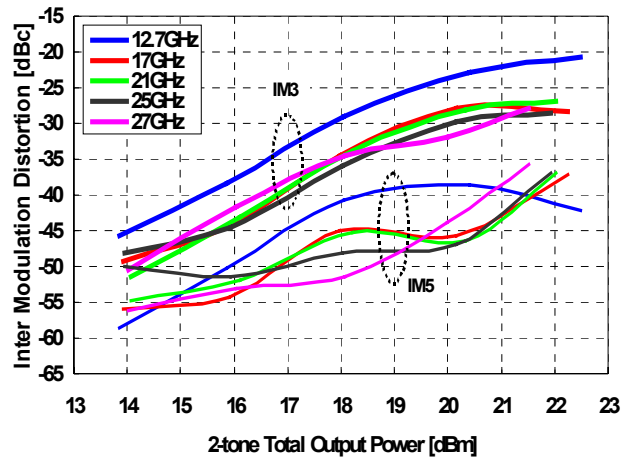

---



---



---

# EMM5834X

## Ku / K-Band Power Amplifier MMIC

**IMD vs. Frequency**  
 @VDD=6V, IDD(DC)=300mA, Pou=15dBm S.C.L

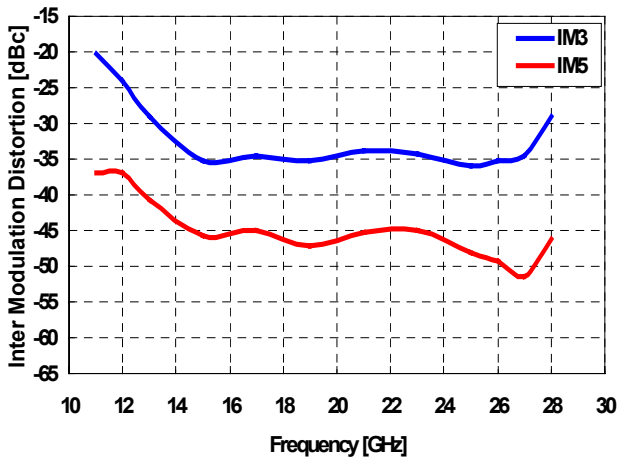

**Output Power, Gain vs. Drain Voltage**  
 @IDD(DC)=300mA

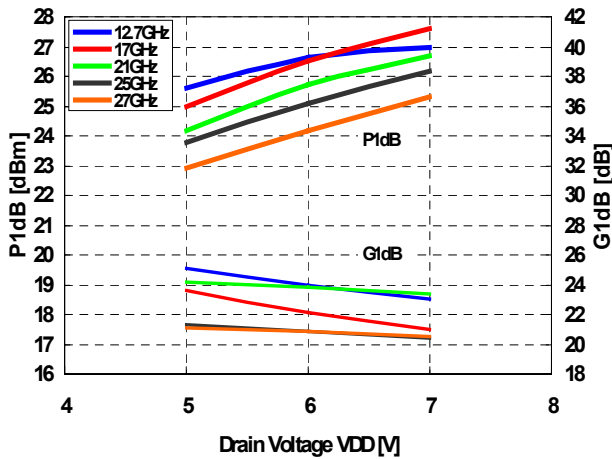

**Output Power, Gain vs. Drain Current**  
 @VDD=6V

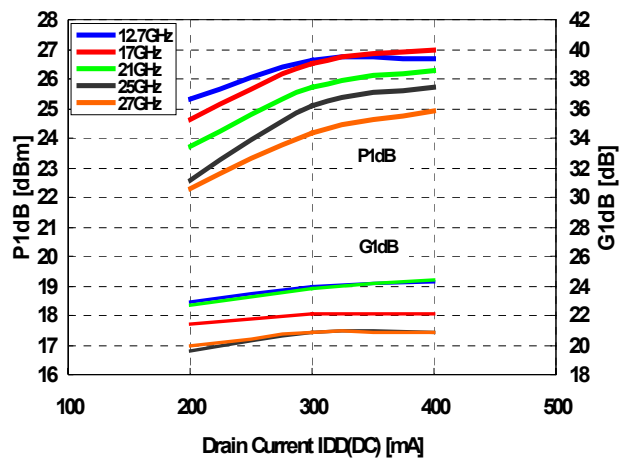

# EMM5834X

## Ku / K-band Power Amplifier MMIC

Output Power, Drain Current vs. Input Power  
by Drain Voltage  
@f=12.7GHz, IDD(DC)=300mA

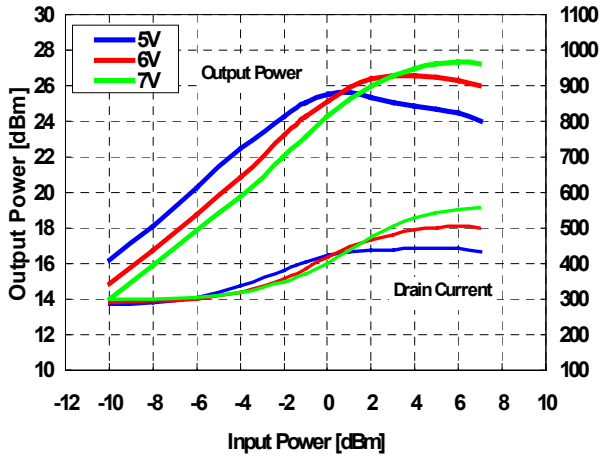

Output Power, Drain Current vs. Input Power  
by Drain Voltage  
@f=17GHz, IDD(DC)=300mA

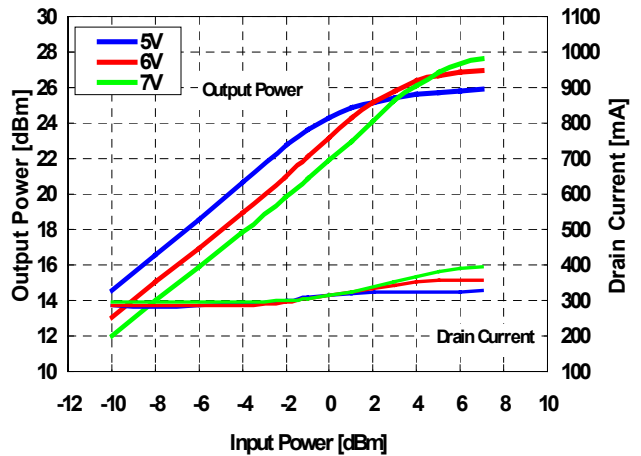

Output Power, Drain Current vs. Input Power  
by Drain Voltage  
@f=21GHz, IDD(DC)=300mA

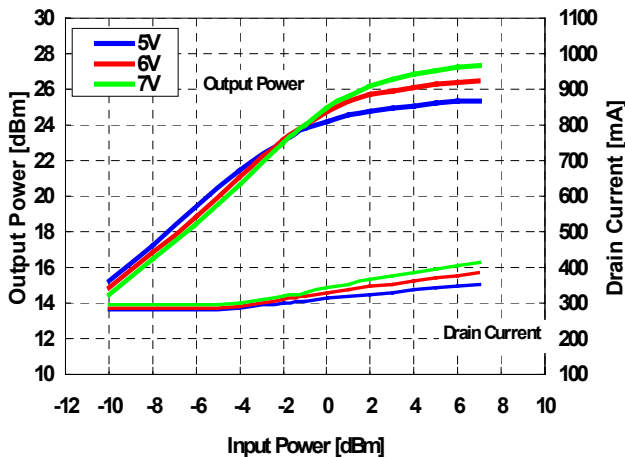

Output Power, Drain Current vs. Input Power  
by Drain Voltage  
@f=27GHz, IDD(DC)=300mA

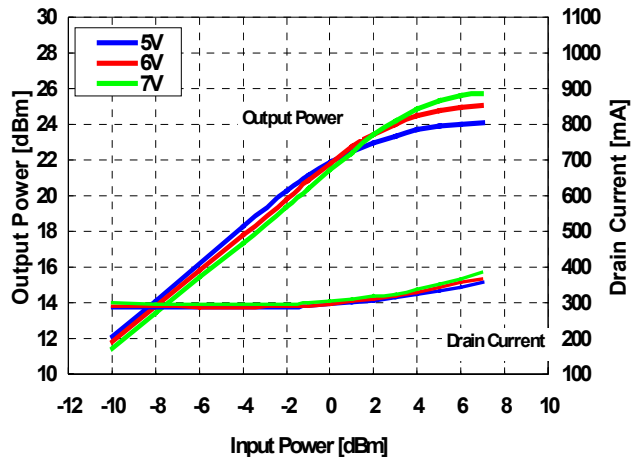

---

---

# EMM5834X

## Ku / K-Band Power Amplifier MMIC

Output Power, Drain Current vs. Input Power  
by Drain Current  
@f=12.7GHz, VDD=6V

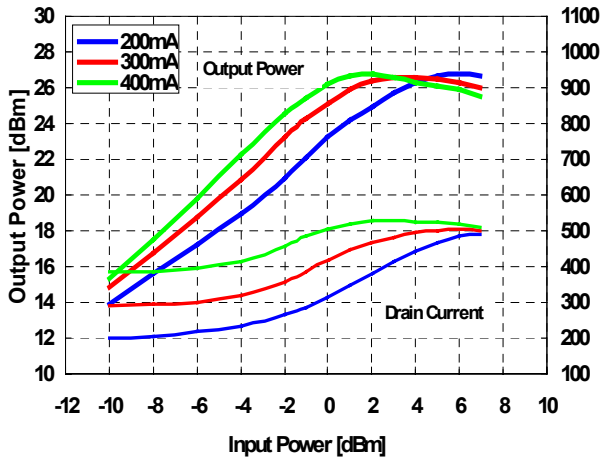

Output Power, Drain Current vs. Input Power  
by Drain Current  
@f=17GHz, VDD=6V

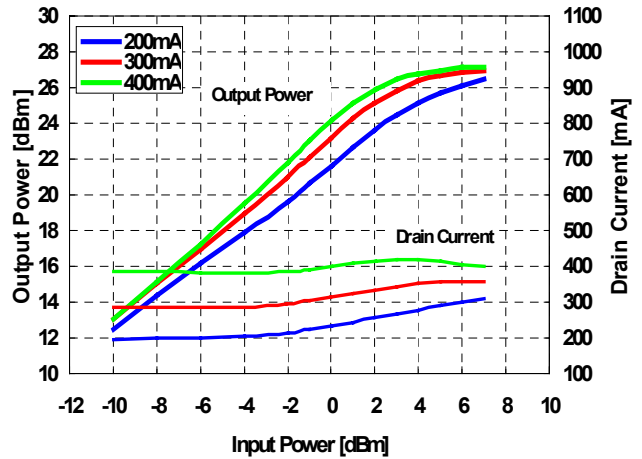

Output Power, Drain Current vs. Input Power  
by Drain Current  
@f=21GHz, VDD=6V

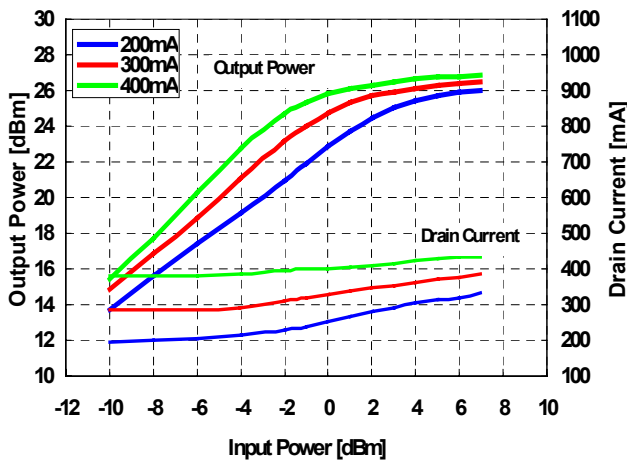

Output Power, Drain Current vs. Input Power  
by Drain Current  
@f=27GHz, VDD=6V

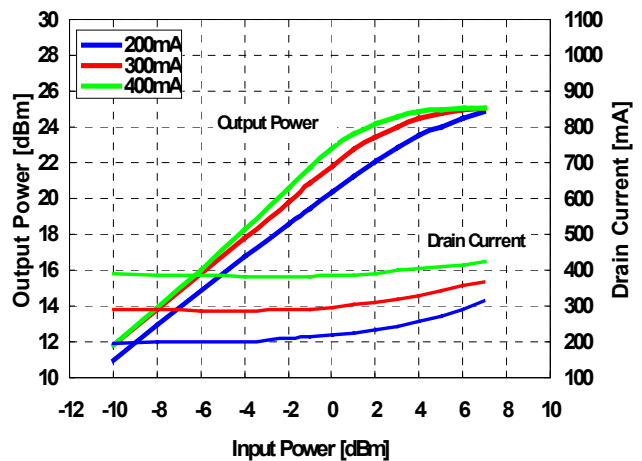

# EMM5834X

## Ku / K-band Power Amplifier MMIC

IMD vs. Output Power by Drain Voltage  
@f=12.7GHz, IDD(DC)=300mA

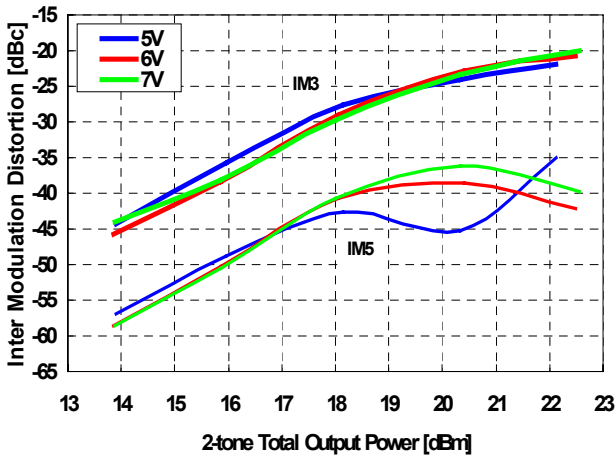

IMD vs. Output Power by Drain Voltage  
@f=17GHz, IDD(DC)=300mA

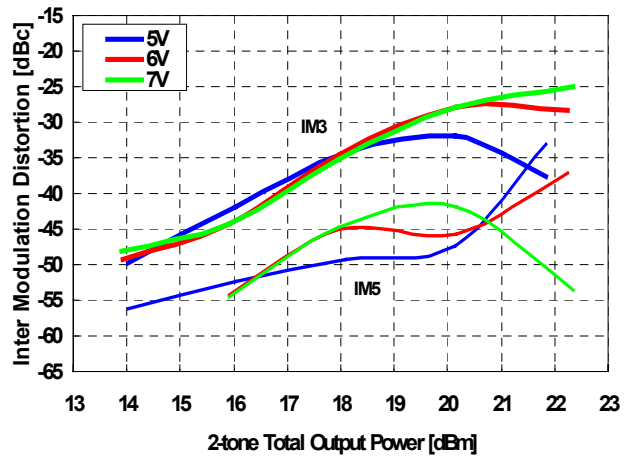

IMD vs. Output Power by Drain Voltage  
@f=21GHz, IDD(DC)=300mA

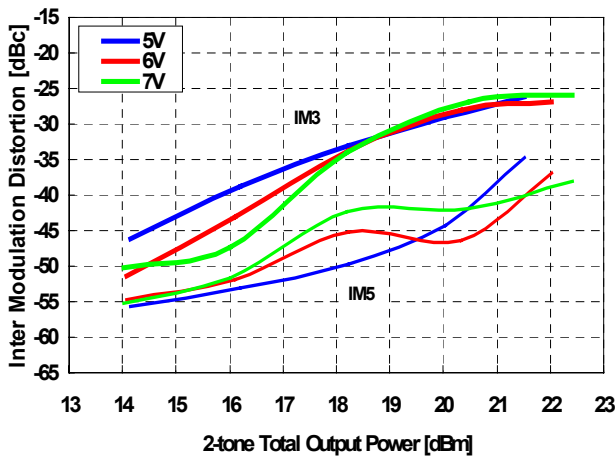

IMD vs. Output Power by Drain Voltage  
@f=27GHz, IDD(DC)=300mA

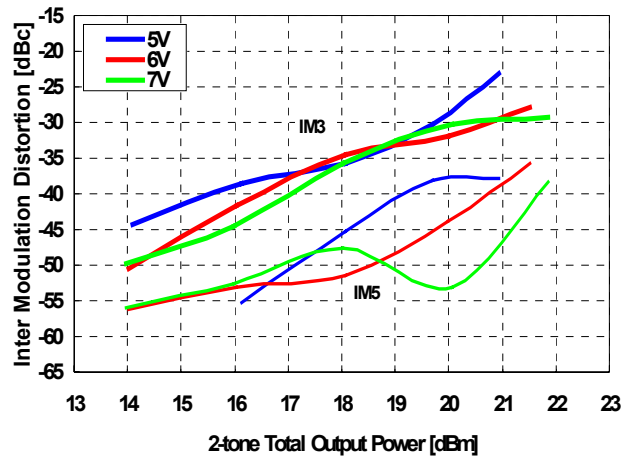

# EMM5834X

## Ku / K-Band Power Amplifier MMIC

IMD vs. Output Power by Drain Current

@f=12.7GHz, VDD=6V

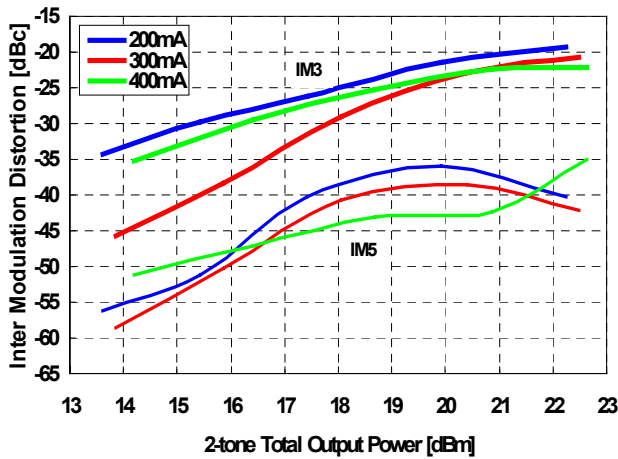

IMD vs. Output Power by Drain Current

@f=17GHz, VDD=6V

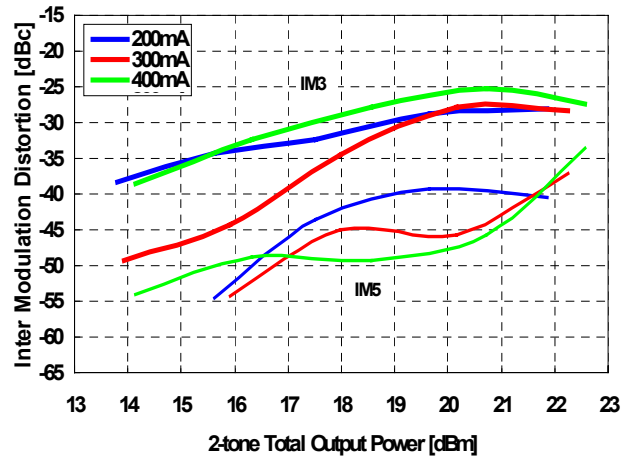

IMD vs. Output Power by Drain Current

@f=21GHz, VDD=6V

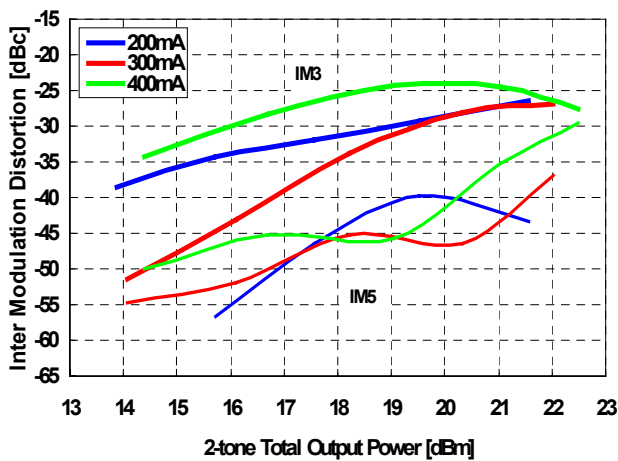

IMD vs. Output Power by Drain Current

@f=27GHz, VDD=6V

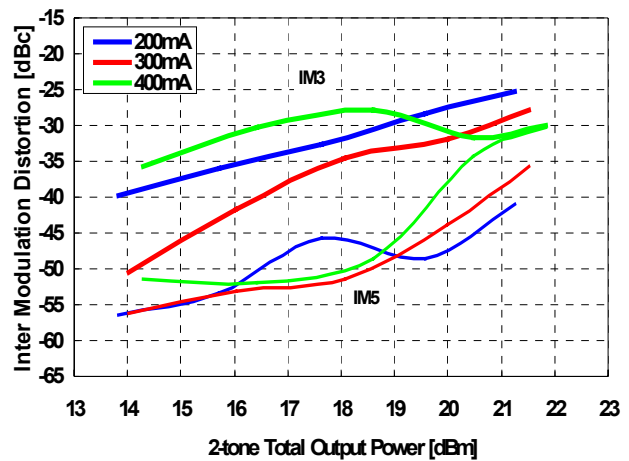

# EMM5834X

Ku / K-band Power Amplifier MMIC

## ■ S-Parameter

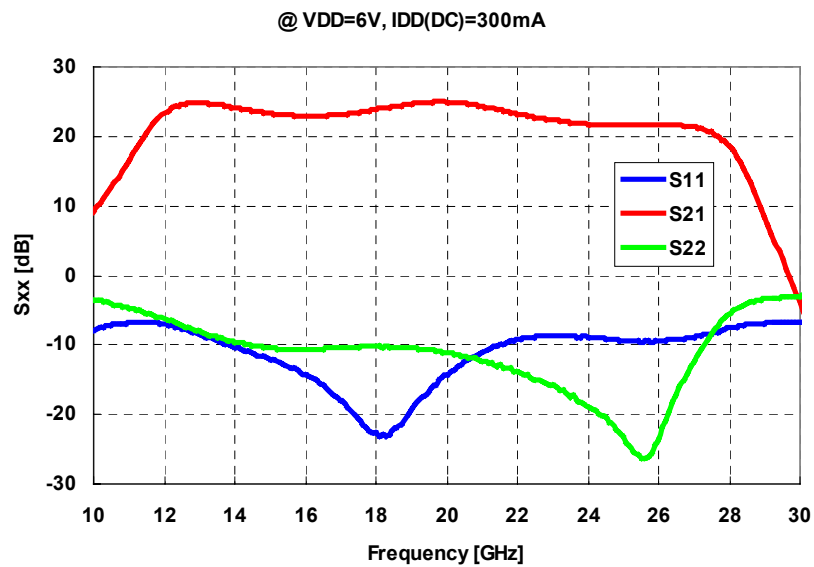
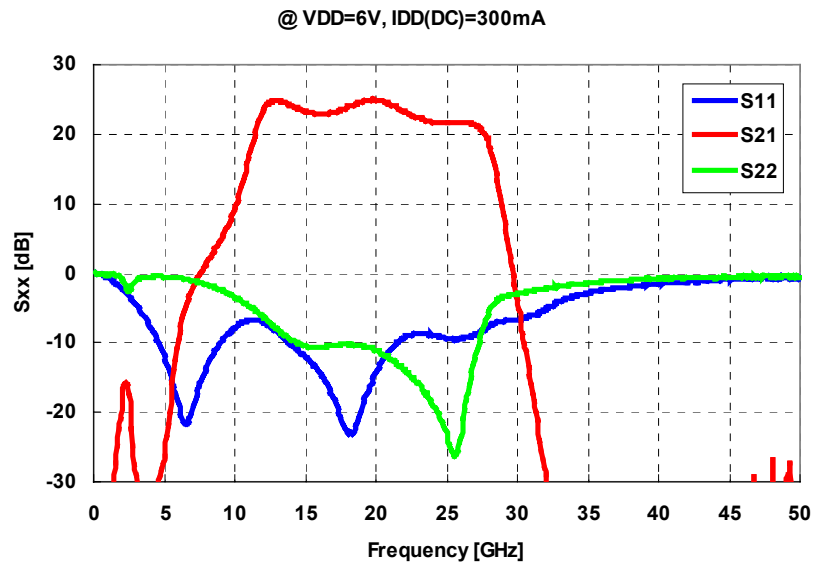



# EMM5834X

## Ku / K-Band Power Amplifier MMIC

### ■ S-Parameter

Freq. GHz	S11		S21		S12		S22	
	Mag.	Ang.	Mag.	Ang.	Mag.	Ang.	Mag.	Ang.
1.0	0.9364	-42.16	0.0173	91.32	0.0001	90.00	0.9705	-48.09
2.0	0.7812	-81.39	0.0866	-95.26	0.0001	-171.87	0.9164	-91.14
3.0	0.6008	-117.15	0.0361	63.31	0.0001	-131.99	0.8766	-108.46
4.0	0.4254	-151.08	0.0114	92.76	0.0001	95.71	0.9449	-135.96
5.0	0.2654	172.75	0.0496	148.46	0.0001	26.57	0.9470	-158.24
6.0	0.1382	120.00	0.4097	102.31	0.0000	90.00	0.9345	-178.20
7.0	0.1247	29.61	0.8893	16.24	0.0001	-63.43	0.8907	162.82
8.0	0.2184	-24.49	1.2973	-44.79	0.0001	22.62	0.8341	144.85
9.0	0.3199	-56.88	1.8931	-92.65	0.0003	43.73	0.7652	126.73
10.0	0.4069	-84.14	3.2336	-132.46	0.0001	118.30	0.6859	107.56
11.0	0.4609	-110.53	7.8616	176.68	0.0002	-114.44	0.6031	87.01
12.0	0.4482	-137.09	16.5903	90.45	0.0003	85.43	0.5160	63.83
12.5	0.4190	-148.66	18.7073	43.74	0.0002	122.91	0.4739	51.49
13.0	0.3791	-158.44	18.8635	1.56	0.0002	171.47	0.4301	38.34
13.5	0.3415	-166.35	18.2229	-36.28	0.0001	-51.34	0.3942	25.44
14.0	0.3117	-173.16	17.3261	-70.47	0.0004	99.46	0.3656	11.48
14.5	0.2884	179.83	16.5197	-101.96	0.0002	-148.39	0.3443	-2.57
15.0	0.2649	172.43	15.9096	-131.47	0.0002	105.95	0.3294	-16.42
15.5	0.2456	163.53	15.5321	-159.70	0.0006	-141.04	0.3160	-30.62
16.0	0.2197	152.38	15.3884	172.80	0.0002	177.27	0.3108	-44.25
16.5	0.1924	138.65	15.4297	145.60	0.0001	116.57	0.3091	-56.59
17.0	0.1604	123.63	15.7534	118.68	0.0000	-180.00	0.3081	-69.08
17.5	0.1372	102.04	16.2360	91.14	0.0003	-66.50	0.3067	-80.34
18.0	0.1166	77.07	16.9396	63.15	0.0021	29.03	0.3047	-91.07
18.5	0.1107	40.95	17.7663	33.76	0.0005	105.95	0.3009	-100.77
19.0	0.1270	10.27	18.5339	3.08	0.0005	-86.27	0.2931	-110.10
19.5	0.1570	-18.52	18.9621	-28.82	0.0005	87.84	0.2837	-119.04
20.0	0.1943	-38.14	18.9627	-61.17	0.0007	15.83	0.2716	-126.66
20.5	0.2368	-56.50	18.3970	-93.92	0.0004	-173.37	0.2530	-134.34
21.0	0.2787	-74.08	17.3632	-125.68	0.0006	-155.30	0.2298	-141.02
21.5	0.3149	-90.70	16.3173	-156.67	0.0004	-152.85	0.2089	-146.80
22.0	0.3427	-107.39	15.1908	173.17	0.0004	157.48	0.1868	-151.92
22.5	0.3682	-124.45	14.2478	143.68	0.0004	138.01	0.1610	-156.86
23.0	0.3781	-141.04	13.4796	114.33	0.0004	126.87	0.1424	-160.66
23.5	0.3842	-158.57	12.8187	84.98	0.0005	128.66	0.1159	-166.49
24.0	0.3812	-176.04	12.3604	55.18	0.0005	93.30	0.0939	-171.74
24.5	0.3794	165.28	12.0174	24.95	0.0006	75.47	0.0726	-179.61
25.0	0.3757	145.99	11.8535	-6.54	0.0006	96.01	0.0509	162.79
25.5	0.3775	125.86	11.8023	-39.56	0.0005	62.95	0.0419	122.93
26.0	0.3830	105.17	11.8585	-74.57	0.0003	43.60	0.0632	74.85
26.5	0.3962	84.89	12.0356	-112.74	0.0004	-30.96	0.1152	51.97
27.0	0.4087	65.61	12.1294	-154.82	0.0005	-67.22	0.1983	37.78
27.5	0.4269	48.48	11.9840	157.33	0.0002	57.09	0.3150	23.65
28.0	0.4490	33.54	10.9988	101.22	0.0001	-82.87	0.4673	7.13
29.0	0.5021	6.64	4.4476	-20.99	0.0002	-106.39	0.6835	-33.61
30.0	0.5071	-13.97	1.0263	-105.33	0.0000	26.57	0.7080	-55.94
31.0	0.5147	-25.92	0.2519	-167.14	0.0003	-178.03	0.7314	-69.40
32.0	0.5508	-31.91	0.0601	134.22	0.0007	-105.26	0.7604	-80.08
33.0	0.6245	-39.98	0.0042	87.96	0.0004	113.96	0.7954	-88.22
34.0	0.6836	-50.00	0.0020	-49.58	0.0004	64.09	0.8141	-95.73
35.0	0.7313	-57.97	0.0038	157.75	0.0001	55.01	0.8355	-102.17
36.0	0.7485	-65.77	0.0053	165.16	0.0003	-28.18	0.8564	-107.84
37.0	0.7731	-72.50	0.0026	-119.47	0.0005	-28.52	0.8650	-113.51
38.0	0.8007	-78.20	0.0034	71.83	0.0003	47.86	0.8752	-117.97
39.0	0.8122	-83.09	0.0078	-50.87	0.0008	-177.95	0.9058	-121.72
40.0	0.8263	-88.26	0.0063	-108.00	0.0009	66.63	0.9189	-127.13

# EMM5834X

## Ku / K-band Power Amplifier MMIC

### ■ Channel Temperature rise and MTTF

$\Delta T_{ch}$  vs. Drain Voltage  
(Reference)

$I_{DD}=300\text{mA}$

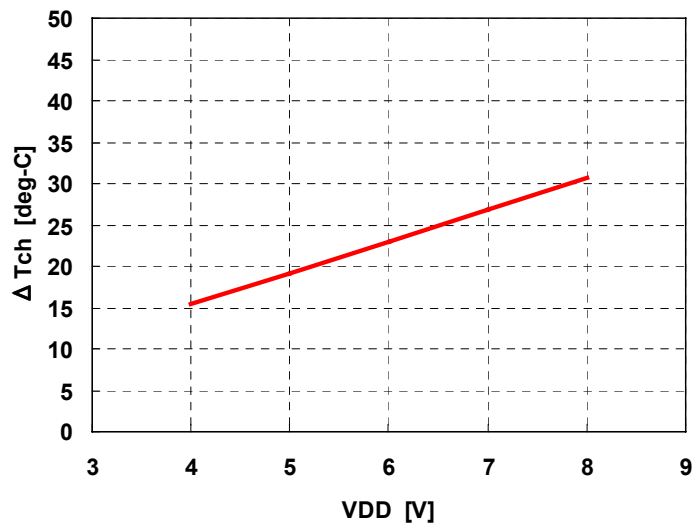

MTTF vs.  $T_{ch}$

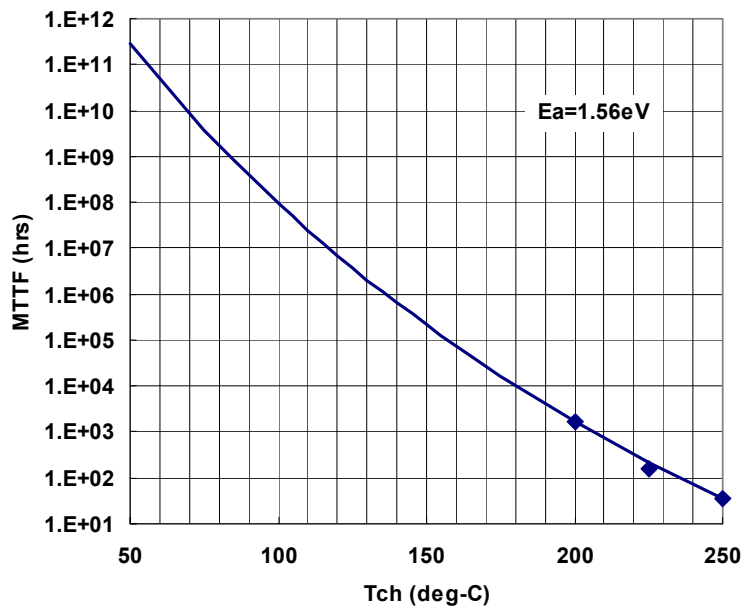

---

---

---

# EMM5834X

Ku / K-Band Power Amplifier MMIC

■ Chip Outline and Bonding Pad Locations (Dimension in Micro-Meters)

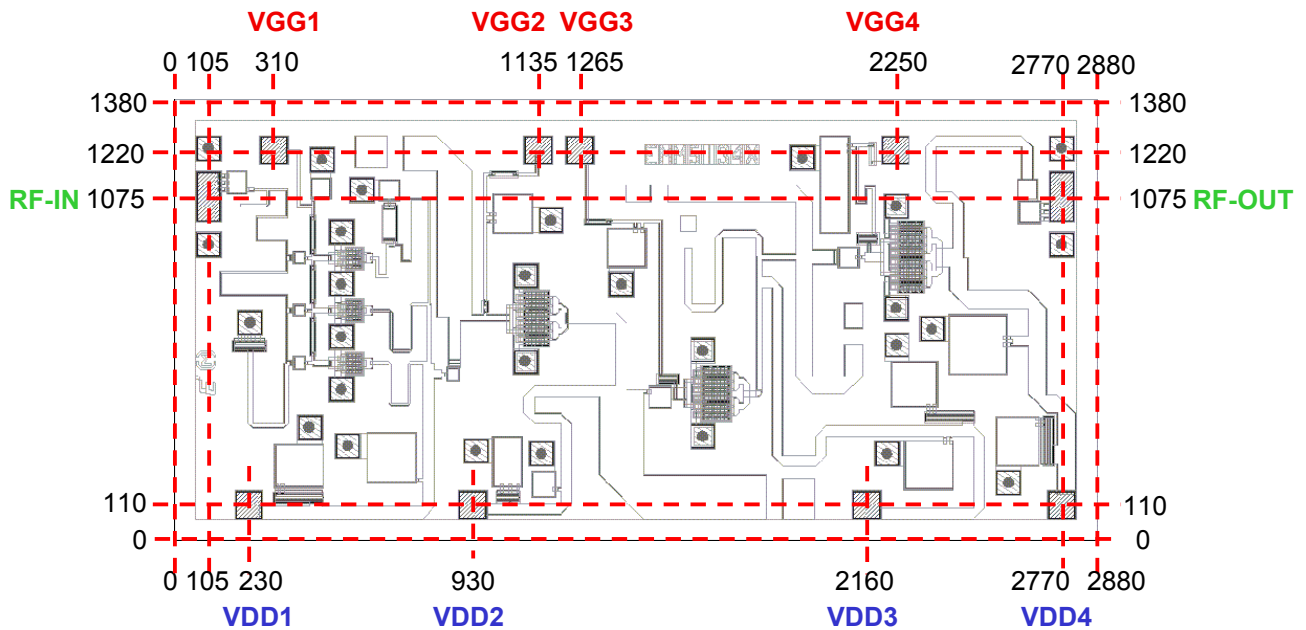

Chip Size : 2880±30µm x 1380±30µm

Chip Thickness : 60±20µm

Bonding Pad Size : 80µm x 80µm(VDD, VGG), 160µm x 80µm (RF)

# EMM5834X

Ku / K-band Power Amplifier MMIC

## ■ Assembly Diagrams

Recommended assembly

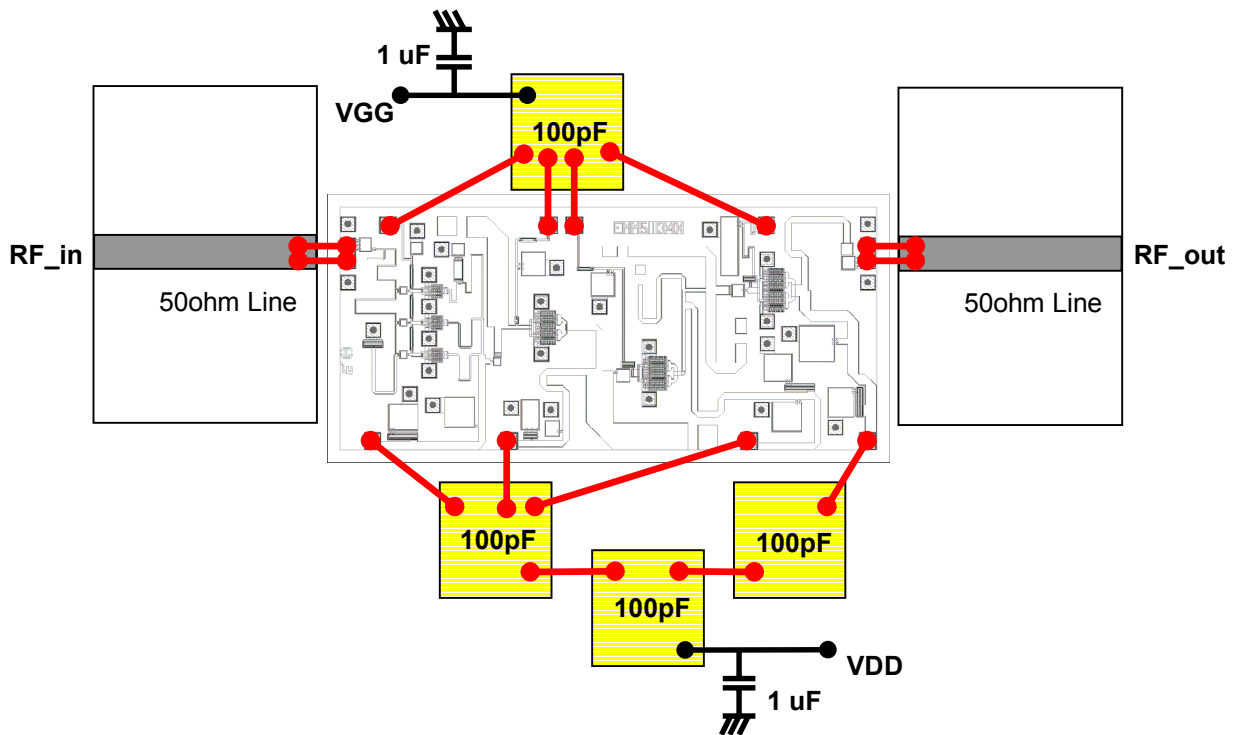

“Copper” is the recommended material for the package or carrier.

---

---

---

# EMM5834X

Ku / K-Band Power Amplifier MMIC

## ■ DIE ATTACH

- 1) The die-attach station must have accurate temperature control and an inert forming gas should be used.
- 2) Chips should be kept at room temperature except during die-attach.
- 3) Place package or carrier on the heated stage.
- 4) Lightly grasp the chip edges by the longer side using tweezers.

### Die attach conditions

Stage Temperature : 300 to 310 deg.C

Time : less than 15 seconds

AuSn Preform Volume : per next Figure

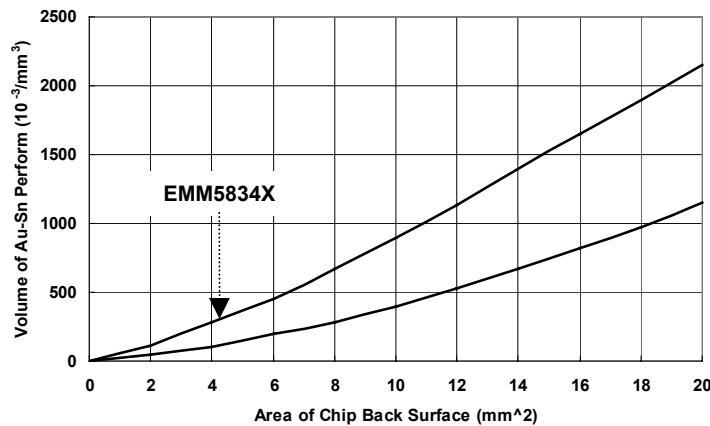

## ■ WIRE BONDING

The bonding equipment must be properly grounded. The following or equivalent equipment, tools, materials, and conditions are recommended.

### 1) Bonding Equipment and Bonding Tool.

Bonding Equipment : West Bond Model 7400 (Manual Bonder)

Bonding Tool : CCOD-1/16-S-437-60-F-2010-MP (Deweyl)

### 2) Bonding Wire

Material : Hard or Half hard gold

Diameter : 0.7 to 1.0 mil

### 3) Bonding Conditions

Method : Thermal Compression Bonding with Ultrasonic Power

Tool Force : 0.196 N  $\pm$  0.0196 N

Stage Temperature : 215 deg.C  $\pm$  5 deg.C

Tool Heater : None

Ultrasonic Power Transmitter : West Bond Model 1400

Duration : 150 mS/Bond

**Eudyna**

---

---

---

# EMM5834X

## Ku / K-band Power Amplifier MMIC

---

For further information please contact :

**Eudyna Devices USA Inc.**  
2355 Zanker Rd.  
San Jose, CA 95131-1138, U.S.A.  
TEL: +1 408 232-9500  
FAX: +1 408 428-9111

**Eudyna Devices Europe Ltd.**  
Network House  
Norreys Drive  
Maidenhead, Berkshire SL6 4FJ  
United Kingdom  
TEL: +44 (0) 1628 504800  
FAX: +44 (0) 1628 504888

**Eudyna Devices International Srl**  
Via Teglio 8/2 - 20158  
Milano, Italy  
TEL: +39-02-8738-1695

**Eudyna Devices Asia Pte. Ltd.**  
Hong Kong Branch  
Suite 1906B, Tower 6, China Hong Kong City  
33 Canton Road, Tsimshatsui, Kowloon  
Hong Kong  
TEL: +852-2377-0227  
FAX: +852-2377-3921

**Eudyna Devices Inc.**  
1000 Kamisukiahara, showa-cho  
Nakakomagun, Yamanashi  
409-3883, Japan  
(Kokubo Industrial Park)  
TEL +81-55-275-4411  
FAX +81-55-275-9461

**Sales Division**  
1, Kanai-cho, Sakae-ku  
Yokohama, 244-0845, Japan  
TEL +81-45-853-8156  
FAX +81-45-853-8170

### CAUTION

Eudyna Devices Inc. products contain **gallium arsenide (GaAs)** which can be hazardous to the human body and the environment. For safety, observe the following procedures:

- Do not put these products into the mouth.
- Do not alter the form of this product into a gas, powder, or liquid through burning, crushing, or chemical processing as these by-products are dangerous to the human body if inhaled, ingested, or swallowed.
- Observe government laws and company regulations when discarding this product. This product must be discarded in accordance with methods specified by applicable hazardous waste procedures.

Eudyna Devices Inc. reserves the right to change products and specifications without notice. The information does not convey any license under rights of Eudyna Devices Inc. or others.

© 2006 Eudyna Devices Inc.

---

