

Stacked Metallized PEN Film Chip Capacitor

Type: **ECWU(C)**

Stacked metallized PEN film as dielectric with simple mold-less construction

■Features

- Small in size
- For reflow soldering
- RoHS directive compliant

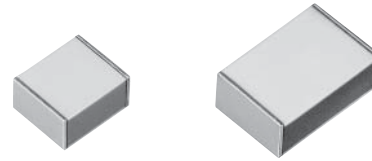

■Recommended Applications

- General purpose (Coupling, By-pass)

■Explanation of Part Numbers

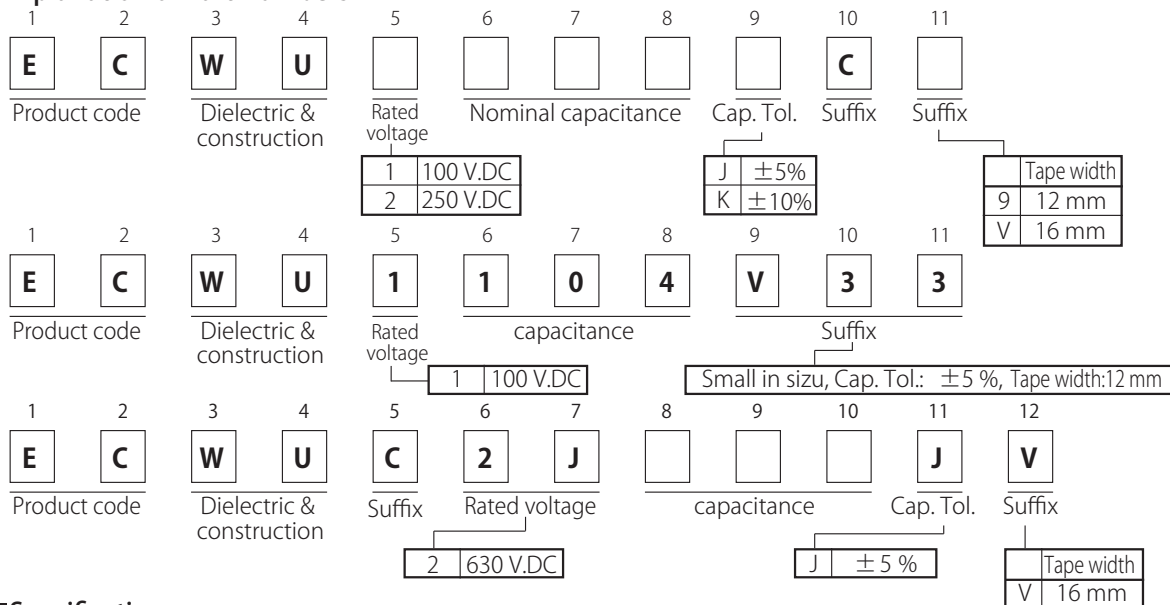

■Specifications

Category temp. range (Including temperature-rise on unit surface)	-55 °C to +125 °C	
Rated voltage	100 V.DC, 250 V.DC, 630 V.DC (Derating of rated voltage by 1.25 % / °C more than 85 °C)	
Capacitance range	100 V.DC	0.012 μF to 1.0 μF (E12)
	250 V.DC	0.0010 μF to 0.12 μF (E12)
	630 V.DC	0.022 μF, 0.027 μF, 0.033 μF
Capacitance tolerance	100 V.DC	± 5 % (J), ± 10 % (K) (C ≥ 0.18 μF : ± 10 % (K) only)
	250 V.DC	± 5 % (J), ± 10 % (K)
	630 V.DC	± 5 % (J)
Withstand voltage	Between terminals: Rated volt. (V.DC) x 150 % 60 s	
Dissipation factor (tan δ)	tan δ ≤ 1.0 % (20 °C, 1 kHz)	
Insulation resistance (IR)	C ≤ 0.33 μF	100 V.DC, 250 V.DC, 630 V.DC : IR ≥ 3000 MΩ · (20 °C, 100 V.DC, 60 s)
	C > 0.33 μF	100 V.DC : IR ≥ 1000 MΩ · μF (20 °C, 100 V.DC, 60 s)
Soldering conditions	100 V.DC	Reflow soldering : 240 °C max. and 60 s max. at more than 220 °C (Temp. at cap. surface) (Please consult us for Reflow 250 °C max. product.)
	250 V.DC	
	630 V.DC	Reflow soldering : 250 °C max. and 60 s to 150s. at more than 217 °C (Temp. at cap. surface)

* In case of applying voltage in alternating current (50 Hz or 60 Hz sine wave) to a capacitor with DC rated voltage, please refer to the page of "Permissible voltage (R.M.S) in alternating current corresponding to DC rated voltage".

* Please consult us for capacitance range between 0.15 μF and 1.0 μF. (250 V.DC)

Design, Specifications are subject to change without notice. Ask factory for technical specifications before purchase and/or use. Whenever a doubt about safety arises from this product, please inform us immediately for technical consultation without fail.

■ Construction

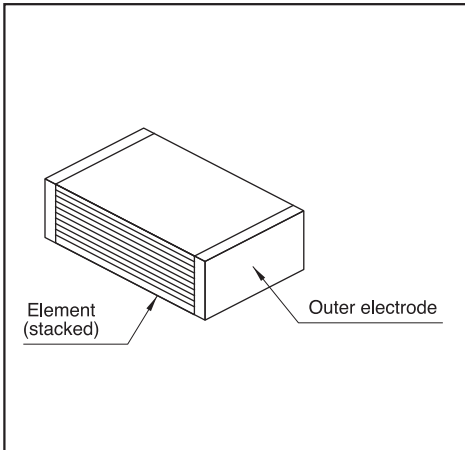

■ Dimensions in mm (not to scale)

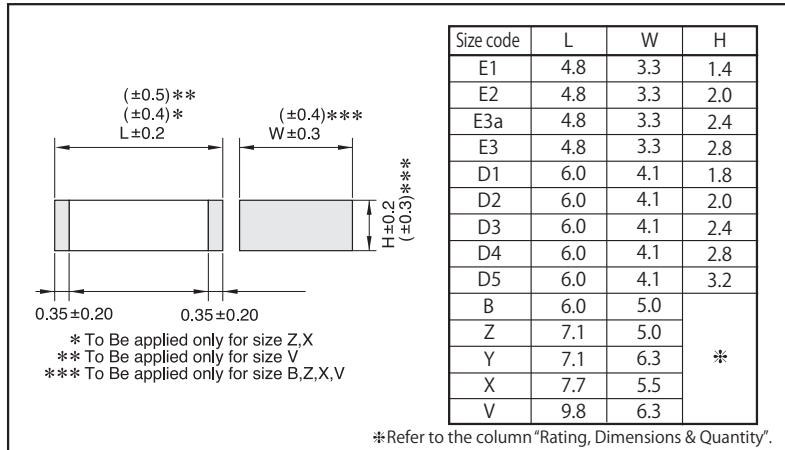

■ Taping Specification for Automatic Mounting
Refer to the page of taping specifications.

■ Rating, Dimensions & Quantity/Reel

● Capacitance tolerance : $\pm 5\%$ (J), $\pm 10\%$ (K)

Cap. (μ F)	Rated volt. 100 V.DC						Rated volt. 250 V.DC										
	Part No	Dimensions (mm)			Size code	Q'ty	Part No	Dimensions (mm)			Size code	Q'ty					
		L	W	H				L	W	H							
0.0010	Please use 100 V.DC rating ECWU(X)					ECWU2102 □C9	4.8	3.3	1.4	E1	3000						
0.0012						ECWU2122 □C9	4.8	3.3	1.4	E1							
0.0015						ECWU2155 □C9	4.8	3.3	1.4	E1							
0.0018						ECWU2182 □C9	4.8	3.3	1.4	E1							
0.0022						ECWU2222 □C9	4.8	3.3	1.4	E1							
0.0027						ECWU2272 □C9	4.8	3.3	1.4	E1							
0.0033						ECWU2332 □C9	4.8	3.3	1.4	E1							
0.0039						ECWU2392 □C9	4.8	3.3	1.4	E1							
0.0047						ECWU2472 □C9	4.8	3.3	1.4	E1							
0.0056						ECWU2562 □C9	4.8	3.3	1.4	E1							
0.0068						ECWU2682 □C9	4.8	3.3	1.4	E1							
0.0082						ECWU2822 □C9	4.8	3.3	1.4	E1							
0.010						ECWU2103 □C9	4.8	3.3	1.4	E1							
0.012						ECWU1123 □C9	4.8	3.3	1.4	E1		ECWU2123 □C9	4.8	3.3	1.4	E1	2000
0.015						ECWU1153 □C9	4.8	3.3	1.4	E1		ECWU2153 □C9	4.8	3.3	1.4	E1	
0.018	ECWU1183 □C9	4.8	3.3	1.4	E1	ECWU2183 □C9	4.8	3.3	2.0	E2							
0.022	ECWU1223 □C9	4.8	3.3	1.4	E1	ECWU2223 □C9	4.8	3.3	2.0	E2							
0.027	ECWU1273 □C9	4.8	3.3	1.4	E1	ECWU2273 □C9	4.8	3.3	2.4	E3a							
0.033	ECWU1333 □C9	4.8	3.3	1.4	E1	ECWU2333 □C9	4.8	3.3	2.8	E3							
0.039	ECWU1393 □C9	4.8	3.3	1.4	E1	ECWU2393 □C9	6.0	4.1	2.0	D2							
0.047	ECWU1473 □C9	4.8	3.3	2.0	E2	ECWU2473 □C9	6.0	4.1	2.4	D3							
0.056	ECWU1563 □C9	4.8	3.3	2.0	E2	ECWU2563 □C9	6.0	4.1	2.8	D4							
0.068	ECWU1683 □C9	4.8	3.3	2.4	E3a	ECWU2683 □C9	6.0	4.1	3.2	D5							
0.082	ECWU1823 □C9	4.8	3.3	2.8	E3	ECWU2823 □C9	6.0	5.0	3.2	B							
0.10	ECWU1104 □C9	6.0	4.1	1.8	D1	ECWU2104 □C9	6.0	5.0	3.8	B	1500						
	ECWU1104V33	4.8	3.3	2.8	E3												
0.12	ECWU1124 □C9	6.0	4.1	2.4	D3	ECWU2124 □C9	6.0	5.0	4.5	B	1500						
0.15	ECWU1154 □C9	6.0	4.1	2.8	D4												
0.18	ECWU1184KC9	7.1	5.0	2.0	Z												
0.22	ECWU1224KC9	7.1	5.0	2.4	Z												
0.27	ECWU1274KC9	7.1	5.0	2.9	Z												
0.33	ECWU1334KC9	7.1	5.0	3.5	Z												
0.39	ECWU1394KCV	7.7	5.5	3.4	X												
0.47	ECWU1474KCV	7.7	5.5	4.0	X												
0.56	ECWU1564KCV	9.8	6.3	3.0	V												
0.68	ECWU1684KCV	9.8	6.3	3.6	V												
0.82	ECWU1824KCV	9.8	6.3	4.3	V												
1.0	ECWU1105KCV	9.8	6.3	5.1	V												

↑ Cap. tol. code

Design, Specifications are subject to change without notice. Ask factory for technical specifications before purchase and/or use. Whenever a doubt about safety arises from this product, please inform us immediately for technical consultation without fail.

■ Rating, Dimensions & Quantity/Reel

● Capacitance tolerance : $\pm 5\%$ (J)

Cap. (μF)	Rated volt. 630 VDC					Q'ty
	Part No.	Dimensions (mm)			Size Code	
		L	W	H		
0.022	ECWUC2J223JV	7.1	6.3	3.6	Y	1000
0.027	ECWUC2J273JV	7.1	6.3	4.1	Y	
0.033	ECWUC2J333JV	7.1	6.3	5.1	Y	

■ Recommended for Land Dimensions (mm)

The diagram shows a top-down view of a capacitor with two rectangular electrodes. The distance between the inner edges of the electrodes is labeled 'A'. The distance between the outer edges is labeled 'B'. The height of the electrodes is labeled 'C'. The area between the electrodes is labeled 'Land'. One of the electrodes is labeled 'Electrode'.

Size code	Land dimensions for reflow soldering		
	A	B	C
E1,E2,E3a,E3	2.6	6.6	3.0
D1,D2,D3,D4,D5	3.8	7.8	3.8
B	3.8	7.8	4.6
Z	4.5	9.0	4.6
Y	4.5	9.0	5.7
X	5.1	9.7	5.0
V	7.2	11.9	5.7

ECWU (C) Type DC100V series (Stacked Metallized Film)

Electrical Characteristics < Typical Data >

Temperature Characteristics

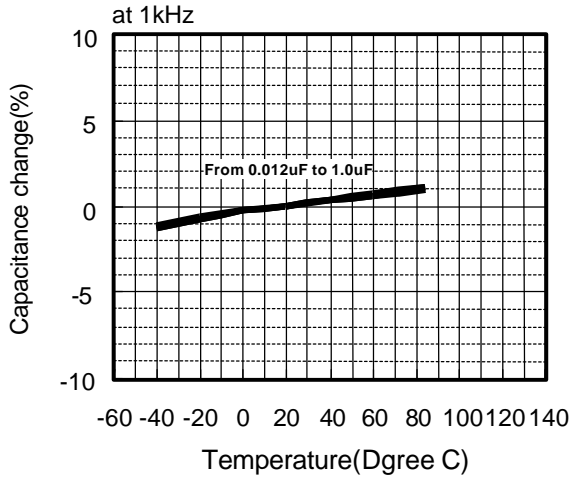

Frequency Characteristics

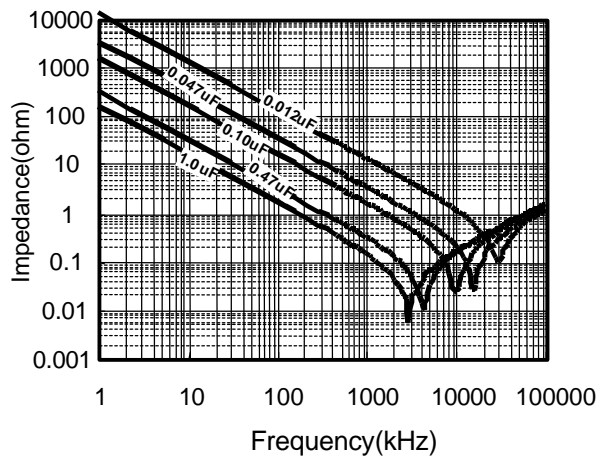
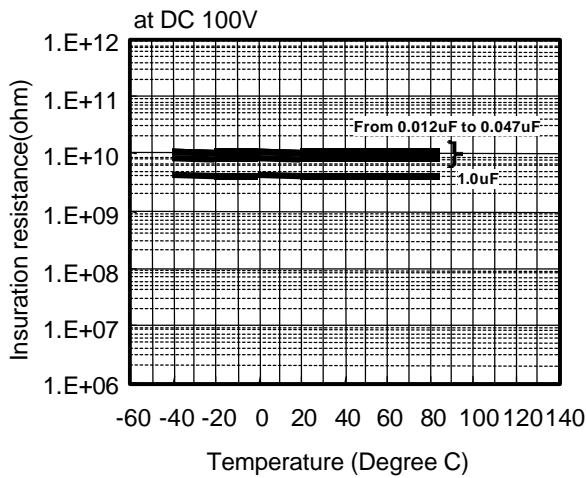
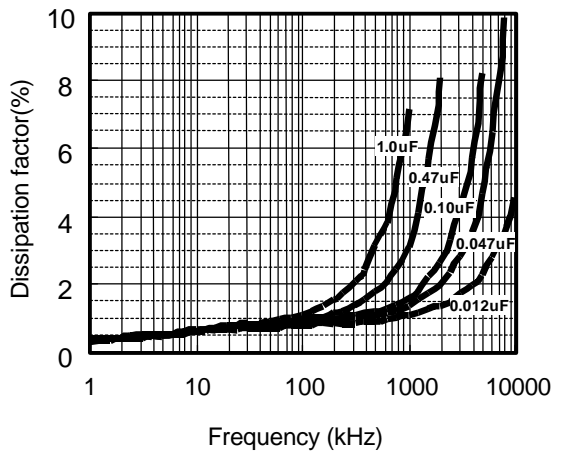
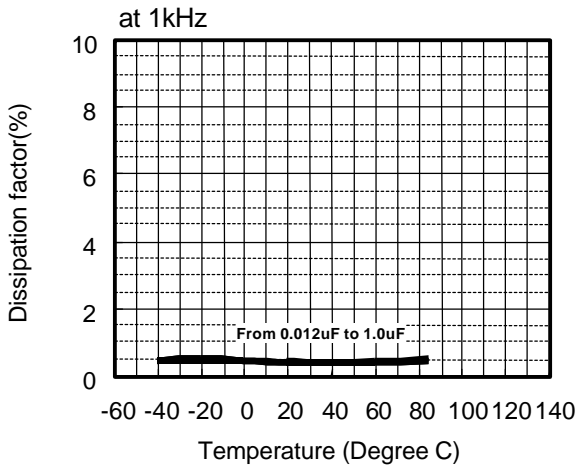
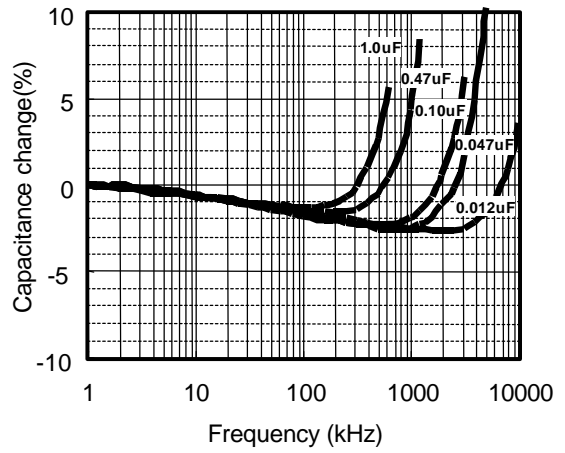

ECWU (C) Type DC100V series (Stacked Metallized Film)

Applicable Specifications

Permissible current

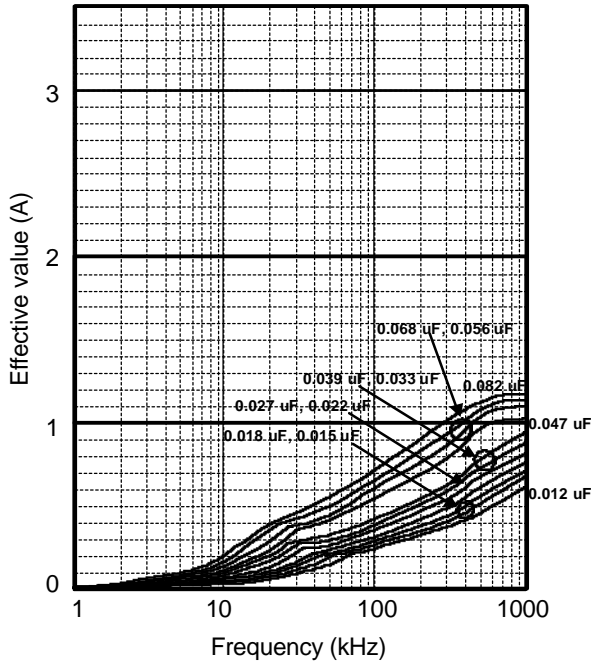

Permissible current

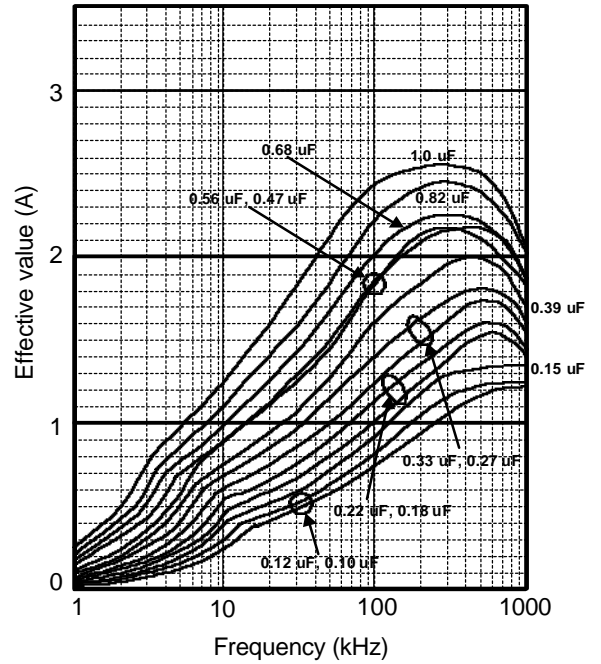

Permissible voltage (at sine wave)

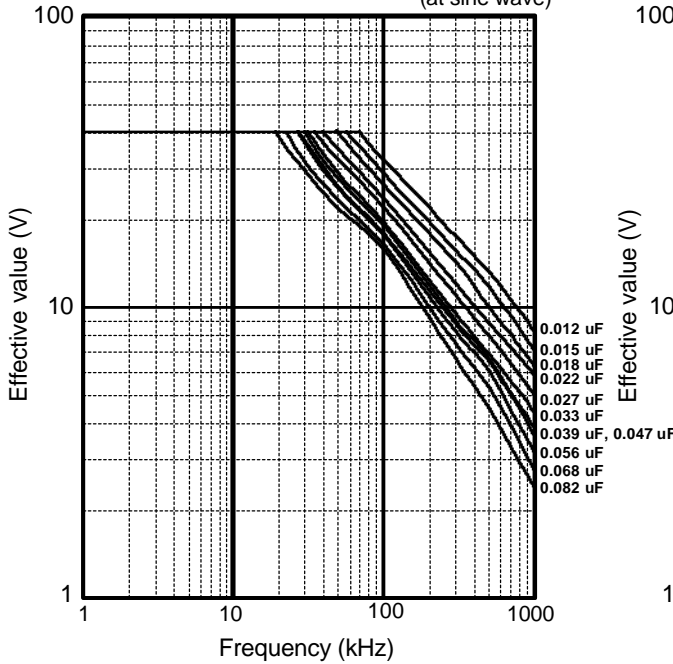

Permissible voltage (at sine wave)

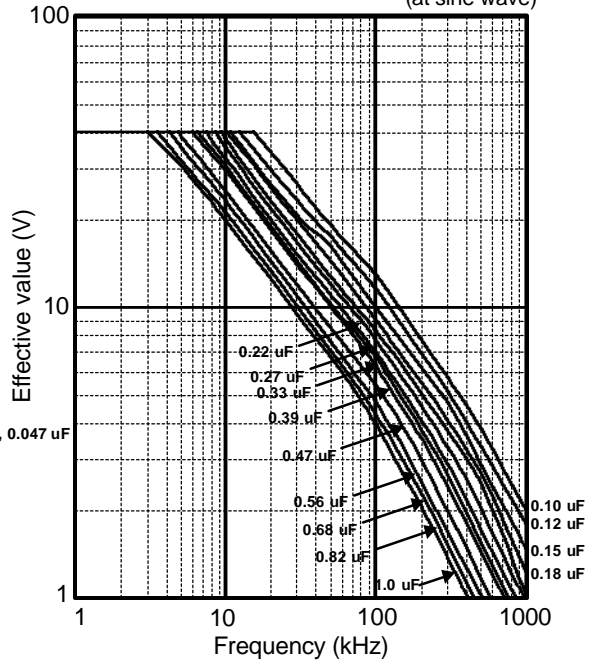

* Please consult Panasonic if your condition exceeds the above spec.

*Permissible voltage graph is the case of sine waveform. When you use this product, peak voltage must not exceed DC rated voltage.

*The current value (Aop) is calculated using "nominal capacitance." In fact, it changes by the tolerance of a capacitance value, capacitance change, etc.

ECWU (C) Type DC100V series (Stacked Metallized Film)

Applicable Specifications

Pulse Handling Capability (dv/dt)
(Max 10000cycles)

Rating Voltage	Capacitance Value(uF)	Code	dv/dt(V/us)	Current(I _{CP}) (A)
DC 100V	0.012	123	320	3.8
	0.015	123		4.8
	0.018	183		5.8
	0.022	223		7.0
	0.027	273		8.6
	0.033	333		10.6
	0.039	393		12.5
	0.047	473		15.0
	0.056	563		17.9
	0.68	683		21.8
	0.82	823		26.2

Pulse Handling Capability (dv/dt)
(Max 10000cycles)

Rating Voltage	Capacitance Value(uF)	Code	dv/dt(V/us)	Current(I _{CP}) (A)
DC 100V	0.10	104	210	21.0
	0.12	124		25.2
	0.15	154		31.5
	0.18	184	120	21.6
	0.22	224		26.4
	0.27	274		32.4
	0.33	334		39.6
	0.39	394	100	39.0
	0.47	474		47.0
	0.56	564	70	39.2
	0.68	684		47.6
	0.82	824		57.4
	1.0	105		70.0

Voltage Derating by Temperature

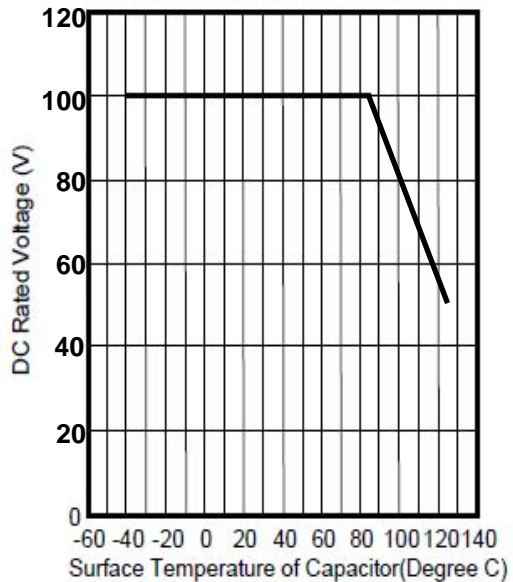

* Please consult Panasonic if your condition exceeds the above spec.

*Permissible voltage graph is the case of sine waveform. When you use this product, peak voltage must not exceed DC rated voltage.

*The current(I_{CP}) value is calculated using nominal capacitance.

ECWU (C) Type DC250V series (Stacked Metallized Film)

Electrical Characteristics < Typical Data >

Temperature Characteristics

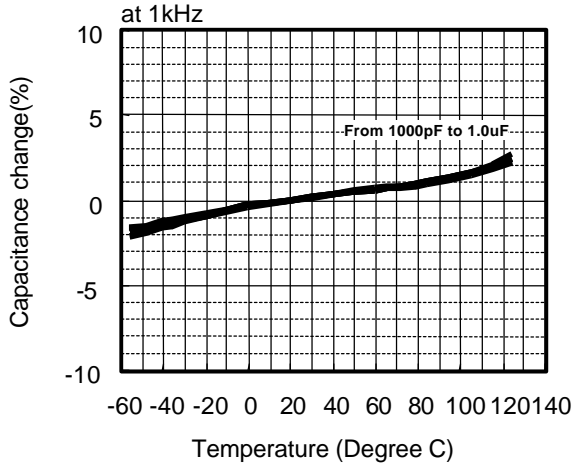

Frequency Characteristics

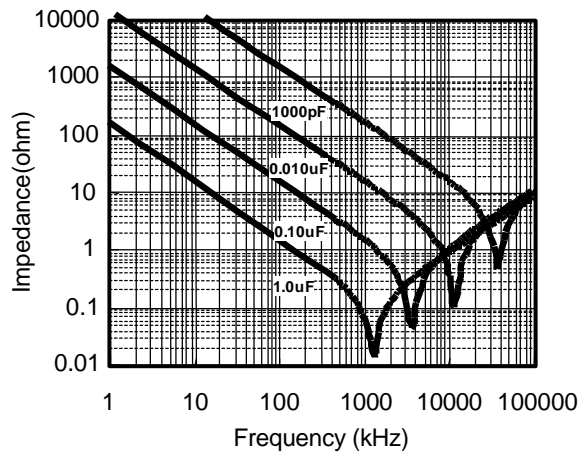
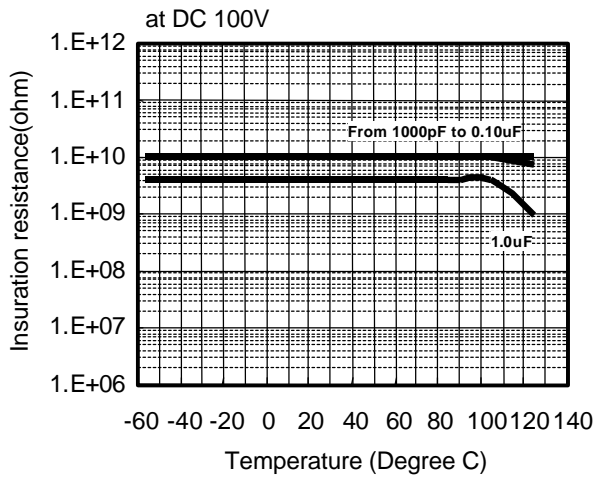
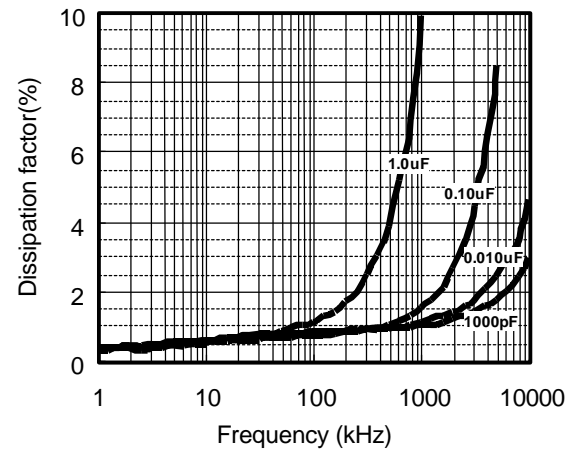
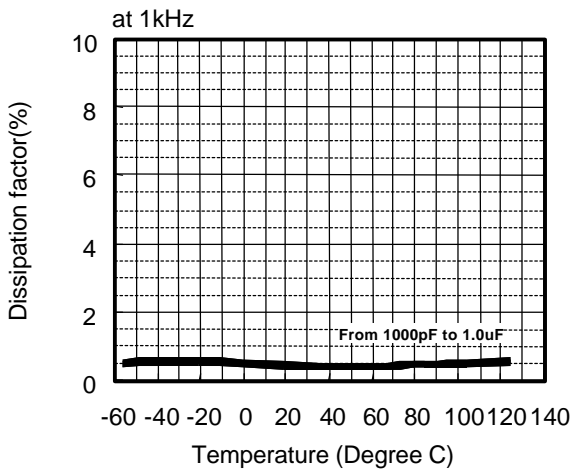
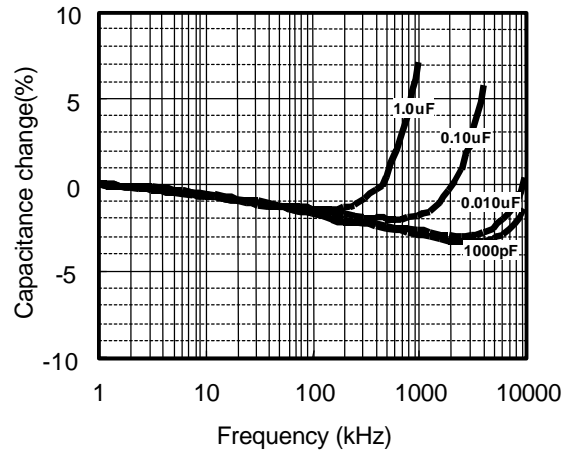

ECWU (C) Type DC250V series (Stacked Metallized Film)

Applicable Specifications

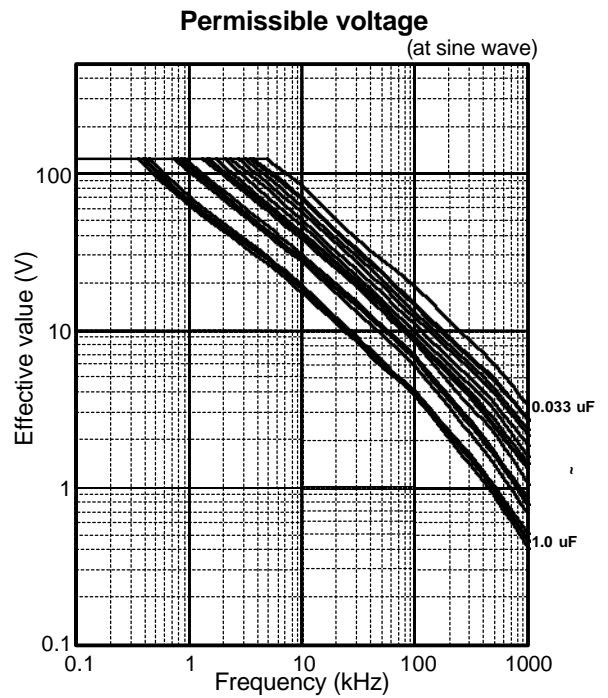
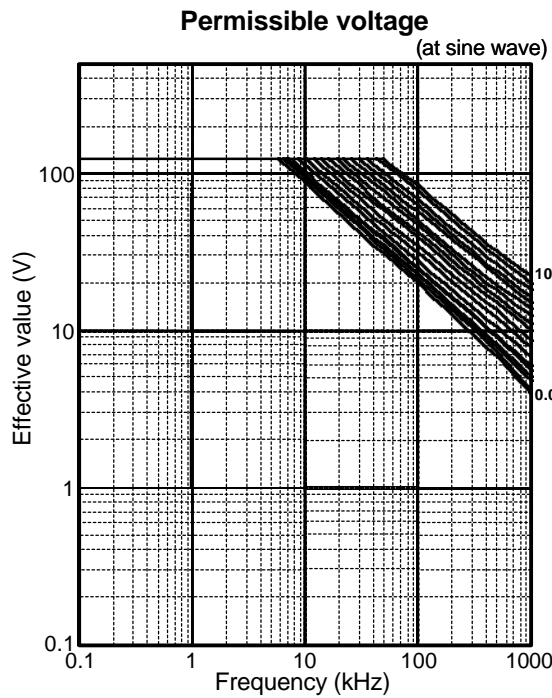
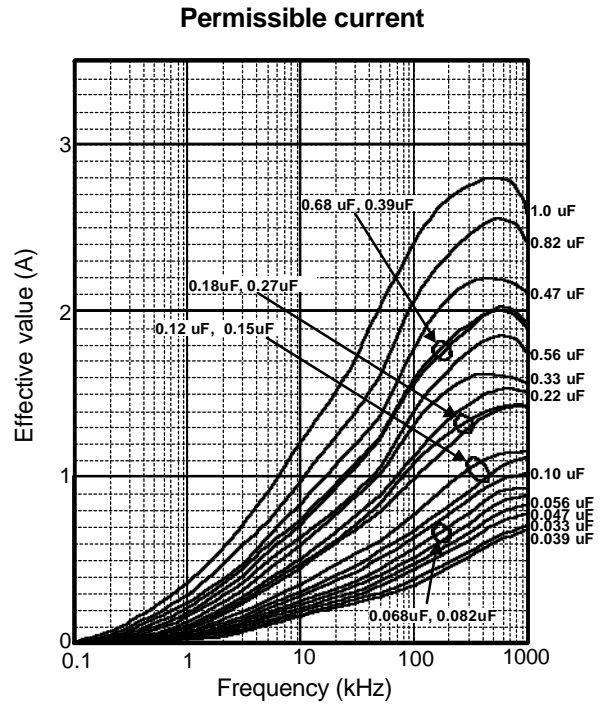
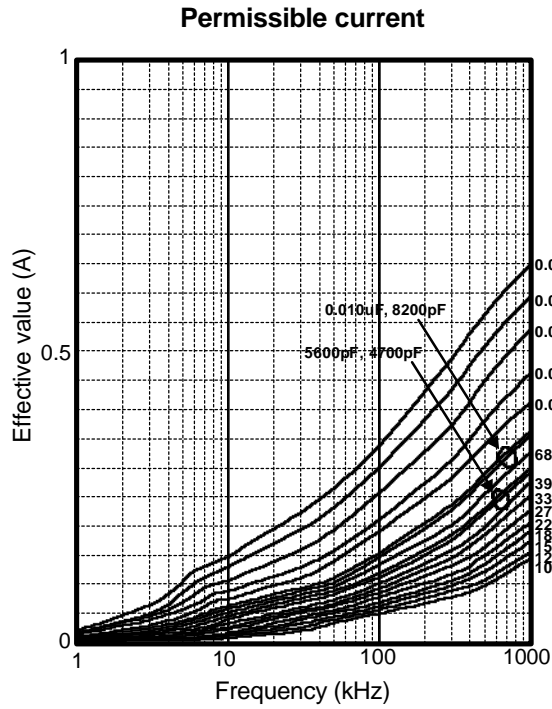

* Please consult Panasonic if your condition exceeds the above spec.

*Permissible voltage graph is the case of sine waveform. When you use this product, peak voltage must not exceed DC rated voltage.

*The current_(0.1P) value is calculated using nominal capacitance.



ECWU (C) Type DC250V series (Stacked Metallized Film)

Applicable Specifications

Pulse Handling Capability (dv/dt) (Max 10000cycles)

Rating Voltage	Capacitance Value(uF)	Code	dv/dt(V/us)	Current _(o,p) (A)
DC 250V	0.0010	102	615	0.62
	0.0012	122		0.74
	0.0015	152		0.92
	0.0018	182		1.11
	0.0022	222		1.35
	0.0027	272		1.66
	0.0033	332		2.03
	0.0039	392		2.40
	0.0047	472	360	1.69
	0.0056	562		2.02
	0.0068	682		2.45
	0.0082	822		2.95
	0.010	103		3.60
	0.012	123		4.32
	0.015	153		5.40
	0.018	183		6.48
	0.022	223		7.92
	0.027	273		9.72
	0.033	333		11.88

Rating Voltage	Capacitance Value(uF)	Code	dv/dt(V/us)	Current _(o,p) (A)
DC 250V	0.039	393	240	9.36
	0.047	473		11.28
	0.056	563		13.44
	0.068	683		16.32
	0.082	823		19.68
	0.10	104		24.00
	0.12	124		28.80
	0.15	154		190
	0.18	184	34.20	
	0.22	224	41.80	
	0.27	274	115	
	0.33	334		37.95
	0.39	394		44.85
	0.47	474		54.05
	0.56	564	65	36.40
	0.68	684		44.20
	0.82	824		53.30
	1.0	105		65.00

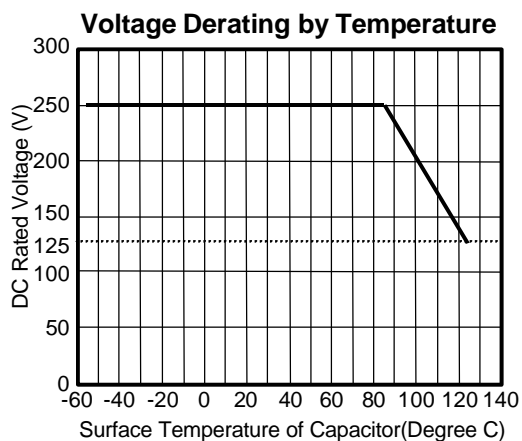

* Please consult Panasonic if your condition exceeds the above spec.

*Permissible voltage graph is the case of sine waveform. When you use this product, peak voltage must not exceed DC rated voltage.

*The current_(o,p) value is calculated using nominal capacitance.

Electrical Characteristics <Typical Data >

Temperature Characteristics

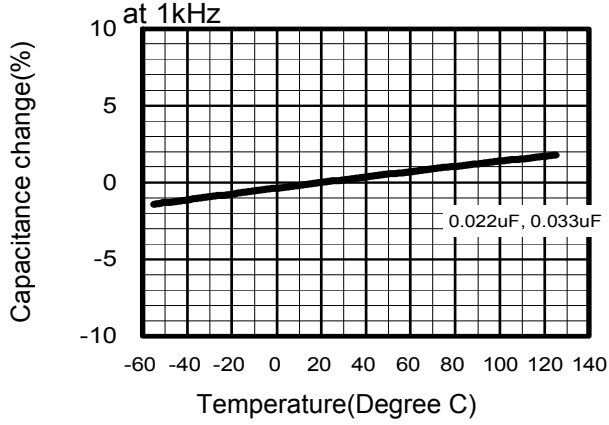

Frequency Characteristics

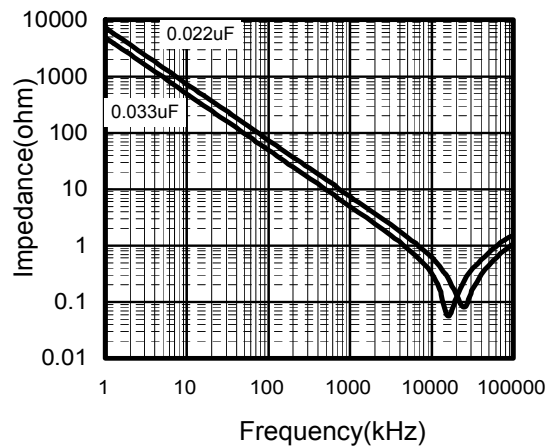
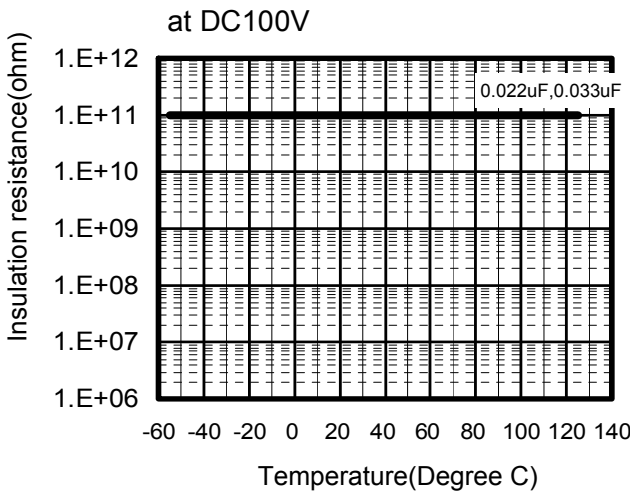
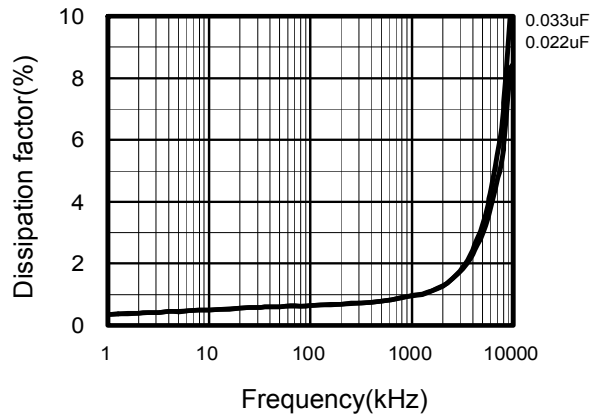
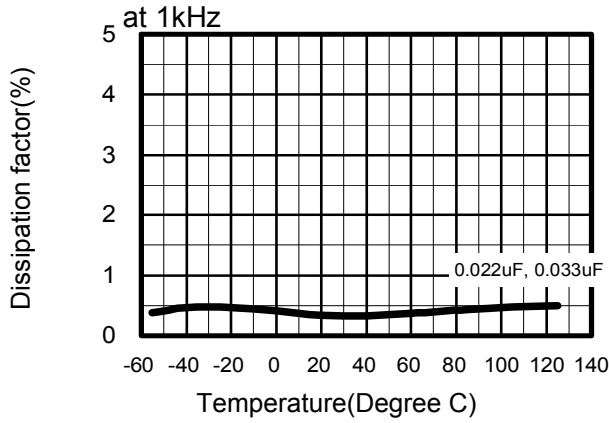
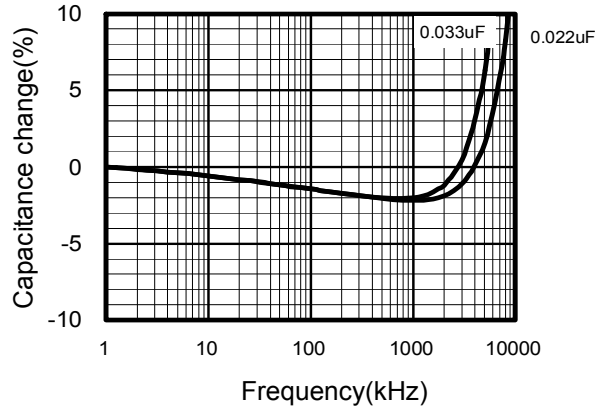

Applicable Specifications

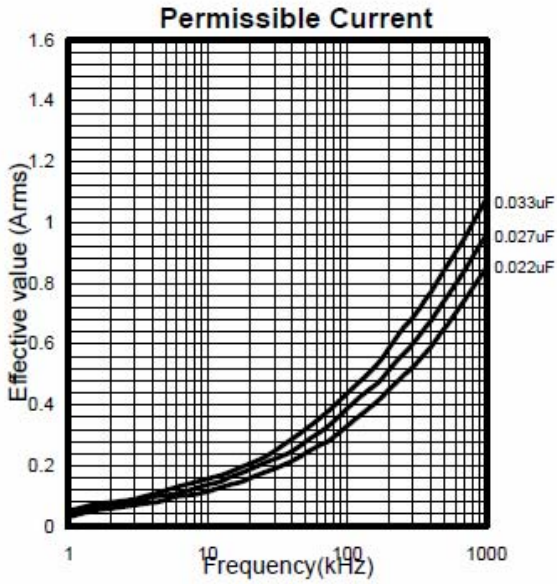

Voltage Derating by Temperature

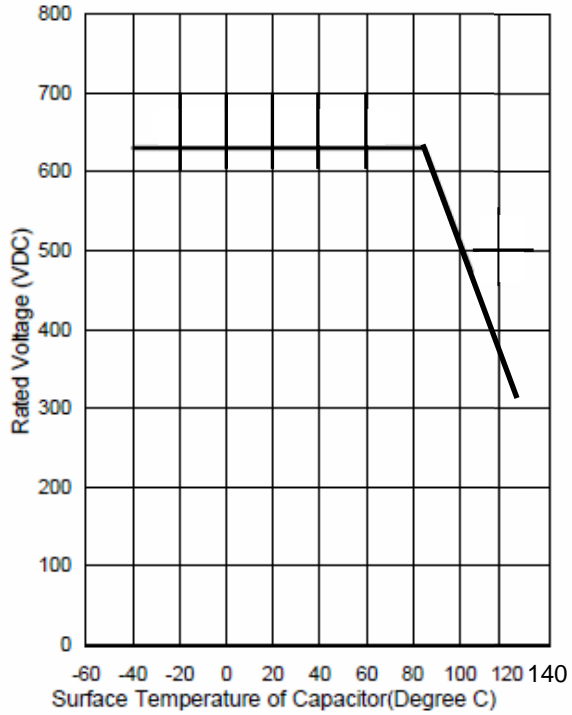

Pulse Handling Capability (dv/dt)
(Max 10000cycles)

Rating Voltage	Capacitance Value (μF)	Code	dV/dt (V/μs)	Current(A _{0-P})
DC 630V	0.022	223	250	5.5
	0.027	273	250	6.7
	0.033	333	250	8.2

*Please consult Panasonic if your condition exceeds the above

*Permissible voltage graph is the case of sine waveform. When you use this product, peak voltage must not exceed DC rated voltage.

*The current(0-P) value is calculated using nominal capacitance.

2.4.2 Cautions for use of soldering iron

- Be careful that the soldering irons do not directly touch the main body of the chip film capacitor. In particular, don't touch the side (cut section). If touched by the heated soldering iron, lowering of insulation resistance, shortcircuit or other characteristic deterioration may occur.
- Preheat the printed wiring board land sufficiently with the soldering iron, and then solder. Solder without directly touching the iron tip to the electrode of the capacitor.
- Don't reuse the products once removed by the soldering irons.
- Should not mount the chip film capacitors in the mass production by soldering iron. (The temperature control is difficult, and the characteristics may be deteriorated.)
- Should not resolder with heat directly from bottom side of P. W. Board. because capacitor will likely be damaged.

3. Washing the mounted boards

<Usable detergent and washing method>

(Usable detergent)

Classification	Detergent name	Maker
Alcohol derivative	IPA (isopropyl alcohol)	(Reagent for general industrial use)
Halogenated hydrocarbon	AK-225AES	Asahi Glass Co.

(Washing method)

Item	Condition	Temperature	Time
Immersion washing		50 °C	Within 5 minutes
Steam washing		50 °C	Within 5 minutes
Ultrasonic washing		50 °C	Within 5 minutes

<CFC substitute detergent>

As a result of regulation of CFC and chlorine derivative detergents, many substitute detergents come to be used, but the performance of the chip type capacitor may be reduced depending on the type of detergent or washing condition. Check sufficiently beforehand. Consult us in advance if planning to use CFC substitute detergent.

<Drying after washing>

Dry after washing so that the detergent is not left over. If drying is insufficient, the detergent is left over on the element surface, and the insulation resistance is measured to be lowered. Dry enough so as not to leave detergent.

3.1. Washing of chip type

- Since the chip type capacitor does not have a coating, components of flux or detergent left over on the element at the time of washing may be activated and invade into the inside of the capacitor, and adverse effects may be caused. Observe the following cautions.
- In the case of washing, use flux and cream solder with halogen content of 0.1wt.% or less when mounting.
- In the case of ultrasonic washing, note that peeling of protective film, electrode separation due to resonance, or characteristic deterioration may occur depending on the detergent used or ultrasonic output. Check carefully beforehand.
- When using a CFC substitute detergent, with the washing method of spraying detergent (rinsing water) to the substrate at high pressure, the protective film on the element surface may be peeled off due to the water pressure. Check carefully beforehand.

3.2. Washing of leaded type

The film capacitor varies significantly in the effect of washing depending on the structure and material, and generally it is less affected by CFC or alcohol derivative washing solvent, and is likely to be affected by highly polar solvent.

The lead type film capacitor is coated with an epoxy resin excellent in chemical resistance, and is hardly affected by detergent, but it is recommended to be washed for short duration.

Applicability of detergents in film capacitors is listed for reference.

