

Temperature Controllers

E5CSV

CSM_E5CSV_DS_E_6_1

Easy Setting Using DIP Switch and Simple Functions in DIN 48 × 48 mm-size Temperature Controllers

- Easy setting using DIP switch.
- Models with two alarms added to Series, ideal for temperature alarm applications.
- Universal-input (thermocouple/platinum resistance thermometer) models also available.
- Clearly visible digital display with character height of 13.5 mm.
- Models available with black in addition to white cases.
- RoHS compliant.



⚠ Refer to *Safety Precautions for All Temperature Controllers*.

Refer to *E5CS/E5CSV Operation* for operating procedures.

Model Number Structure

■ Model Number Legend

Models with Terminal Blocks

E5CSV-□□□□-□
1 2 3 4 5

1. Control Outputs

- R: Relay
- Q: Voltage for driving SSR

2. Alarm Outputs

- Blank: No alarm
- 1: 1 alarm
- 2: 2 alarms

3. Input

- KJ: Thermocouple
- P: Platinum resistance thermometer
- T: Thermocouple/platinum resistance thermometer (universal-input)

4. Power Supply Voltage

- Blank: 100 to 240 VAC
- D: 24 VAC/VDC

5. Case Color

- Blank: Black
- W: Light gray

Note: A functional explanation is provided here for illustration, but models are not necessarily available for all possible combinations. Refer to *Ordering Information* when ordering.

Examples

- Relay control output, without alarm, thermocouple input, light gray case: E5CSV-RKJ-W
- Relay control output, one alarm output, platinum resistance thermometer input, black case: E5CSV-R1P-W

Ordering Information

■ List of Models

**Case Color: Light Gray, Thermocouple or Platinum Resistance Thermometer,
Power Supply Voltage: 100 to 240 VAC**

Size	Type	Control modes	Alarms	Outputs	Model with thermocouple	Model with platinum resistance thermometer
E5CSV 48 × 48mm	Terminal block	ON/OFF or PID	1	Relay	E5CSV-R1KJ-W	E5CSV-R1P-W
				Voltage (for driving SSR)	E5CSV-Q1KJ-W	E5CSV-Q1P-W

Case Color: Light Gray, Thermocouple, Power Supply Voltage: 24 VAC/VDC

Size	Type	Control modes	Alarms	Outputs	Model with thermocouple
E5CSV 48 × 48mm	Terminal block	ON/OFF or PID	1	Relay	E5CSV-R1KJD-W

Case Color: Light Gray, Universal-input, Power Supply Voltage: 100 to 240 VAC

Size	Type	Control modes	Alarms	Outputs	Model with universal-input (thermocouple or platinum resistance thermometer)
E5CSV 48 × 48mm	Terminal block	ON/OFF or PID	0	Relay	E5CSV-RT
				Voltage (for driving SSR)	E5CSV-QT
			1	Relay	E5CSV-R1T
				Voltage (for driving SSR)	E5CSV-Q1T
			2 (See note.)	Relay	E5CSV-R2T
				Voltage (for driving SSR)	E5CSV-Q2T

Note: There is no alarm output 2 mode switch. The default setting for alarm output 2 is for the upper limit alarm mode. To change the setting, change the alarm type for alarm output 2 in initial setting level 5. For details, refer to the "E5CSV/E5CS-U Digital Temperature Controller User's Manual" (Cat. No. H140-E1-01).

Case Color: Black, Universal-input, Power Supply Voltage: 24 VAC/VDC

Size	Type	Control modes	Alarms	Outputs	Model with universal-input (thermocouple or platinum resistance thermometer)
E5CSV 48 × 48mm	Terminal block	ON/OFF or PID	0	Relay	E5CSV-RTD
				Voltage (for driving SSR)	E5CSV-QTD
			1	Relay	E5CSV-R1TD
				Voltage (for driving SSR)	E5CSV-Q1TD
			2 (See note.)	Relay	E5CSV-R2TD
				Voltage (for driving SSR)	E5CSV-Q2TD

Note: There is no alarm output 2 mode switch. The default setting for alarm output 2 is for the upper limit alarm mode. To change the setting, change the alarm type for alarm output 2 in initial setting level 5. For details, refer to the "E5CSV/E5CS-U Digital Temperature Controller User's Manual" (Cat. No. H140-E1-01).

■ Accessories (Order Separately)

Protective Cover

Type	Model
Hard Protective Cover	Y92A-48B

Terminal Cover

Model
E53-COV10

Rubber Packing

Model
Y92S-29

Note: The Rubber Packing is provided with the Digital Controller.

Specifications

■ Ratings

Supply voltage		100 to 240 VAC, 50/60 Hz 24 VAC, 50/60 Hz; 24 VDC
Operating voltage range		85% to 110% of rated supply voltage
Power consumption		100 to 240 VAC: 5 VA 24 VAC: 3 VA, 24 VDC: 2 W
Sensor input		Thermocouple input type: K, J, L Platinum resistance thermometer input type: Pt100, JPt100 Universal-input (thermocouple/platinum resistance thermometer) type: K, J, L, T, U, N, R, Pt100, JPt100
Control output	Relay output	SPST-NO, 250 VAC, 3A (resistive load)
	Voltage output (for driving the SSR)	12 VDC, 21 mA (with short-circuit protection circuit)
Control method		ON/OFF or 2-PID (with auto-tuning)
Alarm output		SPST-NO, 250 VAC, 1A (resistive load)
Setting method		Digital setting using front panel keys
Indication method		7-segment digital display (character height: 13.5 mm) and deviation indicators
Other functions		<ul style="list-style-type: none"> • Setting change prohibit (key protection) • Input shift • Temperature unit change (°C/°F) • Direct/reverse operation • Temperature range, Sensor switching (K/J/L, Pt100/JPt100) • Switching is performed between a thermocouple and platinum resistance thermometer for universal-input models. • Control period switching • 8-mode alarm output • Sensor error detection
Ambient operating temperature		-10 to 55°C (with no condensation or icing); with 3-year guarantee: -10 to 50°C
Ambient operating humidity		25% to 85%
Storage temperature		-25 to 65°C (with no condensation or icing)

- Note:** 1. Do not use an inverter output as the power supply. (Refer to *Safety Precautions for All Temperature Controllers*.)
2. Models for 24 VAC/DC can also be manufactured.

■ Characteristics

Setting accuracy	Thermocouple (See note 1.): (±0.5% of indication value or ±1°C, whichever is greater) ±1 digit max. Platinum resistance thermometer (See note 2.): (±0.5% of indication value or ±1°C, whichever is greater) ±1 digit max.	
Indication accuracy (ambient temperature of 23°C)		
Influence of temperature	R thermocouple inputs: (±1% of PV or ±10°C, whichever is greater) ±1 digit max. Other thermocouple inputs: (±1% of PV or ±4°C, whichever is greater) ±1 digit max.	
Influence of voltage	Platinum resistance thermometer inputs: (±1% of PV or ±2°C, whichever is greater) ±1 digit max.	
Hysteresis (for ON/OFF control)	0.2% FS (0.1% FS for universal-input (thermocouple/platinum resistance thermometer) models)	
Proportional band (P)	1 to 999°C (automatic adjustment using auto-tuning/self-tuning)	
Integral time (I)	1 to 1,999 s (automatic adjustment using auto-tuning/self-tuning)	
Derivative time (D)	1 to 1,999 s (automatic adjustment using auto-tuning/self-tuning)	
Alarm output range	Absolute-value alarm: Same as the control range Other: 0 to input setting range full scale (°C or °F) Alarm hysteresis: 0.2°C or °F (fixed)	
Control period	2/20 s	
Sampling period	500 ms	
Insulation resistance	20 MΩ min. (at 500 VDC)	
Dielectric strength	2,000 VAC, 50/60 Hz for 1 min between current-carrying terminals of different polarity	
Vibration resistance	Malfunction	10 to 55 Hz, 20 m/s ² for 10 min each in X, Y, and Z directions
	Destruction	10 to 55 Hz, 0.75-mm single amplitude for 2 hr each in X, Y, and Z directions
Shock resistance	Malfunction	100 m/s ² min., 3 times each in 6 directions
	Destruction	300 m/s ² min., 3 times each in 6 directions
Life expectancy	Electrical	100,000 operations min. (relay output models)
Weight	Approx. 120 g (Controller only)	
Degree of protection	Front panel: Equivalent to IP66; Rear case: IP20; Terminals: IP00	
Memory protection	EEPROM (non-volatile memory) (number of writes: 1,000,000)	
EMC	EMI Radiated: EN 55011 Group 1 Class A EMI Conducted: EN 55011 Group 1 Class A ESD Immunity: EN 61000-4-2: 4 kV contact discharge (level 2) 8 kV air discharge (level 3) Radiated Electromagnetic Field Immunity: EN 61000-4-3: 10 V/m (80-1000 MHz, 1.4-2.0 GHz amplitude modulated) (level 3) 10 V/m (900 MHz pulse modulated) Conducted Disturbance Immunity: EN 61000-4-6: 3 V (0.15 to 80 MHz) (level 2) Noise Immunity (First Transient Burst Noise): EN 61000-4-4 Burst Immunity: EN 61000-4-6: 3 V (0.15 to 80 MHz) (level 3) Surge Immunity: EN 61000-4-5: Power line: Normal mode 1 kV; Common mode 2 kV Output line (relay output): Normal mode 1 kV; Common mode 2 kV Voltage Dip/Interrupting Immunity: EN 61000-4-11 0.5 cycle, 100% (rated voltage)	
Approved standards	UL 61010-1 (listing) CSA C22.2 No.1010-1	
Conformed standards	EN 61326, EN 61010-1, IEC 61010-1 VDE 0106 Part 100 (finger protection), when the terminal cover is mounted.	

- Note:** 1. The following exceptions apply to thermocouples.
• U, L: ±2°C ±1 digit max.
• R: ±3°C ±1 digit max. at 200°C or less
2. The following exceptions apply to platinum resistance thermometers.
Input set values 0, 1, 2, 3 for E5CSV: 0.5% FS ±1 digit max.

Temperature Range

Thermocouple Input Models

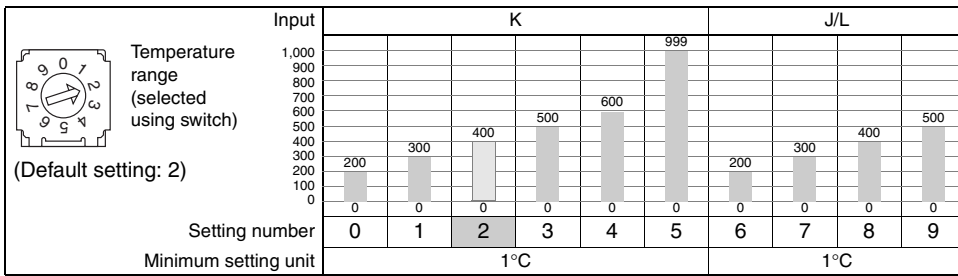

The shaded value indicates the default setting status.

Platinum Resistance Thermometer Input Models

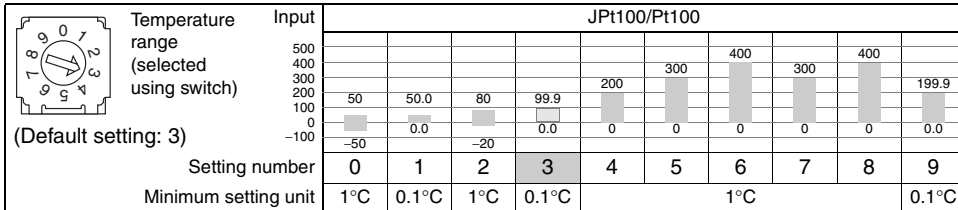

The shaded value indicates the default setting status.

Universal-input (Thermocouple/Platinum Resistance Thermometer) Models

Using Thermocouple Sensors, Control Mode Switch 5: OFF

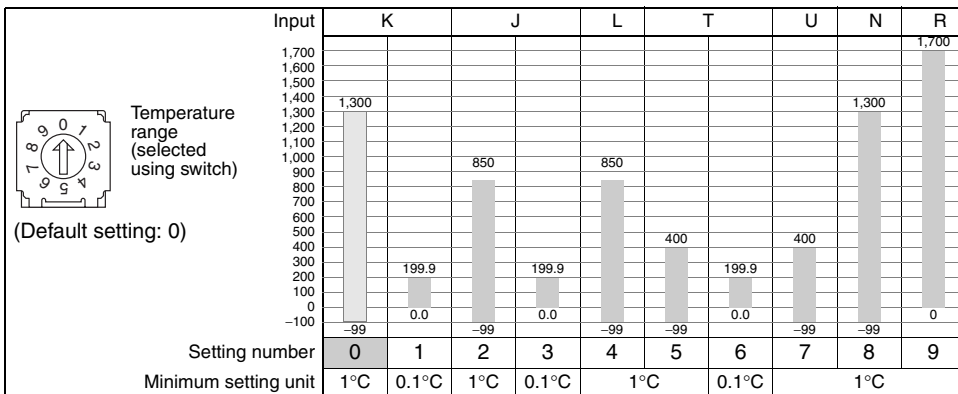

The shaded value indicates the default setting status.

Using Platinum Resistance Thermometers, Control Mode Switch 5: ON

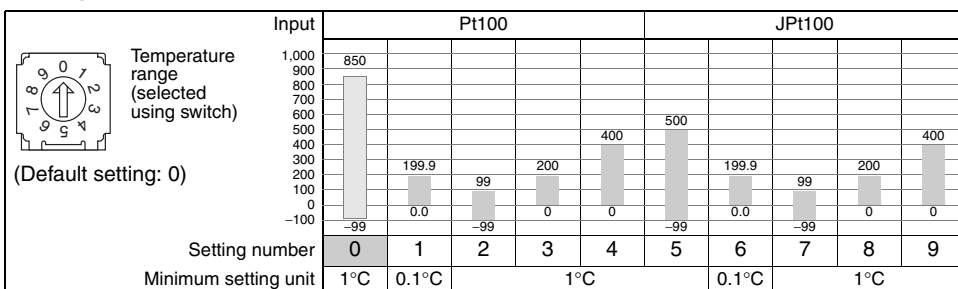

The shaded value indicates the default setting status.

External Connection Diagram

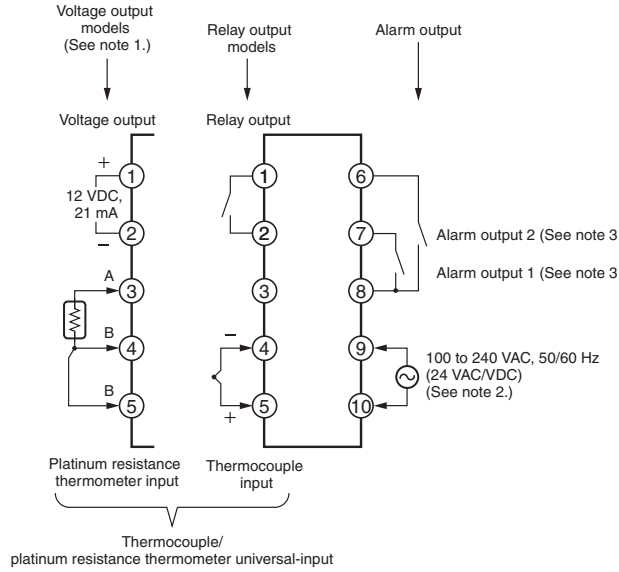

- Note:**
1. The voltage output (12 VDC, 21 mA) is not electrically isolated from the internal circuits. When using a grounding thermocouple, do not connect output terminals 1 or 2 to ground. Otherwise, unwanted current paths will cause measurement errors.
 2. Models with 100 to 240 VAC and 24 VAC/VDC are separate. Models using 24 VDC have no polarity.
 3. The number of alarm outputs depends on the model.

Nomenclature

E5CSV Models with Terminal Blocks



Dimensions

Note: All units are in millimeters unless otherwise indicated.

Controller

E5CSV

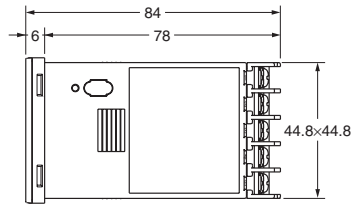
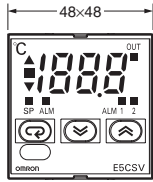
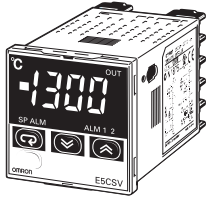

Panel Cutout Dimensions

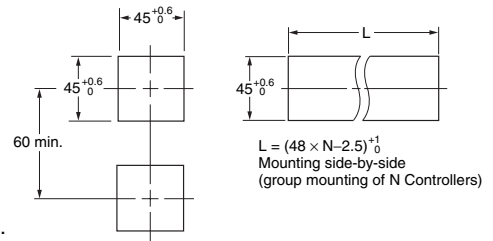

Note: Terminals cannot be removed.

E5CSV + Adapter for Flush Mounting (Provided)

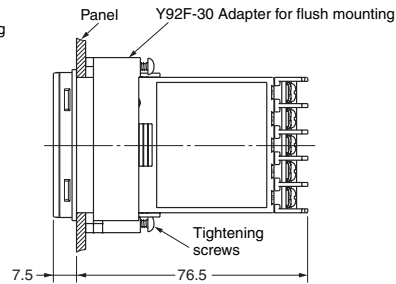
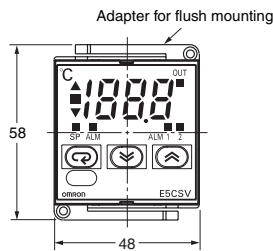
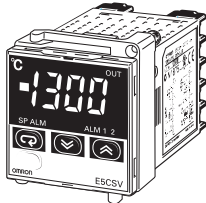
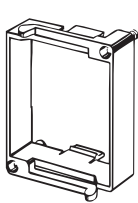

- Note: 1. The recommended panel thickness is 1 to 4 mm.
- 2. Group mounting is possible in one direction only.

Accessories (Order Separately)

Hard Protective Cover

The Y92A-48B Protective Cover (hard type) is available for the following applications.

- To protect the set from dust and dirt.
- To prevent the panel from being accidentally touched causing displacement of set values.
- To provide effective protection against water droplets.

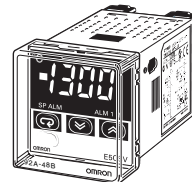

Terminal Cover

E53-COV10

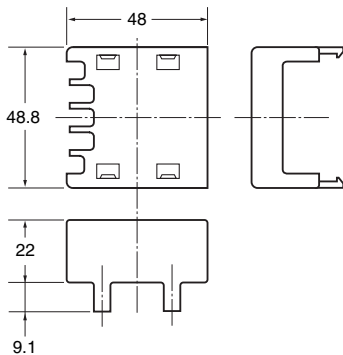
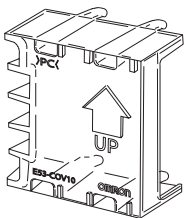

Rubber Packing

Y92S-29 (for DIN48 x 48)

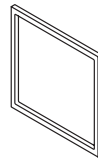

Order the Rubber Packing separately if it becomes lost or damaged. The Rubber Packing can be used to achieve an IP66 degree of protection for models with terminal blocks.

(Deterioration, shrinking, or hardening of the rubber packing may occur depending on the operating environment. Therefore, periodic replacement is recommended to ensure the level of waterproofing specified in NEMA4. The time for periodic replacement depends on the operating environment. Be sure to confirm this point at your site. Consider one year a rough standard. OMRON shall not be liable for the level of water resistance if the customer does not perform periodic replacement.)

The Rubber Packing does not need to be attached if a waterproof structure is not required.

Safety Precautions

Refer to *Safety Precautions for All Temperature Controllers*.
Refer to *E5CS/E5CSV Operation* for operating procedures.

ALL DIMENSIONS SHOWN ARE IN MILLIMETERS.

To convert millimeters into inches, multiply by 0.03937. To convert grams into ounces, multiply by 0.03527.

In the interest of product improvement, specifications are subject to change without notice.

Read and Understand This Catalog

Please read and understand this catalog before purchasing the products. Please consult your OMRON representative if you have any questions or comments.

Warranty and Limitations of Liability

WARRANTY

OMRON's exclusive warranty is that the products are free from defects in materials and workmanship for a period of one year (or other period if specified) from date of sale by OMRON.

OMRON MAKES NO WARRANTY OR REPRESENTATION, EXPRESS OR IMPLIED, REGARDING NON-INFRINGEMENT, MERCHANTABILITY, OR FITNESS FOR PARTICULAR PURPOSE OF THE PRODUCTS. ANY BUYER OR USER ACKNOWLEDGES THAT THE BUYER OR USER ALONE HAS DETERMINED THAT THE PRODUCTS WILL SUITABLY MEET THE REQUIREMENTS OF THEIR INTENDED USE. OMRON DISCLAIMS ALL OTHER WARRANTIES, EXPRESS OR IMPLIED.

LIMITATIONS OF LIABILITY

OMRON SHALL NOT BE RESPONSIBLE FOR SPECIAL, INDIRECT, OR CONSEQUENTIAL DAMAGES, LOSS OF PROFITS OR COMMERCIAL LOSS IN ANY WAY CONNECTED WITH THE PRODUCTS, WHETHER SUCH CLAIM IS BASED ON CONTRACT, WARRANTY, NEGLIGENCE, OR STRICT LIABILITY.

In no event shall the responsibility of OMRON for any act exceed the individual price of the product on which liability is asserted.

IN NO EVENT SHALL OMRON BE RESPONSIBLE FOR WARRANTY, REPAIR, OR OTHER CLAIMS REGARDING THE PRODUCTS UNLESS OMRON'S ANALYSIS CONFIRMS THAT THE PRODUCTS WERE PROPERLY HANDLED, STORED, INSTALLED, AND MAINTAINED AND NOT SUBJECT TO CONTAMINATION, ABUSE, MISUSE, OR INAPPROPRIATE MODIFICATION OR REPAIR.

Application Considerations

SUITABILITY FOR USE

OMRON shall not be responsible for conformity with any standards, codes, or regulations that apply to the combination of products in the customer's application or use of the products.

At the customer's request, OMRON will provide applicable third party certification documents identifying ratings and limitations of use that apply to the products. This information by itself is not sufficient for a complete determination of the suitability of the products in combination with the end product, machine, system, or other application or use.

The following are some examples of applications for which particular attention must be given. This is not intended to be an exhaustive list of all possible uses of the products, nor is it intended to imply that the uses listed may be suitable for the products:

- Outdoor use, uses involving potential chemical contamination or electrical interference, or conditions or uses not described in this catalog.
- Nuclear energy control systems, combustion systems, railroad systems, aviation systems, medical equipment, amusement machines, vehicles, safety equipment, and installations subject to separate industry or government regulations.
- Systems, machines, and equipment that could present a risk to life or property.

Please know and observe all prohibitions of use applicable to the products.

NEVER USE THE PRODUCTS FOR AN APPLICATION INVOLVING SERIOUS RISK TO LIFE OR PROPERTY WITHOUT ENSURING THAT THE SYSTEM AS A WHOLE HAS BEEN DESIGNED TO ADDRESS THE RISKS, AND THAT THE OMRON PRODUCTS ARE PROPERLY RATED AND INSTALLED FOR THE INTENDED USE WITHIN THE OVERALL EQUIPMENT OR SYSTEM.

PROGRAMMABLE PRODUCTS

OMRON shall not be responsible for the user's programming of a programmable product, or any consequence thereof.

Disclaimers

CHANGE IN SPECIFICATIONS

Product specifications and accessories may be changed at any time based on improvements and other reasons.

It is our practice to change model numbers when published ratings or features are changed, or when significant construction changes are made. However, some specifications of the products may be changed without any notice. When in doubt, special model numbers may be assigned to fix or establish key specifications for your application on your request. Please consult with your OMRON representative at any time to confirm actual specifications of purchased products.

DIMENSIONS AND WEIGHTS

Dimensions and weights are nominal and are not to be used for manufacturing purposes, even when tolerances are shown.

PERFORMANCE DATA

Performance data given in this catalog is provided as a guide for the user in determining suitability and does not constitute a warranty. It may represent the result of OMRON's test conditions, and the users must correlate it to actual application requirements. Actual performance is subject to the OMRON Warranty and Limitations of Liability.

ERRORS AND OMISSIONS

The information in this document has been carefully checked and is believed to be accurate; however, no responsibility is assumed for clerical, typographical, or proofreading errors, or omissions.

2009.12

In the interest of product improvement, specifications are subject to change without notice.

OMRON Corporation
Industrial Automation Company

<http://www.ia.omron.com/>

(c)Copyright OMRON Corporation 2009 All Right Reserved.