

Temperature Controllers

E5CSV

CSM_E5CSV_DS_E_7_1

Easy Setting Using DIP Switch and Simple Functions in DIN 48 × 48 mm-size Temperature Controllers

- Easy setting using DIP switch.
- Models with two alarms added to Series, ideal for temperature alarm applications.
- Universal-input (thermocouple/platinum resistance thermometer) models also available.
- Clearly visible digital display with character height of 13.5 mm.
- Models available with black in addition to white cases.
- RoHS compliant.



Refer to *Safety Precautions for All Temperature Controllers*.

Refer to *E5CS/E5CSV Operation* for operating procedures.

Model Number Structure

Model Number Legend

Models with Terminal Blocks

E5CSV-□□□□-□
1 2 3 4 5

1. Control Outputs

- R: Relay
- Q: Voltage for driving SSR

2. Alarm Outputs

- Blank: No alarm
- 1: 1 alarm
- 2: 2 alarms

3. Input

- KJ: Thermocouple
- P: Platinum resistance thermometer
- T: Thermocouple/platinum resistance thermometer (universal-input)

4. Power Supply Voltage

- Blank: 100 to 240 VAC
- D: 24 VAC/VDC

5. Case Color

- Blank: Black
- W: Light gray

Note: A functional explanation is provided here for illustration, but models are not necessarily available for all possible combinations. Refer to *Ordering Information* when ordering.

Examples

- Relay control output, without alarm, thermocouple input, light gray case: E5CSV-RKJ-W
- Relay control output, one alarm output, platinum resistance thermometer input, black case: E5CSV-R1P-W

Ordering Information

■ List of Models

**Case Color: Light Gray, Thermocouple or Platinum Resistance Thermometer,
Power Supply Voltage: 100 to 240 VAC**

Size	Type	Control modes	Alarms	Outputs	Model with thermocouple	Model with platinum resistance thermometer
E5CSV 48 × 48mm	Terminal block	ON/OFF or PID	1	Relay	E5CSV-R1KJ-W	E5CSV-R1P-W
				Voltage (for driving SSR)	E5CSV-Q1KJ-W	E5CSV-Q1P-W

Case Color: Light Gray, Thermocouple, Power Supply Voltage: 24 VAC/VDC

Size	Type	Control modes	Alarms	Outputs	Model with thermocouple
E5CSV 48 × 48mm	Terminal block	ON/OFF or PID	1	Relay	E5CSV-R1KJD-W

Case Color: Light Gray, Universal-input, Power Supply Voltage: 100 to 240 VAC

Size	Type	Control modes	Alarms	Outputs	Model with universal-input (thermocouple or platinum resistance thermometer)
E5CSV 48 × 48mm	Terminal block	ON/OFF or PID	0	Relay	E5CSV-RT
				Voltage (for driving SSR)	E5CSV-QT
			1	Relay	E5CSV-R1T
				Voltage (for driving SSR)	E5CSV-Q1T
			2 (See note.)	Relay	E5CSV-R2T
				Voltage (for driving SSR)	E5CSV-Q2T

Note: There is no alarm output 2 mode switch. The default setting for alarm output 2 is for the upper limit alarm mode. To change the setting, change the alarm type for alarm output 2 in initial setting level 5. For details, refer to the "E5CSV/E5CS-U Digital Temperature Controller User's Manual" (Cat. No. H140-E1-01).

Case Color: Black, Universal-input, Power Supply Voltage: 24 VAC/VDC

Size	Type	Control modes	Alarms	Outputs	Model with universal-input (thermocouple or platinum resistance thermometer)
E5CSV 48 × 48mm	Terminal block	ON/OFF or PID	0	Relay	E5CSV-RTD
				Voltage (for driving SSR)	E5CSV-QTD
			1	Relay	E5CSV-R1TD
				Voltage (for driving SSR)	E5CSV-Q1TD
			2 (See note.)	Relay	E5CSV-R2TD
				Voltage (for driving SSR)	E5CSV-Q2TD

Note: There is no alarm output 2 mode switch. The default setting for alarm output 2 is for the upper limit alarm mode. To change the setting, change the alarm type for alarm output 2 in initial setting level 5. For details, refer to the "E5CSV/E5CS-U Digital Temperature Controller User's Manual" (Cat. No. H140-E1-01).

■ Accessories (Order Separately)

Protective Cover

Type	Model
Hard Protective Cover	Y92A-48B

Terminal Cover

Model
E53-COV10

Terminal Cover

(For Controllers after the design change scheduled for October 2010)

Model
E53-COV17

Note: The E53-COV10 Terminal Cover cannot be mounted to Controllers that are manufactured after the design change scheduled for October 2010

Rubber Packing

Model
Y92S-29

Note: The Rubber Packing is provided with the Digital Controller.

Specifications

■ Ratings

Supply voltage		100 to 240 VAC, 50/60 Hz 24 VAC, 50/60 Hz; 24 VDC
Operating voltage range		85% to 110% of rated supply voltage
Power consumption		100 to 240 VAC: 5 VA 24 VAC: 3 VA, 24 VDC: 2 W
Sensor input		Thermocouple input type: K, J, L Platinum resistance thermometer input type: Pt100, JPt100 Universal-input (thermocouple/platinum resistance thermometer) type: K, J, L, T, U, N, R, Pt100, JPt100
Control output	Relay output	SPST-NO, 250 VAC, 3A (resistive load)
	Voltage output (for driving the SSR)	12 VDC, 21 mA (with short-circuit protection circuit)
Control method		ON/OFF or 2-PID (with auto-tuning)
Alarm output		SPST-NO, 250 VAC, 1A (resistive load)
Setting method		Digital setting using front panel keys
Indication method		7-segment digital display (character height: 13.5 mm) and deviation indicators
Other functions		<ul style="list-style-type: none"> • Setting change prohibit (key protection) • Input shift • Temperature unit change (°C/°F) • Direct/reverse operation • Temperature range, Sensor switching (K/J/L, Pt100/JPt100) • Switching is performed between a thermocouple and platinum resistance thermometer for universal-input models. • Control period switching • 8-mode alarm output • Sensor error detection
Ambient operating temperature		-10 to 55°C (with no condensation or icing); with 3-year guarantee: -10 to 50°C
Ambient operating humidity		25% to 85%
Storage temperature		-25 to 65°C (with no condensation or icing)

- Note:** 1. Do not use an inverter output as the power supply. (Refer to *Safety Precautions for All Temperature Controllers*.)
2. Models for 24 VAC/DC can also be manufactured.

■ Characteristics

Setting accuracy	Thermocouple (See note 1.): (±0.5% of indication value or ±1°C, whichever is greater) ±1 digit max. Platinum resistance thermometer (See note 2.): (±0.5% of indication value or ±1°C, whichever is greater) ±1 digit max.	
Indication accuracy (ambient temperature of 23°C)		
Influence of temperature	R thermocouple inputs: (±1% of PV or ±10°C, whichever is greater) ±1 digit max. Other thermocouple inputs: (±1% of PV or ±4°C, whichever is greater) ±1 digit max.	
Influence of voltage	Platinum resistance thermometer inputs: (±1% of PV or ±2°C, whichever is greater) ±1 digit max.	
Hysteresis (for ON/OFF control)	0.2% FS (0.1% FS for universal-input (thermocouple/platinum resistance thermometer) models)	
Proportional band (P)	1 to 999°C (automatic adjustment using auto-tuning/self-tuning)	
Integral time (I)	1 to 1,999 s (automatic adjustment using auto-tuning/self-tuning)	
Derivative time (D)	1 to 1,999 s (automatic adjustment using auto-tuning/self-tuning)	
Alarm output range	Absolute-value alarm: Same as the control range Other: 0 to input setting range full scale (°C or °F) Alarm hysteresis: 0.2°C or °F (fixed)	
Control period	2/20 s	
Sampling period	500 ms	
Insulation resistance	20 MΩ min. (at 500 VDC)	
Dielectric strength	2,000 VAC, 50/60 Hz for 1 min between current-carrying terminals of different polarity	
Vibration resistance	Malfunction	10 to 55 Hz, 20 m/s ² for 10 min each in X, Y, and Z directions
	Destruction	10 to 55 Hz, 0.75-mm single amplitude for 2 hr each in X, Y, and Z directions
Shock resistance	Malfunction	100 m/s ² min., 3 times each in 6 directions
	Destruction	300 m/s ² min., 3 times each in 6 directions
Life expectancy	Electrical	100,000 operations min. (relay output models)
Weight	Approx. 120 g (Controller only)	
Degree of protection	Front panel: Equivalent to IP66; Rear case: IP20; Terminals: IP00	
Memory protection	EEPROM (non-volatile memory) (number of writes: 1,000,000)	
EMC	EMI Radiated:	EN 55011 Group 1 Class A
	EMI Conducted:	EN 55011 Group 1 Class A
	ESD Immunity:	EN 61000-4-2: 4 kV contact discharge (level 2) 8 kV air discharge (level 3)
	Radiated Electromagnetic Field Immunity:	EN 61000-4-3: 10 V/m (80-1000 MHz, 1.4-2.0 GHz amplitude modulated) (level 3) 10 V/m (900 MHz pulse modulated)
	Conducted Disturbance Immunity:	EN 61000-4-6: 3 V (0.15 to 80 MHz) (level 2)
Noise Immunity (First Transient Burst Noise):	EN 61000-4-4	
Burst Immunity:	2 kV power-line (level 3), 1 kV I/O signal-line (level 3)	
Surge Immunity:	EN 61000-4-5: Power line: Normal mode 1 kV; Common mode 2 kV Output line (relay output): Normal mode 1 kV; Common mode 2 kV	
Voltage Dip/Interrupting Immunity:	EN 61000-4-11 0.5 cycle, 100% (rated voltage)	
Approved standards	UL 61010-1 (listing) CSA C22.2 No.1010-1	
Conformed standards	EN 61326, EN 61010-1, IEC 61010-1 VDE 0106 Part 100 (finger protection), when the terminal cover is mounted.	

- Note:** 1. The following exceptions apply to thermocouples.
 - U, L: ±2°C ±1 digit max.
 - R: ±3°C ±1 digit max. at 200°C or less
2. The following exceptions apply to platinum resistance thermometers.
Input set values 0, 1, 2, 3 for E5CSV: 0.5% FS ±1 digit max.

Temperature Range

Thermocouple Input Models

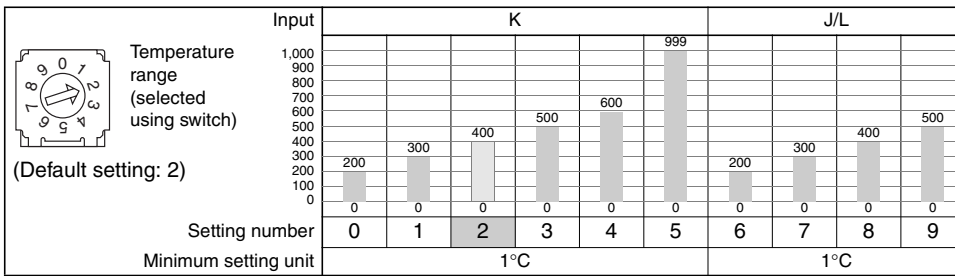

The shaded value indicates the default setting status.

Platinum Resistance Thermometer Input Models

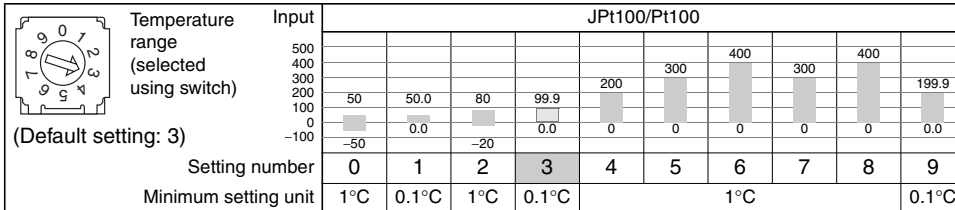

The shaded value indicates the default setting status.

Universal-input (Thermocouple/Platinum Resistance Thermometer) Models

Using Thermocouple Sensors, Control Mode Switch 5: OFF

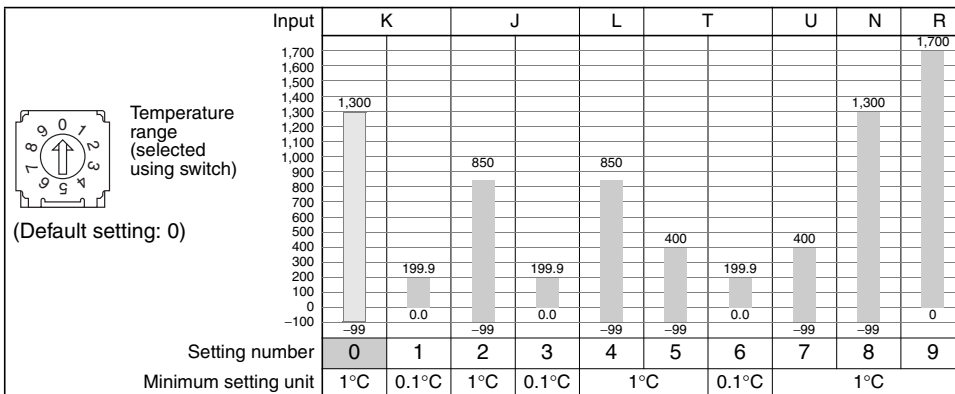

The shaded value indicates the default setting status.

Using Platinum Resistance Thermometers, Control Mode Switch 5: ON

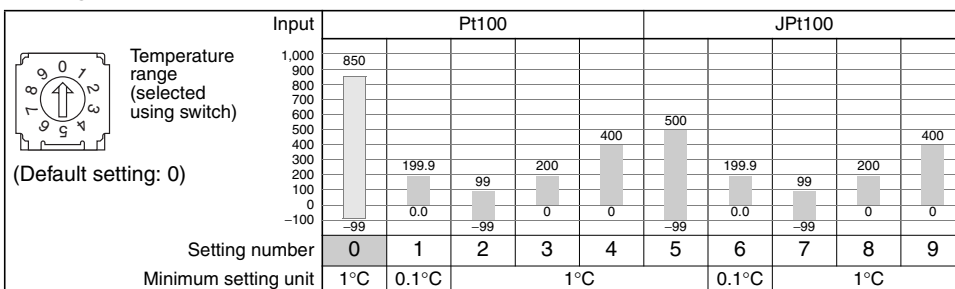

The shaded value indicates the default setting status.

External Connection Diagram

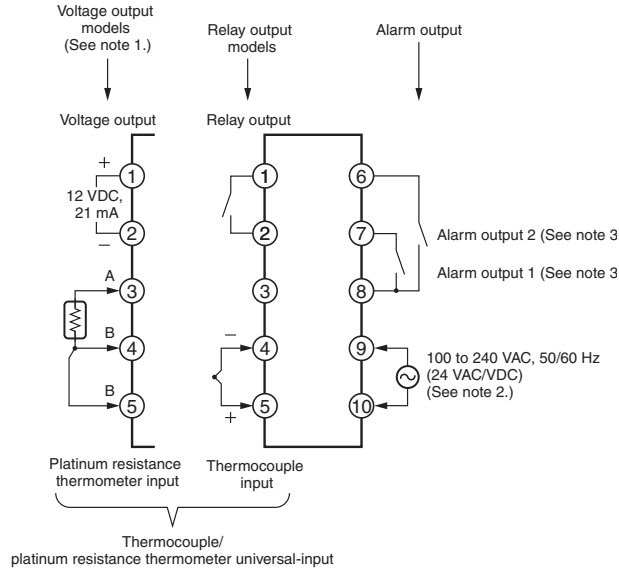

- Note:**
1. The voltage output (12 VDC, 21 mA) is not electrically isolated from the internal circuits. When using a grounding thermocouple, do not connect output terminals 1 or 2 to ground. Otherwise, unwanted current paths will cause measurement errors.
 2. Models with 100 to 240 VAC and 24 VAC/VDC are separate. Models using 24 VDC have no polarity.
 3. The number of alarm outputs depends on the model.

Nomenclature

E5CSV Models with Terminal Blocks



Dimensions

Note: All units are in millimeters unless otherwise indicated.

Controller

E5CSV

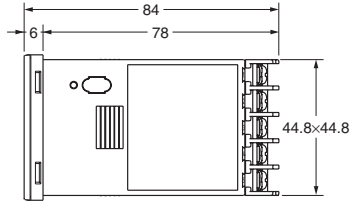
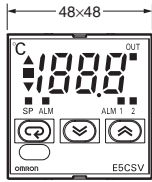
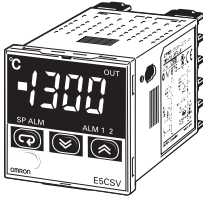

Panel Cutout Dimensions

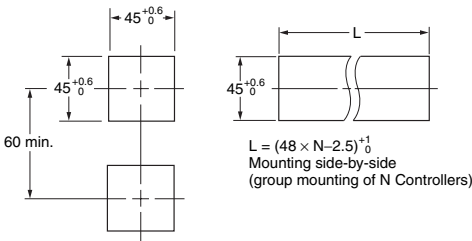

Note: Terminals cannot be removed.

E5CSV + Adapter for Flush Mounting (Provided)

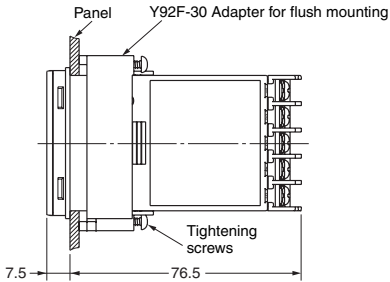
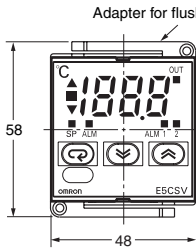
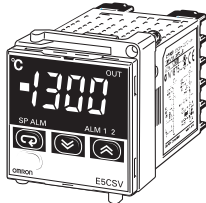
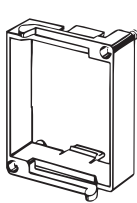

Note: 1. The recommended panel thickness is 1 to 4 mm.
2. Group mounting is possible in one direction only.

Accessories (Order Separately)

Hard Protective Cover

The Y92A-48B Protective Cover (hard type) is available for the following applications.

- To protect the set from dust and dirt.
- To prevent the panel from being accidentally touched causing displacement of set values.
- To provide effective protection against water droplets.



Terminal Cover

E53-COV10

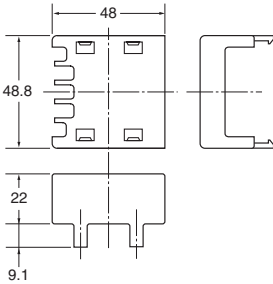
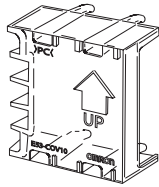

E53-COV17

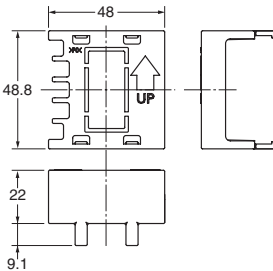
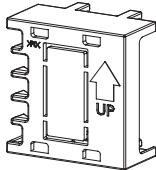

(For Controllers after the design change scheduled for October 2010)

Rubber Packing

Y92S-29 (for DIN48 x 48)

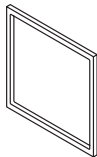

Order the Rubber Packing separately if it becomes lost or damaged. The Rubber Packing can be used to achieve an IP66 degree of protection for models with terminal blocks.

(Deterioration, shrinking, or hardening of the rubber packing may occur depending on the operating environment. Therefore, periodic replacement is recommended to ensure the level of waterproofing specified in NEMA4. The time for periodic replacement depends on the operating environment. Be sure to confirm this point at your site. Consider one year a rough standard. OMRON shall not be liable for the level of water resistance if the customer does not perform periodic replacement.)
The Rubber Packing does not need to be attached if a waterproof structure is not required.

Safety Precautions

Refer to *Safety Precautions for All Temperature Controllers*.
Refer to *E5CS/E5CSV Operation* for operating procedures.

ALL DIMENSIONS SHOWN ARE IN MILLIMETERS.
To convert millimeters into inches, multiply by 0.03937. To convert grams into ounces, multiply by 0.03527.

In the interest of product improvement, specifications are subject to change without notice.