

Digital Fiber Sensors

# E3X-DA-S

## High functionality digital fiber amplifier

- High functionality digital fiber amplifier with advanced timing, LED power control and signal processing functionality providing highest detection accuracy and stability even for the most challenging objects and settings.
- Power tuning function to adjust the received light to a maximum, minimum or pre-defined value
- Auto power and threshold adjustment functions for highest operational stability
- Two outputs for window monitoring or two level detections (e.g. object + object state change)



### Ordering information

Item	Function								Order code	
	Power tuning	Timer	Auto-threshold compensation (ATC)	Twin output	External input	Differential operation	Wet process 'tough mode'	Power saving 'Eco' functions (display/LED off)	NPN	PNP
Pre-wired	Yes	Yes	Yes	Yes	Yes	Yes	Yes	Yes	E3X-DA21-S 2M	E3X-DA51-S 2M
Fiber amplifier connector <sup>*1</sup>	Yes	Yes	Yes	Yes - selectable		Yes	Yes	Yes	E3X-DA7-S	E3X-DA9-S
M8 connector	3 pin	Yes	Yes	*2					E3X-DA13-S	E3X-DA43-S
	4 pin								E3X-DA14-S	E3X-DA44-S

\*1. Order fiber amplifier connector E3X-CN\_ separately

\*2. For fiber amplifiers with these functions and connecting with M8 connector, order the fiber amplifier connector models above and the pigtail connector E3X-CN21-M3J-2 with 30cm PVC cable and M8 plug.

### Fiber amplifier connectors

Shape	Type	Comment	Order code
	Fiber amplifier connector	2 m PVC cable	E3X-CN21
		30 cm PVC cable with M12 plug connector (4 pin)	E3X-CN21-M1J 0.3M
		30 cm PVC cable with M8 plug connector (4 pin)	E3X-CN21-M3J-2 0.3M

### Mounting Bracket

Appearance	Model	Quantity
	E39-L143	1

### End Plate

Appearance	Model	Quantity
	PFP-M	1

## Features

### Power tuning



### Timer functions

ON delay	OFF delay	One-shot	ON delay and OFF delay	
				<p><math>T_1</math>: ON-delay set time</p> <p><math>T_2</math>: OFF-delay set time</p> <p><math>T_1</math> and <math>T_2</math> can be set separately.</p>

Adjust the output signal length and timing

### Twin output

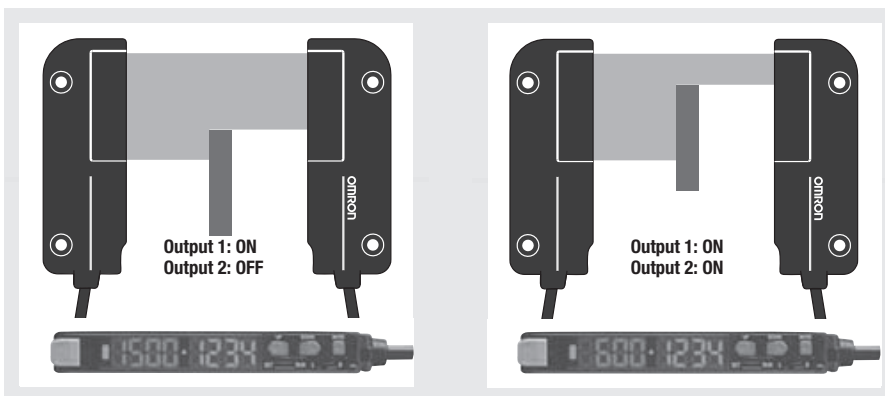

The two outputs can be used to detect two different light levels

### Differential detection



Triggering on single or double signal edges

### Active-threshold control (ATC)

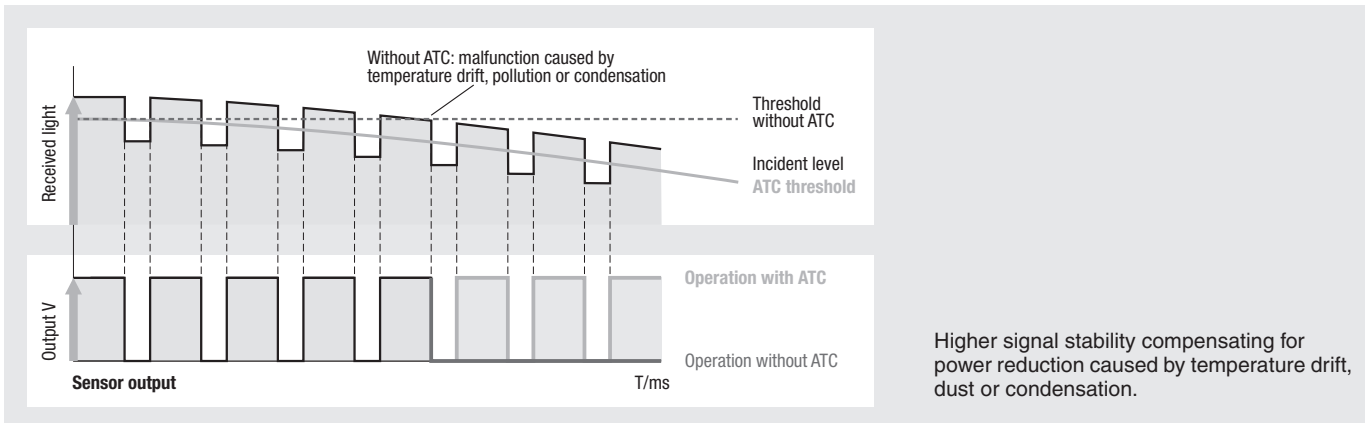

## Specifications

Item	Pre-wired models	Fiber amplifier connector models	M8 connector models	
	E3X-DA_1-S	E3X-DA7-S, E3X-DA9-S	E3X-DA_3-S, E3X-DA_4-S	
Light source (wave length)	Red LED (650 nm)		Red LED (625 nm)	
Power supply voltage	12 to 24 VDC ± 10%; ripple (p-p): 10% max			
Protective circuits	Reverse polarity protection, output short circuit protection, mutual interference prevention <sup>*1</sup>			
Response time	Super-high-speed mode <sup>*2</sup>	80 μs for operation and reset max.	55 μs for operation and reset max.	
	Standard mode	1 ms for operation and reset		
	High resolution mode	4 ms for operation and reset		
	Wet process 'tough mode'	16 ms for operation and reset	*3	
Sensitivity setting	Teaching and digital up/down keys			
Functions	Power tuning	Light emission power and reception gain, digital control method		
	Timer	OFF-delay, ON-delay, one-shot timer. 1 ms to 5 s (1 to 20 ms set in 1-ms increments, 20 to 200 ms set in 10-ms increments, 200 ms to 1 s set in 100-ms increments, and 1 to 5 s set in 1 s-increments)		
	Auto power control (APC)	LED power monitoring and auto-control function by LED emission current adjustment.		
	Active-threshold control (ATC)	Monitoring of received light average and deviation adjustment of threshold for output 1	*3	
	Twin output	Output 1: incident level Output 2: incident level or alarm output	Output 1: incident level Output 2: incident level or alarm output (not available if external input is used)	*3
	External input	External teach or function trigger (power tuning, emitter OFF, ATC start)	External teach or function trigger (power tuning, emitter OFF, ATC start) (not available if output 2 is used)	*3
	Differential operation	Single edge or double edge detection mode		*3
	Wet process 'tough mode'	Incident level triggering on floating average of received light.		*3
Power saving 'Eco' functions	LED: ON/OFF switchable (external input) Display: ON/ DIM / OFF selectable (Eco mode <sup>*4</sup> )		*3	
Digital display	Incident level + threshold or user specific			

<sup>\*1.</sup> The reverse polarity protection for the pre-wired and fiber amplifier connector models is for the power supply and the output. For M8 connector models the reverse polarity protection is for the power supply.

<sup>\*2.</sup> The communication function and mutual interference prevention function are disabled if detection is set to Super-high-speed Mode.

<sup>\*3.</sup> For fiber amplifiers with these functions and connecting with M8 connector, order the fiber amplifier connector models above and the pigtail connector E3X-CN21-M3J-2 with 30 cm PVC cable and M8 plug.

<sup>\*4.</sup> When the ECO Mode is enabled, the rated sensing distance is approx. 1/2 and the incident level is approx. 1/3 of the normal levels.

## Input Specifications

	Contact input (relay or switch)	Non-contact input (transistor)
NPN	ON: Shorted to 0 V (sourcing current: 1 mA max.). OFF: Open or shorted to Vcc.	ON: 1.5 V max. (sourcing current: 1 mA max.) OFF: Vcc - 1.5 V to Vcc (leakage current: 0.1 mA max.)
PNP	ON: Shorted to Vcc (sinking current: 3 mA max.). OFF: Open or shorted to 0 V.	ON: Vcc - 1.5 V to Vcc (sinking current: 3 mA max.) OFF: 1.5 V max. (leakage current: 0.1 mA max.)

## Amplifier unit connectors

		E3X-CN21_
Rated current	2.5 A	
Rated voltage	50 V	
Contact resistance	20 mΩ max. (20 mVDC max., 100 mA max.) (The figure is for connection to the amplifier unit and the adjacent connector. It does not include the conductor resistance of the cable.)	
No. of insertions	Destruction: 50 times (The figure for the number of insertions is for connection to the amplifier unit and the adjacent connector.)	
Materials	Housing	Polybutylene terephthalate (PBT)
	Contacts	Phosphor bronze/gold-plated nickel
Weight (packed state)	Approx. 55 g	

Exemplary sensing distances

(measured with E3X-DA51-S 2M) \*1

(Unit: mm)

Type		Tough Mode	High-resolution Mode	Standard Mode	High-speed Mode	Super-high-speed Mode
Through-beam	E32-T11N/ E32-TC200BR(B4R)	2,000	1,400	1,000	700	280
	E32-T14LR/E32-T15YR/ E32-T15ZR	750	550	450	260	100
	E32-T21R/E32-T22R/ E32-T222R/ E32-TC200FR(F4R)	450	300	250	150	60
	E32-T24R	170	120	100	50	20
	E32-TC200/E32-T12/ E32-T15X/E32-TC200B(B4)	2,800	2,000	1,550	1,000	400
	E32-T14L/E32-T15Y/ E32-T15Z	1,700	1,200	950	600	240
	E32-TC200A	2,500	1,800	1,350	900	360
	E32-TC200E/E32-T22/ E32-T222/ E32-TC200F(F4)	750	550	450	250	100
	E32-T24	450	300	250	150	60
	E32-T11/E32-T12B/ E32-T15XB	2,500	1,800	1,350	900	360
	E32-T21/E32-T221B/ E32-T22B	680	480	400	220	90
	E32-T11U	2,500	1,800	1,350	900	360
	E32-T17L	20,000*1	20,000*1	20,000*1	20,000*1	8,000

\*1. The sensing distances with M8 connector models E3X-DA[3-S and E3X-DA[4-S are approximately 50% of the exemplary values measured with E3X-DA51-S.

Reflective Models

(Unit: mm)

Type		Tough Mode	High-resolution Mode	Standard Mode	High-speed Mode	Super-high-speed Mode
Diffuse-reflective	E32-D11N/ E32-D12R/E32-D15XR/ E32-DC200BR(B4R)	840	600	350	240	100
	E32-D14LR	220	160	100	60	28
	E32-D15YR/E32-D15ZR	200	140	100	52	24
	E32-D211R/E32-D21R/ E32-D22R/ E32-DC200FR(F4R)	140	100	60	40	16
	E32-D24R	70	52	30	20	8
	E32-DC200/E32-D15X/ E32-DC200B(B4)	1,400	1,000	600	400	180
	E32-D12	1,120	800	450	320	140
	E32-D14L	560	400	220	160	72
	E32-D15Y/E32-D15Z	480	340	200	130	60
	E32-D211/E32-DC200E/ E32-D22/ E32-DC200F(F4)	360	260	160	100	44
	E32-D24	140	100	60	40	16
	E32-D11/E32-D15XB	840	600	350	240	100
	E32-D21B/E32-D221B	300	220	280	90	40
	E32-D21/E32-D22B	140	100	60	40	16
	E32-D11U	840	600	350	240	100

I/O Circuit Diagrams

NPN Output

Model	Operation mode	Timing charts	Operation selector	Output circuit
E3X-DA21-S	Light-ON	ch1/ Incident light ch2 No incident light Operation indicator ON (orange) OFF Output transistor ON OFF Load Operate (e.g., relay) Reset (Between brown and black leads)	LIGHT ON (L-ON)	
	Dark-ON	ch1/ Incident light ch2 No incident light Operation indicator ON (orange) OFF Output transistor ON OFF Load Operate (e.g., relay) Reset (Between brown and black leads)	DARK ON (D-ON)	
E3X-DA7-S, E3X-DA13-S, E3X-DA14-S	Light-ON	ch1/ Incident light ch2 No incident light Operation indicator ON (orange) OFF Output transistor ON OFF Load Operate (e.g., relay) Reset (Between brown and black leads)	LIGHT ON (L-ON)	
	Dark-ON	ch1/ Incident light ch2 No incident light Operation indicator ON (orange) OFF Output transistor ON OFF Load Operate (e.g., relay) Reset (Between brown and black leads)	DARK ON (D-ON)	

PNP Output

Model	Operation mode	Timing charts	Operation selector	Output circuit
E3X-DA51-S	Light-ON	ch1/ Incident light ch2 No incident light Operation indicator ON (orange) OFF Output transistor ON OFF Load Operate (e.g., relay) Reset (Between blue and black leads)	LIGHT ON (L-ON)	
	Dark-ON	ch1/ Incident light ch2 No incident light Operation indicator ON (orange) OFF Output transistor ON OFF Load Operate (e.g., relay) Reset (Between blue and black leads)	DARK ON (D-ON)	
E3X-DA9-S, E3X-DA43-S, E3X-DA44-S	Light-ON	ch1/ Incident light ch2 No incident light Operation indicator ON (orange) OFF Output transistor ON OFF Load Operate (e.g., relay) Reset (Between blue and black leads)	LIGHT ON (L-ON)	
	Dark-ON	ch1/ Incident light ch2 No incident light Operation indicator ON (orange) OFF Output transistor ON OFF Load Operate (e.g., relay) Reset (Between blue and black leads)	DARK ON (D-ON)	

Note: 1. Operation with area settings is as follows:  
 LIGHT ON: ON when the incident level is between the thresholds for channels 1 and 2.  
 DARK ON: OFF when the incident level is between the thresholds for channels 1 and 2.  
 2. Not available for M8 connector types E3X-DA4□-S and E3X-DA1□-S.

## Nomenclature

### Amplifier Units

E3X-DA□-S (□: 21/51/7/9)

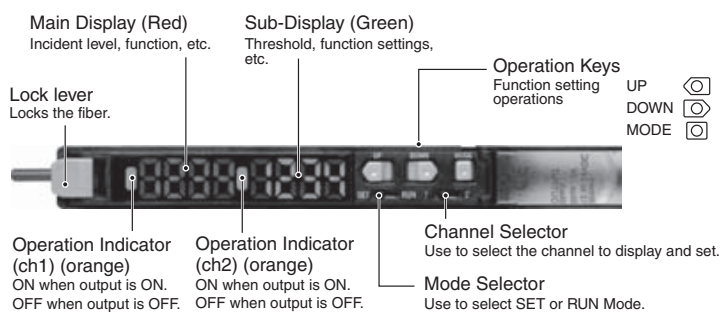

## Safety Precautions

To ensure safe operation, be sure to read and follow the *Instruction Manual* provided with the Sensor.

### WARNING

This product is not designed or rated for ensuring safety of persons either directly or indirectly. Do not use it for such purposes.



### CAUTION

Do not use the Sensor with voltage in excess of the rated voltage. Excess voltage may result in malfunction or fire.



Never use the Sensor with an AC power supply. Otherwise, explosion may result.



### Precautions for Safe Use

The following precautions must be observed to ensure safe operation of the Sensor.

1. Do not use the Sensor in an environment where explosive or flammable gas is present.
2. Do not use the Sensor in a location subject to splattering with water, streams, oils, or chemicals.
3. Do not attempt to disassemble, repair, or modify the Sensor.
4. Do not apply voltages or currents that exceed the rated range to the Sensor.
5. Do not use the Sensor in an ambient atmosphere or environment that exceeds the ratings.
6. Wire the power supply correctly, including the polarity.
7. Connect the load correctly.
8. Do not short-circuit the load at both ends.
9. Do not use the Sensor if the case is damaged.
10. Dispose of the Sensor as industrial waste.
11. Do not use the Sensor in locations subject to direct sunlight.

### Precautions for Correct Use

Do not use the product in atmospheres or environments that exceed product ratings.

#### Amplifier Unit

##### Designing

#### • Operation after Turning Power ON

The Sensor is ready to detect within 200 ms after the power supply is turned ON. If the Sensor and load are connected to separate power supplies, be sure to turn ON the Sensor first.

Time may be required for the incident level to stabilize after the power supply is turned ON.

#### • Operation at Power OFF

A pulse may be output when the power supply is turned OFF. Turn OFF the power supply to the load or the load line before turning OFF the power supply to the Sensor.

#### Mounting

- Connecting and Disconnecting Connectors

#### Mounting Connectors

1. Insert the Master or Slave Connector into the Amplifier Unit until it clicks into place.

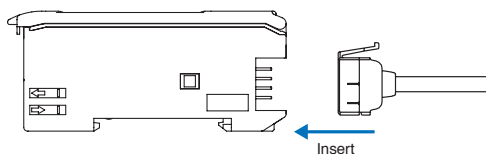

2. Attach the protective seals (provided as accessories) to the sides of master and slave connectors that are not connected.

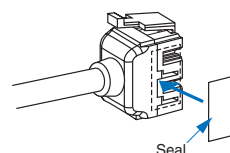

**Note:** Attach the seals to the sides with grooves.

#### Removing Connectors

1. Slide the slave Amplifier Unit away from the other Unit.
2. After the Amplifier Unit has been separated, press down on the lever on the Connector and remove it. (Do not attempt to remove a Connector without first separating the Amplifier Unit from the other Units.)

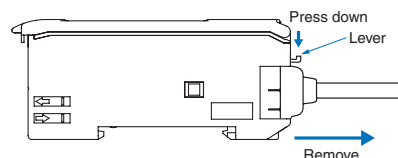

• Adding and Removing Amplifier Units

**Adding Amplifier Units**

1. Mount the Amplifier Units one at a time onto the DIN track.

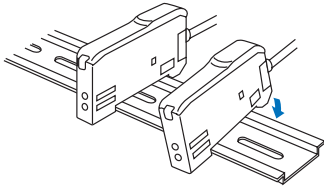

2. Slide the Amplifier Units together, line up the clips, and press the Amplifier Units together until they click into place.

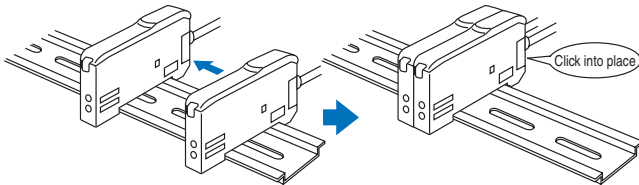

**Removing Amplifier Units**

Slide Amplifier Units away from each other, and remove from the DIN track one at a time. (Do not attempt to remove Amplifier Units from the DIN track without separating them first.)

**Note 1.** The specifications for ambient temperature will vary according to the number of Amplifier Units used together. For details, refer to *Input Specifications* on page 3.

2. Always turn OFF the power supply before joining or separating Amplifier Units.

**Mounting the End Plate (PFP-M)**

Use an End Plate if the Amplifier Unit might move due to vibration.

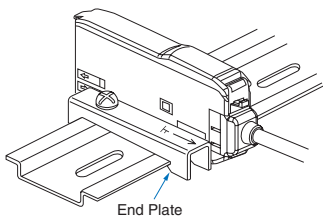

• Fiber Connection

The E3X Amplifier Unit has a lock button for easy connection of the Fiber Unit. Connect or disconnect the fibers using the following procedures:

**1. Connecting Fibers**

Open the protective cover, insert the fibers according to the fiber insertion marks on the side of the Amplifier Unit, and lower the lock lever.

**Note:** Do not pull on the fiber, apply pressure on it, or otherwise subject it to excessive force when it is attached to the Amplifier Unit. (Use a force of 0.3 N·m max.)

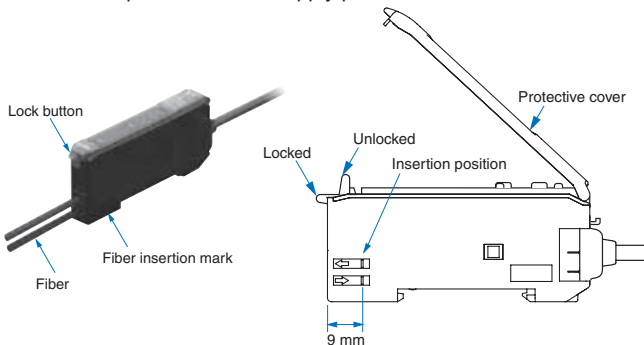

ject it to excessive force when it is attached to the Amplifier Unit. (Use a force of 0.3 N·m max.)

• Fibers with E39-F9 Attachment

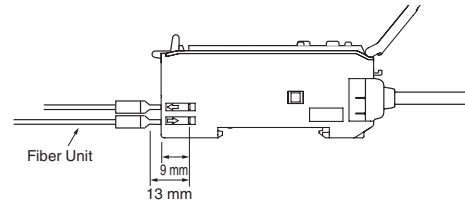

• Fibers That Cannot Be Free-Cut (with Sleeves)

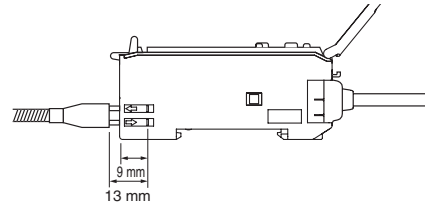

**2. Disconnecting Fibers**

Remove the protective cover and raise the lock lever to pull out the fibers.

**Note 1.** To maintain the fiber properties, confirm that the lock is released before removing the fibers.

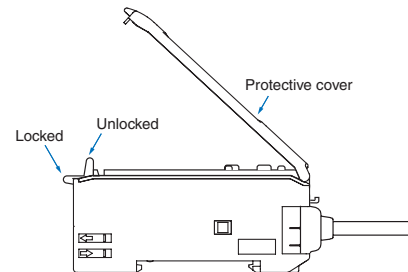

leased before removing the fibers.

2. Be sure to lock or unlock the lock button within an ambient temperature range between -10°C and 40°C.

**Adjusting**

• Mutual Interference Protection Function

The values that appear on the digital display may fluctuate somewhat due to light from other Sensors. If this occurs, you can stabilize detection by lowering the threshold to provide a greater margin in the allowable values.

• Output Short-circuits

OVER/CUR will flash on the display if the output short-circuit function operates due to a load short-circuit in a control output. If this occurs, check the load connections.

• EEPROM Writing Error

If the data is not written to the EEPROM correctly due to a power failure or static-electric noise, initialize the settings with the keys on the Amplifier Unit. ERR/EEP will flash on the display when a writing error has occurred.

• Optical Communications

Several Amplifier Units can be slid together and used in groups. Do not, however, slide the Amplifier Units or attempt to remove any of the Amplifier Units during operation.

**Others**

• Protective Cover

Always keep the protective cover in place when using the Amplifier Unit.

• Mobile Console

The E3X-MC11-SV2 Mobile Console does not currently support the new Tough Mode and ON-delay + OFF-delay timer. You also cannot use the E3X-MC-S.

• Communications Unit

Use an E3X-DRT21-S Version 3 Communications Unit.

Dimensions

Tolerance class IT16 applies to dimensions in this data sheet unless otherwise specified.

Amplifier Units

Pre-wired Models  
E3X-DA21-S  
E3X-DA51-S

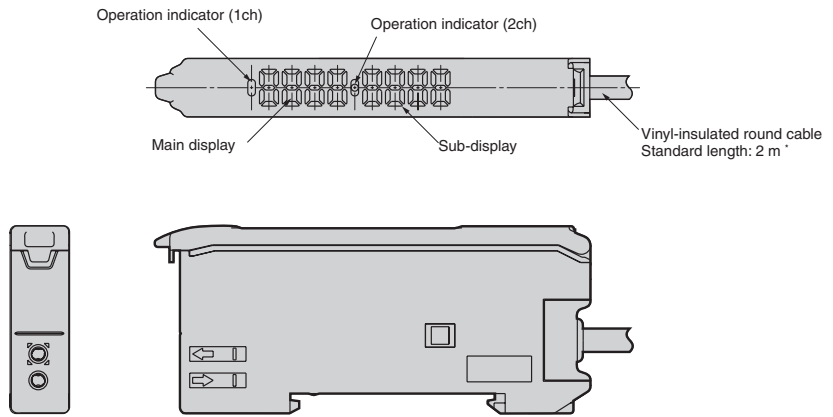

\* Cable Specifications

<b>E3X-DA21-S</b> <b>E3X-DA51-S</b>	4-dia., 5-conductor (Conductor cross section: 0.2 mm <sup>2</sup> , insulator diameter: 1.1 mm)
--	---

With Mounting Bracket Attached

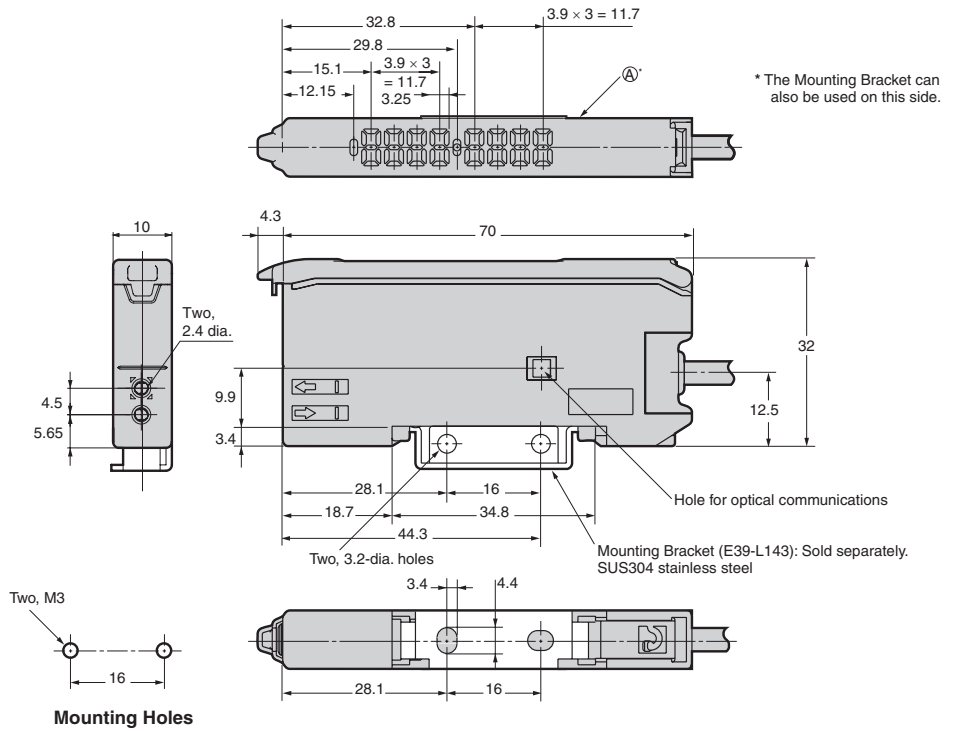

Mounting Holes



Models with fiber amplifier connectors  
 E3X-DA7-S  
 E3X-DA9-S

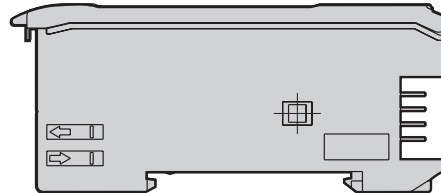
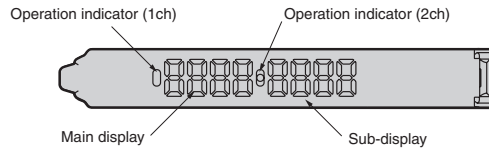
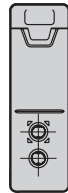

With Mounting Bracket Attached

- \*1. The Mounting Bracket can also be used on this side.
- \*2. Cable Diameters

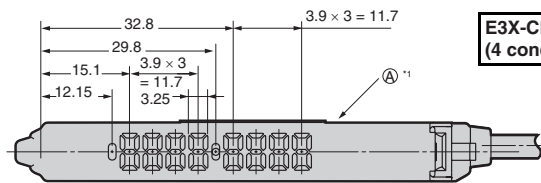

<b>E3X-CN21</b> <b>(4 conductors)</b>	4.0 dia.
--	----------

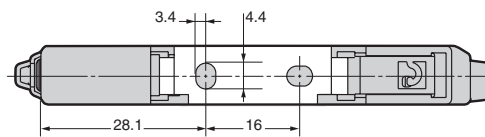
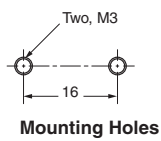
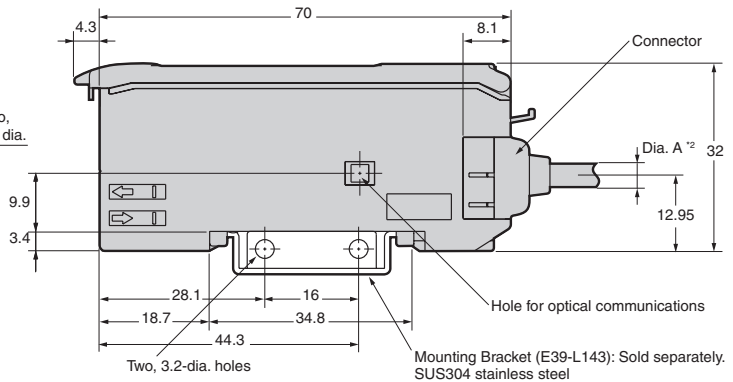
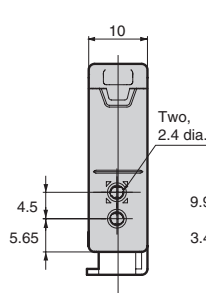

Models with M8 connectors  
 E3X-DA13-S  
 E3X-DA14-S  
 E3X-DA43-S  
 E3X-DA44-S

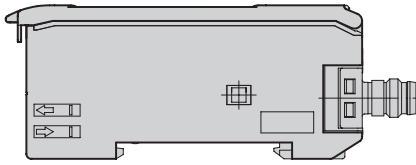
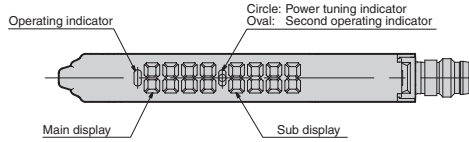

With Mounting Bracket Attached

E3X-DA13-S  
 E3X-DA43-S

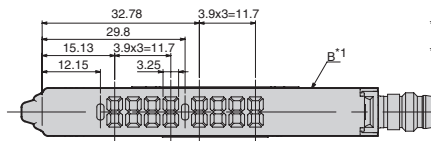

\*1. The Mounting Bracket can also be used on this side.  
 \*2. Connector size

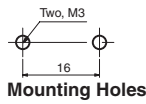
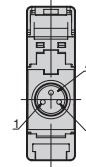
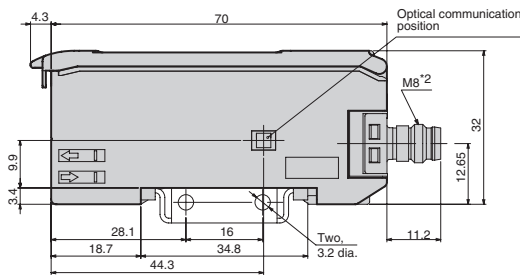
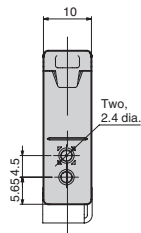

Mounting Holes

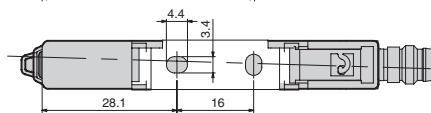

With Mounting Bracket Attached

E3X-DA14-S  
 E3X-DA44-S

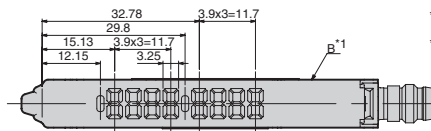

\*1. The Mounting Bracket can also be used on this side.  
 \*2. Cable Diameters

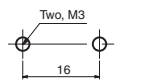
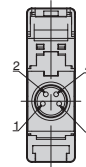
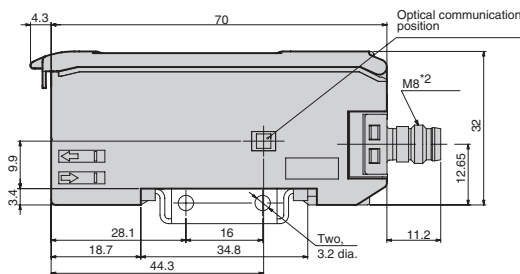
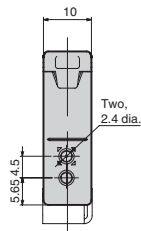

Mounting Holes

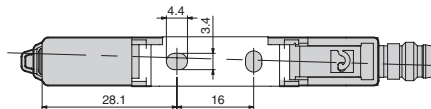

Amplifier Unit Connectors

Master Connectors  
E3X-CN21

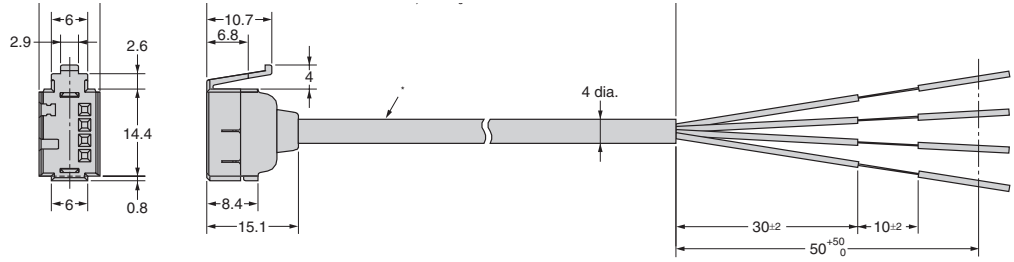
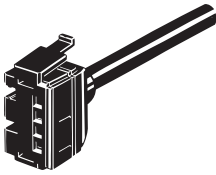

\* E3X-CN21: 4-dia. vinyl-insulated round cable with 4 conductors (Conductor cross section: 0.2 mm<sup>2</sup>, Insulator diameter: 1.1 mm)

**READ AND UNDERSTAND THIS DOCUMENT**

Please read and understand this document before using the products. Please consult your OMRON representative if you have any questions or comments.

**WARRANTY**

OMRON's exclusive warranty is that the products are free from defects in materials and workmanship for a period of one year (or other period if specified) from date of sale by OMRON.

OMRON MAKES NO WARRANTY OR REPRESENTATION, EXPRESS OR IMPLIED, REGARDING NON-INFRINGEMENT, MERCHANTABILITY, OR FITNESS FOR PARTICULAR PURPOSE OF THE PRODUCTS. ANY BUYER OR USER ACKNOWLEDGES THAT THE BUYER OR USER ALONE HAS DETERMINED THAT THE PRODUCTS WILL SUITABLY MEET THE REQUIREMENTS OF THEIR INTENDED USE. OMRON DISCLAIMS ALL OTHER WARRANTIES, EXPRESS OR IMPLIED.

**LIMITATIONS OF LIABILITY**

OMRON SHALL NOT BE RESPONSIBLE FOR SPECIAL, INDIRECT, OR CONSEQUENTIAL DAMAGES, LOSS OF PROFITS OR COMMERCIAL LOSS IN ANY WAY CONNECTED WITH THE PRODUCTS, WHETHER SUCH CLAIM IS BASED ON CONTRACT, WARRANTY, NEGLIGENCE, OR STRICT LIABILITY.

In no event shall responsibility of OMRON for any act exceed the individual price of the product on which liability is asserted.

IN NO EVENT SHALL OMRON BE RESPONSIBLE FOR WARRANTY, REPAIR, OR OTHER CLAIMS REGARDING THE PRODUCTS UNLESS OMRON'S ANALYSIS CONFIRMS THAT THE PRODUCTS WERE PROPERLY HANDLED, STORED, INSTALLED, AND MAINTAINED AND NOT SUBJECT TO CONTAMINATION, ABUSE, MISUSE, OR INAPPROPRIATE MODIFICATION OR REPAIR.

**SUITABILITY FOR USE**

THE PRODUCTS CONTAINED IN THIS DOCUMENT ARE NOT SAFETY RATED. THEY ARE NOT DESIGNED OR RATED FOR ENSURING SAFETY OF PERSONS, AND SHOULD NOT BE RELIED UPON AS A SAFETY COMPONENT OR PROTECTIVE DEVICE FOR SUCH PURPOSES. Please refer to separate catalogs for OMRON's safety rated products.

OMRON shall not be responsible for conformity with any standards, codes, or regulations that apply to the combination of products in the customer's application or use of the product.

At the customer's request, OMRON will provide applicable third party certification documents identifying ratings and limitations of use that apply to the products. This information by itself is not sufficient for a complete determination of the suitability of the products in combination with the end product, machine, system, or other application or use.

The following are some examples of applications for which particular attention must be given. This is not intended to be an exhaustive list of all possible uses of the products, nor is it intended to imply that the uses listed may be suitable for the products:

Outdoor use, uses involving potential chemical contamination or electrical interference, or conditions or uses not described in this document.

Nuclear energy control systems, combustion systems, railroad systems, aviation systems, medical equipment, amusement machines, vehicles, safety equipment, and installations subject to separate industry or government regulations. Systems, machines, and equipment that could present a risk to life or property.

Please know and observe all prohibitions of use applicable to the products.

NEVER USE THE PRODUCTS FOR AN APPLICATION INVOLVING SERIOUS RISK TO LIFE OR PROPERTY WITHOUT ENSURING THAT THE SYSTEM AS A WHOLE HAS BEEN DESIGNED TO ADDRESS THE RISKS, AND THAT THE OMRON PRODUCT IS PROPERLY RATED AND INSTALLED FOR THE INTENDED USE WITHIN THE OVERALL EQUIPMENT OR SYSTEM.

**PERFORMANCE DATA**

Performance data given in this document is provided as a guide for the user in determining suitability and does not constitute a warranty. It may represent the result of OMRON's test conditions, and the users must correlate it to actual application requirements. Actual performance is subject to the OMRON Warranty and Limitations of Liability.

**CHANGE IN SPECIFICATIONS**

Product specifications and accessories may be changed at any time based on improvements and other reasons.

It is our practice to change model numbers when published ratings or features are changed, or when significant construction changes are made. However, some specifications of the product may be changed without any notice. When in doubt, special model numbers may be assigned to fix or establish key specifications for your application on your request. Please consult with your OMRON representative at any time to confirm actual specifications of purchased products.

**DIMENSIONS AND WEIGHTS**

Dimensions and weights are nominal and are not to be used for manufacturing purposes, even when tolerances are shown.

**ERRORS AND OMISSIONS**

The information in this document has been carefully checked and is believed to be accurate; however, no responsibility is assumed for clerical, typographical, or proofreading errors, or omissions.

**PROGRAMMABLE PRODUCTS**

OMRON shall not be responsible for the user's programming of a programmable product, or any consequence thereof.

**COPYRIGHT AND COPY PERMISSION**

This document shall not be copied for sales or promotions without permission.

This document is protected by copyright and is intended solely for use in conjunction with the product. Please notify us before copying or reproducing this document in any manner, for any other purpose. If copying or transmitting this document to another, please copy or transmit it in its entirety.