

C&K E Series Sealed Miniature Rocker and Lever Handle Switches

Features/Benefits

- Sealed against solder and cleaning process contaminants
- ESD Resistance—all actuator options
- Rocker, case & bushing UL 94V-0
- RoUS compliant

Typical Applications

- Telecommunications
- Instrumentation
- Computers & peripherals

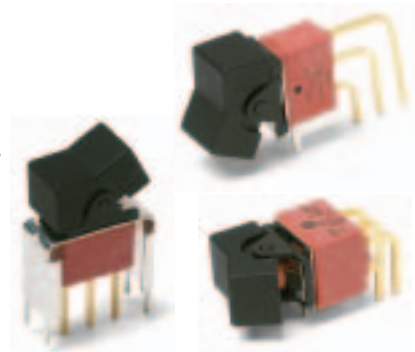

Models Available

Specifications

CONTACT RATING: B contact material: 0.4 VA max. @ 20 V AC or DC max. Q contact material (E1XX & E2XX Models): 7.5 AMPS @ 125 V AC or 28 V DC; 3 AMPS @ 250 V AC. (E3XX Models): 5 AMPS @ 125 V AC or 28 V DC; 2 AMPS @ 250 V AC. See page H-37 for additional ratings.

ELECTRICAL LIFE: E1XX and E2XX models: 40,000 make-and-break cycles at full load. E3XX models: 30,000 cycles.

CONTACT RESISTANCE: Below 10 m Ω typ. initial @ 2-4 V DC, 100 mA, for both silver and gold plated contacts.

INSULATION RESISTANCE: 10⁹ Ω min.

ELECTROSTATIC DISCHARGE (ESD) OPTION: All actuator options: 15,000 V DC max. @ sea level, actuator to terminals.

DIELECTRIC STRENGTH: 1000 Vrms min. @ sea level.

OPERATING TEMPERATURE: -30°C to 85°C.

SOLDERABILITY: Per MIL-STD-202F method 208D, or EIA RS-186E method 9 (1 hour steam aging).

Materials

CASE & BUSHING: Glass filled nylon 6/6, flame retardant, heat stabilized (UL 94V-0).

ACTUATOR: Nylon, black standard, internal o-ring seal standard with all actuators.

FRAME: Spring steel, black standard.

SWITCH SUPPORT: Brass or steel, matte-tin plated.

ACTUATOR PIVOT & MOUNTING BRACKET: Nylon.

ACTUATOR PIVOT RETAINER: Stainless steel.

CONTACTS & TERMINALS: B contact material: Copper alloy, with gold plate over nickel plate. Q contact material: Copper alloy, silver plated. See page H-37 for additional contact materials.

TERMINAL SEAL: Epoxy.

HARDWARE: Nut, Screw & Lockwasher: Stainless steel. Standoff: Nylon standard, aluminum available, consult Customer Service Center.

NOTE: Any models supplied with Q, B, G, S P & R contact material are RoHS compliant. For the latest information regarding RoHS compliance, please go to: www.ittcannon.com/rohs.

NOTE: Specifications and materials listed above are for switches with standard options. For information on specific and custom switches, consult Customer Service Center.

Build-A-Switch

To order, simply select desired option from each category and place in the appropriate box. Available options are shown and described on pages H-26 through H-39. For additional options not shown in catalog, consult Customer Service Center. All models are process sealed to withstand machine soldering temperatures and pressure wash cleaning methods.



Switch Function

- E101** SP On-None-On
- E103** SP On-Off-On
- E105** SP Mom.-Off-Mom.
- E107** SP On-Off-Mom.
- E108** SP On-None-Mom.
- E201** DP On-None-On
- E203** DP On-Off-On
- E205** DP Mom.-Off-Mom.
- E207** DP On-Off-Mom.
- E208** DP On-None-Mom.
- E211** DP On-On-On
- E213** DP On-On-Mom.
- E215** DP Mom.-On-Mom.
- E301** 3P On-None-On

Actuator

- J1** .531 long rocker
- J2** Lever
- J3** .906" long rocker
- J11** Rocker with frame
- J21** Lever with frame
- J50** .362" long rocker
- J60** Lever
- J90** Lever

Terminations

- A** Right angle, PC thru-hole
- AV2** Vertical right angle, PC thru-hole
- C** PC Thru-hole
- Z** Solder lug
- A3** Right angle, snap-in, PC thru-hole
- AV3** Vertical right angle, snap-in, PC thru-hole
- V3** .460" high, V-bracket
- V4** .630" high, V-bracket
- V5** Vertical right angle, PC thru-hole
- V6** .460" high, V-bracket
- V7** .630" high, V-bracket
- V8** .953" high, V-bracket
- V21** .555" high, V-bracket, snap-in
- V31** .460" high, V-bracket, snap-in

Contact Material

- B** Gold
- K** Gold, tin-lead
- P** Gold, matte tin
- Q** Silver
- M** Silver, tin-lead
- S** Silver, matte-tin
- G** Gold over silver
- L** Gold over silver, tin-lead
- R** Gold over silver, matte-tin

Seal

- E** Epoxy

Actuator Color

- 2** Black
- 3** Red

Frame Color

- 2** Black
- NONE** No frame color required

Metal Frame Color

- (J11, J21 Actuators)
- 2** Black

Rocker



Dimensions are shown: Inch (mm)
Specifications and dimensions subject to change

C&K E Series Sealed Miniature Rocker and Lever Handle Switches

SWITCH FUNCTION

NO. POLES	MODEL NO.	SWITCH FUNCTION			CONNECTED TERMINALS			SCHEMATIC
		POS. 1	POS. 2	POS. 3	POS. 1	POS. 2	POS. 3	
		C&K marking on opposite side			C&K marking on opposite side			
SP	E101	ON	NONE	ON	2-3	N/A	2-1	
	E103	ON	OFF	ON				
	E105	MOM.	OFF	MOM.				
	E107	ON	OFF	MOM.				
	E108	ON	NONE	MOM.				
SPDT								
DP	E201	ON	NONE	ON	2-3-5-6	N/A	2-1,5-4	
	E203	ON	OFF	ON				
	E205	MOM.	OFF	MOM.				
	E207	ON	OFF	MOM.				
	E208	ON	NONE	MOM.				
	E211**	ON	ON	ON				
	E213**	ON	ON	MOM.				
	E215**	MOM.	ON	MOM.				
DPDT								

MOM. = Momentary

** Wiring for 3-way switch, Hardware available separately, see Technical Data section of this catalog.

All models with all options when ordered with G, L, M or Q contact material.

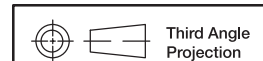

Dimensions are shown: Inch (mm)

Specifications and dimensions subject to change

Rocker



H

C&K E Series Sealed Miniature Rocker and Lever Handle Switches

SWITCH FUNCTION

NO. POLES	MODEL NO.	SWITCH FUNCTION			CONNECTED TERMINALS			SCHEMATIC
		POS. 1	POS. 2	POS. 3	POS. 1	POS. 2	POS. 3	
3P	E301							<p>3PDT</p>
		C&K marking on opposite side			C&K marking on opposite side			
		ON	NONE	ON	2-3,5-6,8-9	N/A	2-1,5-4,8-7	

3PDT

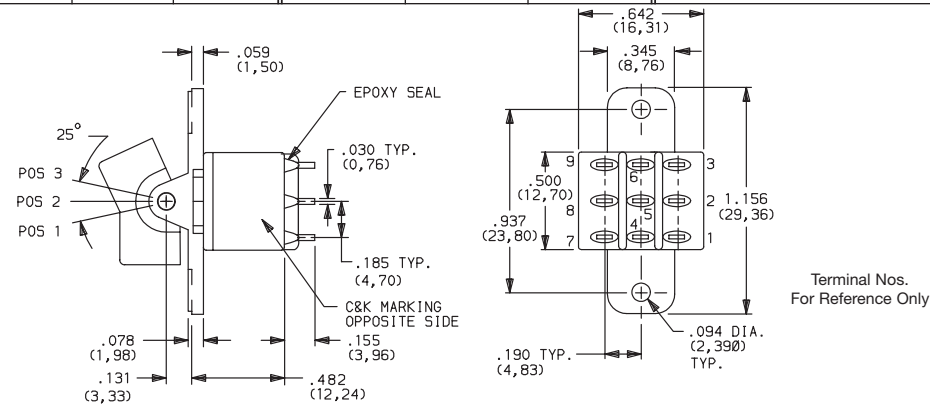

Part number shown: E301J1ZBE2

MOM. = Momentary

All models with all options when ordered with G, L, M or Q contact material.

** Wiring for 3-way switch, see Technical Data section of this catalog.

ACTUATOR-PANEL REAR MOUNT

OPTION CODE	ACTUATOR COLOR
2	BLACK
3	RED

Finish: Matte. Other colors, custom actuator markings and legends available, consult Customer Service Center.

NOTE: Hardware: two each—mounting screws, nuts, lockwashers and standoffs for 1/8 inch thick panel are supplied standard on switches with panel mounting bracket. Internal o-ring actuator seal standard. Actuators available separately, see page H-37. Hardware available separately, see Technical Data section of this catalog. J1, J2 actuators available with C, Z or Z3 terminations.

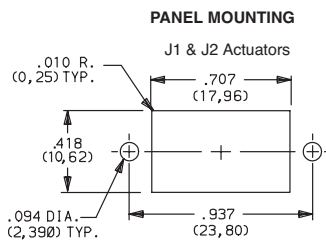
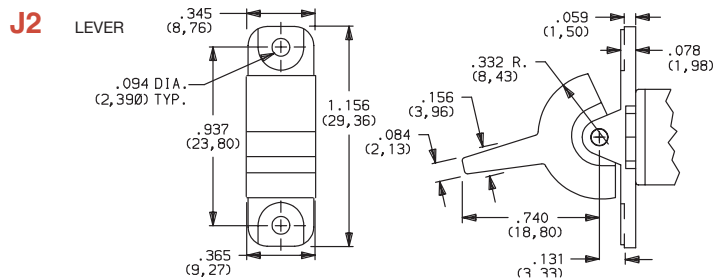
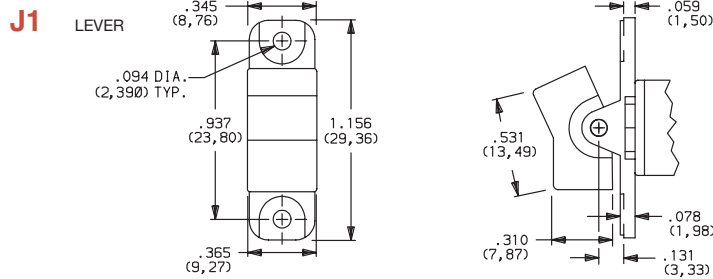

Rocker



Third Angle Projection
Dimensions are shown: Inch (mm)
Specifications and dimensions subject to change



C&K E Series Sealed Miniature Rocker and Lever Handle Switches

ACTUATOR-REAR MOUNT

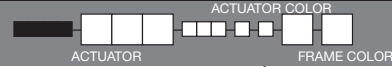

J11 ROCKER WITH FRAME

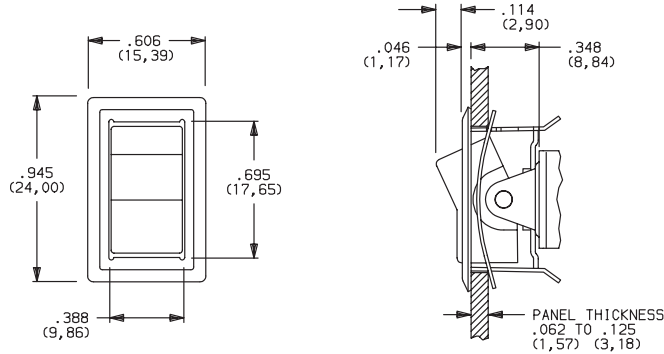
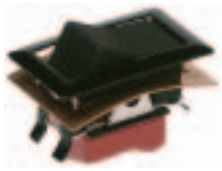

OPTION CODE	ACTUATOR COLOR
2	BLACK
3	RED

OPTION CODE	FRAME COLOR
2	BLACK

NOTE: This option has reduced anti-static capability.

J21 LEVER WITH FRAME

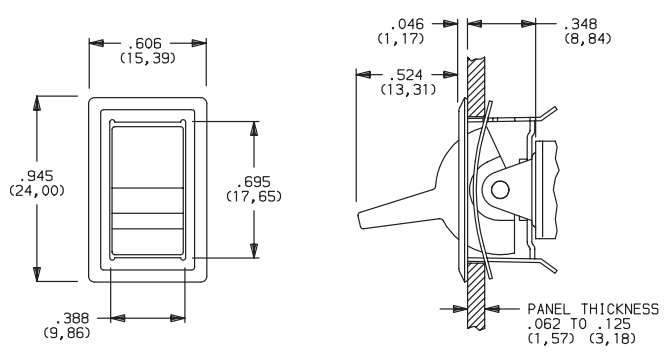

Actuator finish: Matte, frame finish: gloss. Other colors, custom actuator markings and legends available, consult Customer Service Center.

NOTE: Internal o-ring actuator seal standard. Actuators & frames available separately, see page H-37. Hardware available separately, see Technical Data section of this catalog. N, J11 & J21 actuators available with C, Z & Z3 terminations.

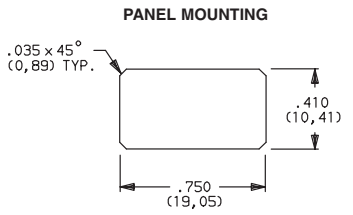

NOTE: This option has reduced anti-static capability.

ACTUATOR-PC MOUNT

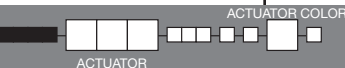

J1 ROCKER

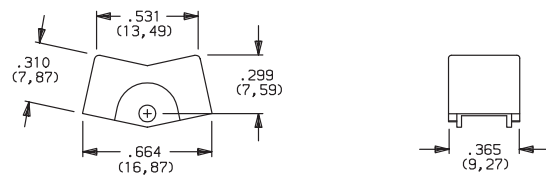

OPTION CODE	ACTUATOR COLOR
2	BLACK
3	RED

J2 LEVER

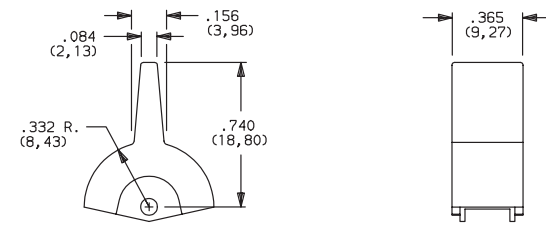

Finish: Matte. Other colors, custom actuator markings and legends available, consult Customer Service Center.

NOTE: Hardware: two each—mounting screws, nuts, lockwashers and standoffs for 1/8 inch thick panel are supplied standard on switches with panel mounting bracket. Internal o-ring actuator seal standard. Actuators available separately, see page H-37. Hardware available separately, see Technical Data section of this catalog. J1, J2 actuators available with A, A3, AV2, AV3, V2-V61 terminations.



Third Angle Projection
Dimensions are shown: Inch (mm)
Specifications and dimensions subject to change



Rocker



H

C&K E Series Sealed Miniature Rocker and Lever Handle Switches

ACTUATOR-PC MOUNT

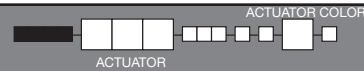

OPTION CODE	ACTUATOR COLOR
2	BLACK
3	RED

Finish: Matte. Other colors, custom actuator markings and legends available, consult Customer Service Center.

NOTE: Hardware: two each—mounting screws, nuts, lockwashers and standoffs for 1/8 inch thick panel are supplied standard on switches with panel mounting bracket. Internal o-ring actuator seal standard. Actuators available separately, see page H-37. Hardware available separately, see Technical Data section of this catalog.

J3 actuators available with AV2, AV3 & V2-V61 terminations. Some permissible actuator/termination combinations may lack clearance between actuator and PC board, and care must be exercised to accommodate this condition.

J50, J60 & J90 actuators available with A, AV2, AV3, V2 - V61 terminations.

J3 ROCKER

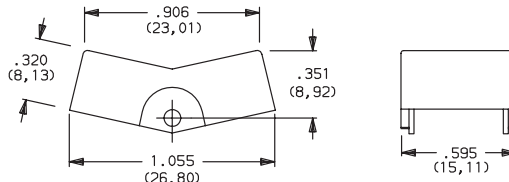

J50 ROCKER

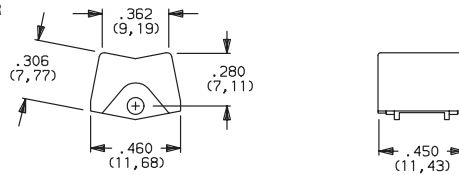

J60 LEVER

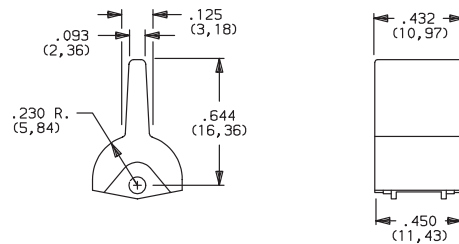

J90 LEVER

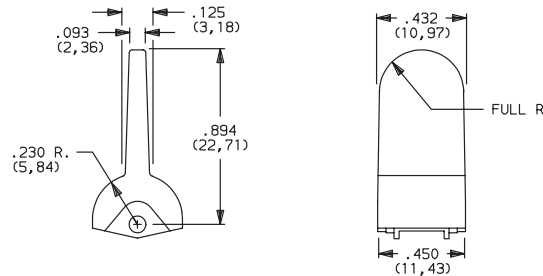

TERMINATIONS



Z SOLDER LUG

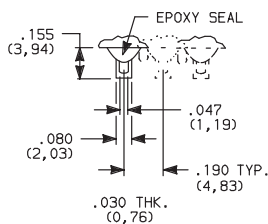

C PC THRU-HOLE

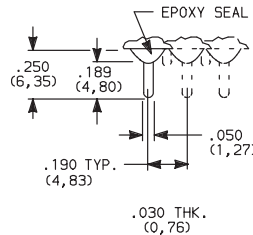

PC MOUNTING

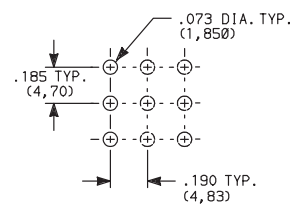

SPDT thru 3PDT

Not available with K, L, P, S, & R or M contact materials. Available actuators, see page H-37.

SPDT thru 3PDT



Dimensions are shown: Inch (mm)
Specifications and dimensions subject to change

Rocker



H



C&K E Series Sealed Miniature Rocker and Lever Handle Switches

TERMINATIONS

Z3 QUICK CONNECT

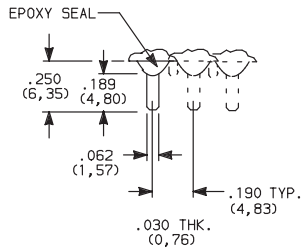

Not available with K, L, P, S, & R or M contact materials. Available actuators, see pages H-28 thru H-30. Mating quick connector available; order part number 530100000, page H-38.

SPDT thru 3PDT

A RIGHT ANGLE, PC THRU-HOLE



E101J1ABE2
Horizontal Actuation
SPDT

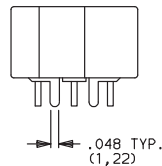

Actuator Shown In Pos. 1

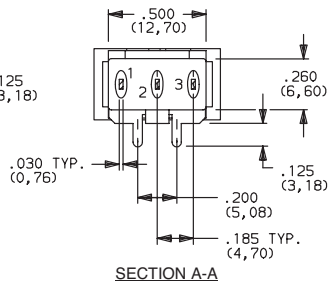
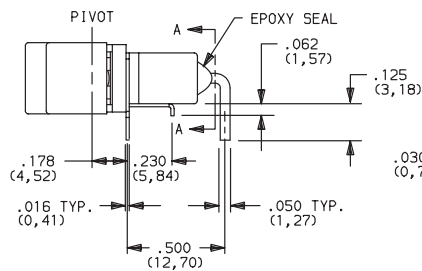

A3 RIGHT ANGLE, SNAP-IN, PC THRU-HOLE

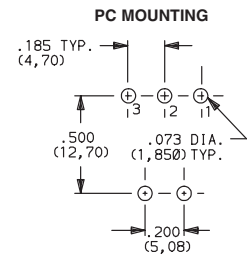
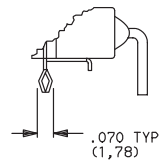
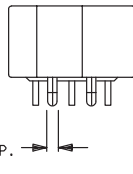

NOTE: Not available with J3, J50, J60 and J90 actuators. Available actuators, see pages H-28 thru H-30. Terminal bend radii and lead-in manufacturing option.

NOTE: PC mounting pattern must clear switch support leg.

A RIGHT ANGLE, PC THRU-HOLE



E201J1ABE2
Horizontal Actuation
DPDT

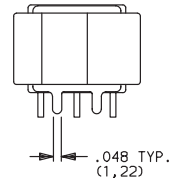

Actuator Shown In Pos. 1

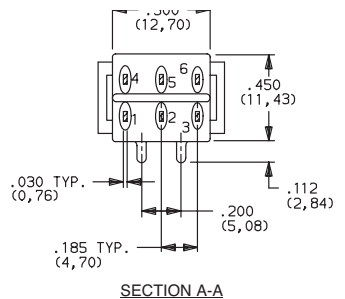
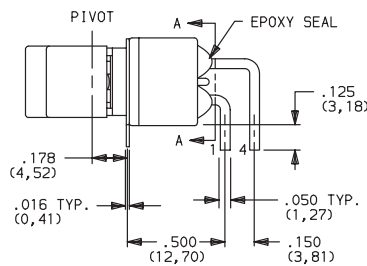

A3 RIGHT ANGLE, SNAP-IN, PC THRU-HOLE

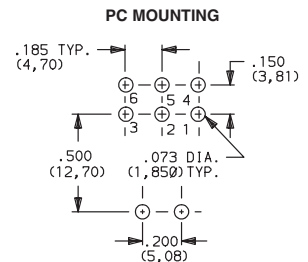
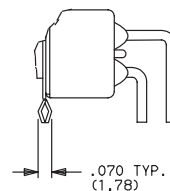
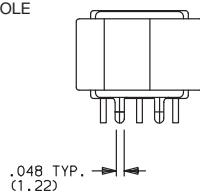

NOTE: Not available with J3 actuator. Available actuators, see pages H-28 and H-30. Terminal bend radii and lead-in manufacturing option.

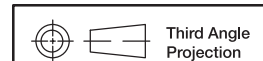

Dimensions are shown: Inch (mm)
Specifications and dimensions subject to change

Rocker



H

C&K E Series Sealed Miniature Rocker and Lever Handle Switches

TERMINATIONS

A RIGHT ANGLE, PC THRU-HOLE

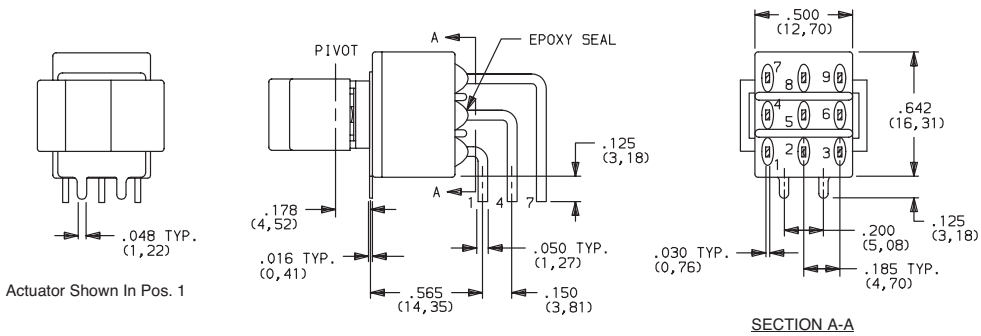

E301J1ABE2
Horizontal Actuation
3PDT

PC MOUNTING

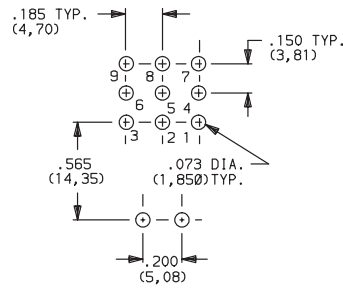

NOTE: Terminal bend radii and lead-in manufacturing option.
Available actuators, see pages H-28 and H-30.

AV2 VERTICAL RIGHT ANGLE, PC THRU-HOLE, .150" PITCH

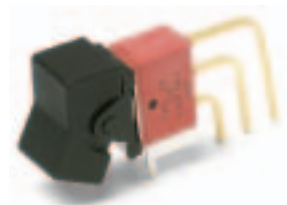
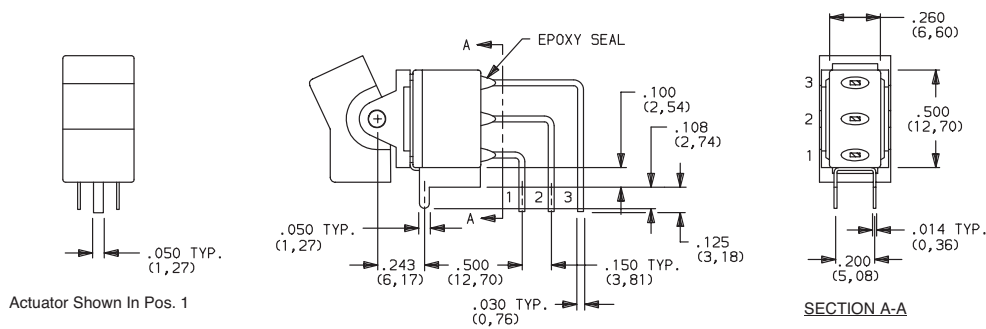

E101J1AV2BE2
Vertical Actuation
SPDT

AV3 VERTICAL RIGHT ANGLE, SNAP-IN, PC THRU-HOLE, .150" PITCH

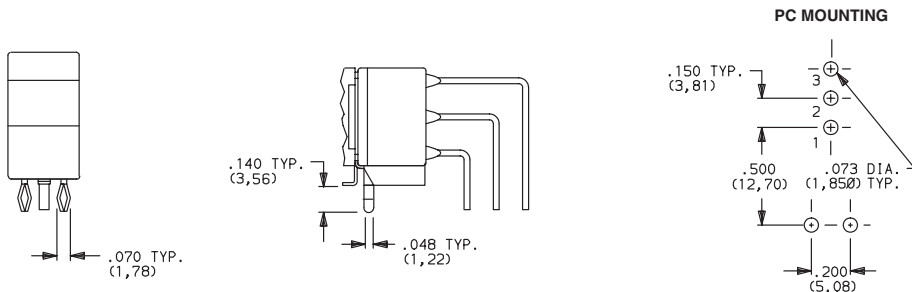

NOTE: Terminal bend radii and lead-in manufacturing option.
Available actuators, see pages H-28 and H-30.

Rocker



H



Dimensions are shown: Inch (mm)
Specifications and dimensions subject to change

www.ittcannon.com

C&K E Series Sealed Miniature Rocker and Lever Handle Switches

TERMINATIONS

AV2 VERTICAL RIGHT ANGLE, PC THRU-HOLE,
.150" PITCH

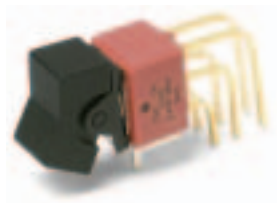

E201J1AV2BE2
Vertical Actuation
DPDT

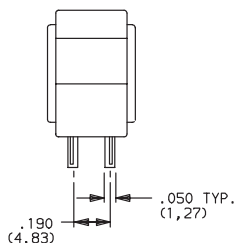

Actuator Shown In Pos. 1

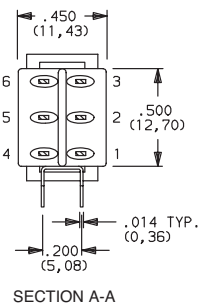
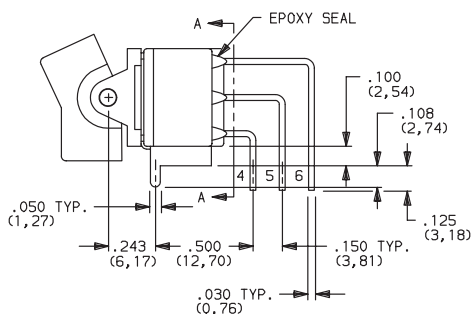

AV3 VERTICAL RIGHT ANGLE, SNAP-IN, PC THRU-HOLE,
.150" PITCH

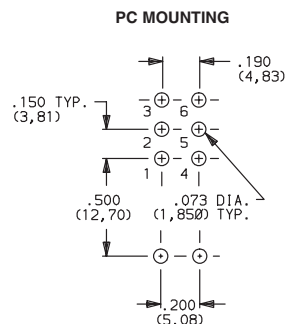
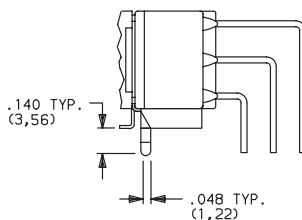
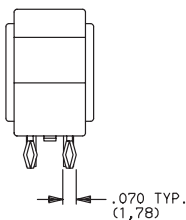

NOTE: Terminal bend radii and lead-in manufacturing option.
Available actuators, see pages H-28 and H-30.

AV2 VERTICAL RIGHT ANGLE, PC THRU-HOLE,
.150" PITCH

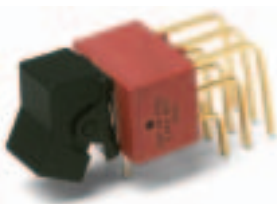

E301J1AV2BE2
Vertical Actuation
3PDT

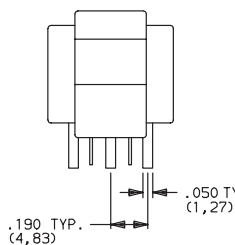

Actuator Shown In Pos. 1

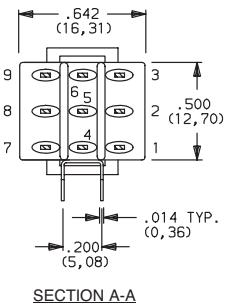
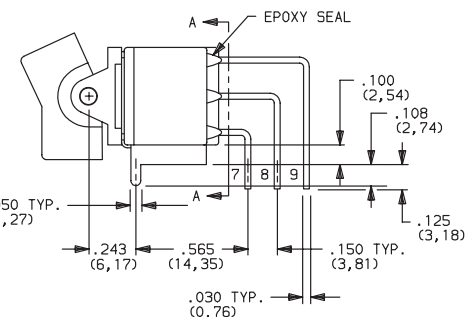

AV3 VERTICAL RIGHT ANGLE, SNAP-IN, PC THRU-HOLE,
.150" PITCH

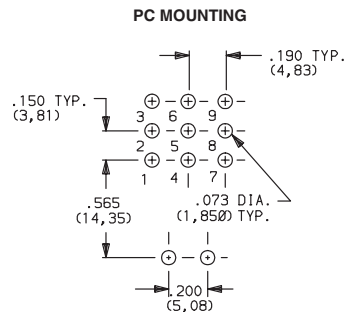
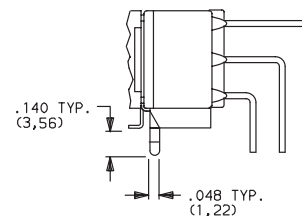
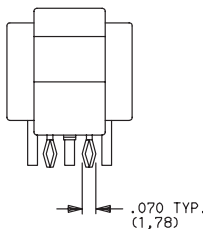

NOTE: Terminal bend radii and lead-in manufacturing option.
Available actuators, see pages H-28 and H-30.



Dimensions are shown: Inch (mm)
Specifications and dimensions subject to change

Rocker



H

C&K E Series Sealed Miniature Rocker and Lever Handle Switches

TERMINATIONS

V5 VERTICAL RIGHT ANGLE, PC THRU-HOLE,
.150" PITCH

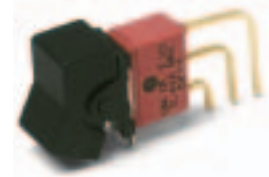
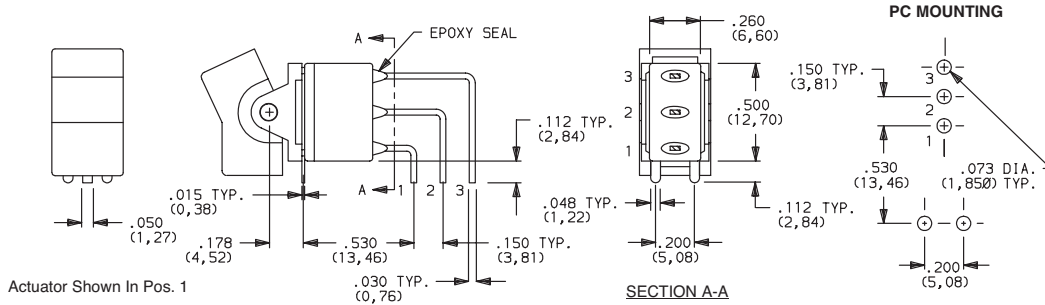

E101J1V5BE2
Vertical Actuation
SPDT

NOTE: Terminal bend radii and lead-in manufacturing option.
Available actuators, see pages H-28 and H-30.

V5 VERTICAL RIGHT ANGLE, PC THRU-HOLE,
.150" PITCH

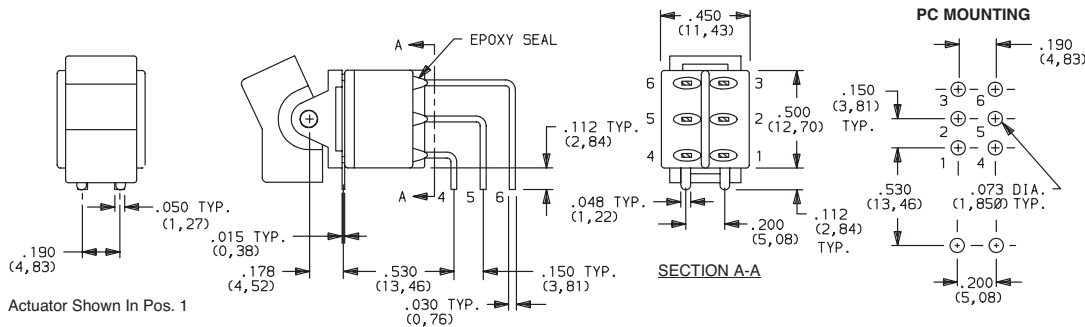

E201J1V5BE2
Vertical Actuation
DPDT

NOTE: Terminal bend radii and lead-in manufacturing option.
Available actuators, see pages H-28 and H-30.

Rocker



H



Third Angle
Projection
Dimensions are shown: Inch (mm)
Specifications and dimensions subject to change

C&K E Series Sealed Miniature Rocker and Lever Handle Switches

TERMINATIONS

V6, V7, V8 VERTICAL MOUNT, V-BRACKET

V21 VERTICAL MOUNT, V-BRACKET, SNAP-IN



E101J1_BE2
SPDT

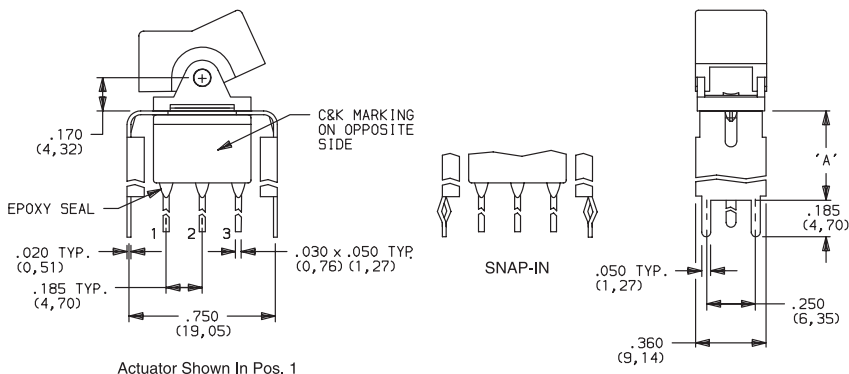

PC MOUNTING

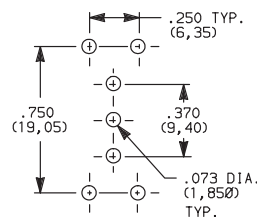

OPTION CODE	DIM 'A'
V21	.555 (14, 10Y)
V6	.460 (11, 68Y)
V7	.630 (16, 00Y)
V8	.953 (24, 21Y)

NOTE: Available actuators, see pages H-28 and H-30.

V6, V7, V8 VERTICAL MOUNT, V-BRACKET

V21 VERTICAL MOUNT, V-BRACKET, SNAP-IN



E201J1_BE2
DPDT

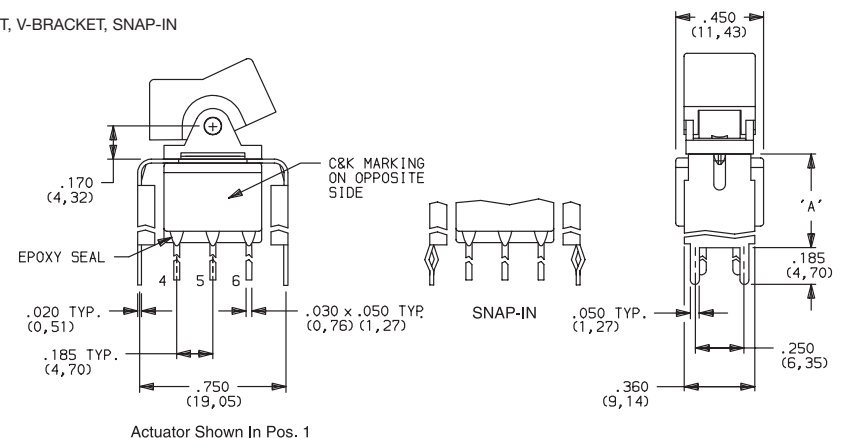

PC MOUNTING

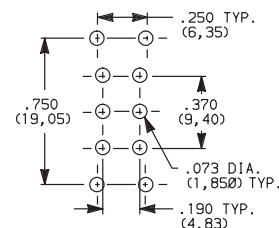

OPTION CODE	DIM 'A'
V21	.555 (14, 10Y)
V6	.460 (11, 68Y)
V7	.630 (16, 00Y)
V8	.953 (24, 21Y)

NOTE: Available actuators, see pages H-28 and H-30.

V7, V8 VERTICAL MOUNT, V-BRACKET

V21 VERTICAL MOUNT, V-BRACKET, SNAP-IN



E301J1_BE2
3PDT

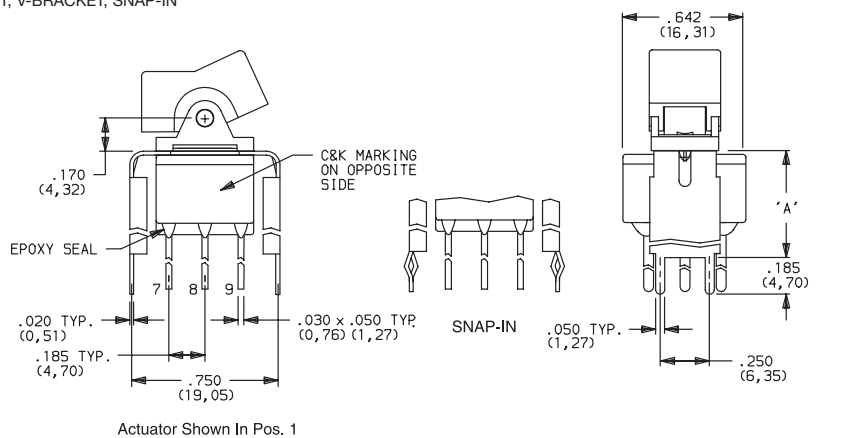

PC MOUNTING

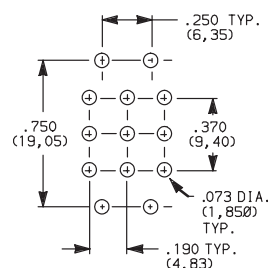

OPTION CODE	DIM 'A'
V21	.555 (14, 10Y)
V7	.630 (16, 00Y)
V8	.953 (24, 21Y)

NOTE: Available actuators, see pages H-28 and H-30.

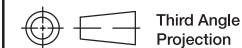

Third Angle Projection
Dimensions are shown: Inch (mm)
Specifications and dimensions subject to change

Rocker



H

C&K E Series Sealed Miniature Rocker and Lever Handle Switches

TERMINATIONS

V3, V4 VERTICAL MOUNT, V-BRACKET

V31 VERTICAL MOUNT, V-BRACKET, SNAP-IN

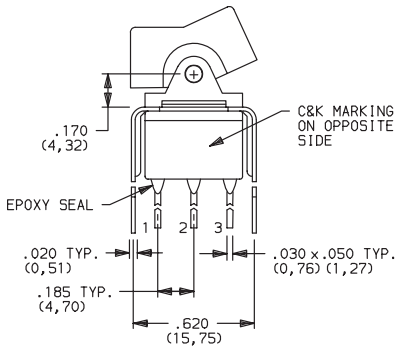

Actuator Shown In Pos. 1

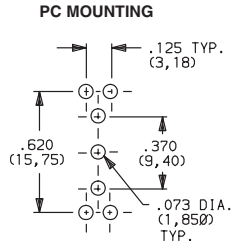
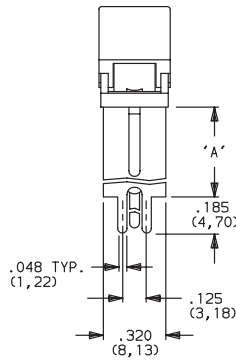
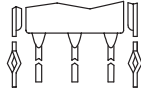

E101J1_BE2
SPDT

OPTION CODE	DIM 'A'
V3, V31	.460 (11,68Y)
V4	.630 (16,00Y)

NOTE: Available actuators, see pages H-28 and H-30.

V3, V4 VERTICAL MOUNT, V-BRACKET

V31 VERTICAL MOUNT, V-BRACKET, SNAP-IN

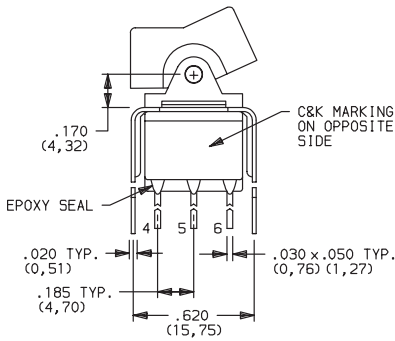

Actuator Shown In Pos. 1

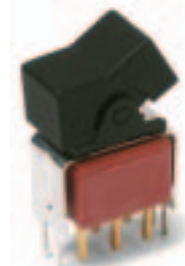
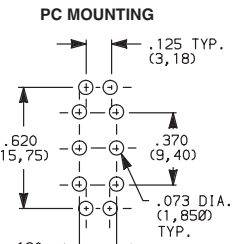
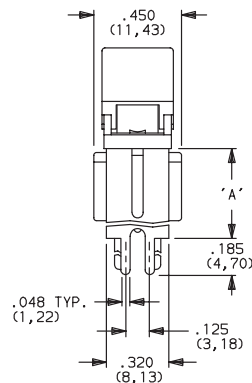
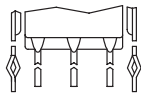

E201J1_BE2
DPDT

OPTION CODE	DIM 'A'
V3, V31	.460 (11,68Y)
V4	.630 (16,00Y)

NOTE: Available actuators, see pages H-28 and H-30.

V4 VERTICAL MOUNT, V-BRACKET

VERTICAL MOUNT, V-BRACKET, SNAP-IN

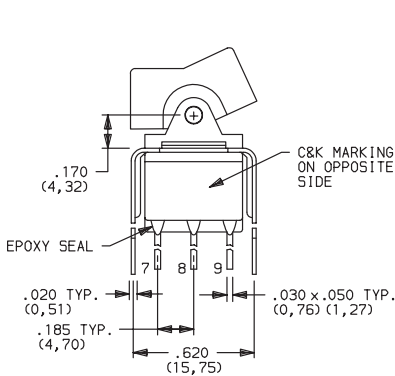

Actuator Shown In Pos. 1

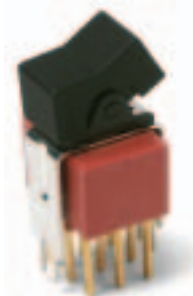
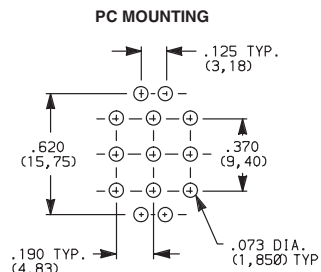
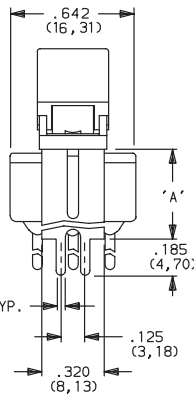
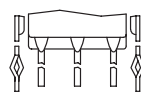

E301J1_BE2
3PDT

OPTION CODE	DIM 'A'
V41	.630 (16,00Y)

NOTE: Available actuators, see pages H-28 and H-30.

Rocker



H



Third Angle Projection
Dimensions are shown: Inch (mm)
Specifications and dimensions subject to change

C&K E Series Sealed Miniature Rocker and Lever Handle Switches

CONTACT MATERIAL

OPTION CODE	RoHS COMPLIANT *	RoHS COMPATIBLE *	CONTACT MATERIAL	TERMINAL PLATING	RATINGS	
B	YES	YES	GOLD ¹	GOLD ¹	LOW LEVEL/ DRY CIRCUIT	0.4 VA MAX. @ 20 V AC OR DC MAX.
K	NO	YES		TIN-LEAD ⁶		
P	YES	YES		MATTE-TIN ⁷		
Q	YES	YES	SILVER ^{4,5}	SILVER ⁵	POWER	E1XX & E2XX MODELS: 7.5 AMPS @125 V AC OR 28 V DC; 3 AMPS @ 250 V AC. E3XX MODELS: 5 AMPS @ 125 V AC OR 28 V DC; 2 AMPS @ 250 V AC.
M	NO	YES		TIN-LEAD ⁶		
S	YES	YES		MATTE-TIN ⁷		
G	YES	YES	GOLD OVER SILVER ^{2,3}	GOLD ³	LOW LEVEL/DRY CIRCUIT OR POWER	E1XX AND E2XX MODELS: 0.4 VA MAX @20 V AC OR DC MAX. OR 7.5 AMPS @125 V AC OR 28 V DC; 3 AMPS @ 250 V AC. DC E3XX MODELS: 0.4 VA MAX. @ 20 V AC OR DC MAX. OR 5 AMPS @ 125 V AC OR 28 V DC; 2 AMPS @ 250 V AC.
L	NO	YES		TIN-LEAD ⁶		
R	YES	YES		MATTE-TIN ⁷		

* Note: See Technical Data section of this catalog for RoHS compliant and compatible definitions and specifications.

¹ CONTACTS & TERMINALS: Copper alloy, with gold plate over nickel plate.

² END CONTACTS: Coin silver, with gold plate over nickel plate.

³ CENTER CONTACTS & ALL TERMINALS: Copper alloy, with gold plate over nickel plate.

⁴ END CONTACTS: Coin silver, silver plated.

⁵ CENTER CONTACT & ALL TERMINALS: Copper alloy, with gold flash over silver plate. Or copper alloy, silver plated.

⁶ TERMINALS: Copper alloy, with tin-lead alloy over nickel plate.

⁷ TERMINALS: Copper alloy, with matte-tin over nickel plate.

NOTE: Any models supplied with Q, B, G, S P & R contact material are RoHS compliant. For the latest information regarding RoHS compliance, please go to: www.ittcannon.com/rohs.

All models  with all options when ordered with G, L, M, Q, S & R contact material. B contact material standard with all terminations.

K, L, M, P R & S contact materials not available with Z terminations.

SEAL

E EPOXY SEAL

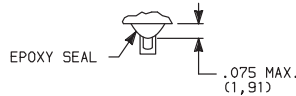

AVAILABLE HARDWARE

J2, J21 Actuators



PART NO.
760502263 BLACK
760503000 RED
Material: Nylon
Finish: Matte

J3 Actuator



PART NO.
766602263 BLACK
766603000 RED
Material: Nylon
Finish: Matte

J1, J11 Actuators



PART NO.
776A02263 BLACK
776A03000 RED
Material: Nylon
Finish: Matte

J50 Actuator



PART NO.
775A02263 BLACK
775A03000 RED
Material: Nylon
Finish: Matte

J60 Actuator



PART NO.
613802263 BLACK
598103000 RED
Material: Nylon
Finish: Matte

J90 Actuator



PART NO.
598002263 BLACK
598003000 RED
Material: Nylon
Finish: Matte



NOTE: Additional nuts, screws and lockwashers available separately, see Technical Data section of this catalog. Other colors available, consult Customer Service Center.



Third Angle Projection

Dimensions are shown: Inch (mm)
Specifications and dimensions subject to change

Rocker



H

C&K E Series Sealed Miniature Rocker and Lever Handle Switches

AVAILABLE HARDWARE

Fits Z3 Termination female connector



PART NO.
530100000

Available in loose pieces.

Frame for J11, J21 Actuators



PART NO.
764500746 BLACK ENAMEL
764601106 RETAINING SPRING
Material: Spring Steel

J50, J60 & J90 Actuators

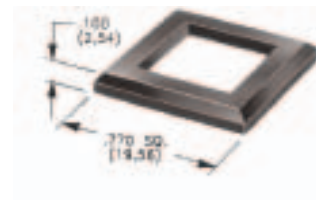

MATTE	GLOSS
PART NO.	PART NO.
486702000	486802000 BLACK
Material: Nylon	
Finish: Matte or Gloss	

NOTE: Additional nuts, screws and lockwashers available separately, see Technical Data section of this catalog. Other colors available, consult Customer Service Center.

Frames snap into panel opening and are independent from switch mounting. Accurate positioning of the PC mounted switch relative to the panel opening is necessary to provide proper clearance between actuator and frame. Available in two basic styles and four panel thicknesses .047-.125 in. Material: Nylon. Finish: Matte.

TYPICAL APPLICATION

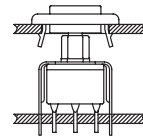

J1 & J2 Actuators

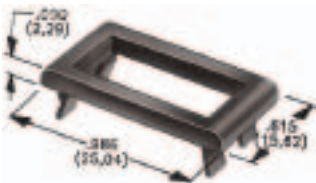

.047" (1,19YPANEL THK.)	.062" (1,57YPANEL THK.)	.090" (2,29YPANEL THK.)	.125" (3,18YPANEL THK.)
PART NO.	PART NO.	PART NO.	PART NO.
452902263	452702263	452802263	452602263 BLACK
452903000	452703000	452803000	452603000 RED

J50, J60 & J90 Actuators

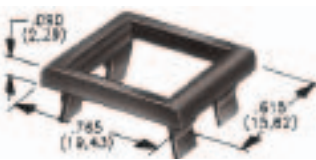

.047" (1,19YPANEL THK.)	.062" (1,57YPANEL THK.)	.090" (2,29YPANEL THK.)	.125" (3,18YPANEL THK.)
PART NO.	PART NO.	PART NO.	PART NO.
432502263	432602263	432702263	432802263 BLACK
432503000	432603000	432703000	432803000 RED

PANEL MOUNTING

For part numbers
4529xxxxx, 4527xxxxx,
4528xxxxx, 4526xxxxx

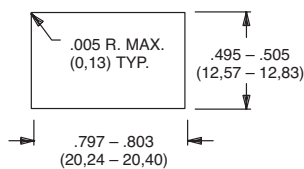

For part numbers
4325xxxxx, 4326xxxxx

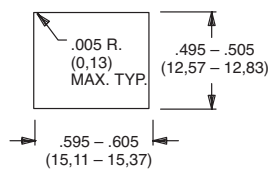

For part numbers
4327xxxxx, 4328xxxxx

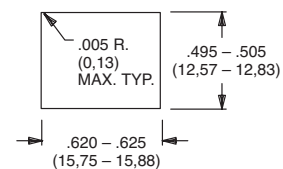

Rocker



H



Third Angle Projection

Dimensions are shown: Inch (mm)
Specifications and dimensions subject to change

C&K E Series Sealed Miniature Rocker and Lever Handle Switches

AVAILABLE HARDWARE

Panel Inserts

Will fit separate snap-in frames for J50, J60, J90 actuators.

Above frames (part nos. 432XXXXXX) are also available with insert which accepts LED for indicator light assembly. Order insert separately from frame. Blank insert panel (without hole for LED) also available. **LED not included.**

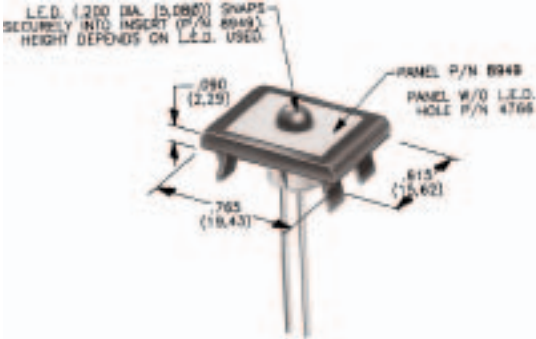

PANEL INSERT WITH HOLE FOR LED

BLANK PANEL INSERT WITHOUT HOLE FOR LED

PART NO.

894902000
894903000

PART NO.

476602000 BLACK
476603000 RED

Special colors, custom markings available, consult Customer Service Center.

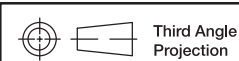

Dimensions are shown: Inch (mm)
Specifications and dimensions subject to change

