



ATTENTION
OBSERVE PRECAUTIONS
FOR HANDLING
ELECTROSTATIC
DISCHARGE
SENSITIVE
DEVICES

P/N: DA56-51PBWA/A

BLUE

PRELIMINARY SPEC

Features

- 0.56 INCH DIGIT HEIGHT.
- LOW CURRENT OPERATION.
- EXCELLENT CHARACTER APPEARANCE.
- EASY MOUNTING ON P.C. BOARDS OR SOCKETS.
- TWO DIGIT PACKAGE SIMPLIFIES ALIGNMENTS & ASSEMBLY.
- I.C. COMPATIBLE.
- MECHANICALLY RUGGED.
- STANDARD : GRAY FACE, WHITE SEGMENT.
- RoHS COMPLIANT.

Description

The Blue source color devices are made with InGaN on SiC Light Emitting Diode.
Static electricity and surge damage the LEDs.
It is recommended to use a wrist band or anti-electrostatic glove when handling the LEDs.
All devices, equipment and machinery must be electrically grounded.

Package Dimensions & Internal Circuit Diagram

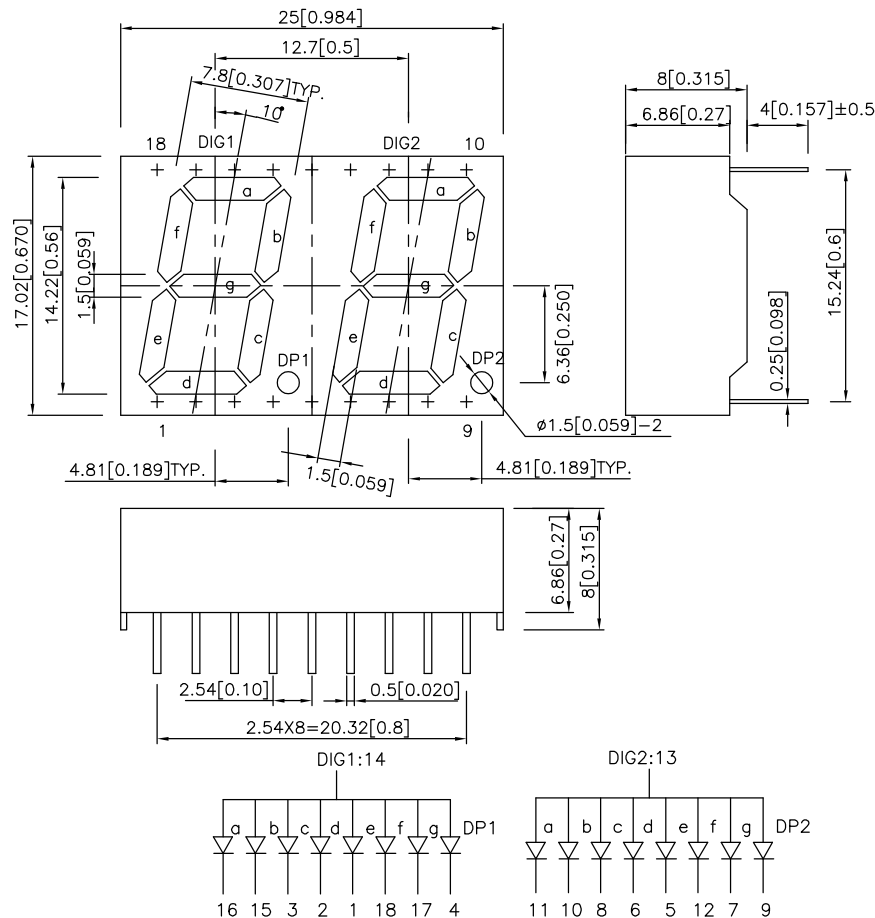

Notes:

1. All dimensions are in millimeters (inches), Tolerance is $\pm 0.25(0.01)$ unless otherwise noted.
2. Specifications are subject to change without notice.

Selection Guide

Part No.	Dice	Lens Type	Iv (ucd) [1] @ 10mA		Description
			Min.	Typ.	
DA56-51PBWA/A	BLUE (InGaN)	WHITE DIFFUSED	1900	8500	Common Anode, Rt. Hand Decimal

Note:

1. Luminous Intensity/ Luminous Flux: +/-15%.

Electrical / Optical Characteristics at TA=25°C

Symbol	Parameter	Device	Typ.	Max.	Units	Test Conditions
λ_{peak}	Peak Wavelength	Blue	468		nm	IF=20mA
λ_D [1]	Dominant Wavelength	Blue	470		nm	IF=20mA
$\Delta\lambda_{1/2}$	Spectral Line Half-width	Blue	21		nm	IF=20mA
C	Capacitance	Blue	100		pF	VF=0V;f=1MHz
VF [2]	Forward Voltage	Blue	3.3	3.8	V	IF=20mA
IR	Reverse Current	Blue		10	uA	VR = 5V

Notes:

1. Wavelength: +/-1nm.

2. Forward Voltage: +/-0.1V.

Absolute Maximum Ratings at TA=25°C

Parameter	Blue	Units
Power dissipation	114	mW
DC Forward Current	30	mA
Peak Forward Current [1]	100	mA
Reverse Voltage	5	V
Operating/Storage Temperature	-40°C To +85°C	
Lead Solder Temperature [2]	260°C For 5 Seconds	

Notes:

1. 1/10 Duty Cycle, 0.1ms Pulse Width.

2. 2mm below package base.

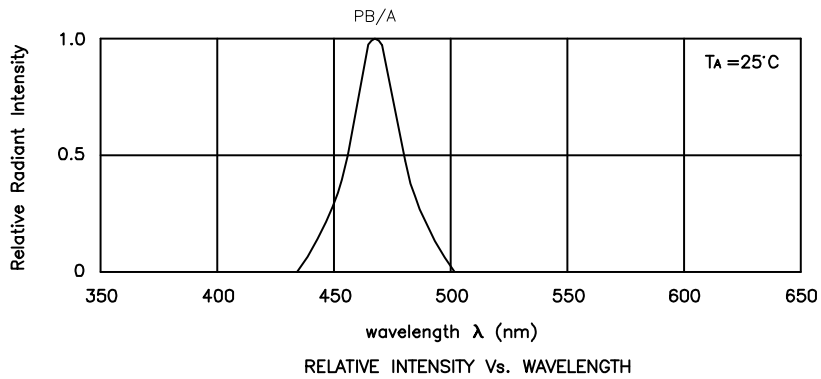

Blue

DA56-51PBWA/A

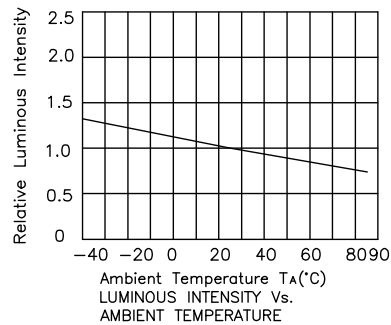
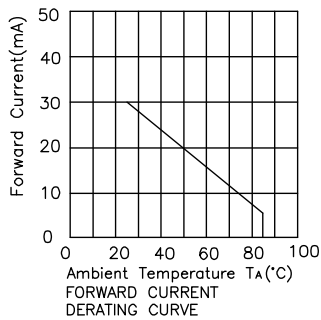
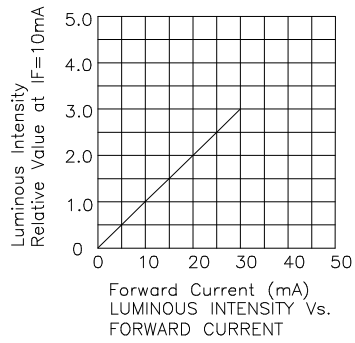
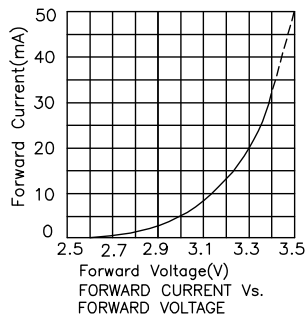

PACKING & LABEL SPECIFICATIONS

DA56-51PBWA/A

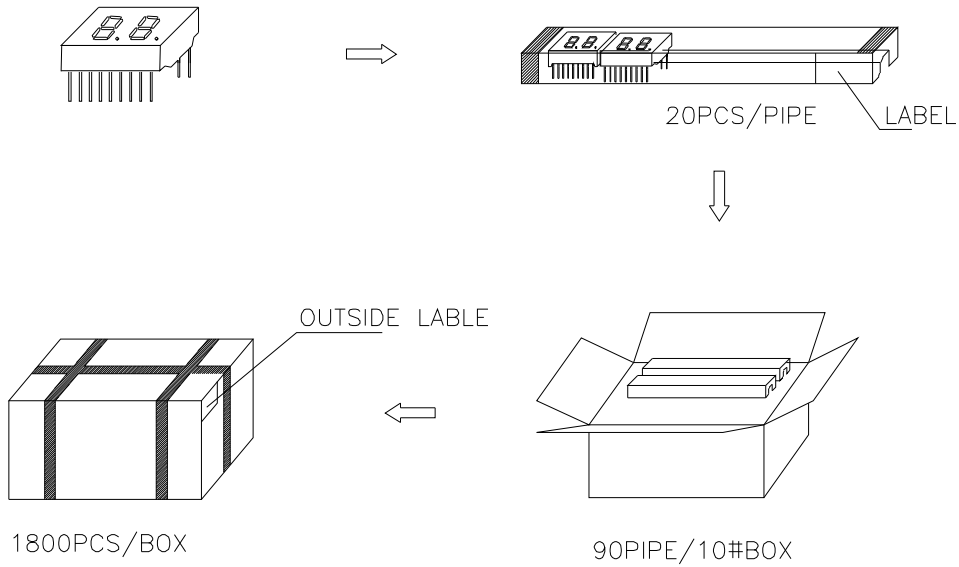

Inside LABEL Paste On The IC-pipe

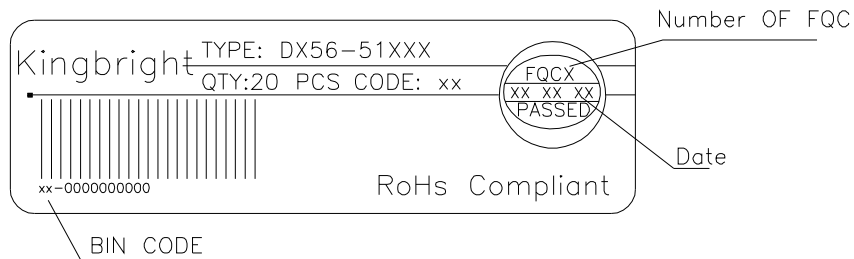

Outside LABEL Paste On The Box

