

# Thick Film, Rectangular Chip Resistors



## FEATURES

- Metal glaze on high quality ceramic
- Protective overglaze
- Solder contacts on Ni barrier layer
- Excellent stability in different environmental conditions
- High volume product suitable for commercial and special applications

STANDARD ELECTRICAL SPECIFICATIONS								
MODEL	SIZE		POWER RATING P <sub>70°C</sub> W	LIMITING ELEMENT VOLTAGE MAX V <sub>≡</sub>	TEMPERATURE COEFFICIENT ppm/K	TOLERANCE %	RESISTANCE RANGE Ω	E-SERIES
	INCH	METRIC	CECC 40401-802/EIA-575					
CRCW0201	0201	0525	0.05	30	± 200	± 1 ± 5	10R – 1M0 10R – 1M0	24 + 96 24
			Zero-Ohm-Resistor: R <sub>max</sub> = 50mΩ, I <sub>max</sub> = 1A					
D10 CRCW0402	0402	1005	0.063	50	± 200 <sup>1)</sup> ± 100 ± 200	± 1 ± 1 ± 5	1R0 – 9R76 10R – 10M 1R0 – 10M	24 + 96 24 + 96 24
			Zero-Ohm-Resistor: R <sub>max</sub> = 20mΩ, I <sub>max</sub> = 1A					
D11 CRCW0603	0603	1608	0.10	75	± 200 <sup>1)</sup> ± 100 ± 200	± 1 ± 1 ± 5	1R0 – 9R76 10R – 10M 1R0 – 10M	24 + 96 24 + 96 24
			Zero-Ohm-Resistor: R <sub>max</sub> = 20mΩ, I <sub>max</sub> = 1.5A					
D12 CRCW0805	0805	2012	0.125	150	± 200 <sup>1)</sup> ± 100 ± 200	± 1 ± 1 ± 5	1R0 – 9R76 10R – 10M 1R0 – 10M	24 + 96 24 + 96 24
			Zero-Ohm-Resistor: R <sub>max</sub> = 20mΩ, I <sub>max</sub> = 2A					
D25 CRCW1206	1206	3216	0.25	200	± 200 <sup>1)</sup> ± 100 ± 200	± 1 ± 1 ± 5	1R0 – 9R76 10R – 10M 1R0 – 10M	24 + 96 24 + 96 24
			Zero-Ohm-Resistor: R <sub>max</sub> = 20mΩ, I <sub>max</sub> = 2.5A					
CRCW1210	1210	3225	0.33	200	± 200 <sup>1)</sup> ± 100 ± 200	± 1 ± 1 ± 5	1R0 – 9R76 10R – 1M0 1R0 – 10M	24 + 96 24 + 96 24
			Zero-Ohm-Resistor: R <sub>max</sub> = 20mΩ, I <sub>max</sub> = 2.5A					
CRCW1218	1218	3246	1.0	200	± 200 <sup>1)</sup> ± 100 ± 200	± 1 ± 1 ± 5	1R0 – 9R76 10R – 2M2 1R0 – 2M2	24 + 96 24 + 96 24
			Zero-Ohm-Resistor: R <sub>max</sub> = 20mΩ, I <sub>max</sub> = 4A					
CRCW2010	2010	5025	0.5	400	± 200 <sup>1)</sup> ± 100 ± 200	± 1 ± 1 ± 5	1R0 – 9R76 10R – 10M 1R0 – 10M	24 + 96 24 + 96 24
			Zero-Ohm-Resistor: R <sub>max</sub> = 20mΩ, I <sub>max</sub> = 3A					
CRCW2512	2512	6332	1.0	500	± 200 <sup>1)</sup> ± 100 ± 200	± 1 ± 1 ± 5	1R0 – 9R76 10R – 10M 1R0 – 10M	24 + 96 24 + 96 24
			Zero-Ohm-Resistor: R <sub>max</sub> = 20mΩ, I <sub>max</sub> = 4A					

- 1) 100ppm/K on request
- Ask about further value ranges
- For low values see Thick Film rectangular low value resistors
- For high values see Thick Film rectangular high values.
- Marking and packaging: see appropriate catalog or web pages
- For precision Thick Film CRCW see Thick Film rectangular Precision Resistors
- Power rating depends on the max. temperature at the solder point, the component placement density and the substrate material
- AgPd or Pd terminations for conductive adhesive attachment on request

TECHNICAL SPECIFICATIONS										
PARAMETER	UNIT	CRCW021	D10 CRCW0402	D11 CRCW0603	D12 CRCW0805	D25 CRCW1206	CRCW1210	CRCW1218	CRCW2010	CRCW2512
Rated Dissipation at 70°C (CECC 40401   EIA 575)	W	0.05	0.063	0.10	0.125	0.25	0.33	1.0	0.5	1.0
Limiting Element Voltage <sup>2)</sup>	V <sub>≡</sub>	30	50	75	150	200	200	200	400	500
Insulation Voltage (1 min)	V <sub>peak</sub>	50	> 75	> 100	> 200	> 300	> 300	> 300	> 300	> 300
Thermal Resistance	K/W		≤ 870 <sup>1)</sup>	≤ 550 <sup>1)</sup>	≤ 440 <sup>1)</sup>	≤ 220 <sup>1)</sup>	≤ 140 <sup>3)</sup>	<sup>3)</sup>	≤ 88 <sup>3)</sup>	≤ 65 <sup>3)</sup>
Insulation Resistance	Ω	> 10 9								
Category Temperature Range	°C	- 55 to + 125 (+ 155)								
Failure Rate	h <sup>-1</sup>	1.10 <sup>-9</sup>	0.3 • 10 <sup>-9</sup>							
Weight / 1000pcs	g	0.17	0.65	2	5.5	10	16	29.5	25.5	40.5

<sup>1)</sup> Measuring conditions in acc. to CECC 4040 <sup>3)</sup> Depending on solder pad dimensions  
<sup>2)</sup> Rated voltage:  $\sqrt{P \times R}$



**DIMENSIONS**

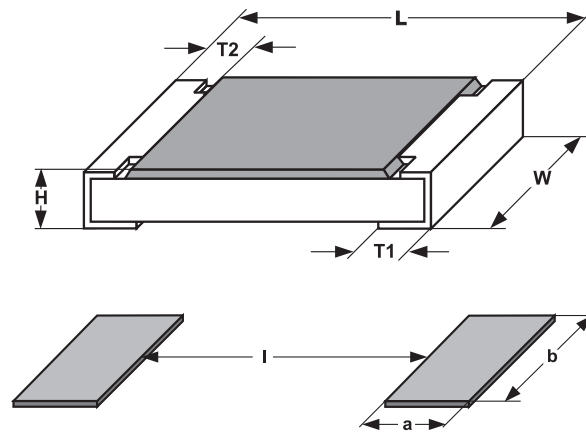

SIZE		DIMENSIONS [in millimeters]				
INCH	METRIC	L	W	H	T1	T2
0201	0525	0.6 ± 0.05	0.3 ± 0.05	0.23 ± 0.05	0.15 ± 0.05	0.6 ± 0.05
0402	1005	1.0 ± 0.05	0.5 ± 0.05	0.35 ± 0.05	0.25 ± 0.05	0.2 ± 0.1
0603	1608	1.55 <sup>+0.10</sup> <sub>-0.05</sub>	0.85 ± 0.1	0.45 ± 0.05	0.3 ± 0.2	0.3 ± 0.2
0805	2012	2.0 <sup>+0.20</sup> <sub>-0.10</sub>	1.25 ± 0.15	0.45 ± 0.05	0.3 <sup>+0.20</sup> <sub>-0.10</sub>	0.3 ± 0.2
1206	3216	3.2 <sup>+0.10</sup> <sub>-0.20</sub>	1.6 ± 0.15	0.55 ± 0.05	0.45 ± 0.2	0.4 ± 0.2
1210	3225	3.2 ± 0.2	2.5 ± 0.2	0.55 ± 0.05	0.45 ± 0.2	0.4 ± 0.2
1218	3246	3.2 <sup>+0.10</sup> <sub>-0.20</sub>	4.6 ± 0.15	0.55 ± 0.05	0.45 ± 0.2	0.4 ± 0.2
2010	5025	5.0 ± 0.15	2.5 ± 0.15	0.6 ± 0.05	0.6 ± 0.2	0.6 ± 0.2
2512	6332	6.3 ± 0.2	3.15 ± 0.15	0.6 ± 0.05	0.6 ± 0.2	0.6 ± 0.2

SIZE		SOLDER PAD DIMENSIONS [in millimeters]					
INCH	METRIC	REFLOW SOLDERING			WAVE SOLDERING		
		a	b	l	a	b	l
0201	0525	0.28	0.43	0.23			
0402	1005	0.4	0.6	0.5			
0603	1608	0.5	0.9	1.0	0.9	0.9	1.0
0805	2012	0.7	1.3	1.2	0.9	1.3	1.3
1206	3216	0.9	1.7	2.0	1.1	1.7	2.3
1210	3225	0.9	2.5	2.0	1.1	2.5	2.2
1218	3246	1.05	4.9	1.9	1.25	4.8	1.9
2010	5025	1.0	2.5	3.9	1.2	2.5	3.9
2512	6332	1.0	3.2	5.2	1.2	3.2	5.2

**PART NUMBER AND PRODUCT DESCRIPTION**

PART NUMBER: D1208050A5620JP0

D 1 2 0 8 0 5 0 A 5 6 2 0 J P 0

MODEL/SIZE	SPECIAL CHARACTER	T.C.	VALUE	TOLERANCE	PACKING	SPECIAL
D100402 D110603 D120805 D251206	0 = neutral	B = ± 100 ppm/K A = ± 200 ppm/K 0 = Jumper	3 digit value 1 digit multiplier  MULTIPLIER 7 = *10 <sup>-3</sup> 2 = *10 <sup>2</sup> 8 = *10 <sup>-2</sup> 3 = *10 <sup>3</sup> 9 = *10 <sup>-1</sup> 4 = *10 <sup>4</sup> 0 = *10 <sup>0</sup> 5 = *10 <sup>5</sup> 1 = *10 <sup>1</sup> 6 = *10 <sup>6</sup> 0000 = Jumper	F = ± 1 % J = ± 5 %	P0 M0 P5 PZ PN B5 MZ BN MU	up to 2 digits
<b>PRODUCT DESCRIPTION: D12 200 562R 5% P5</b>						
D12	200	562R	5 %	P5		
MODEL	TC	RESISTANCE VALUE	TOLERANCE	PACKING <sup>1)</sup>		
D10 D11 D12 D25	± 100 ppm/K ± 200 ppm/K	49K9 = 49.9KΩ 5R1 = 5.1Ω 0R0 = Jumper	± 1 % ± 5 %	P0 M0 P5 PZ PN B5 MZ BN MU		

PART NUMBER: CRCW0805562RJNTA

C R C W 0 8 0 5 5 6 2 R J N T A

MODEL/SIZE	VALUE	TOLERANCE	T.C.	PACKING	SPECIAL
CRCW0201 CRCW0402 CRCW0603 CRCW0805 CRCW1206 CRCW1210 CRCW2512 CRCW2010 CRCW2512	R = Decimal K = Thousand M = Million 0000 = Jumper	F = ± 1 % J = ± 5 % Z = Zero Ohm Jumper	K = ± 100 ppm/K N = ± 200 ppm/K S = Jumper or Special	TA = RT1 TB = RT5 TC = RT6 TD = RT7 TF = R02 TG = R67 TH = R82 TK = RT9 BA = B27	up to 2 digits TR = Customer Trimmable
<b>PRODUCT DESCRIPTION: CRCW 0805 5620 J 100 RT1</b>					
CRCW	0805	5620	J	200	RT1
MODEL	SIZE	RESISTANCE VALUE	TOLERANCE	T.C.	PACKING <sup>1)</sup>
CRCW	0201 1201 0402 1218 0603 2010 0805 2512 1206	685 = 6.8MΩ 224 = 220KΩ	F = ± 1 % J = ± 5 % Z = Zero Ohm Jumper	± 100 ppm/K ± 200 ppm/K	RT1 R67 RT5 R82 RT6 RT9 RT7 B27 R02
± 1 % = 3 sig.digits, plus multiplier ± 5 % = 2 sig.digits, plus multiplier					

NOTE: 1) Please refer to table PACKING, page 3.

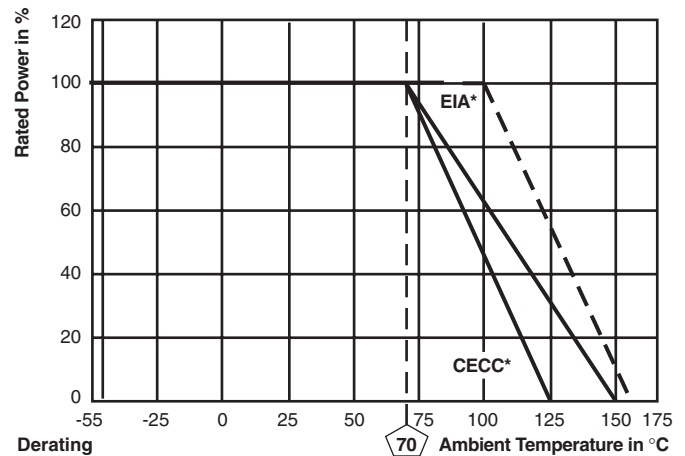
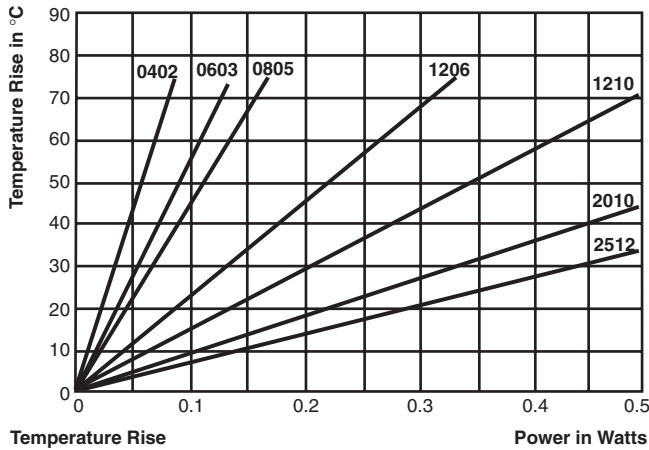

\*There are differences in board layout and measurements between CECC and EIA.

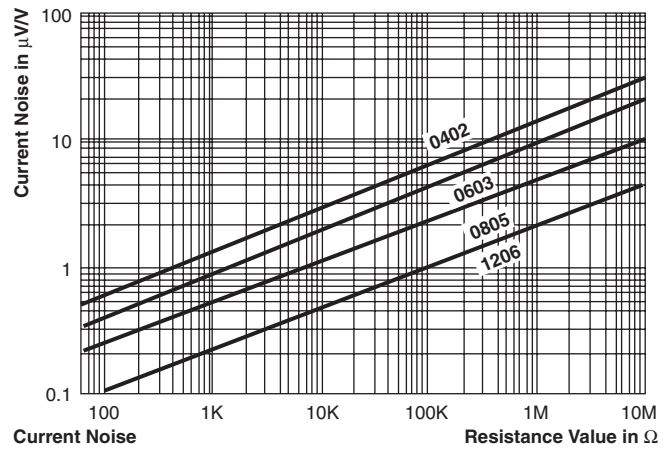
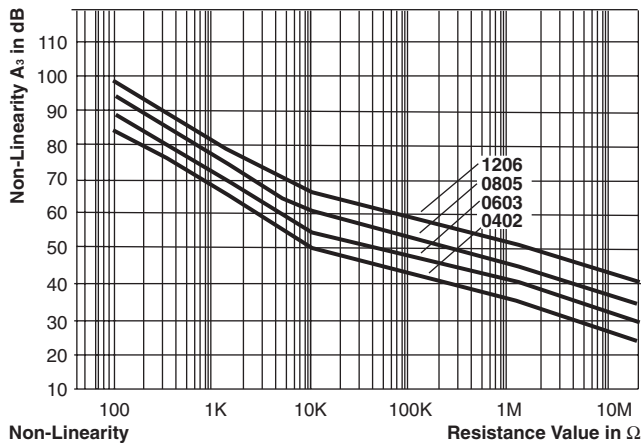

PACKING								
MODEL	REEL				BULK			
	TAPE WIDTH	DIAMETER	PIECES/REEL	PITCH	PACKING CODE		BULK FEEDING MAGAZINE PIECES/MAGAZINE	
					PAPER <sup>1)</sup>	BLISTER <sup>2)</sup>	PIECES <sup>1)</sup>	CODE <sup>2)</sup>
D10 CRCW0402	8mm	180mm/7"	10 000	2mm	P0/RT7		50000	MZ/B27
		330mm/13"	50 000	2mm	PZ/RF4			
D11 CRCW0603	8mm	180mm/7"	5 000	4mm	P5/RT1	B5/na	25000	MU/B27
		255mm/10"	10 000	4mm	P0/RT5			
		330mm/13"	20 000	4mm	PN/RT6	BN/na		
D12 CRCW0805	8mm	180mm/7"	5 000	4mm	P5/RT1	B5/na	10000	MO/B27
		255mm/10"	10 000	4mm	P0/RT5			
		330mm/13"	20 000	4mm	PN/RT6	BN/na		
D25 CRCW1206	8mm	180mm/7"	5 000	4mm	P5/RT1	B5/na		
		255mm/10"	10 000	4mm	P0/RT5			
		330mm/13"	20 000	4mm	PN/RT6	BN/na		
CRCW1210	8mm	180mm/7"	5 000	4mm	P5/RT1	B5/na		
		330mm/13"	20 000	4mm	PN/RT6	BN/na		
CRCW1218	12mm	180mm/7"	4 000	4mm		RT9		
CRCW2010	12mm	180mm/7"	4 000	4mm		R02		
CRCW2512	12mm	180mm/7"	2 000	8mm		B2/R67		
			4 000	4mm		R82		

1) On request

2) European/N.American packaging codes: na = NOT AVAILABLE • Further information about packaging: see appropriate catalog or web page.

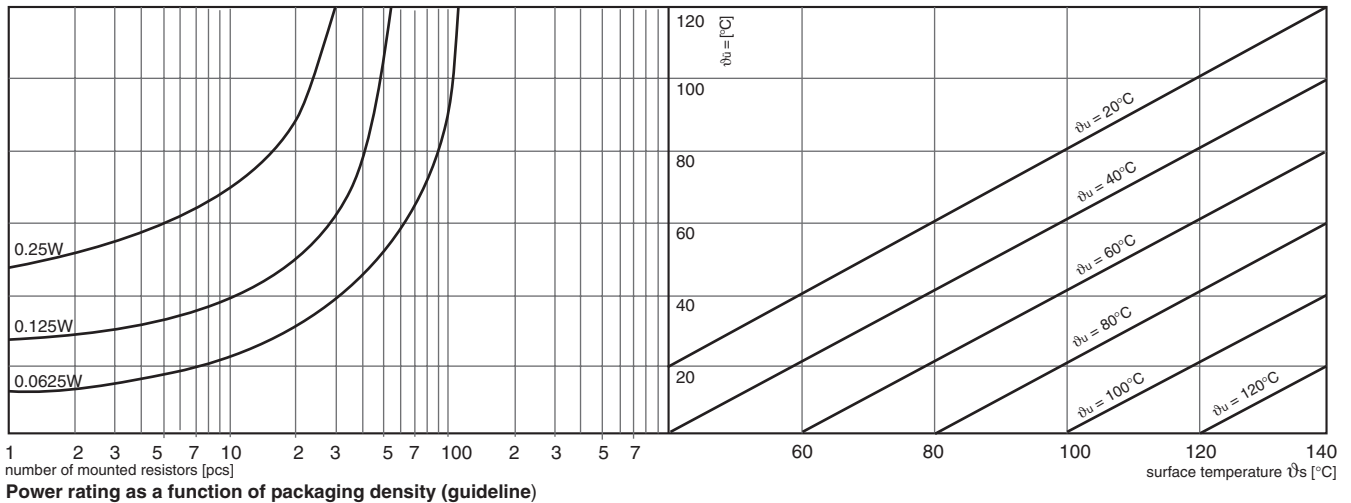
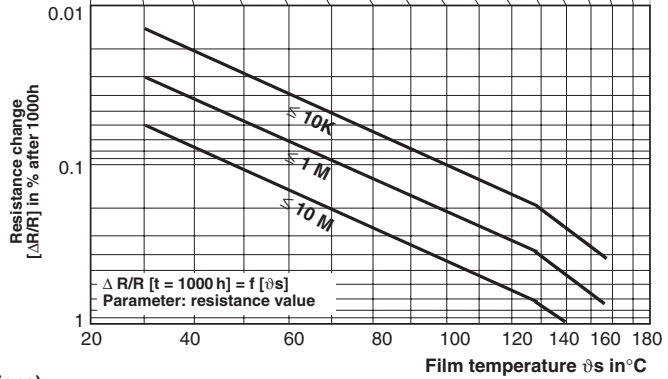
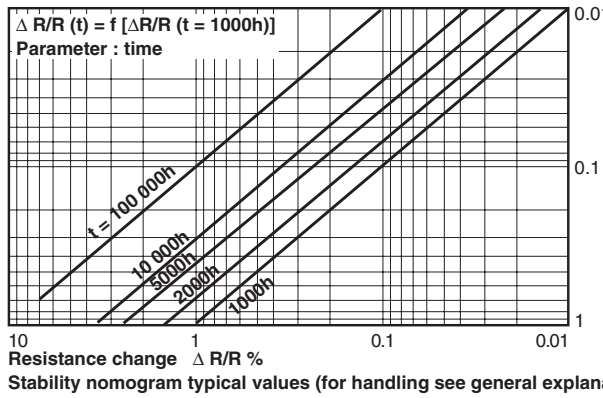
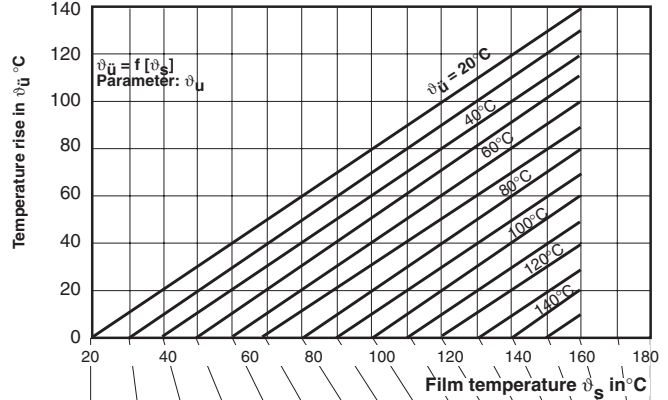
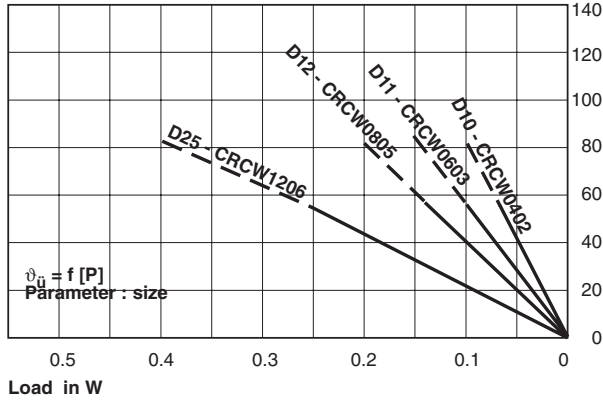

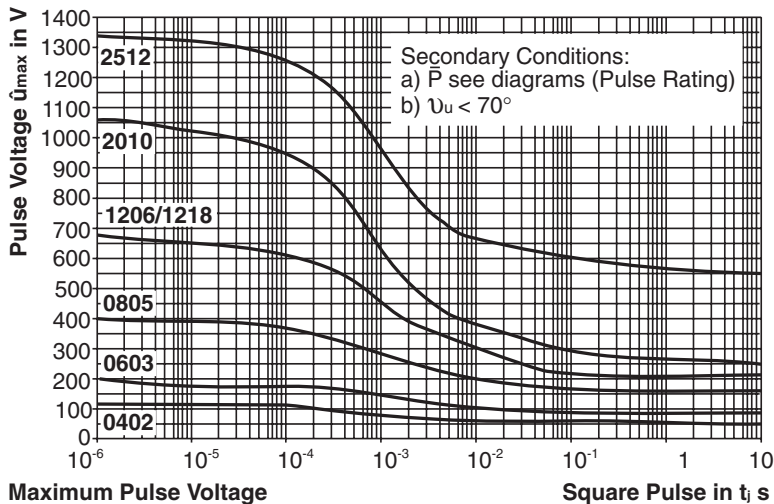
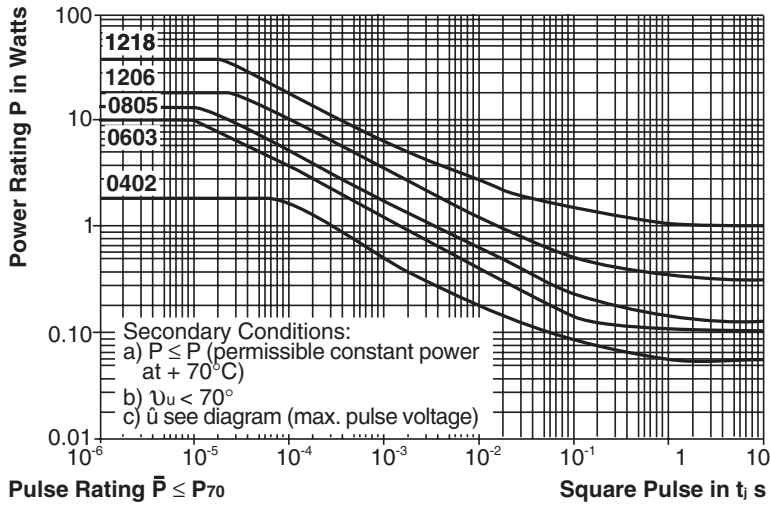
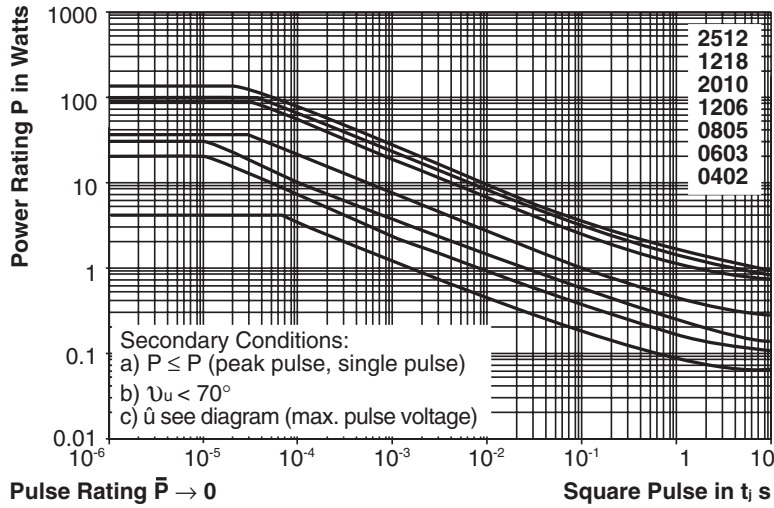



<b>PERFORMANCE</b>					
TEST	CONDITIONS OF TEST	REQUIREMENTS IN % <sup>1)</sup>			
		0402 0603	0805 1206 1210	1218 2010 2512	0201
Endurance Test at 70°C IEC 60115-1 4.25.1; EIA-575	1000 hours at 70°C, 1.5 hours "ON", 0.5 hours "OFF"	≤ ± 1.0	≤ ± 0.5	≤ ± 1.0	≤ ± 3.0
Endurance at UCT IEC 60115-1 4.25.3	1000 hours at 125°C without load	≤ ± 1.0	≤ ± 0.5	≤ ± 1.0	≤ ± 2.0
Overload Test IEC 60115-1 4.13; EIA-575	Short time overload, 2.5 x rated voltage or 2 x limiting element voltage.	≤ ± 0.25	≤ ± 0.25	≤ ± 0.5	≤ ± 1.0
Thermal Shock IEC 60115-1 4.19; IEC 60068-2-14; EIA-575	Rapid change between upper and lower category temperature	≤ ± 0.25	≤ ± 0.25	≤ ± 0.5	≤ ± 0.5
Damp Heat Steady State IEC 60115-1 4.24; IEC 60068-2-3	56 days at 40°C and 93% relative humidity	≤ ± 1.0	≤ ± 0.5	≤ ± 1.0	≤ ± 2.0
Resistance to Soldering Heat IEC 60115-1 4.18; IEC 60068-2-20; EIA-575	10 seconds at 260°C solder bath temperature	≤ ± 0.25	≤ ± 0.25	≤ ± 0.5	≤ ± 1.0

<sup>1)</sup> Limits for change of resistance at test acc. to CECC

<b>APPLICABLE SPECIFICATIONS</b>
<ul style="list-style-type: none"><li>• CECC40000/40400/40401-004,-006,-007,-802</li><li>• EN140400/IEC 60115-1</li><li>• EIA-575</li></ul>