

Cree® PLCC2 1 in 1 SMD LED CLM1B-BKW/GKW



PRODUCT DESCRIPTION

SMD LEDs is packaged in the industry standard package. These LEDs have high reliability performance and are designed to work under a wide range of environmental conditions.

This high reliability feature makes them ideally suited to be used under illumination application conditions.

Its wide viewing angle makes these LEDs ideally suited for channel letter, or general backlighting and illumination applications. The flat top emitting surface makes it easy for these LEDs to mate with light pipes.

FEATURES

- Size (mm): 3.2 x 2.7
- Color and Typical Dominant Wavelength:
Blue (470nm)
Green (527nm)
- Luminous Intensity (mcd)
CLM1B-BKW:
(280 - 710)
CLM1B-GKW:
(710 - 2240)
- Viewing angle: 120 degree
- Lead-Free
- RoHS Compliant

APPLICATIONS

- Light Strip
- Channel Letter
- Architectural Lighting

ABSOLUTE MAXIMUM RATINGS ($T_A = 25^\circ\text{C}$)

Items	Symbol	Absolute Maximum Rating	Unit
		BKW/GKW	
Forward Current	I_F	25	mA
Peak Forward Current ^{Note}	I_{FP}	100	mA
Reverse Voltage	V_R	5	V
Power Dissipation	P_D	100	mW
Operation Temperature	T_{opr}	-40 ~ +100	$^\circ\text{C}$
Storage Temperature	T_{stg}	-40 ~ +100	$^\circ\text{C}$
Junction Temperature	T_J	110	$^\circ\text{C}$
Junction/Ambient	R_{THJA}	450	$^\circ\text{C/W}$
Junction/Solder Point	R_{THJS}	300	$^\circ\text{C/W}$

Note: Pulse width ≤ 0.1 msec, duty $\leq 1/10$.

TYPICAL ELECTRICAL & OPTICAL CHARACTERISTICS ($T_A = 25^\circ\text{C}$)

Characteristics	Color	Symbol	Condition	Unit	Minimum	Typical	Maximum
Forward Voltage	BKW/GKW	V_F	$I_F = 20$ mA	V		3.2	4.0
Reverse Current	BKW/GKW	I_R	$V_R = 5$ V	μA			10
Dominant Wavelength	BKW	λ_D	$I_F = 20$ mA	nm	460	470	480
	GKW	λ_D	$I_F = 20$ mA	nm	520	527	540
Luminous Intensity	BKW	I_V	$I_F = 20$ mA	mcd	280	450	
	GKW	I_V	$I_F = 20$ mA	mcd	710	1300	
50% Power Angle	BKW/GKW	$2\theta_{1/2}$	$I_F = 20$ mA	deg		120	

INTENSITY BIN LIMIT ($I_f = 20 \text{ mA}$)

Blue (CLM1B-BKW)

Bin Code	Min.(mcd)	Max.(mcd)
Ta	280	355
Tb	355	450
Ua	450	560
Ub	560	710

Green (CLM1B-GKW)

Bin Code	Min.(mcd)	Max.(mcd)
Va	710	900
Vb	900	1120
Wa	1120	1400
Wb	1400	1800
Xa	1800	2240

Tolerance of measurement of luminous intensity is $\pm 10\%$.

COLOR BIN LIMIT ($I_f = 20 \text{ mA}$)

Blue (CLM1B-BKW)

Bin Code	Min.(nm)	Max.(nm)
B3	460	465
B4	465	470
B5	470	475
B6	475	480

Green (CLM1B-GKW)

Bin Code	Min.(nm)	Max.(nm)
G7	520	525
G8	525	530
G9	530	535
Ga	535	540

Tolerance of measurement of dominant wavelength is $\pm 1 \text{ nm}$.

ORDER CODE TABLE*

Color	Kit Number	Viewing Angle	Luminous Intensity (mcd)		Dominant Wavelength			
			Min.	Max.	Color Bin	Min. (nm)	Color Bin	Max. (nm)
Blue	CLM1B-BKW-CTaUb363	120	280	710	B3	460	B6	480
Blue	CLM1B-BKW-CTbUb453	120	355	710	B4	465	B5	475

Color	Kit Number	Viewing Angle	Luminous Intensity (mcd)		Dominant Wavelength			
			Min.	Max.	Color Bin	Min. (nm)	Color Bin	Max. (nm)
Green	CLM1B-GKW-CVaXa7a3	120	710	2240	G7	520	Ga	540
Green	CLM1B-GKW-CVbXa793	120	900	2240	G7	520	G9	535
Green	CLM1B-GKW-CWaXa793	120	1120	2240	G7	520	G9	535

Notes:

1. The above kit numbers represent order codes that include multiple intensity-bin and color-bin codes. Only one intensity-bin code and one color-bin code will be shipped on each bulk. Single intensity-bin code and single color-bin codes will not be orderable.
2. Please refer to the "Cree LED Lamp Reliability Test Standards" document for reliability test conditions.
3. Please refer to the "Cree LED Lamp Soldering & Handling" document for information about how to use this LED product safely.

GRAPHS

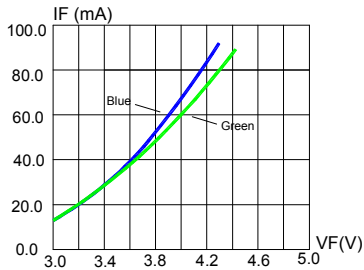

FIG.1 FORWARD CURRENT VS. FORWARD VOLTAGE.

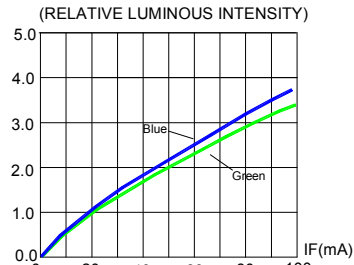

FIG.2 RELATIVE LUMINOUS INTENSITY VS. FORWARD CURRENT

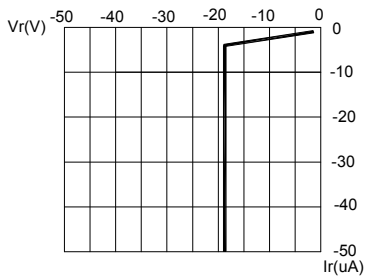

FIG.3 BLUE&GREEN REVERSE CURRENT VS. REVERSE VOLTAGE.

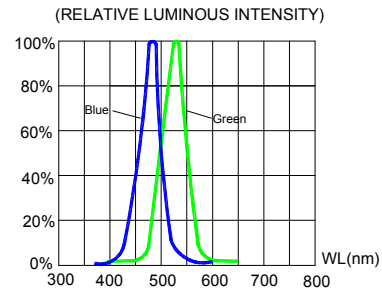

FIG.4 RELATIVE LUMINOUS INTENSITY VS. WAVELENGTH.

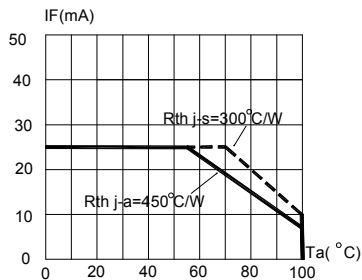

FIG.5 BLUE&GREEN MAXIMUM FORWARD DC CURRENT VS AMBIENT TEMPERATURE ($T_{jmax}=110^{\circ}C$)

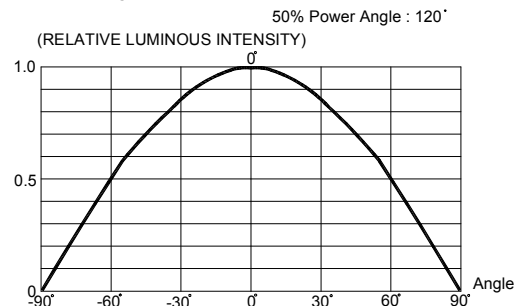
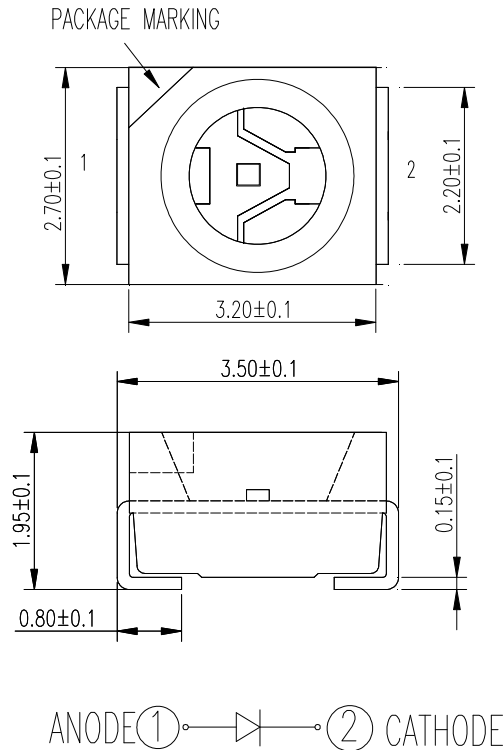

FIG.6 FAR FIELD PATTERN

The above data are collected from statistical figures that do not necessarily correspond to the actual parameters of each single LED. Hence, these data will be changed without further notice.

MECHANICAL DIMENSIONS

All dimensions are in mm.



NOTES

RoHS Compliance

The levels of environmentally sensitive, persistent biologically toxic (PBT), persistent organic pollutants (POP), or otherwise restricted materials in this product are below the maximum concentration values (also referred to as the threshold limits) permitted for such substances, or are used in an exempted application, in accordance with EU Directive 2002/95/EC on the restriction of the use of certain hazardous substances in electrical and electronic equipment (RoHS), as amended through April 21, 2006.

Vision Advisory Claim

Users should be cautioned not to stare at the light of this LED product. The bright light can damage the eye.

KIT NUMBER SYSTEM

Cree LED lamps are tested and sorted into performance bins. A bin is specified by ranges of color, forward voltage, and brightness. Sorted LEDs are packaged for shipping in various convenient options. Please refer to the "Cree LED Lamp Packaging Standard" document for more information about shipping and packaging options.

Cree LEDs are sold by order codes in combinations of bins called kits. Order codes are configured in the following manner:



