

1. Scope of Application

These specifications are applied to the chip type LED lamp , model CLL600-0101A1-27AM1A2

2. Part code

CLL600-0101A1-27AM1A2

[1]
[2]
[3]
[4]
[5]
[6]
[7]

[1]Series

CLL : LED for general lighting

[2]Outline dimensions

600 : 2.0(L) x 0.8(W) x 0.9(H)

[3]Dies in series quantity

01 : 1

[4]Dies in parallel quantity

01 : 1

[5]Correlated color temperature

27 : 2700K

[6]Chromaticity range

A : ANSI C78,377-2008

[7]CRI

M1 : Ra Min 80 Type

Symbol	CITILED
Name	CLL600-0101A1-27AM1A2
CITIZEN ELECTRONICS CO.,LTD. JAPAN	

3. Outline drawing

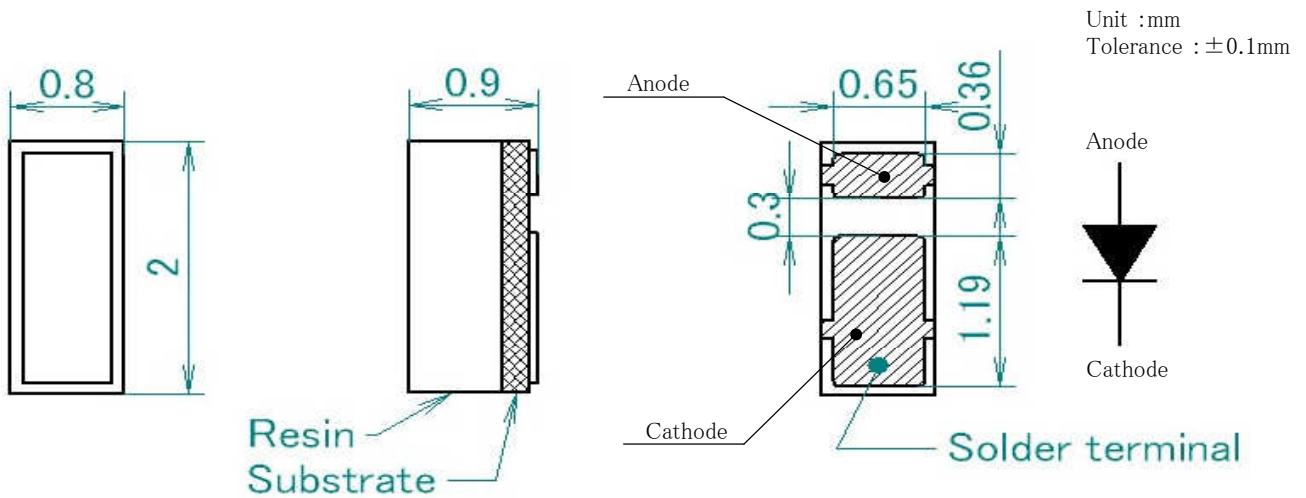

4. Performance

(1) Absolute Maximum Rating

Parameter	Symbol	Rating Value	Unit
Power Dissipation	P_D	340	mW
Forward Current	I_F	100	mA
Forward Pulse Current	I_{FP}	120	mA
Reverse Voltage	V_R	5	V
Operating Temperature	T_{OP}	-30 ~ +85	C
Storage Temperature	T_{ST}	-40 ~ +100	C
Junction Temperature	$T_{j\ Max}$	120	C

*1 Forward Current : Duty≤1/10 , Pulse Width≤10msec

*2 D.C. Current : $T_j = T_c + R_{j-c} \times P_D$

Pulse Current : $T_j = T_c + R_{j-c} \times P_w(\text{Power Dissipation / One-Pulse}) \times \text{Duty}$

*Ts : Solder terminal(Anode)temperature

Symbol	CITLED
Name	CLL600-0101A1-27AM1A2
CITIZEN ELECTRONICS CO.,LTD. JAPAN	

(2) Electro-optical Characteristics

Ts=25C

Parameter	Symbol	Condition	Min.	Typ.	Max.	Unit
Forward Voltage	V _F	I _F =80mA	2.9	3.2	3.5	V
Reverse Current	I _R	V _R =5V	-	-	100	μA
Thermal Resistance	R _{j-s} ^{*1}	Junction-solder	-	90	-	C/W
Luminous Flux	φ _V	I _F =80mA	17.6	23.5	29.4	lm
General Color Rendering Index	R _a	I _F =80mA	80	85	-	-

*1 Thermal Resistance : Junction - Solder terminal (Anode)

Ranking (Condition : I_F=80mA , Ts=25C)

Parameter	Symbol	Rank	Min.	Max.	Unit
Forward Voltage	V _F	Q	2.9	3.1	V
		R	3.1	3.3	
		S	3.3	3.5	
Luminous Flux	φ _v	B	17.6	21.5	lm
		C	21.5	25.5	
		D	25.5	29.4	

Chromaticity coordinates (Condition : I_F=80mA , Ts=25C)

Color Rank	x	y	色度ランク	x	y
1	0.4688	0.4290	2	0.4813	0.4319
	0.4562	0.4260		0.4688	0.4290
	0.4468	0.4077		0.4585	0.4104
	0.4585	0.4104		0.4703	0.4132

Color Rank	x	y	色度ランク	x	y
3	0.4585	0.4104	4	0.4703	0.4132
	0.4468	0.4077		0.4585	0.4104
	0.4373	0.3893		0.4483	0.3919
	0.4483	0.3919		0.4593	0.3944

*1 The tolerance of measurement at our tester is VF±3% , φ_v±7% , Chromaticity(x,y)±0.01 delivered.

Except designation of a delivery proportion of each rank.

Symbol	CITILED
Name	CLL600-0101A1-27AM1A2
CITIZEN ELECTRONICS CO.,LTD. JAPAN	

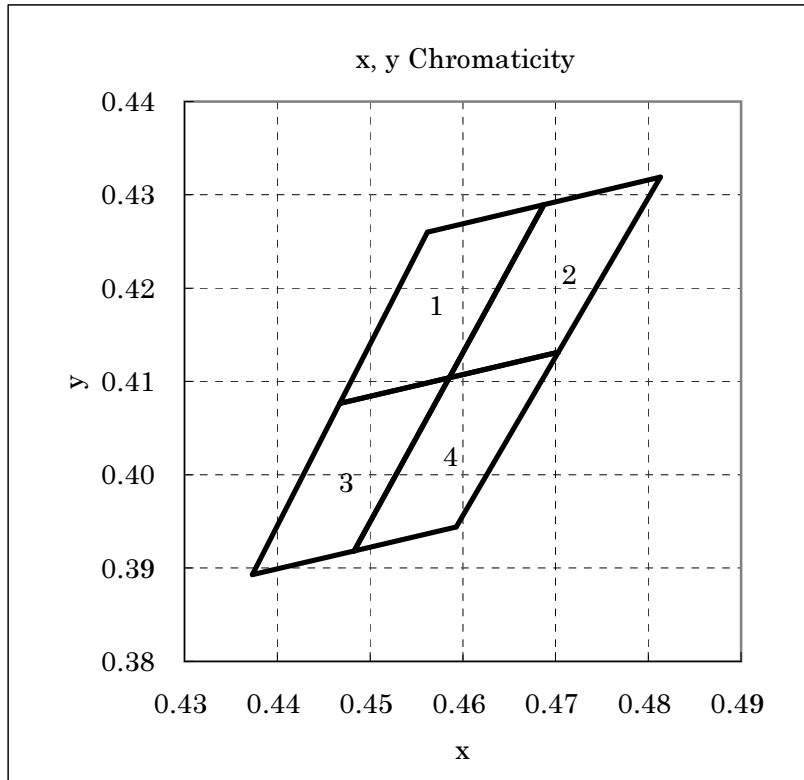

Symbol	CITILED
Name	CLL600-0101A1-27AM1A2
CITIZEN ELECTRONICS CO.,LTD. JAPAN	

5. Characteristics

•Forward Current vs. Forward Voltage

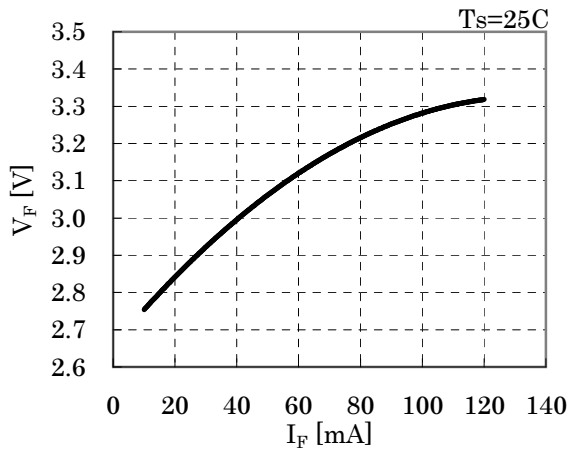

•Forward Current vs. Relative Luminous Intensity

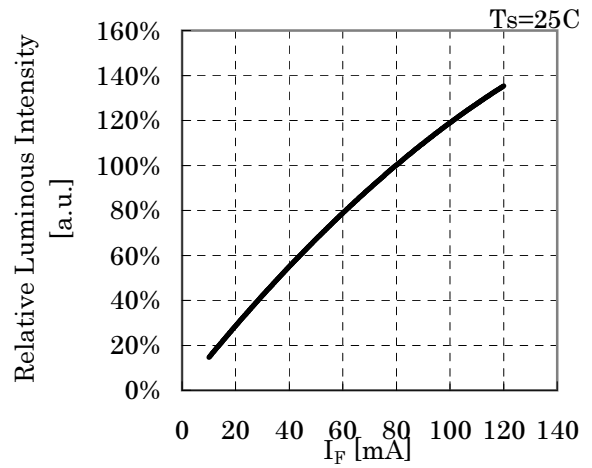

•Forward Current vs. Chromaticity Coordinate

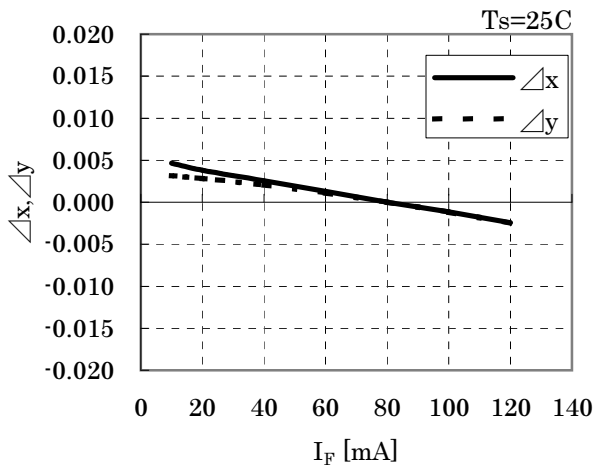

•Solder Temperature vs. Chromaticity Coordinate

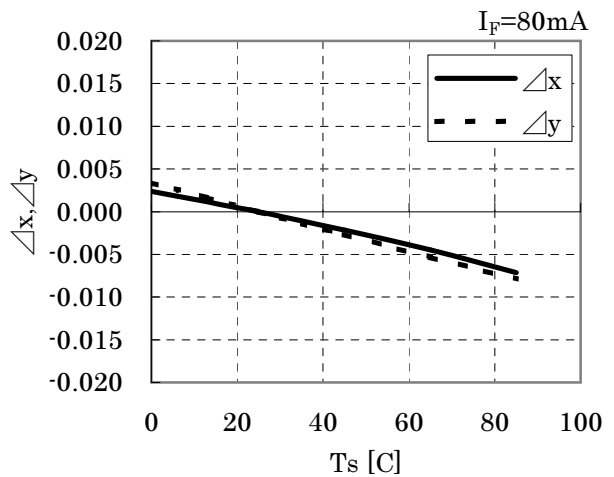

•Solder Temperature vs. Forward Voltage

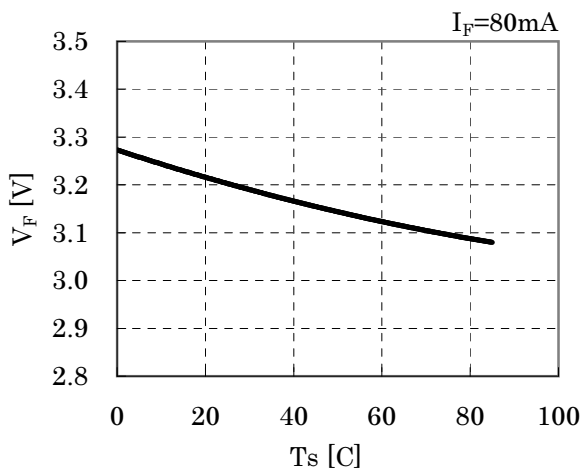

•Solder Temperature vs. Relative Luminous Intensity

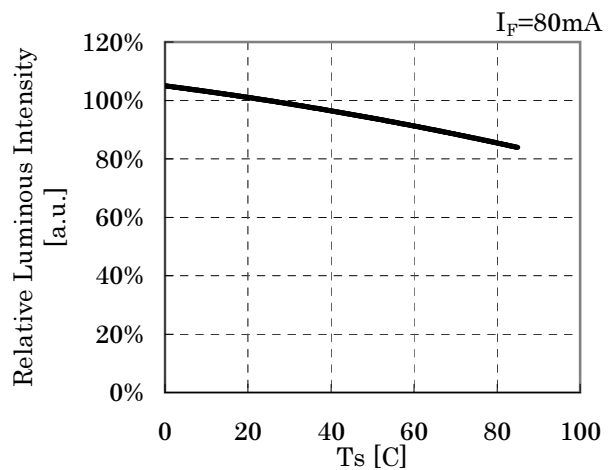

Symbol	CITILED
Name	CLL600-0101A1-27AM1A2
CITIZEN ELECTRONICS CO.,LTD. JAPAN	

•Solder Temperature vs. Allowable Forward Current

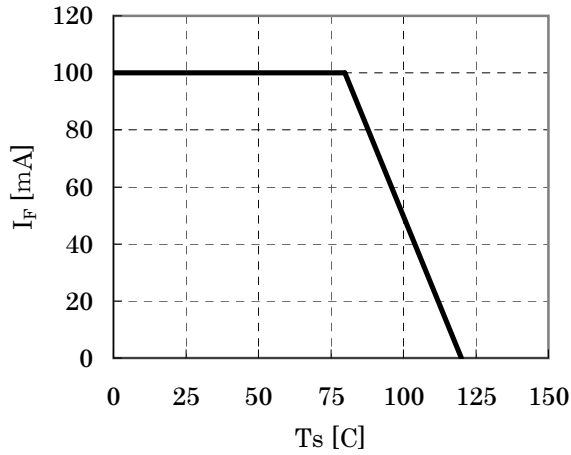

•Spectrum

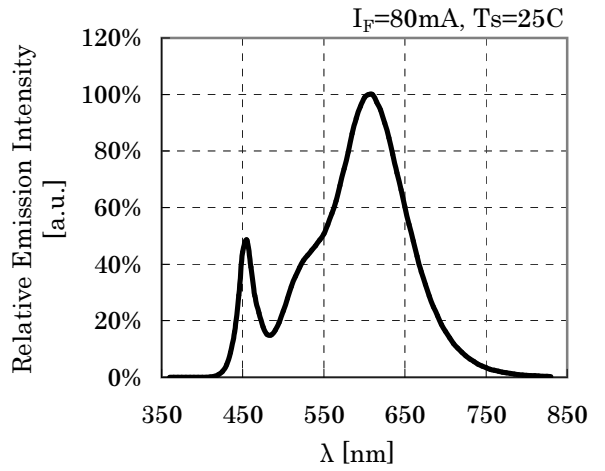

•Directive Characteristic

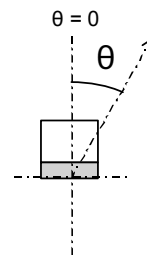
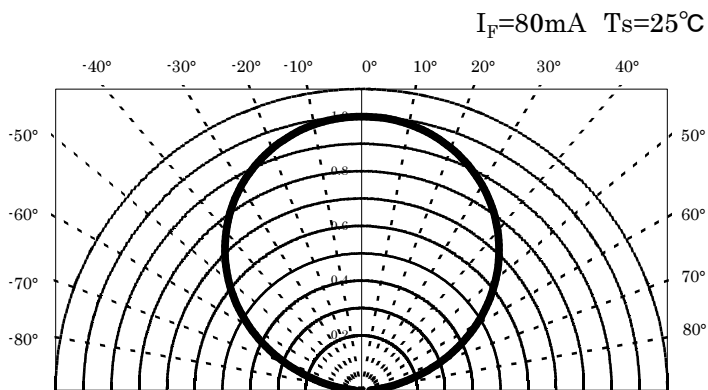
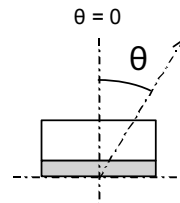
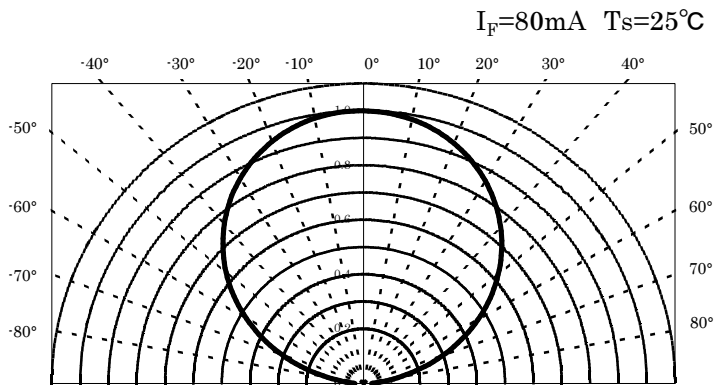

LED chip is mounted on White color PCB.

Symbol	CITILED
Name	CLL600-0101A1-27AM1A2
CITIZEN ELECTRONICS CO.,LTD. JAPAN	

6. Reliability

(1) Details of the tests

Test Item	Test Condition
Continuous Operation Test	Ta=60C, I _F =80mA , 1000 hours(with Al-fin)
	Ta=80C, I _F =80mA , 1000 hours(with Al-fin)
Low Temperature Storage Test	Ta=-40C , 1000 hours
High Temperature Storage Test	Ta=100C, 1000 hours
Moisture-proof Test	Ta=60C, 90%RH, 1000 hours
Thermal Shock Test	Ta=-40C 30minutes~100C 30minuets, 100cycle

(2) Judgment Criteria of Failure for Reliability Test

Ta=25C

Measuring Item	Symbol	Measuring Condition	Judgment Criteria for Failure
Forward Voltage	V _F	I _F =80mA	> U×1.2
Reverse Current	I _R	V _F =5V	> U×2
Luminous Flux	φ V	I _F =80mA	< S×0.7

U defines the upper limit of the specified characteristics. S defines the initial value.

Symbol	CITILED
Name	CLL600-0101A1-27AM1A2
CITIZEN ELECTRONICS CO.,LTD. JAPAN	

7. Taping Specifications (in accordance with JIS standard)

(1) Shape and Dimensions of Reel

(Unit: mm)

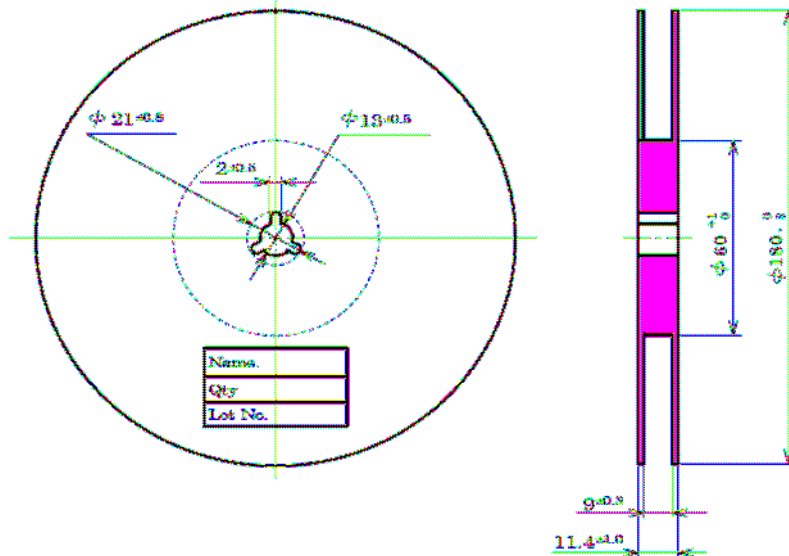

(2) Dimensions of Tape

(Unit: mm)

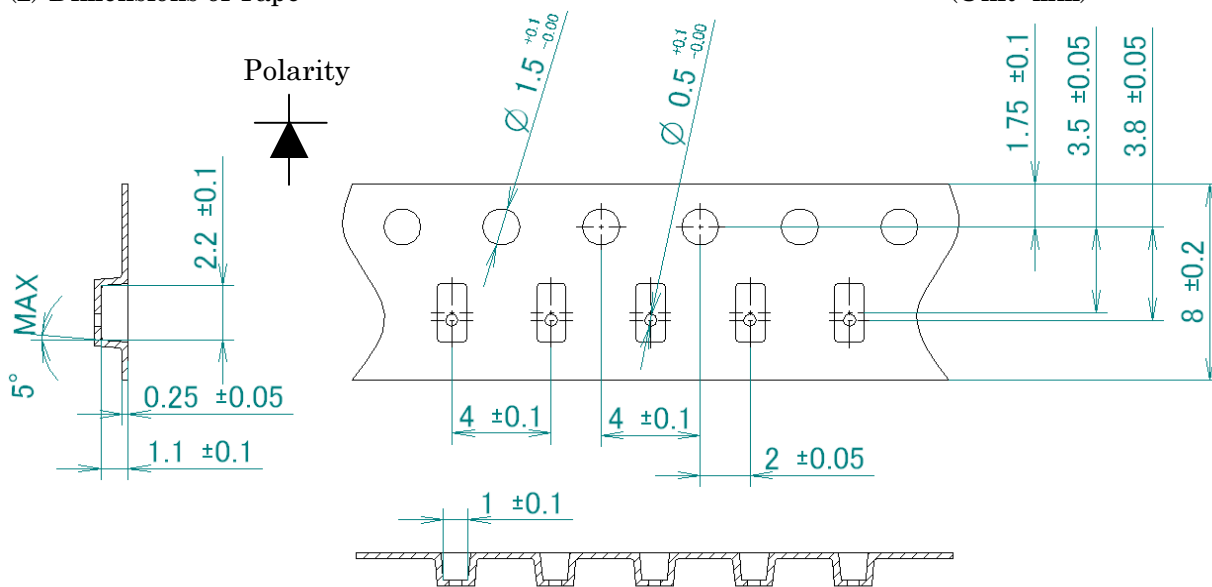

(3) Configuration of Tape

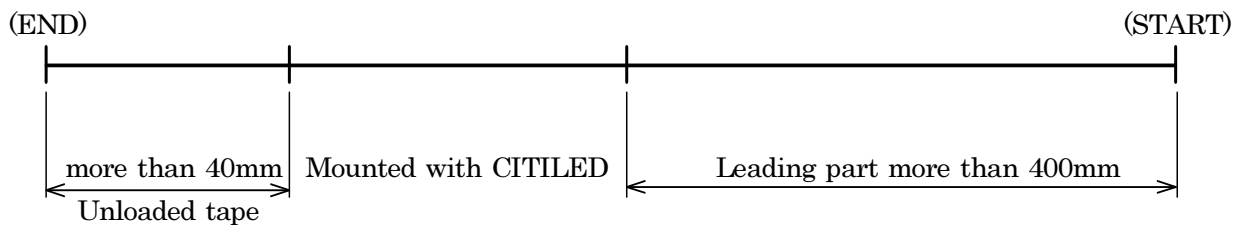

(4) Quantity: 2500pcs/reel

Symbol	CITILED
Name	CLL600-0101A1-27AM1A2
CITIZEN ELECTRONICS CO.,LTD. JAPAN	

8. Packing Specifications

8-1. Moisture-proof Packing

To prevent moisture absorption during transportation and storage, reels are packed in aluminum envelopes which contain a desiccant with a humidity indicator.

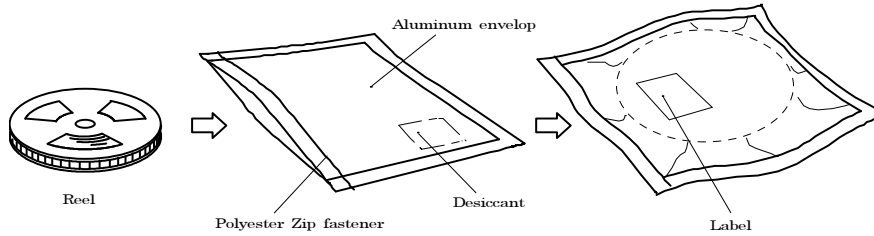

8-2. Storage

To prevent moisture absorption, it is strongly recommended that reels (in bulk or taped) should be stored in the dry box (or the desiccator) with a desiccant as the appropriate storage place. If not, the following is recommended.

Temperature : 5~30C
 Humidity : 60%RH max.

The devices should be mounted as soon as possible after unpacking. If you store the unpacked reels, please store them in the dry box or seal them into the envelop again.

Symbol	CITILED
Name	CLL600-0101A1-27AM1A2
CITIZEN ELECTRONICS CO.,LTD. JAPAN	

9. Precautions

9-1. Soldering

(1) Lead free soldering

1) Following soldering paste is recommended

Melting temperature : 216 ~ 220C.

Composition : Sn 3.5Ag 0.75Cu

2) The temperature profile at the top surface of the parts is recommended as shown below.

3) It is requested that products should be handled after their temperature has dropped down to the normal room temperature

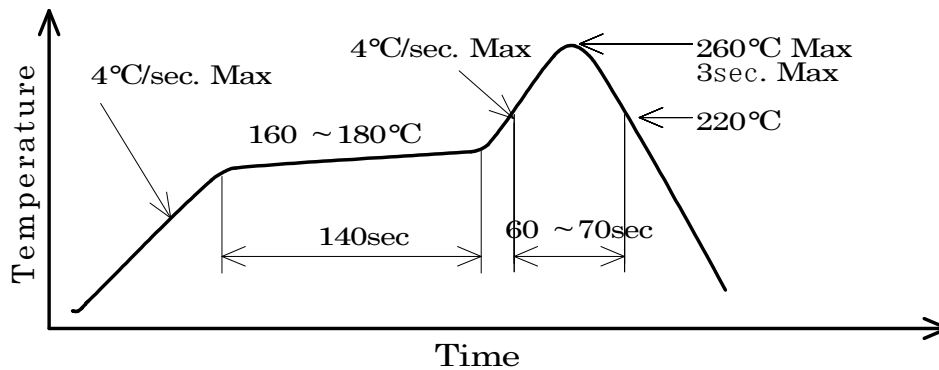

9-2. Washing

(1) When washing after soldering is needed, following conditions are requested.

a) Washing solvent: Pure Water

b) Temperature, time: 50C or less × 30 seconds max.

Symbol	CITLED
Name	CLL600-0101A1-27AM1A2
CITIZEN ELECTRONICS CO.,LTD. JAPAN	

9-3. Eye Safety

- The International Electrical Commission (IEC) published in 2006 IEC 62471 *"2006 Photobiological safety of lamps and lamp systems"* which includes LEDs within its scope. When sorting single LEDs according to IEC 62471, most LEDs can be classified as belonging to either Exempt Group or Risk Group 1.
- Optical characteristics of LEDs such as radiant flux, spectrum and light distribution are factors that affect the risk group determination of the LED, and especially a high-power LED, that emits light containing blue wavelengths, may have properties equivalent to those of Risk Group 2.
- Great care should be taken when directly viewing an LED that is driven at high current, has multiple uses as a module or when focusing the light with optical instruments, as these actions may greatly increase the hazard to your eyes.
- In addition, LED sources that were included within the scope of IEC 60825-1 / Edition 1.2 "laser safety standard", published 2001 were removed from the scope of the IEC 60825-1 / Edition 2.0 revised 2007.
- However, keep in mind that some countries and regions have adopted standards based on the IEC laser safety standard IEC 60825-1:2001 which includes LEDs within its scope.

9-4. Other directions

- (1) It is requested to avoid any stress added to the resin portion while it is heated.
- (2) It is requested to avoid any friction by sharp metal nail etc. to the resin portion.
- (3) If the product might to be used under the following conditions, the customer must evaluate its appropriateness them. This product is not designed for use under the following conditions in places where the product might:
 - get wet due to rain
 - suffer from damage caused by salt.
 - be exposed to corrosive gas such as Cl, H2S, NH3, SO2, Nox and so on.
 - be exposed to dust, fluid or oil.

Symbol	CITILED
Name	CLL600-0101A1-27AM1A2
CITIZEN ELECTRONICS CO.,LTD. JAPAN	

10. Designing precautions

1. The current limiting resistor should be placed in the circuit so that is driven within its rating. Also avoid reverse voltage (over-current) applied instantaneously when ON or OFF.
2. When pulse driving current is applied, average current consumption should be within the rating. Also avoid reverse voltage applied when put off.
3. Recommended soldering pattern

< For reflow soldering >

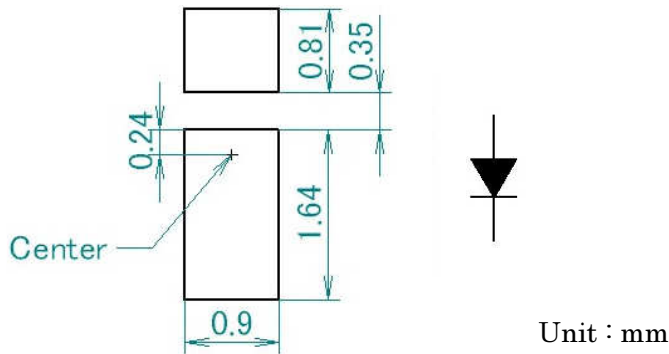

Mountability and solderability need to be optimized with actual conditions such as amount of solder, reflow temperature applied in the process.

4. When assembling the circuit board into the finished products, care must be taken to avoid the component parts from touching other parts.
5. When using multiple LEDs, it is required to connect a current limiting resistor on each path which the current flows to the LEDs.

(ex-1)

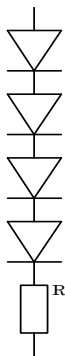

(ex-2)

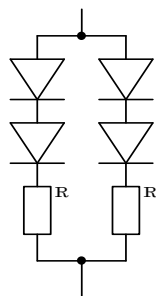

(ex-3)

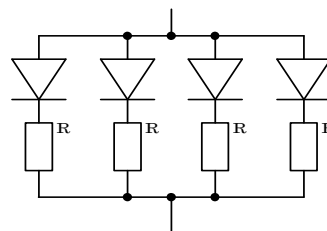

6. Other

This product complies with RoHS directives.

Symbol	CITILED
Name	CLL600-0101A1-27AM1A2
CITIZEN ELECTRONICS CO.,LTD. JAPAN	

11. Precautions with regard to product use

1. This document is provided for reference purposes only so that CITIZEN ELECTRONICS' products are used as intended. CITIZEN ELECTRONICS neither makes warranties or representations with respect to the accuracy or completeness of the information contained in this document nor grants any license to any intellectual property rights or any any other rights of CITIZEN ELECTRONICS or any third party with respect to the information in this document.
2. All information included in this document such as product data, diagrams, charts, is current as of the date this document is issued.
Such information, however, is subject to change without any prior notice.
Before purchasing or using any CITIZEN ELECTRONICS' products listed in this document, please confirm the latest product information with a CITIZEN ELECTRONICS' sales office, and formal specifications must be exchanged and signed by both parties prior to mass production.
3. CITIZEN ELECTRONICS has used reasonable care in compiling the information included in this document, but CITIZEN ELECTRONICS assumes no liability whatsoever for any damages incurred as a result of errors or omissions in the information included in this document.
4. Absent a written signed agreement, except as provided in the relevant terms and conditions of sale for product, and to the maximum extent allowable by law, CITIZEN ELECTRONICS assumes no liability whatsoever, including without limitation, indirect, consequential, special, or incidental damages or loss, including without limitation, loss of profits, loss of opportunities, business interruption and loss of data, and disclaims any and all express or implied warranties and conditions related to sale, use of product, or information, including warranties or conditions of merchantability, fitness for a particular purpose, accuracy of information, or no infringement.
5. Though CITIZEN ELECTRONICS works continually to improve products' quality and reliability, products can malfunction or fail. Customers are responsible for complying with safety standards and for providing adequate designs and safeguards to minimize risk and avoid situations in which a malfunction or failure of a product could cause loss of human life, bodily injury or damage to property, including data loss or corruption.
In addition, customers are also responsible for determining the appropriateness of use of any information contained in this document such as application cases not only with evaluating by their own but also by the entire system.
CITIZEN ELECTRONICS assumes no liability for customers' product design or applications.
6. Please contact CITIZEN ELECTRONICS' sales office if you have any questions regarding the information contained in this document, or if you have any other inquiries.

Symbol	CITILED
Name	CLL600-0101A1-27AM1A2
CITIZEN ELECTRONICS CO.,LTD. JAPAN	